

**EFFICIENCY OF WASTEWATER
TREATMENT BY LAND DISPOSAL AND ITS EFFECTS
ON CROP PRODUCTIVITY**

by

BEYZA ÜSTÜN

B.S. in C.E., Anadolu University, 1981

Bogazici University Library



39001100314809

14

Submitted to the Institute for Graduate Studies
in Science and Engineering in partial fulfillment
of the requirements for the degree of Master of
Science in **Environmental Engineering**

FOR REFERENCE

NOT TO BE TAKEN FROM THIS ROOM

EFFICIENCY OF WASTEWATER
TREATMENT BY LAND DISPOSAL AND ITS EFFECTS
ON CROP PRODUCTIVITY

APPROVED BY

Doç. Dr. Fahir BORAK

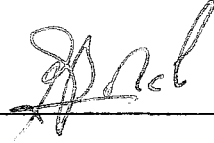

Doç. Dr. Kriton CURİ
(Thesis Supervisor)



Dr. Ufuk SEBÜKTEKİN

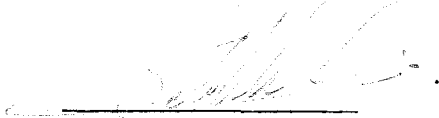

Date of Approval

TABLE OF CONTENTS

	<u>Page</u>
ACKNOWLEDGEMENT	i
ABSTRACT	ii
ÖZET	iii
LIST OF TABLES	iv
LIST OF FIGURES	v
I. INTRODUCTION	1
II. LITERATURE REVIEW	2
2.1. History of Land Treatment	2
2.2. Types of Systems of Land Treatment of Wastewater	2
2.2.1. Irrigation	4
2.2.2. Rapid Infiltration	4
2.2.3. Over Land Flow	6
2.3. Advantages and Disadvantages of Land Treatment of Wastewater	7
2.4. Signification Parameters Related to the Use of Wastewater for Irrigation Purposes	8
2.4.1. Nutrients in Wastewater	9
2.4.2. Sodium Absorption Ratio (SAR)	9
2.4.3. Trace Elements	11
2.4.4. Miscellaneous Problems	11
2.5. Side Characteristics	12
2.5.1. Slope	12

	<u>PAGE</u>
2.5.2. Soil Characteristics	14
2.5.2.1. Physical Characteristics of Soil	14
2.5.2.2. Hydraulic Characteristics of Soil	15
2.5.2.3. Chemical Characteristics of Soil	16
2.6. Crop Selection	16
2.7. Nutrient Removal	17
2.7.1. Nitrogen Removal	17
2.7.2. Phosphorus Removal	18
 III. EXPERIMENTAL SET-UP PROCEDURE AND RESULTS	 20
3.1. The Land Disposal Study	
3.1.1. Experimental Set-up	20
3.1.2. Experimental Procedure	31
3.1.2.1. The Porous Media	31
3.1.2.2. The Wastewater	36
3.1.3. Experimental Results	36
3.1.3.1. Chemical Oxygen Demand (COD)	37
3.1.3.2. Nitrogen (N)	44
3.1.3.3. Phosphorus (P)	54
3.1.3.4. Solids	54
3.1.3.5. Turbidity	63
3.1.3.6. pH	63
3.1.3.7. Coliform	63
3.2. Crop Productivity	72
3.2.1. Procedure	72
3.2.2. Results	77
 IV. DISCUSSION AND CONCLUSION	 96
 V. RECOMMENDATION FOR FUTURE STUDIES	 97
REFERENCES	98
APPENDIX A :Details of the Channel and the Porous Media	101
APPENDIX B :Results of Experiments	104

ACKNOWLEDGEMENT

I am grateful for the generous advice, guidance, encouragement to the supervisor of my thesis, Doç. Dr. Kriton CURI who helped me through research studies with his fine cooperation and support.

I am thankful to Doç. Dr. Dogan KANTARCI and Mr. Tahir YALABIK for their assistance in my study on crop productivity.

I also thank Miss. Günay KOCASOY for the generous help and advice about chemical analysis.

I would also like to pay an affectionate tribute to my husband, M. Emin ÇOMAKOĞLU, and my parents, Neşe and Lütfi ÜSTÜN, for the generous support and encouragement they gave throughout my graduate work.

Beyza Üstün

July, 1985

ABSTRACT

Land application of wastewater is one of the oldest methods used for treatment and disposal of wastes. The main advantages of this technique are the low initial and maintenance costs involved, high Nutrient recycle capacity, and the increase of crop growth.

Because of these factors it is believed that land disposal is an advantageous technique for developing countries and is strongly recommended for the rural areas of Turkey.

in 1984 , a 25 meters long channel was constructed by A.Baysal in Boğaziçi University's Garden. These channels were filled with sand and gravel, domestic wastewater was applied. The variation of wastewater characteristics with time, distance and effective size of media were investigated through out the application period in 1985.

Removal efficiencies obtained are given below:

Chemical Oxygen Demand(COD)	76% in the Sand bed for 35 days 60% in the Gravel bed for 35 days
Nitrogen (N)	70% in the Sand bed for 35 days 57% in the Gravel bed for 35 days
Phosphorus (P)	77% in the Sand bed for 35 days 64% in the Gravel bed for 35 days

The study of crop productivity has been performed at Faculty of Forest of Istanbul University. Its aim was to examine the crop productivity of the media through which wastewater has been disposed. The best result was obtained from a mixture containing 80% of the media and 20% of soil.

ÖZET

Atıksuyun araziye verilmesi atıkların bertaraf edilmesi ve arıtılması sırasında kullanılan en eski yöntemlerden biridir. Bu tekniğin önemli avantajları, yatırım ve bakım masraflarının düşüklüğü, besin maddesi (azot ve fosfor) geri kazanılması ve bitki üretimindeki verimdir.

Tüm bu faktörler nedeniyle arazide arıtım gelişen ülkeler için avantajlı bir tekniktir, özellikle Türkiye'nin kırsal kesimi için tavsiye edilir.

1984 senesinde Boğaziçi Üniversitesi'nin Bahçesine 25 m. uzunluğunda kanallı inşaat ettirildi. Bu kanallar kum ve çakıl ile dolduruldu ve içinden atıksu geçirildi. 1985 de zamana, mesafeye ve malzemenin efektif çapına göre atıksuyun karakterindeki değişiklikler gözlemlendi.

Arıtmadan elde edilen veriler yüzde olarak aşağıda verilmiştir.

Kimyasal Oksijen İhtiyacı (KOF)	35günde Kum ortamda	%76
	" Çakıl "	%60
Azot (N)	" Kum "	%70
	" Çakıl "	%57
Fosfor (P)	" Kum "	%77
	" Çakıl "	%64

Bitki üretimle ilgili olan çalışma İstanbul Üniversitesi Orman Fakültesinde gerçekleştirildi. Atıksu geçirilmiş ortamın bitki üretimine etkisi araştırıldı. En iyi sonuç %80 karışımli malzemenin alındı. Bu malzemenin %80'i içinden pis su geçirilmiş kum %20'si ise verimsiz topraktır.

LIST OF TABLES

	<u>PAGE</u>
TABLE 1 : Selected Early Land Treatment Systems	3
TABLE 2 : Comparison of the Effectiveness of Pollutant Removal of Spray Irrigation and Rapid Infiltration	6
TABLE 3 : Required Quality for Irrigation Water	10
TABLE 4 : Recommended Maximum Concentration of Trace Elements in Irrigation Water	11
TABLE 5 : Soil Permeability Classes	15
TABLE 6 : Crop Uptake of Nutrients	19
TABLE 7 : Plantation Sets	69

LIST OF FIGURES

	<u>PAGE</u>
FIGURE 1 : Surface Irrigation	5
FIGURE 2 : Sprinkler Irrigation	5
FIGURE 3 : Textural Classes	13
FIGURE 4a: Top View of the System	21
FIGURE 4b: Side View of the System	21
FIGURE 5 : The View of the Channels and the Outlet Tank	24
FIGURE 6a: Cross-Sectional View of the Inlet Tank	23
FIGURE 6b: Cross-Sectional View of the Outlet Tank	23
FIGURE 7 : Photograph of the Inlet Tank	24
FIGURE 8 : Photograph of Inlets	25
FIGURE 9 : Photograph of the Iron Plate	25
FIGURE 10a: Top View of the Channel	26
FIGURE 10b: Longitudinal Cross-Section of the Channel	26
FIGURE 11: Photograph of the Concrete Wall at the End of the Channels	28
FIGURE 12: Photograph of the Outlet Tank	28
FIGURE 13a: The Inlet Cross-Sectional View of the Channels	30
FIGURE 13b: The Outlet Cross-Sectional View of the Channels	30
FIGURE 14: The Granulometric Curves of Sand	32
FIGURE 15: The Granulometric Curves of Gravel	33
FIGURE 16: The Channel Full with Sand	34
FIGURE 17: The Channel Full with Gravel	34
FIGURE 18: Graphical Presentation Showing the Variation of COD with Time in the Channel Full with Sand	35
FIGURE 19: Graphical Presentation Showing the Removal Efficiency of COD with Distance in the Channel Full with Sand	38

	<u>PAGE</u>
FIGURE 20 : Graphical Presentation showing the Removal Efficiency of COD with Time in the Channel Full with Sand	39
FIGURE 21 : Graphical Presentation Showing the Variation of COD with Distance in the Channel Full with Sand	40
FIGURE 22 : Graphical Presentation Showing the Variation of COD with Time in the Channel Full with Gravel	41
FIGURE 23 : Graphical Presentation Showing the Removal Efficiency of COD with Time in the Channel Full with Gravel	42
FIGURE 24 : Graphical Presentation Showing the Removal Efficiency of COD with Distance in the Channel Full with Gravel	43
FIGURE 25 : Graphical Presentation Showing the Variation of COD with Distance in the Channel Full with Gravel	45
FIGURE 26 : Graphical Presentation Showing the Variation of COD Removal Efficiency with Effective Size of Porous Media	46
FIGURE 27 : Graphical Presentation Showing the Variation of Nitrogen with Time in the Channel Full with Sand	47
FIGURE 28 : Graphical Presentation Showing the Removal Efficiency of Nitrogen with Distance in the Channel Full with Sand	48
FIGURE 29 : Graphical Presentation Showing the Variation of Nitrogen with Distance in the Channel Full with Sand	49

	<u>PAGE</u>
FIGURE 30 : Graphical Presentation Showing the Removal Efficiency of the Nitrogen with Time in the Channel Full with Sand	50
FIGURE 31 : Graphical Presentation Showing the Removal Efficiency of Nitrogen with Time in the Channel Full with Gravel	50
FIGURE 32 : Graphical Presentation Showing the Variation of Nitrogen with Time in the Channel Full with Gravel	51
FIGURE 33 : Graphical Presentation Showing the Removal Efficiency of Nitrogen with Distance in the Channel Full with Gravel	51
FIGURE 34 : Graphical Presentation Showing the Variation of Nitrogen with Distance in the Channel Full with Gravel	52
FIGURE 35 : Graphical Presentation Showing the Removal Efficiency of Nitrogen with the Effective Size of The Porous Media	53
FIGURE 36 : Variation of Phosphorus with Distance in the Channel Full with Sand	55
FIGURE 37 : Removal Efficiency of Phosphorus with Distance in the Channel Full with Sand	56
FIGURE 38 : Variation of Phosphorus with Time in the Channel Full with Sand	57
FIGURE 39 : Removal Efficiency of Phosphorus with Time in the Channel Full with Sand	58
FIGURE 40 : Variation of Phosphorus with Distance in the Channel Full with Gravel	59
FIGURE 41 : Removal Efficiency of Phosphorus with Time in the Channel Full with Gravel	60

	<u>PAGE</u>
FIGURE 42 : Removal Efficiency of Phosphorus with Distance in the Channel Full with Gravel	60
FIGURE 43 : Variation of Phosphorus with Time in the Channel Full with Gravel	61
FIGURE 44 : Removal Efficiency of Phosphorus with Effective Size of Porous Media	62
FIGURE 45a: Removal Efficiency of Total Solids in the Channel Full with Gravel	64
FIGURE 45b: Removal Efficiency of Total Solids in the Channel Full with Sand	64
FIGURE 46 : Variation of Turbidity with Time in the Channel Full with Sand	65
FIGURE 47 : Removal of Turbidity with Time in the Channel Full with Sand	65
FIGURE 48 : Variation Turbidity with Distance in the Chan- nel Full Sand	66
FIGURE 49 : Removal Efficiency of Turbidity with Distance in the Channel Full with Sand	66
FIGURE 50 : Variation of Turbidity with Time in the Channel Full with Gravel	67
FIGURE 51 : Removal Efficiency of Turbidity with Time in the Channel Full with Gravel	67
FIGURE 52 : Variation of Turbidity fith Distance in the Chan- nel Full with Gravel	68
FIGURE 53 : Removal Efficiency of Turbidity with Distance in the Channel Full with Gravel	69
FIGURE 54 : Removal Efficiency of Turbidity with Effctive Size of Porous Media	69
FIGURE 55: Variation of pH with Distance in the Channel Full with Sand	70

	<u>PAGE</u>
FIGURE 56 : Variation of pH with Distance in the Channel Full with Gravel	71
FIGURE 57 : Variation of Total Coliform with Distance in Channel Full with Sand	73
FIGURE 58 : Removal Efficiency of Coliform with Distance in the Channel Full with Sand	73
FIGURE 59 : Variation of Coliform with Distance in the Channel Full with Gravel	74
FIGURE 60 : Removal Efficiency of Coliform with Distance in the Channel Full with Gravel	74
FIGURE 61 : Large Box	76
FIGURE 62 : Small Box	76
FIGURE 63 : Divided Box	76
FIGURE 64 : Relation Between the Crop Growth and Time	79
FIGURE 65 : Growing Efficiency of Stem with Time	80
FIGURE 66 : Relation Between Crop Growth and Composition of the Soil	81
FIGURE 67 : The Plantation	82
FIGURE 68 : Variation of Flower Diameter with Time	83
FIGURE 69 : Variation of the Diameter of Flower with Respect to Time	84
FIGURE 70 : Flowering Efficiency According to Composition of Mixture	85
FIGURE 71 : Variation of the Growth of the Plant Diameter with Time	86
FIGURE 72 : Variation of Plant Diameter with Respect to Composition of Mixture	87
FIGURE 73 : Variation of Growing Efficiency of Plant with Time	88
FIGURE 74 : Relation Between Root Length with Composition of Mixture	89

	<u>PAGE</u>
FIGURE 75 : Root Volume	90
FIGURE 76 : Variation of Root Growth Efficiency with Respect to Mixing Rate	91
FIGURE 77 : Variation of the Root Length, Root Width with Respect to the Composition of Mixture	91
FIGURE 78 : Variation of Root Volume with Respect to Stem Length	92
FIGURE 79 : Variation of the Root Volume with Respect to Total Weight of Plant	92
FIGURE 80 : Variation of the Root Volume with Respect to the Total Weight of the Plant above the Ground	93

I. INTRODUCTION

The basic purpose of land treatment is to recycle the water and nutrients contained in wastewaters for agricultural purposes while disposing wastewaters in a way acceptable from the public health point of view.

Most of the pollutants present in wastewater are removed as it passes through soil. Among these, phosphorus and nitrogen are used by plants which grow on these areas. By using this technique the need for fertilizers in a specific area decreases. Furthermore, wastewater reclamation has many other benefits, which are;

- reduced costs of wastewater treatment and disposal,
- reduction of the amount of pollutants in receiving water by diverting treated wastewater to land.

Although land treatment and disposal of wastewater has been practiced for centuries in the world, It has not yet been used in a knowledgable way in Turkey. It is belived that the present study, which is a continuation of studies conducted earlier in "Boğaziçi University" (Baysal, 1984; Curi, Baysal, Esen, 1984) will be a motivation for the initiation of land treatment practice in Turkey.

II. LITERATURE REVIEW

2.1 HISTORY OF LAND TREATMENT

Land application of wastewater is one of the oldest methods used for treatment and disposal of wastes. Even in classical years wastewater was disposed many times on land.

Table 1 shows some of the cities which have used this method starting from the second half of the nineteenth century.

In the U.S. in 1981, there were about 1300 industrial plants and about 950 municipalities using infiltration or crop irrigation to treat and dispose their sanitary sewage (Arceivala, 1981).

2.2 TYPES OF SYSTEMS OF LAND TREATMENT OF WASTEWATER

According to Metcalf and Eddy (1979), the types of land treatment of wastewater are classified as,

1. Irrigation (sprinkler or surface)
2. Rapid infiltration (usually surface)
3. Overland flow (sprinkler or surface)

4. Wetland application (sprinkler or surface)
5. Subsurface application (subsurface piping).

These systems are explained in detail by Arceivala (1981), Baysal (1984), Kocasoy (1985) and Sanks (et, al.,1976)

TABLE 1 - Selected Early Land Treatment Systems (Metcalf and Eddy, 1979)

Location	Date started	Type of system	Area (ha)
Berlin	1874	Sewage farm	2,720
Brounschweig	1896	"	4,400
Craydon-Beddington	1860	"	252
Leamington	1870	"	160
Melbourne	1893	Irrigation	4,160
Mexico-city	1900	"	44,800
Paris	1869	"	640
Wroclaw	1882	Sewage farm	800
Calumet City	1888	Rapid infiltration	4.8
Ely	1909	Irrigation	160
Fresno	1891	"	1,600
San Antonio	1895	"	1,600
Vineland	1901	Rapid infiltration	5.6
Woodland	1889	Irrigation	96

In the part which follows a short summary of these systems is given:

2.2.1 Irrigation

Irrigation is the predominant land treatment process. Wastewater is applied to the land and utilized in production of crops. This system has an optimum requirement of wastewater. Irrigation systems according to Arceivala (1981) can be classified as surface or gravity systems and sprinkler or pressure systems.

a. Surface Systems

This method is suitable for a wide range of soil textures, although generally it is preferred not to be used for fine textured soils with low intake rates. Land slopes may be up to 3%. Water is given from one end and enters the soil while flowing down through the ditch. Figure 1 is a schematic illustration of surface irrigation (Arceivala, 1981).

b. Sprinkler Irrigation

Sprinkler irrigation is a method in which wastewater is sprinkled on the soil and crops, thus uniform distribution like rain is secured. In this method water requirement is low but evaporation is high. Sprinklers are suitable for a rolling topography. Initial and operation costs are high. Figure 2 is a schematic illustration of sprinkler irrigation (EPA, 1979).

2.2.2 Rapid Infiltration

In rapid infiltration systems, wastewater is applied to the soil at high rates by sprinkling or spreading. Purification is achieved as

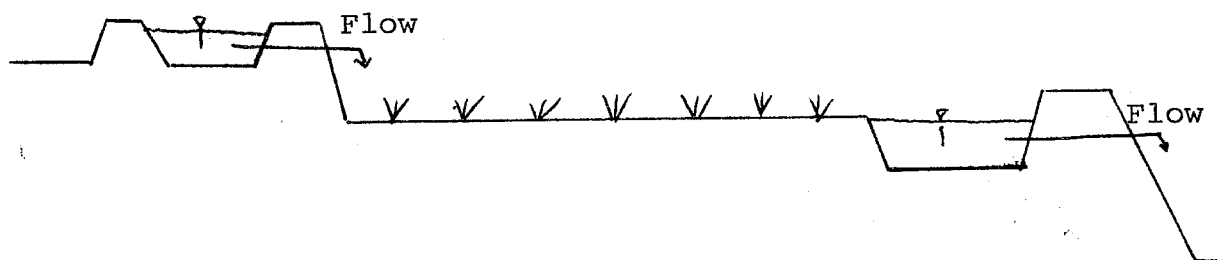

Figure 1 : Surface Irrigation

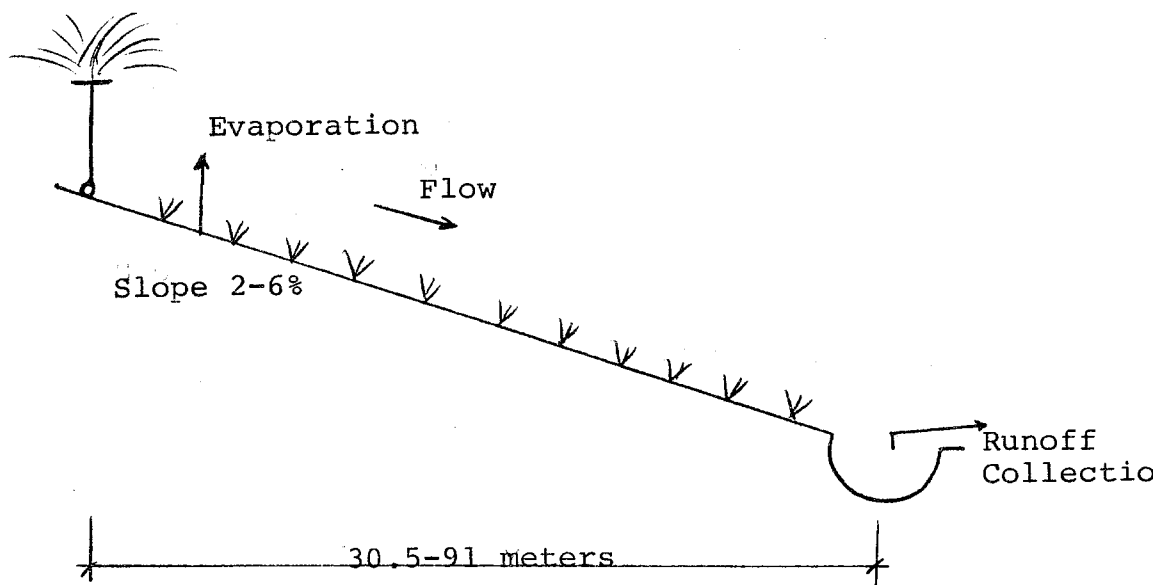

Figure 2 : Sprinkler Irrigation

the wastewater passes through the soil. By this type of application beyond the treatment of the wastewater, recharge of the ground water is realized. Table 2 shows comparison of the effectiveness of pollutant removal of spray irrigation and rapid infiltration.

2.2.3 Over Land Flow

This type of land treatment is a biological type of treatment process. Wastewater is applied over the upper reaches of sloped terraces and flows through the crop surface. Due to the fact that during high precipitation periods, soil cannot absorb all the water, storage should be provided especially for the winter season.

TABLE 2 - Comparison of the Effectiveness of Pollutant Removal of Spray Irrigation and Rapid Infiltration (Arceivala, 1981)

I T E M	Approximate efficiency of removal (%)	
	Spray Irrigation	Rapid Infiltration
BOD	99	99
SS	99	99
N	80-90	80
P	99	90
Heavy metals	99	95
Organic compounds	99	90
Bacteria	99	99

2.3 ADVANTAGES AND DISADVANTAGES OF LAND TREATMENT OF WASTEWATER

Land treatment as mentioned before has been practiced for centuries. During this period the following advantages and disadvantages have been observed (Arceivala, 1981; Baysal, 1984; Hernandez, 1979).

Advantages

1. Presence of fertilizing constituents.
2. Favorable soil conditioning properties.
3. Less amount of skilled persons.
4. Increasing crop growth.
5. High nutrient recycling capacity.
6. Lower cost in comparison to other methods.
7. Efficiency not affected shock loadings.
8. Lower initial capital investment needed.
9. Enlargement of green built areas and low density open space.
10. Potential for improved control of waste material by limiting dispersion and eliminating need for dilution water in receiving streams.

Disadvantages

1. Large area requirement.
2. Possibility of odour problems and mosquito nuisance.
3. Possible chemical affects of wastewater on the soil and groundwater and to crops.

4. Operation is difficult during winter conditions.
5. Loss of water with evapo-transpiration.
6. Some trace elements are danger for crop production and food chains.
7. Potential for concentration of nitrates in the shallow groundwater.

2.4 SIGNIFICANT PARAMETERS RELATED TO THE USE OF WASTEWATER FOR IRRIGATION PURPOSES

The main parameters which are of importance, related to the use of wastewater for irrigation purposes, are the following.

1. Nutrients available in wastewater.
2. Organic load in wastewater.
3. Salinity or electrical conductivity (EC).
4. Sodium absorption ratio (SAR) and existing and expected future concentration of salt in the soil.
5. Land treatment efficiency.
6. Groundwater pollution.
7. Trace elements.
8. Boron concentration and other miscellaneous problem.
9. Climate.

Furthermore in wastewater irrigation, the risk of methemoglobinemia in human infants should be considered. Nitrite absorbed into the blood stream can combine with hemoglobin; thereby reducing its capacity to carry

oxygen. This disease is known as "methemoglobinemia" or "blue baby disease". This disease is much more common in very young infants than older humans (F.E. Broadbent, et.al, 1984).

Some details for the most important of these parameters are given below.

2.4.1 Nutrients in Wastewater

Nitrogen, phosphorus, potassium, sulfur, calcium, magnesium and iron are known as macronutrients (Arceivala, 1981). Nitrogen secures leaf and stem growth. Phosphorus secures root growth. Potassium is utilized for the formation of Chlorophyll.

Manganese, boron, zinc, copper, molybdenum and chloride are known as micronutrients (Arceivala, 1981) and are minimal quantities in soil.

Some plants require all of the above mentioned nutrients; some others require only part of them.

2.4.2 Sodium Absorption Ratio (SAR)

All waters contain measurable quantities of dissolved salts. Increase in the salinity of the wastewater used for irrigation purposes results in increase of the problems related to quality of soil, groundwater and crop production efficiency. Crop yields may be decreased if irrigation over a prolonged period of time leads to high salt levels in the soil.

The sodium absorption ratio (SAR) is calculated by the following equation:

$$SAR = \frac{Na}{\sqrt{(Ca+Mg)/2}}$$

where Na, Ca, Mg are in Meq/L.

$$Na \text{ (Meq/L)} = \frac{Na \text{ (mg/L)}}{23}$$

$$Ca \text{ (Meq/L)} = \frac{Ca \text{ (mg/L)}}{20}$$

$$Mg \text{ (Meq/L)} = \frac{Mg \text{ (mg/L)}}{12.2}$$

TABLE 3 - Required Quality for Irrigation Water (Dennis and Ayers, 1984)

Parameter	Usual range in irrigation water
Total dissolved solids(mg/L)	0-2000
Calcium (mg/L)	0-400
Magnesium (mg/L)	0-60
Sodium (mg/L)	0-900
Boron (mg/L)	0-2
pH	6.5-8.5
SAR	0-15

The range of SAR values and of some other parameters of water or wastewater appropriate to be used for irrigation purposes are given in Table 3.

2.4.3 Trace Elements

Trace elements like cadmium, cobalt, chromium, etc. can accumulate in plants and in soil. These elements have toxic effects. Their long term build-up in the soil may cause health hazards to plants, animals and human beings. Table 4 shows these trace elements and their maximum concentration in irrigation water for crop growth (Dennis, et.al, 1984).

TABLE 4 - Recommended Maximum Concentration of Trace Elements in Irrigation Water (Dennis, et.al, 1984)

Element	Recommended Max. Concentration, (mg/L)
Al	5.8
As	0.10
Be	0.10
Cd	0.01
Co	0.05
Cr	0.10
Cu	0.20
Fe	5.00
Mn	0.20
Pb	5.00
Se	0.02

2.4.4 Miscellaneous Problems

The following problems may also be encountered in relation to irrigation with wastewater.

- a) Increase in boron concentration may cause reduction of yield.
- b) Low pH value of the wastewater used for irrigation purposes may cause corrosion problems in pipelines.
- c) Residual chlorine concentrations less than 1 mg/L do not affect plants. Values in excess of 5 mg/L may cause severe plant damage.

2.5 SITE CHARACTERISTICS

Slope, soil characteristics and soil permeability are among the most important parameters which effect the selection of a site to be used for wastewater irrigation.

Most soils are somewhere in between sand, silt and clay and are called "loams". According to Arceivala (1981), "Loamy sand" has 10-15% clay, "medium-loam" has 15-23% clay, "clay loam" has 23-35% clay. Soils with more than 35% clay behave like clay. Those with less than 10% clay, resemble sand. Texture has an important influence on the crop yields, because it effects the drainage characteristics and consequently the moisture content of soil. Soil classification can be done according to Figure 3.

2.5.1 Slope

Excessive slope is an undesirable characteristics for wastewater irrigation. The main reasons are :

- a. Increase the flow velocity and may cause erosion.
- b. May lead to unstable soil conditions.
- c. May make crop growth difficult or impossible.

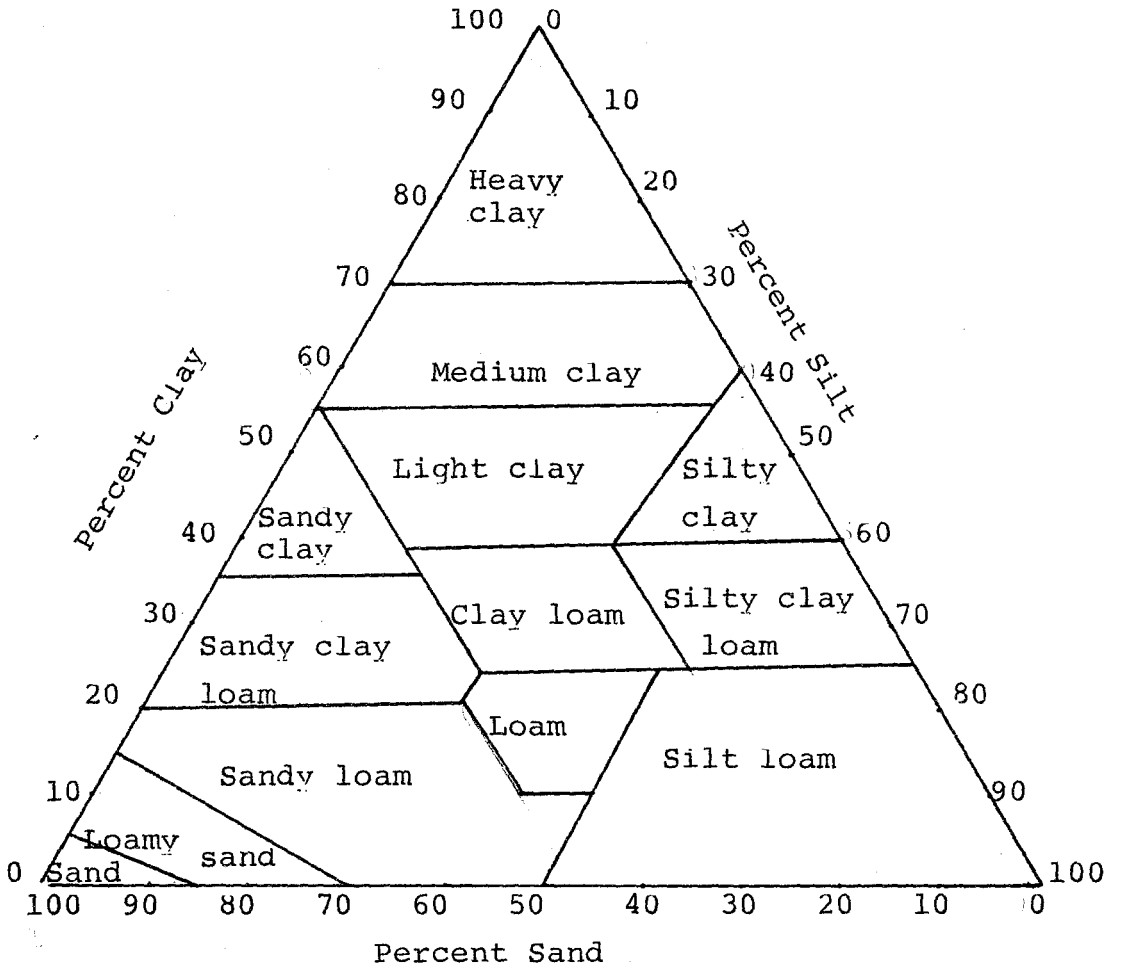

Figure 3 : Textural Classes (Crites,1984)

- d. Makes the irrigation cost very high.

Crites (1984) pointed out that a maximum slope of 15% is usually recommended for cultivated agriculture.

2.5.2 Soil Characteristics

The physical, hydraulic and chemical characteristics of the soil should be known before deciding to use an area for irrigation purposes.

Important physical characteristics are soil depth structure, texture. Important hydraulic characteristics include permeability or infiltration rate, while the most important chemical characteristics are pH, phosphorus, sodium, calcium, and other nutrients.

2.5.2.1 Physical Characteristics of Soil

i) *Depth*

The depth of soil is a very important parameter. It affects root growth and bacterial activities which have to take place, so that plant roots can extract water from depths varying from 0.3 to 2.7 m, although satisfactory results may be obtained sometimes outside of this range also. A depth less than 30 cm would limit cultivation, while from the point of pathogen removal, a depth of 1.5 m is desired (Arceivala, 1981).

ii) *Texture and Structure*

The size and type of particles that constitute a soil determine its structure. The classification of soil according to its size is as follows.

Clay	0.002 mm and smaller
Silt	0.002-0.05 mm
Sand	0.05-2.0 mm
Fine gravel	Larger than 2.0 mm

Grain size variation is one of the parameters which determines the structure of soil. Soils consisting of particles of uniform size are more porous while those in which size varies greatly are more dense.

2.5.2.2 Hydraulic Characteristics

An important design parameter of hydraulic characteristics are infiltration rate and saturated permeability. Infiltration rate is the rate by which water penetrates the soil surface when excess water is present.

A classification of soil according to its permeability prepared by Crites (1984) is given in Table 5.

TABLE 5 - Soil Permeability Classes (Crites, 1984)

Soil Permeability, cm/h	Class
< 0.15	Very slow
0.15 to 0.508	Slow
0.508 to 1.524	Moderately slow
1.524 to 5.08	Moderate
5.08 to 15.24	Moderately rapid
15.24 to 50.8	Rapid
> 50.8	Very rapid

2.5.2.3 Chemical Characteristics

The chemical properties of soil can affect the plant growth and permeability (EPA, 1977). These characteristics are pH, electrical conductivity (EC), sodium levels, etc.

Sanks and Asano (1976) stated that biological activity is reduced if pH drops below 5. Clay particles are dispersed in the soil if the soil has a high sodium level. The dispersed clay particles cause low permeability and poor soil aeration (Crites, 1984).

Soil permeability is another parameter affecting the yield of the soil. If the infiltration rate is low, it may be impossible to grow plants on that soil, because the necessary amount of water cannot be supplied. A permeability problem usually occurs in the upper few centimeters of the soil.

2.6 CROP SELECTION

The selection of crops generally depends on the agricultural practices, local climate, type of soil and quality of wastewater. Another aspect which should be considered is what percent of land is to be covered by what crop in each season. According to Arceivala (1976) the following crops can be grown on wastewater farms.

i) *Forage Crops (Crops used as feed for stock)*

Fodder grasses such as Bermuda grass, rye grass, tall wheat grass, Reed canary grass, alta fescue, para-grass, alfalfa.

ii) *Field Crops*

Corn, maize, wheat, barley, oats, rye, rice, pulses, millets, sugarcane, sugar beets, cotton, flax, essential oil-bearing plants, tobacco.

iii) *Vegetables*

Tomato, potato, lettuce, red beet, artichokes, broccoli, spinach, soybeans, beans, cabbage, okra, clover.

iv) *Fruits*

Citrus, fruits, stone fruits, berries, strawberries, grapes, bananas.

v) *Others*

Various trees, woodlands, ornamental plants, flowers.

2.7 NUTRIENT REMOVAL

Removal of nutrients present in wastewater is one of the main requirements of wastewater treatment. The mechanism of nitrogen and phosphorus removal in wastewater treatment is given below.

2.7.1 Nitrogen Removal

Wastewater contains four forms of nitrogen: Organic, ammonium, nitrate and low concentrations of nitrite. Some ammonia may be volatilized from wastewater at pH values between 7.5 to 8.0. Ammonium ions can be absorbed by the clay and organic colloids in soil. Nitrite nitrog

is easily oxidized to nitrate in the presence of oxygen. Nitrogen in the nitrate form moves with the water through the root zone. The ammonia and organic forms of nitrogen are retained in the soil by adsorption or removed by crop uptake. Nitrate-nitrogen can be removed only by growing crop or by denitrification. Nitrogen removal by crops is dependent on the length of growing season, crop type and nitrogen availability.

A forage crop can remove 168-672 kg/ha or more, field crops can remove 84-168 kg/ha and forest can remove 22-112 kg/ha of nitrogen. Culp (1978) reported that removal efficiencies of Reed Canary Grass varies from 68 to 84 percent. The nitrogen removal efficiency of crops vary widely and the total amount removed depends on both the crops species and nitrogen loading.

High levels of nitrogen can interfere with productivity of crops. There is little hazard of nitrogen toxicity to crops where typical municipal effluent is applied to land.

The organic nitrogen and ammonia-nitrogen are stored in the soil during winter. When the weather warms, nitrification occurs over a short period of time, and concentrations may reach high levels with excess nitrogen available, some crops can accumulate high levels of nitrate which may be toxic to humans (Arceivala, 1981).

2.7.2 Phosphorus Removal

Phosphorus is removed by adsorption on the cation-exchange complex, by precipitation and by sorption with iron and aluminum oxides. The removal of phosphorus is dependent on the soil texture, the cation exchange

capacity and the uptake of phosphorus by the crop. For coarse textured soils with little calcium, iron, or aluminum, the removal capacity may be limited.

Phosphorus accumulating in soil over a long period of time may interfere with crop growth. This interference occurs as a nutrient imbalance in the plant, and high phosphorus levels in the soil may reduce the availability of some crop micronutrients. Thus the plant may develop low levels of other required nutrients rather than toxic levels of phosphorus (Arceivala, 1981). Precipitation of the phosphorus would be expected to minimize any toxicity problems.

From among the nutrients in wastewater applied on land, phosphorus and potassium are removed while passing through the soil, but nitrogen is not. Table 6 shows the uptake of nutrients by some crops.

TABLE 6 - Crop Uptake of Nutrients (Arceivala, 1981)

C R O P	Uptake (kg/ha-year)	
	Nitrogen as N	Phosphorus as P
Bermuda Grass	538-672	39
Reed Canary Grass	253	40
Alfalfa	174-246	18-24
Corn	174	28
Soy beans	111-127	16-20
Wheat	69-85	13-16

III. EXPERIMENTAL SET-UP, PROCEDURE AND RESULTS

As mentioned earlier the study can be separated into two main parts.

- a) Land disposal of wastewater
- b) Crop productivity.

3.1 THE LAND DISPOSAL STUDY

The experimental set-up procedure and results obtained are given below.

3.1.1 Experimental Set-up

To investigate the effects of soil disposal of wastewater, the experimental set-up constructed earlier by Baysal in the garden of Boğaziçi University.

The system consists of the inlet tank, the channels and the outlet tank. Details for each part are given below and in Figures 4 and 5.

a) *The Inlet Channel*

The first tank was constructed and modified according to the purposes of this study over an already existing sewage outlet, above the

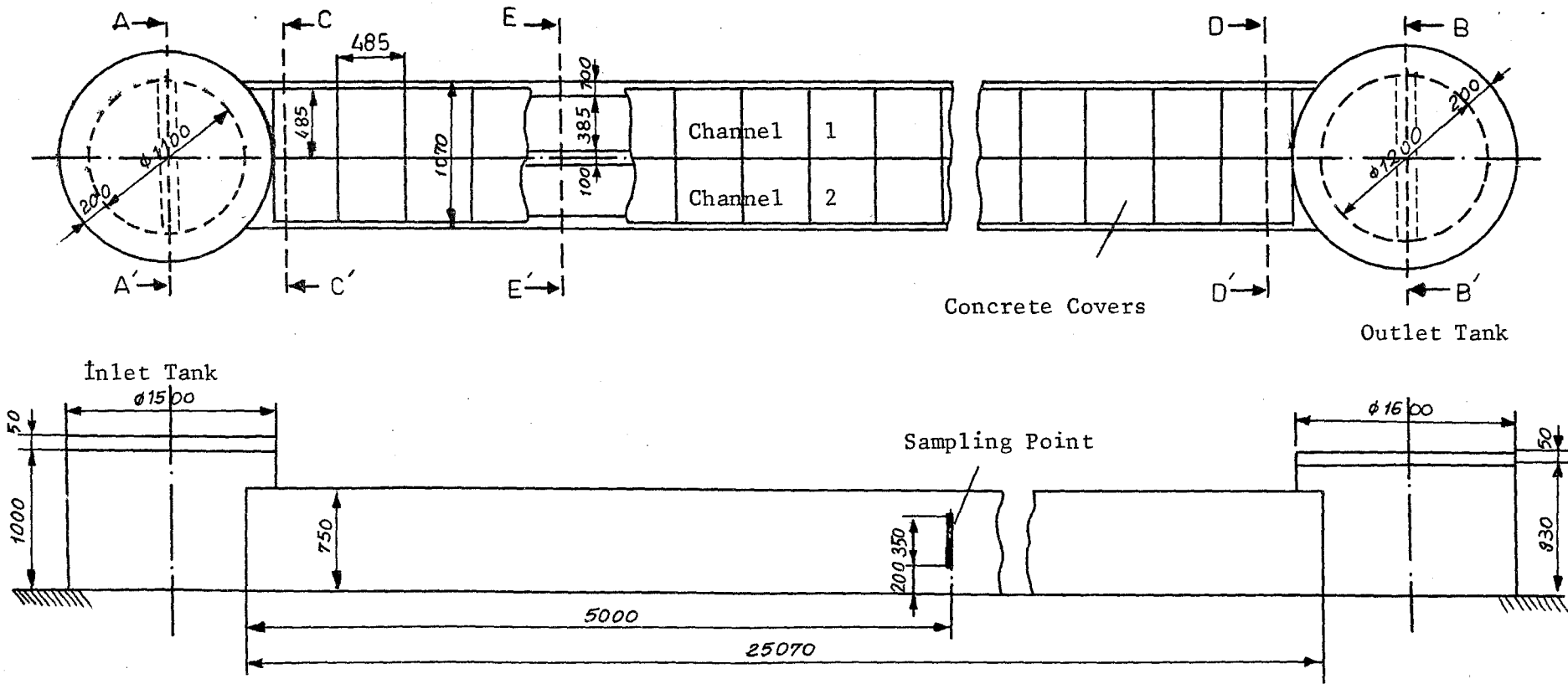

Figure 4a : Top View of the System
 b : Side View of the System
 (A.Baysal,1984)

main University sewage line. In front of the outlet a concrete barrier was constructed to change the direction of the main wastewater stream and ensure its flow through the constructed channels. Details of inlet tank are given in Figures 6 and 7.

The wastewater enters from the tank to the channels through two 140 mm holes located 30 cm below the surface of the tank. Special iron gates located in front of these holes in order to adjust the flowrate of the wastewater entering to the two channels (Figures 8 and 9).

The top of the tank is covered with specially designed concrete covers to prevent the leakage of rain as well as to eliminate to odour problem.

b) *The Channels*

Two concrete channels were connecting the entrance outlet tanks. These channels are parallel to each other and have a length of 25 meters.

The interior of each channel has three different compartments. These are two chambers and an internal channel and has a length of 2.5 m to prevent turbulence and drag forces. At this part some suspended particles coming from the first tank are allowed to settle. At the end of this chamber, six perforated bricks ensure the uniform entrance of the wastewater into the internal channel containing the porous media. The channel between these two chambers has a length of 21 meters, a height of 0.35 meters and a width of 0.285 meters (Figure 10). Both channels have square concrete covers to prevent the leakage of rain, odour and other disturbances during the study.

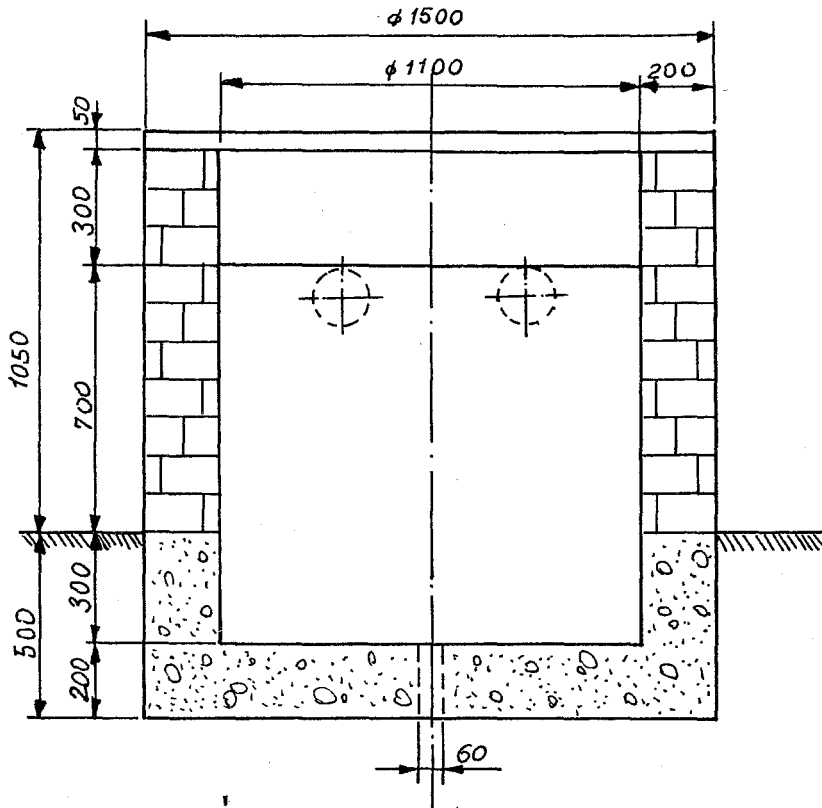

Section A-A

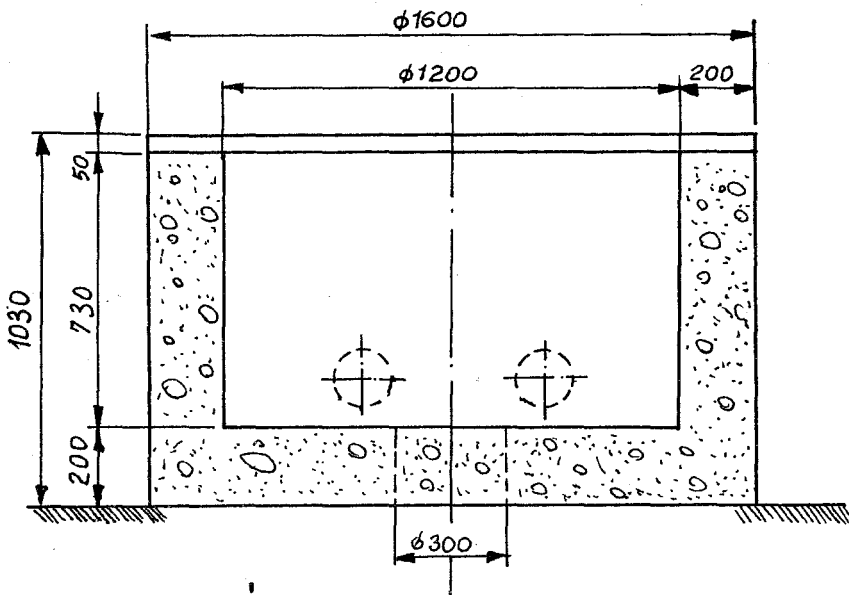

Section B-B

Figure 6a: Cross-Sectional View of the Inlet Tank
 b: Cross-Sectional View of the Outlet Tank
 (A.Baysal, 1984)



Figure 5 : The View of the Channels and the Outlet Tank



Figure 7 : Photograph of the Inlet Tank "L" Type Covering Plate and Overflow pipe



Figure 8: Photograph of the Inlets

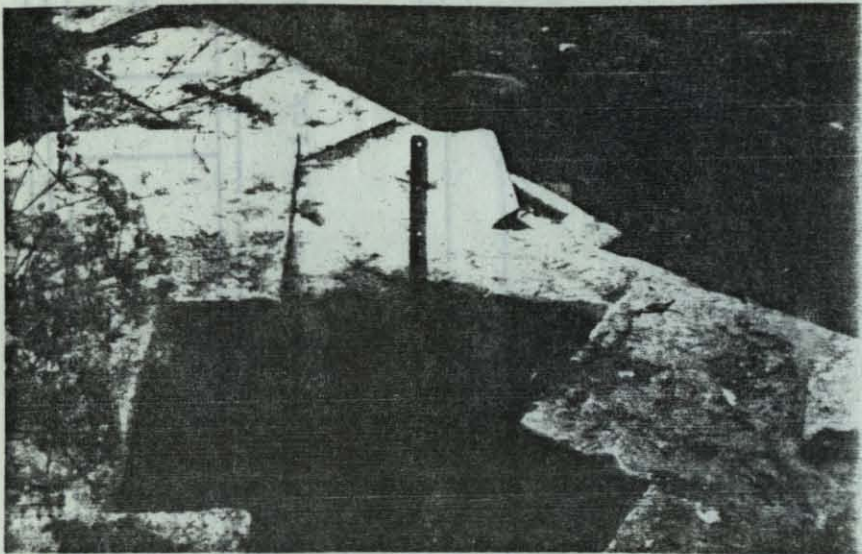

Figure 9 : Photograph of the Iron Plate



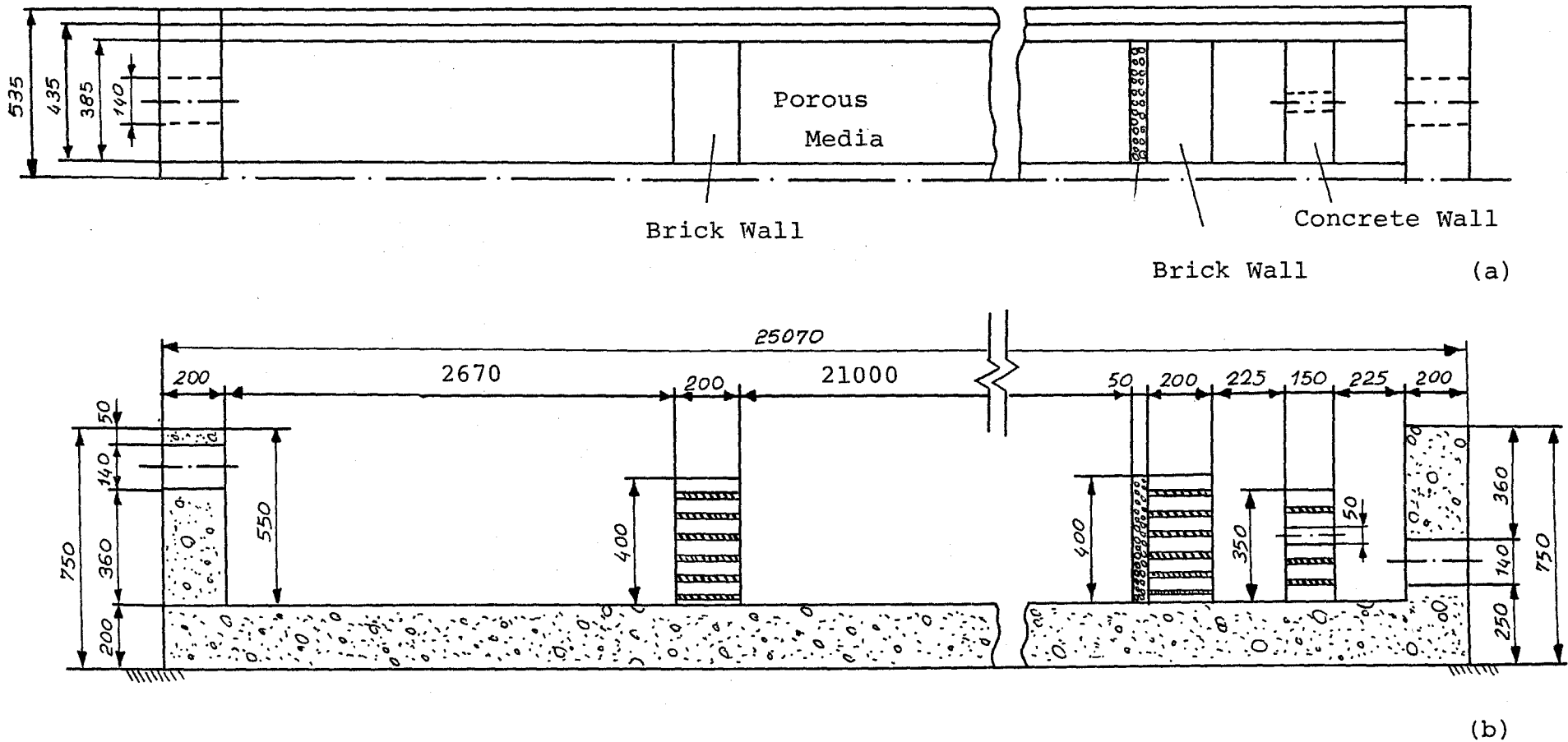

Figure 10a : Top View of the Channel
 b : Longitudinal Cross- Section of the Channel
 (A.Baysal, 1984)

Each channel has 4 outlets on each side constructed of 0.85 m plastic pipes at intervals of about 5 meters. The outlets are sealed with plastic stoppers, easily removable for sampling purposes.

At the end of each channel there are six brick walls to prevent sand particles from reaching the final chamber. Between the brick walls and final chamber, there is a small concrete wall in each channel. This concrete wall has a hole at the bottom in which treated water passes to the other side as soon as the water level reaches 0.18 meter height (Figure 11).

c) *The Final Tank*

The height of this tank is 0.93 meters. The outer diameter is 1.60 meters, where as the inner diameter is 1.20 meters. The cross-sectional view of the tank is shown in Figure 12. The inner side is divided into two sections by a concrete block to avoid clogging of the piping system leading to the main sewer line with sand particles that may escape through the perforated wall (Baysal, 1984).



Figure 11 : Photograph of the Concrete Wall at the end of the Channel



Figure 12 : Photograph of the Outlet Tank (Final Tank)



Figure 13 : Photograph of Cleaning of the Channels

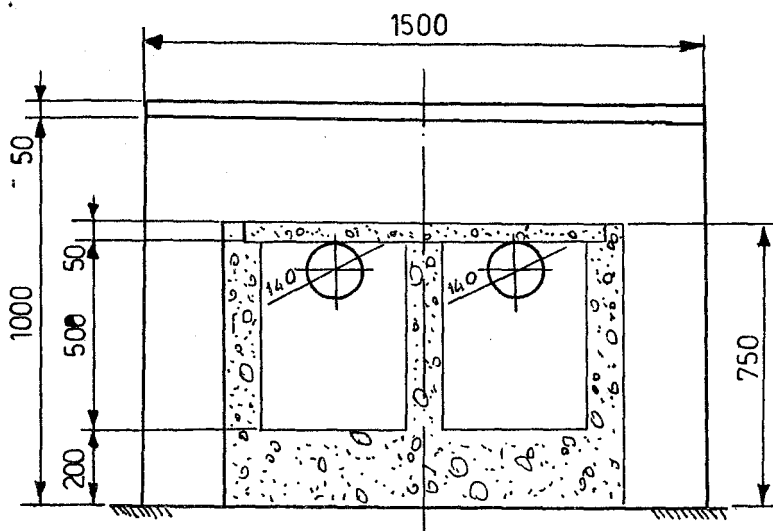

Section C-C'

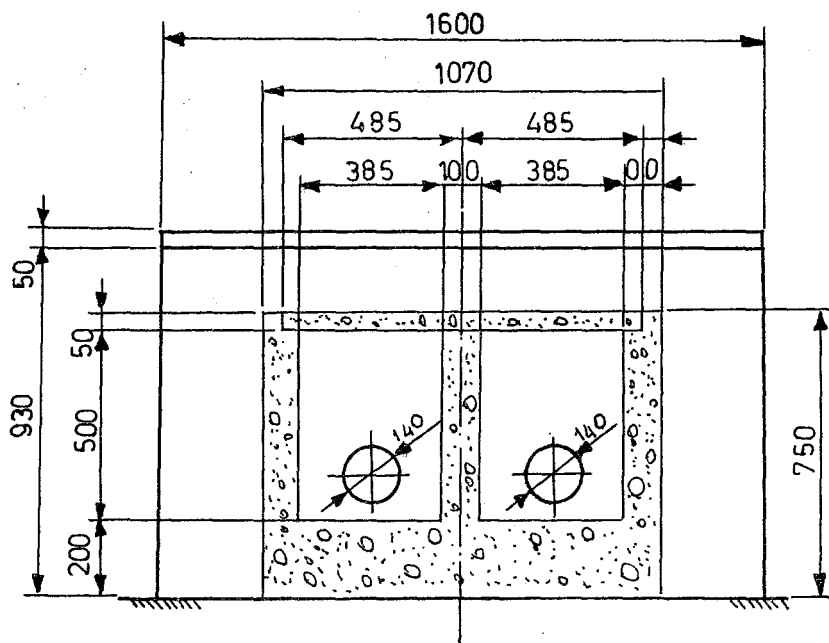

Section D-D'

Figure 13a: The Inlet Cross-sectional View of the Channel
 b: The Outlet Cross-sectional View of the Channel
 (A.Baysal, 1984)

3.1.2 Experimental Procedure

The experimental procedure followed during the study related to the land disposal part can be summarized as follows.

1. The sand and gravel were sieved and placed into the channels.
2. The porous media located into the channels was washed throughly to remove any existing impurity (Figure 13).
3. Samples of porous media are collected and sieve analysis another experiments were performed.
4. Wastewater was applied on both channels.
5. After the flow was adjusted samples were collected periodically (twice a week) from the inlet, the intermediate sampling point and the outlet and the required experiments were performed.

3.1.2.1 The Porous Media

Two materials were used as filter media sand and gravel. Sand was river-sand while the gravel was broken stone. The granulometric curves of the sand and gravel are given in Figure 14 and in Figure 15. The effective size of sand as can be seen in these figures is 3.25 mm and of gravel is 1.0 cm. Figures 16 and 17 show the top view as sand and gravel after being located in the channels.

- i) The total volume of the sand distributed in the channel is; 2.83 m^3 having a depth 0.35 m and length 21 m.

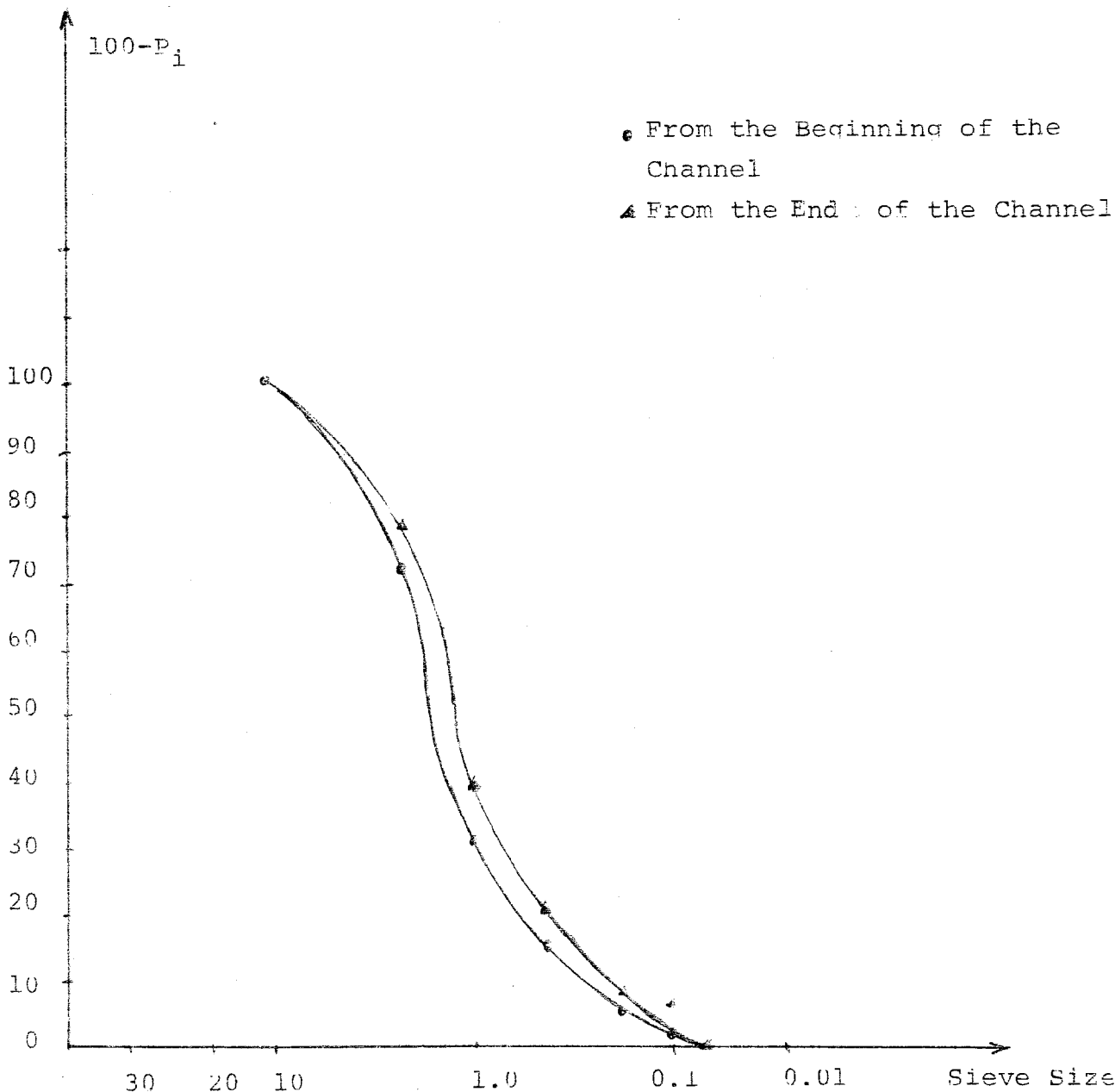

Figure 14 : The Granulometric Curves of Sand Samples

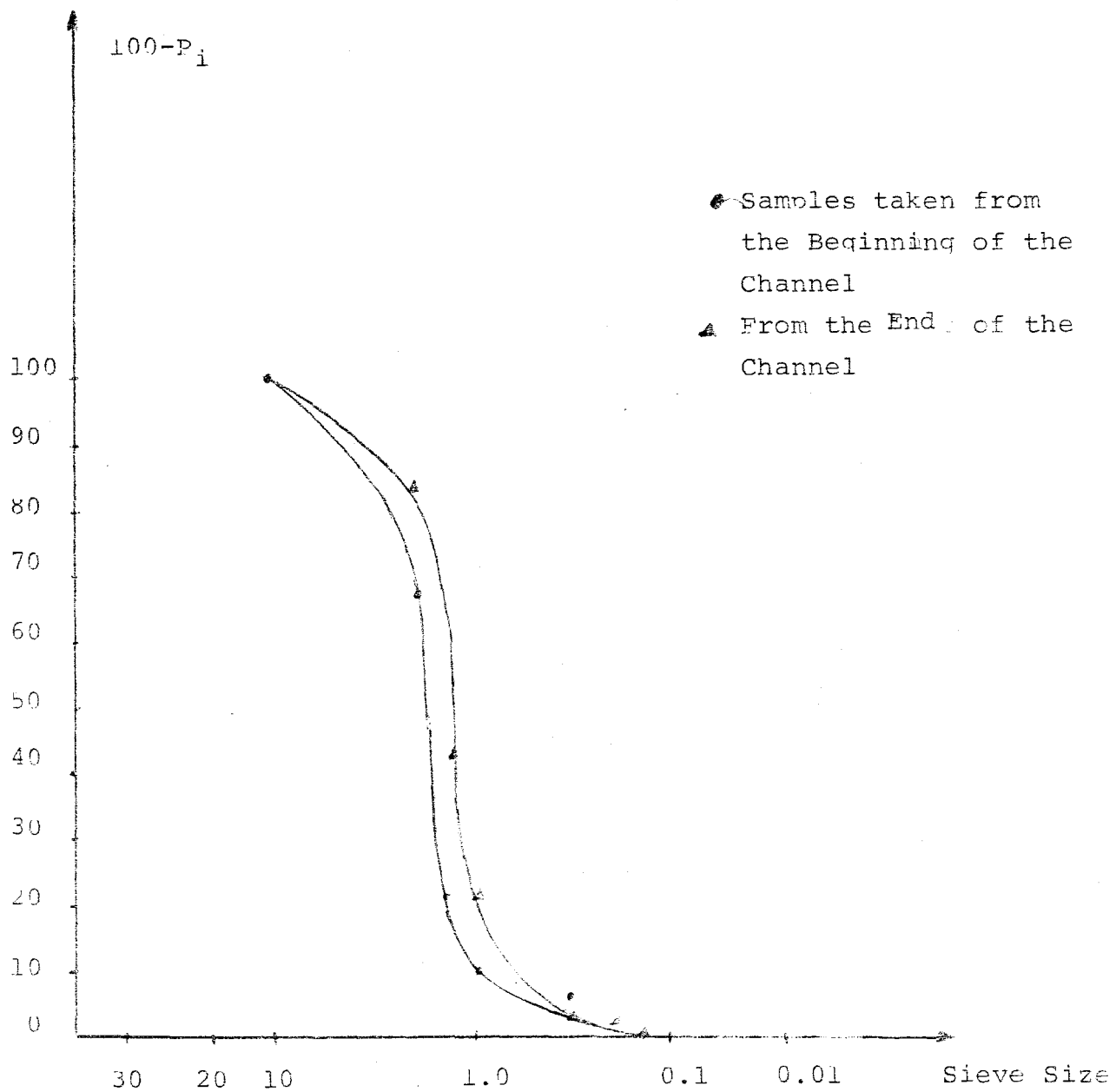

Figure 15 : The Granulometric Curves of Gravel Sample

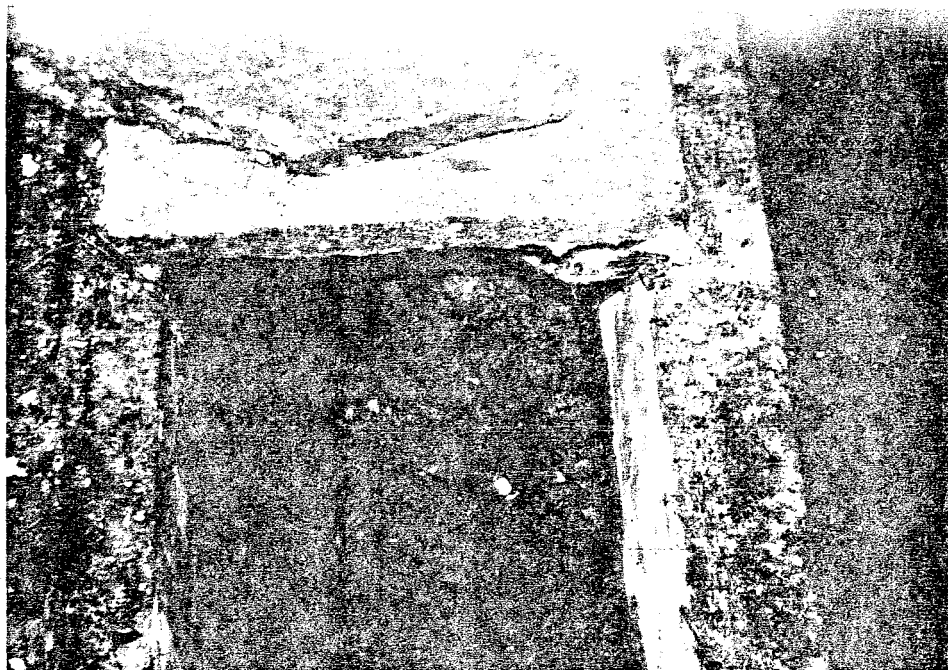

Figure 16 : The Channel Full with Sand

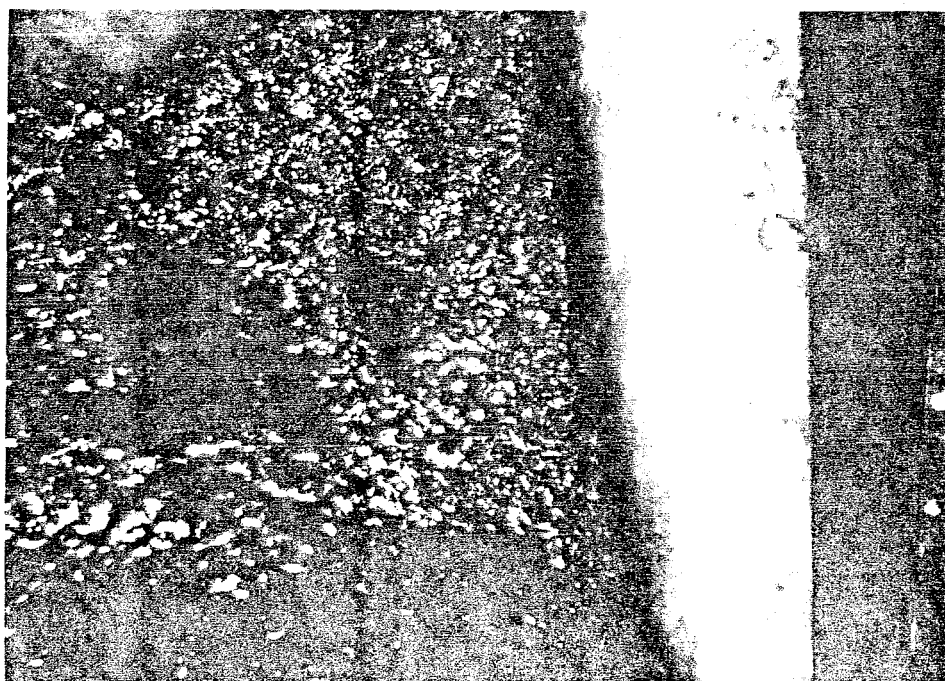

Figure 17 : The Channel Full with Gravel

- ii) The porosity of sand is 40% ...

On the other hand

- iii) the total volume of the gravel distributed in the channel is 3.234 m^3 having a depth 0.40 m and length 21 m.
- iv) The porosity of gravel is 43%.

3.1.2.2 The Wastewater

The wastewater from the sewer of Boğaziçi University was used during this study. The characteristics of this wastewater can be summarized as follows.

The purpose of these experiments was to determine the variation of wastewater characteristics with time and distance related to filter material size. The parameters determined during this study are pH, nitrogen, phosphorus, solids, COD (Chemical Oxygen Demand) and total coliform. For the determination of nitrogen Kjeldahl nitrogen, for coliform, the Membrane Filter Method and for phosphorus the Stannous Chloride Method were applied.

In the tests the methods given in the 15th edition of the Standard Methods for the examination of water and wastewater (1981) have been used.

3.1.3 Experimental Results

Wastewater samples were collected from different points of each channel at different time intervals and the chemical oxygen demand, nitrogen, phosphorus, pH, coliform, solids and turbidity values were determined.

The results obtained are given in a tabular form in Appendix B. Evaluation of variation of each parameter is given in the parts which follow:

3.1.3.1 Chemical Oxygen Demand (COD)

The variation of COD values with time in the channel which was filled with sand is given in Figures 18. 19 and 20 show the variation of the removal efficiency of COD with distance and time. The variation of COD values with distance is given in Figure 21. Carefully examination of these figures lead to the following conclusions:

- i) The overall COD removal achieved is about 76%. Taking into consideration that the removal efficiency of activated sludge process ranges between 65% and 90% and of trickling filter is about 65-85% (Fair, Geyer and Okun, 1968). This is considered as a satisfactory result.
- ii) The percent removal of COD is increasing constantly with distance while it does not show any considerable change with time.
- iii) The amount of COD decreases with distance influent values vary between 470-590 mg/L. At 25 meters the amounts of COD range between 135-240 mg/L.

For the case where gravel was used as porous media, the variation of COD values with time is given in Figures 22 and 23 shows the removal efficiency of COD with time.

The removal efficiency of COD with distance is also shown in Figure 24. The variation of COD values with distance is given in Figure 25.

Examination of these figures leads to the following conclusions:

- i) The COD removal efficiency is constant with distance.

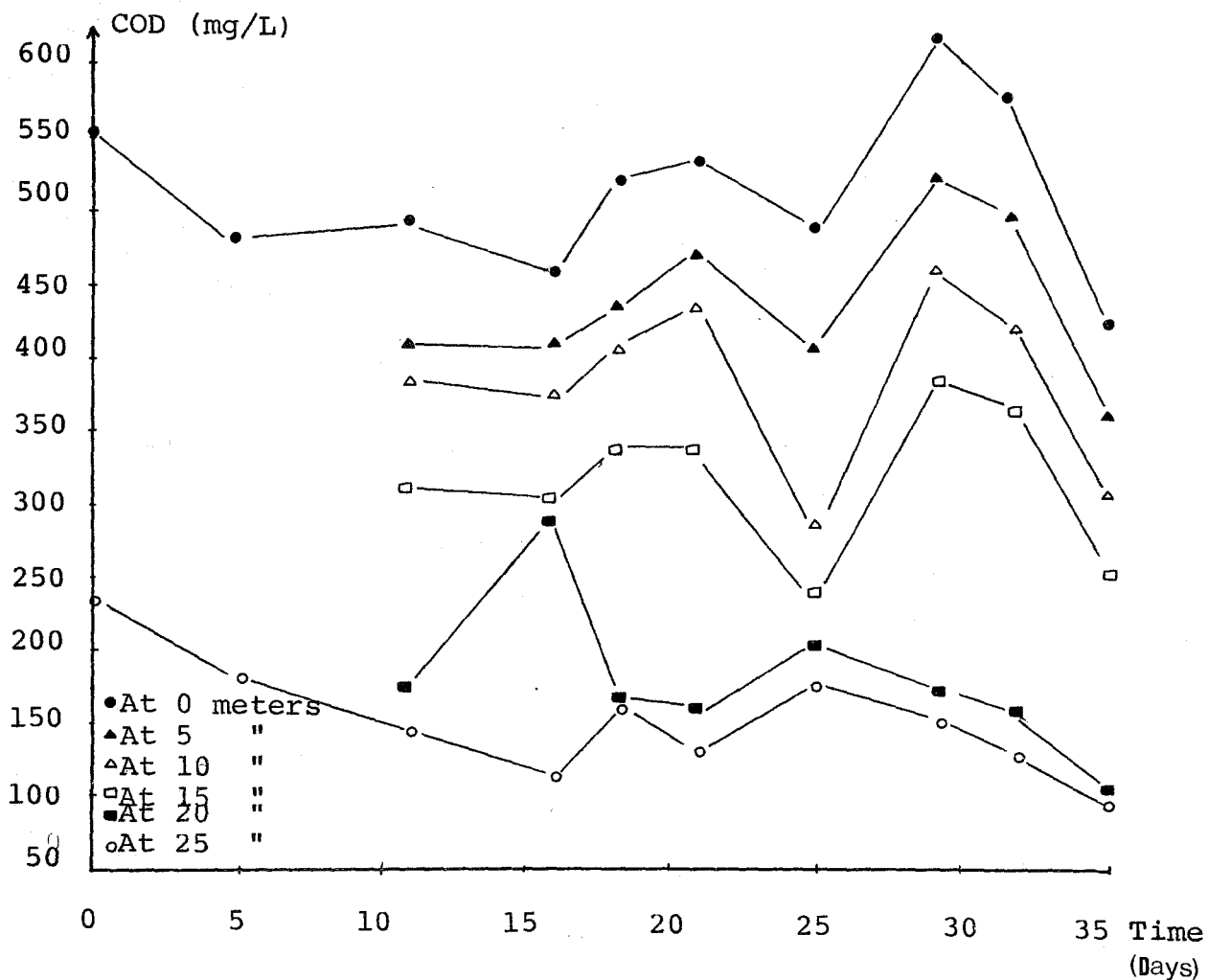

Figure 18 : Graphical Presentation Showing the Variation of COD with Time in the Channel Full with Sand

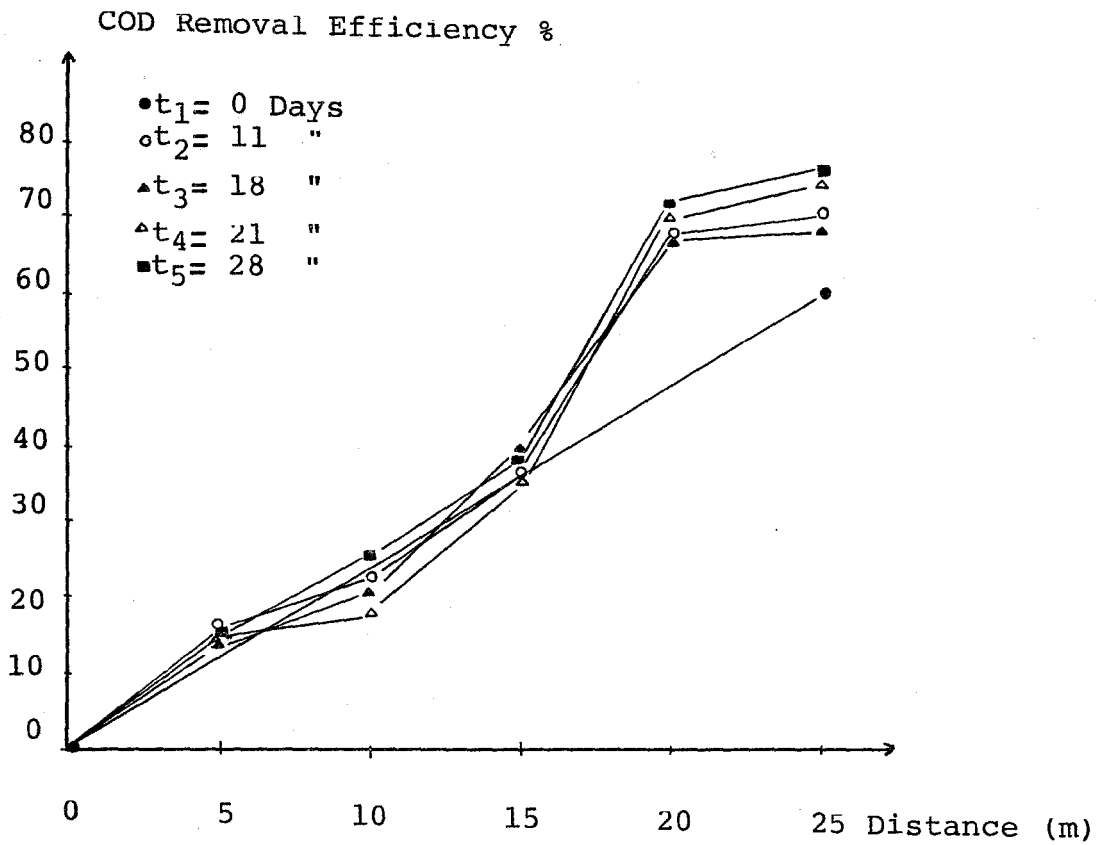

Figure 19 : The Removal Efficiency of COD with Distance in the Channel Full with Sand

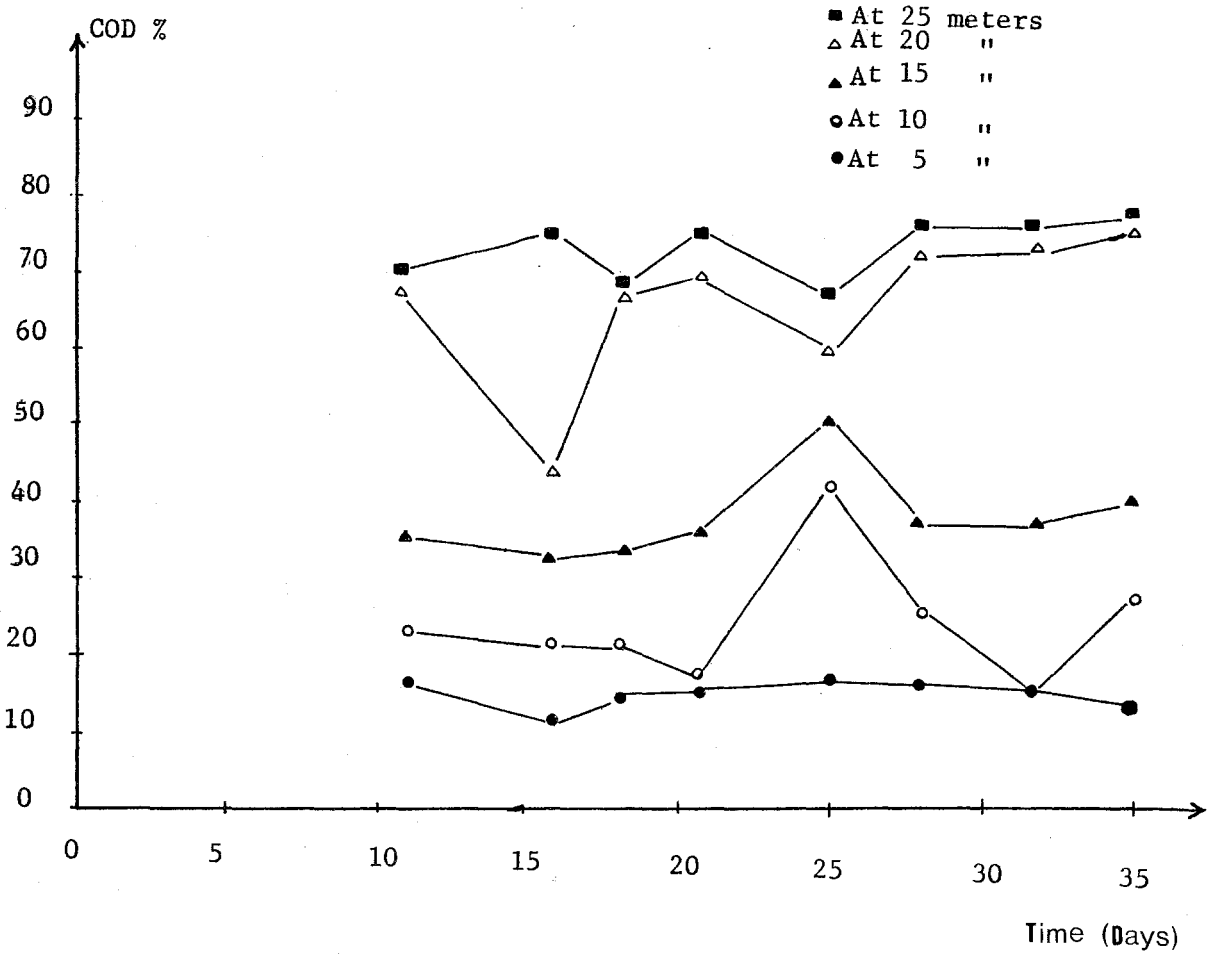

Figure 20 : Graphical Presentation Showing the Removal Efficiency of COD with Time in the Channel Full with Sand

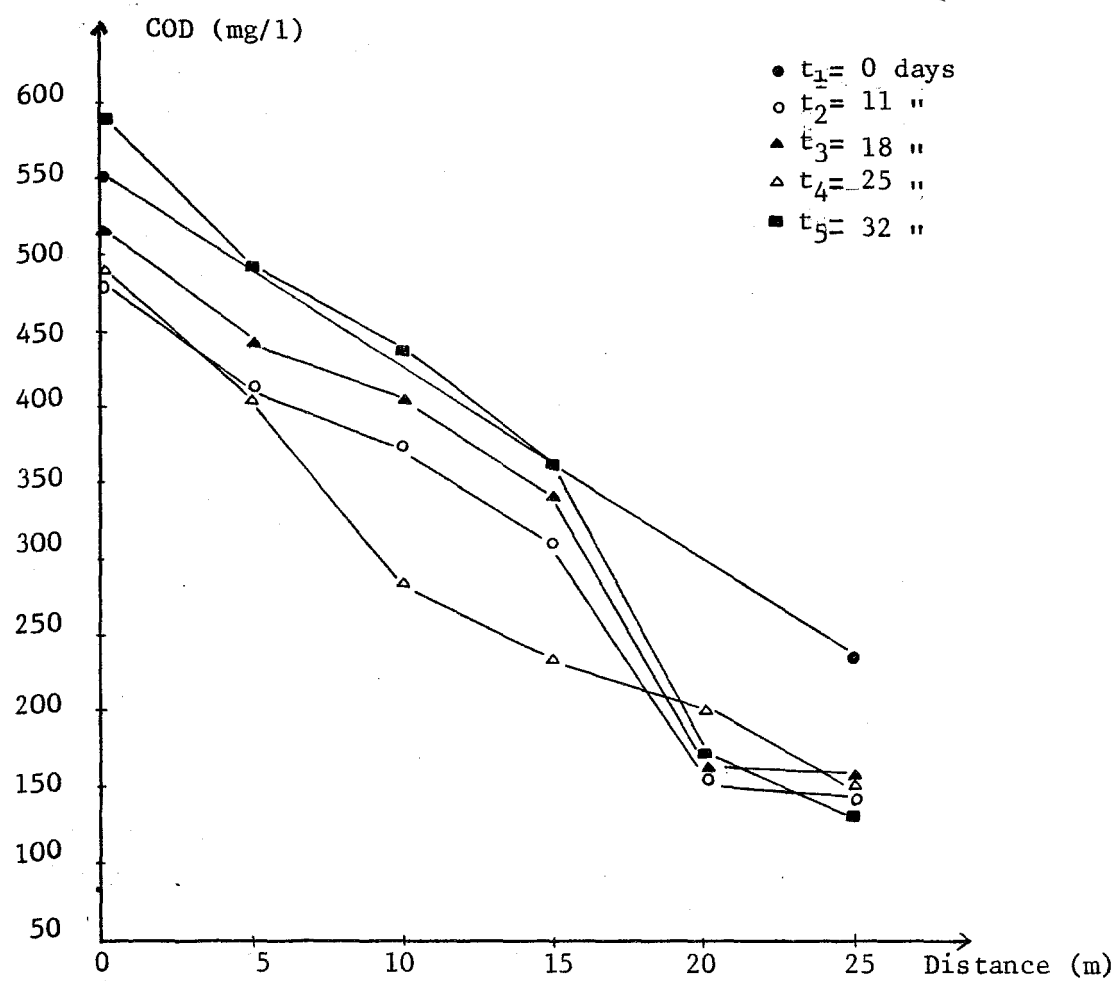

Figure 21 : Graphical Presentation Showing the Variation of COD with Distance in the Channel Full with Sand

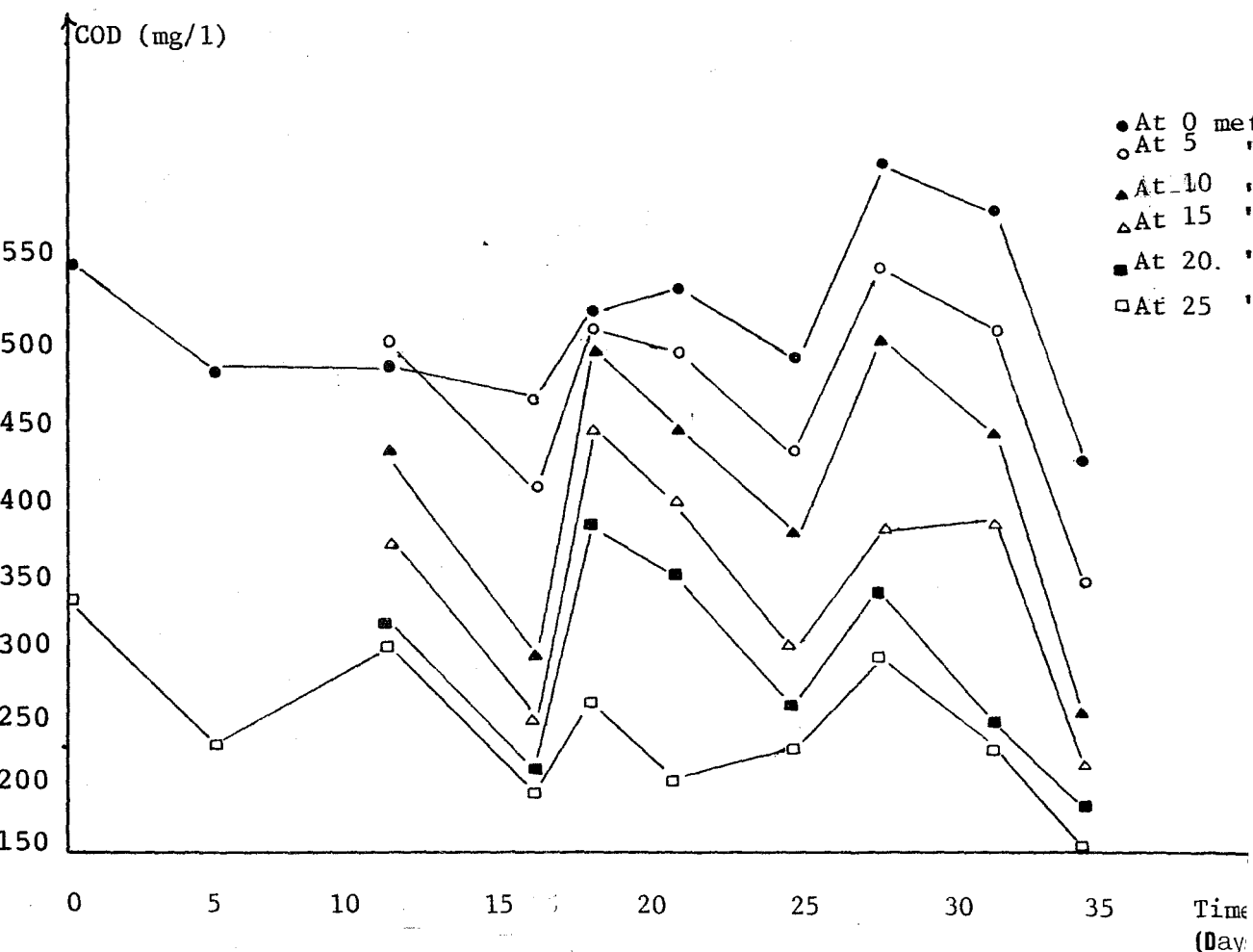

Figure 22 : Graphical Presentation Showing the Variation of COD w Time in the Channel Full with Gravel

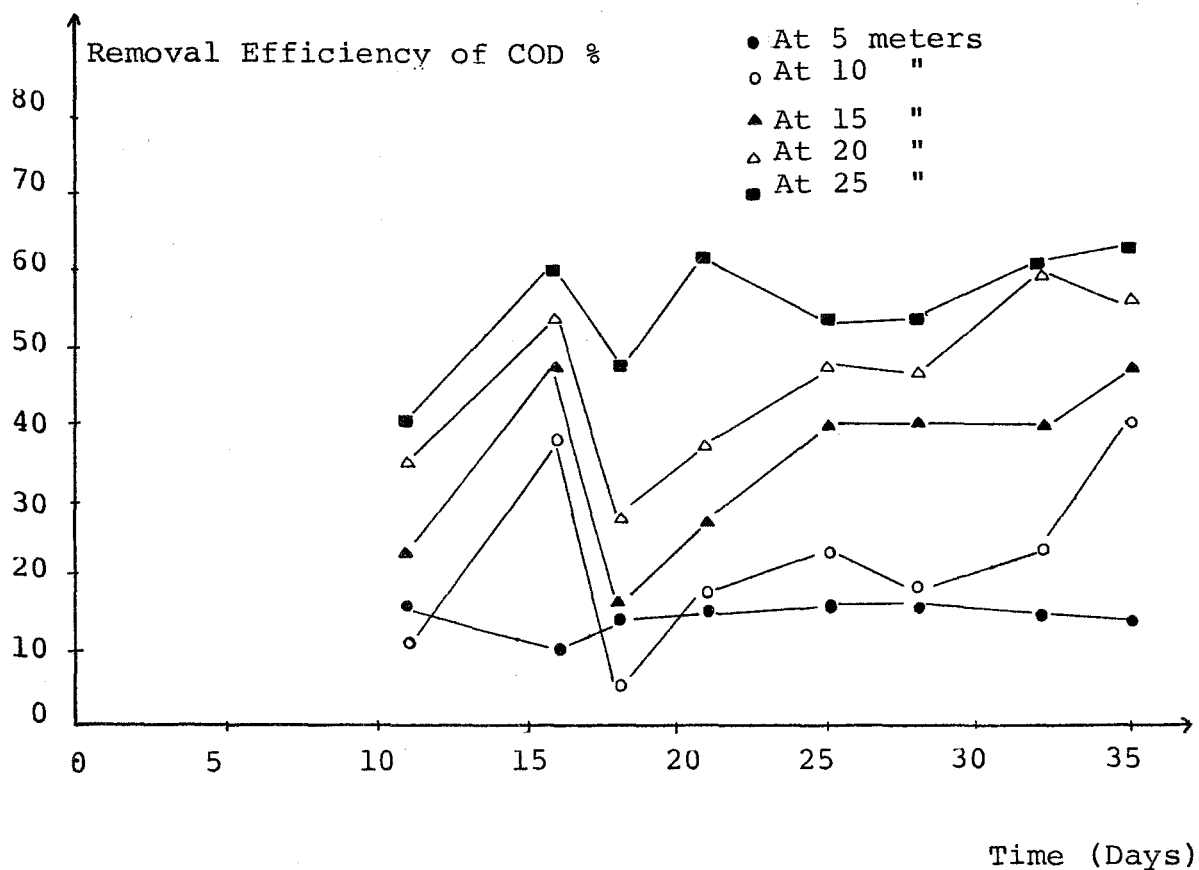

Figure 23 : Graphical Presentation Showing the Removal Efficiency of COD with Time in the Channel Full with Gravel

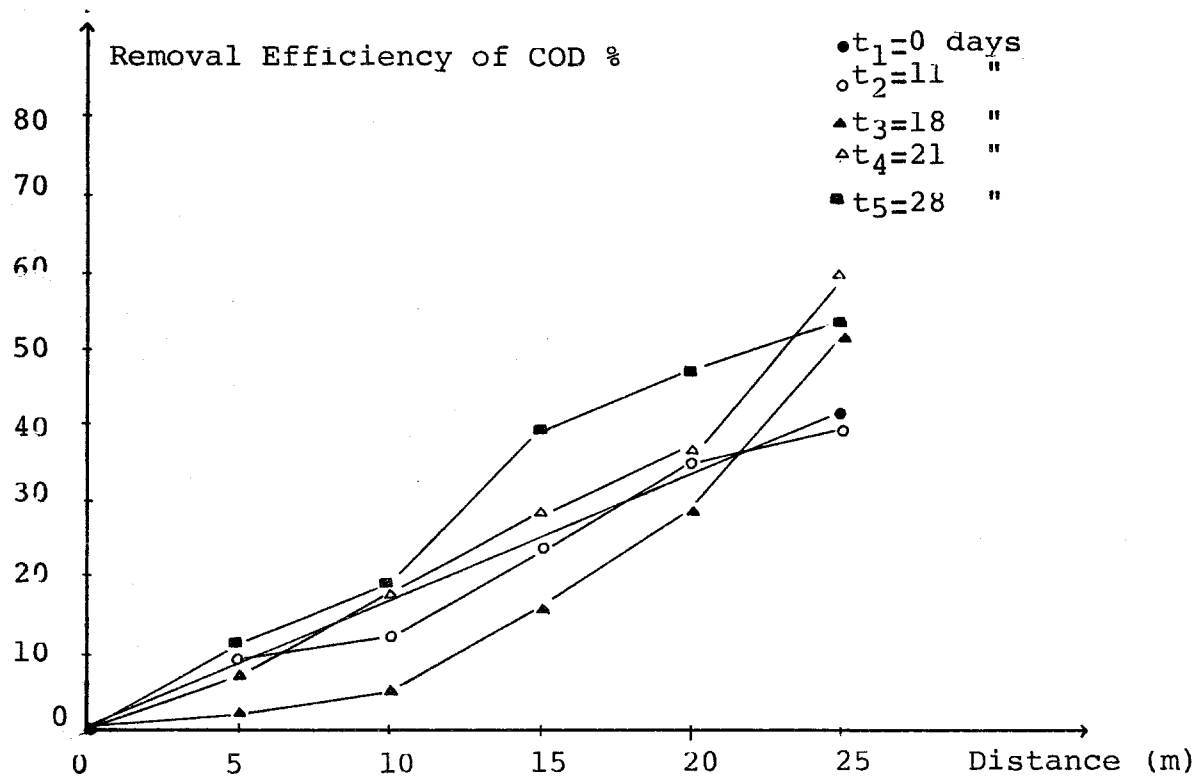

Figure 24 : Graphical Presentation Showing the Removal Efficiency of COD with Distance in the Channel Full with Gravel

- ii) The overall percent removal efficiency achieved is around 60%.
- iii) COD values decrease with distance.

Combining the results obtained by the present study with the results of Baysal (1984), showing the variation of COD removal efficiency with effective size of porous media has been prepared (Figure 26).

Sand of 0.55 mm and 3 mm effective size has yielded almost the same result but the COD removal efficiency is reduced with 10 mm (1 cm) effective size.

3.1.3.2 Nitrogen (N)

The variation of nitrogen concentration was one of the parameters determined in this study. The results expressed as Kjeldahl nitrogen are given in the following figures. Figures 27, 28, 29 and 30 are related to sand, Figures 31, 32, 33 and 34 are related to gravel. As can be seen in these figures, the following results are obtained.

- i) The overall percent N removal achieved is about 70% in sand and about 57% in gravel.

According to Sanks and Asano (1976), the removal efficiency of over land runoff is about 60-90% and of rapid infiltration is about 70-90%.

- ii) The amount of nitrogen decreases with distance.
- iii) The nitrogen removal efficiency increases with distance.

Figure 35 shows that the removal efficiency of nitrogen is reduced with increasing effective size.

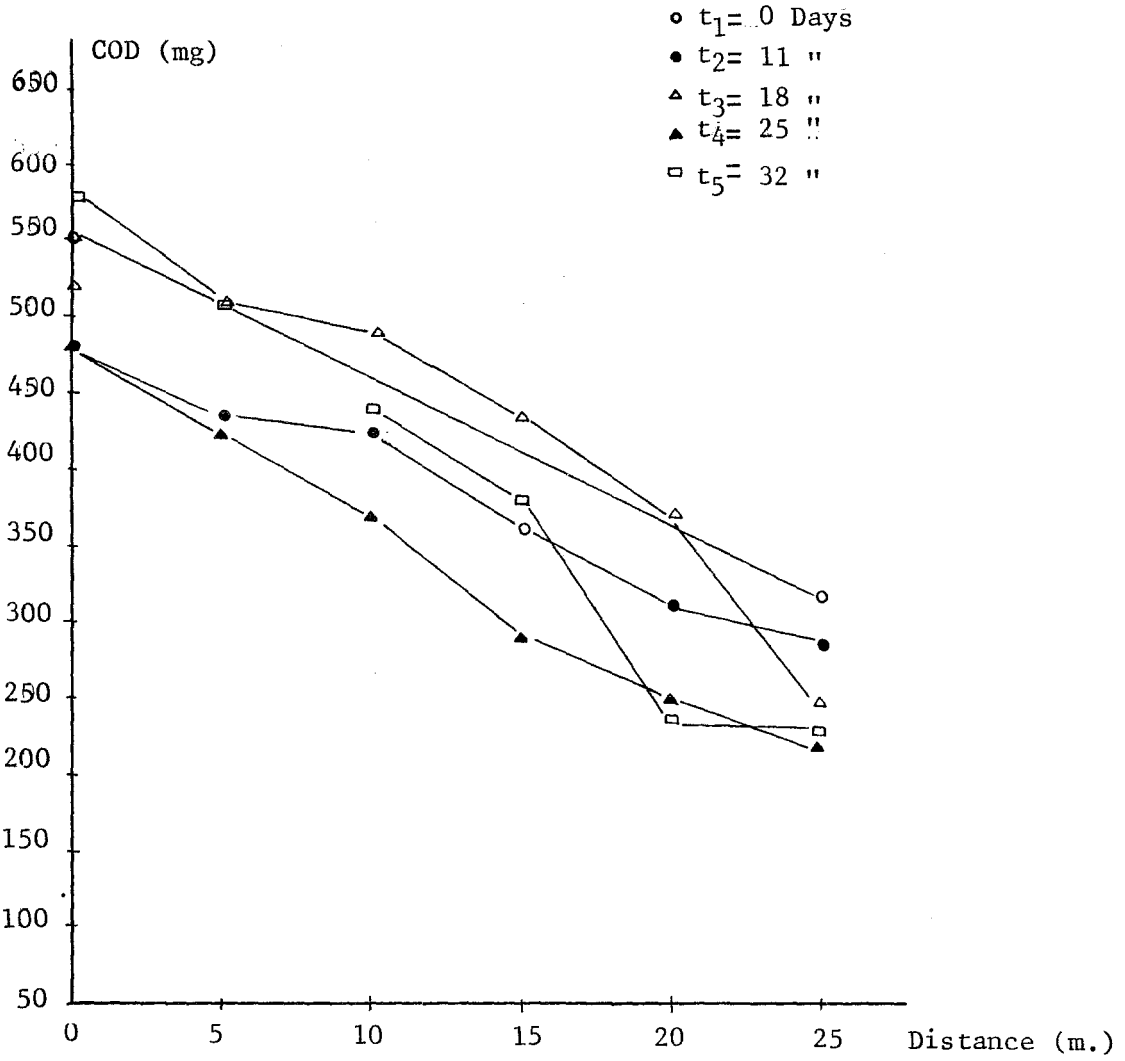

Figure 25 : Graphical presentation Showing the Variation of COD with Distance in the Channel Full with Gravel

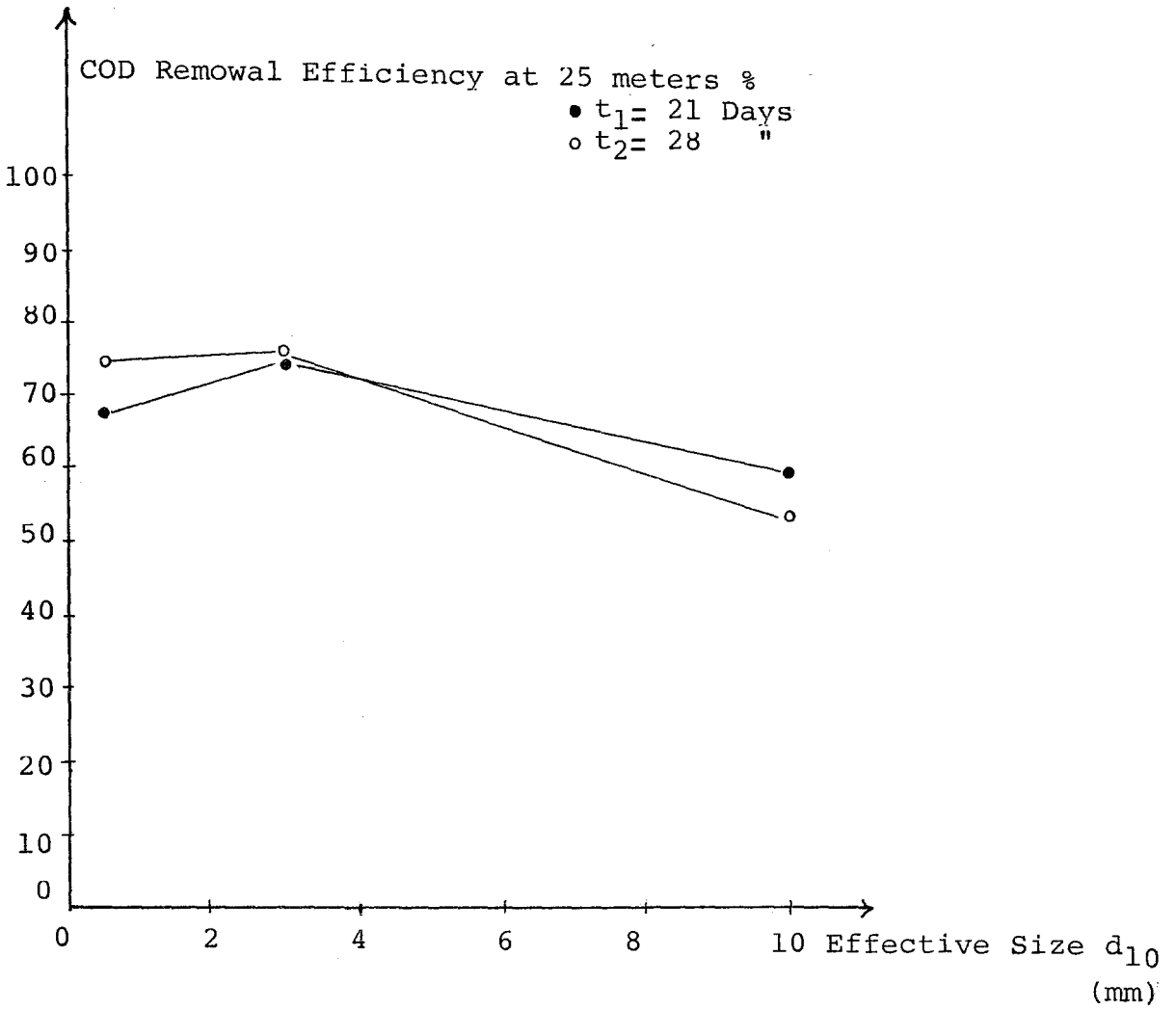

Figure 26 : Graphical Presentation Showing Variations of COD Removal Efficiency with Effective Size of Porous Media (at 25 meters)

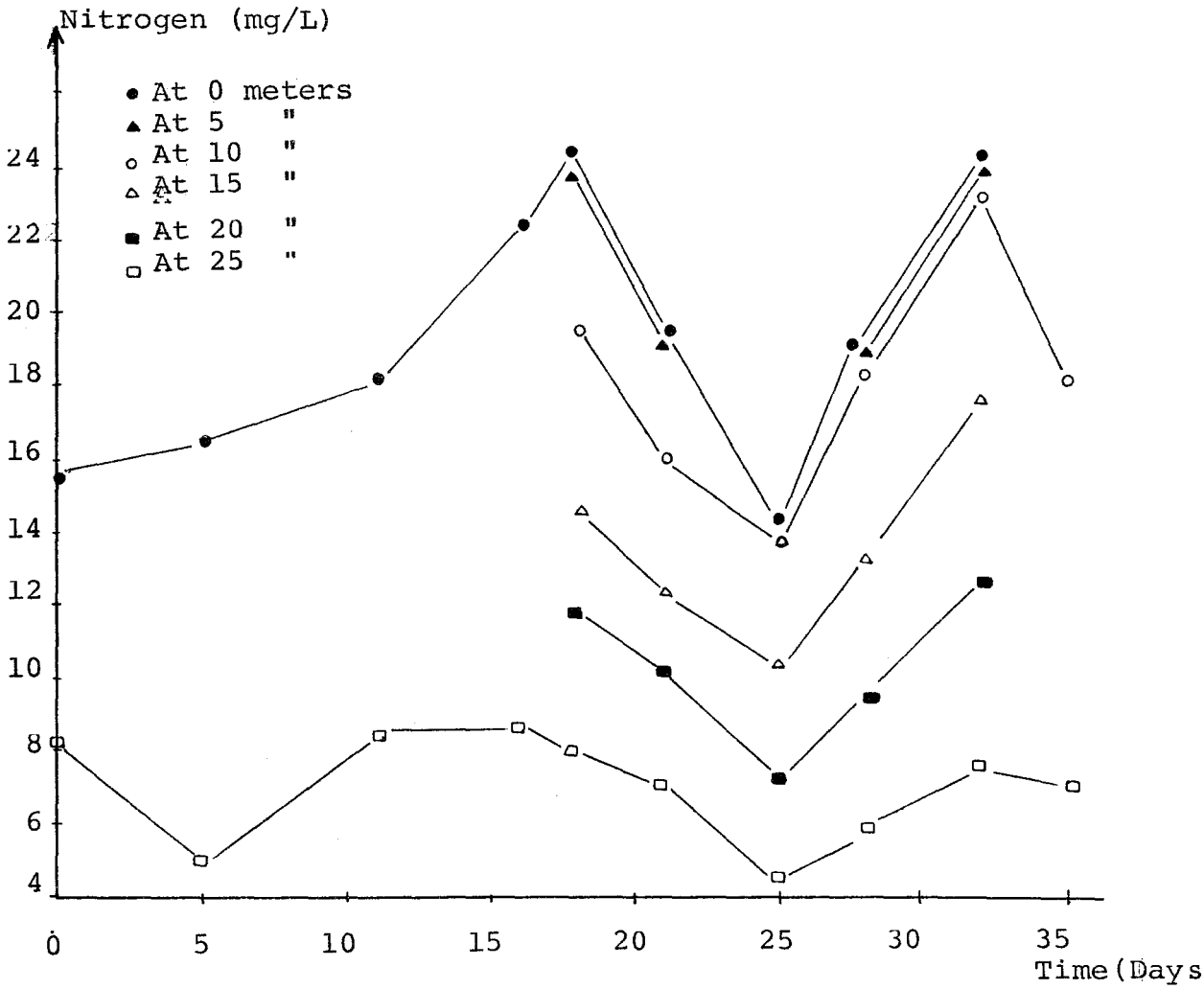

Figure 27 : Graphical Presentation Showing the Variation of Nitrogen with Time in the Channels Full with Sand

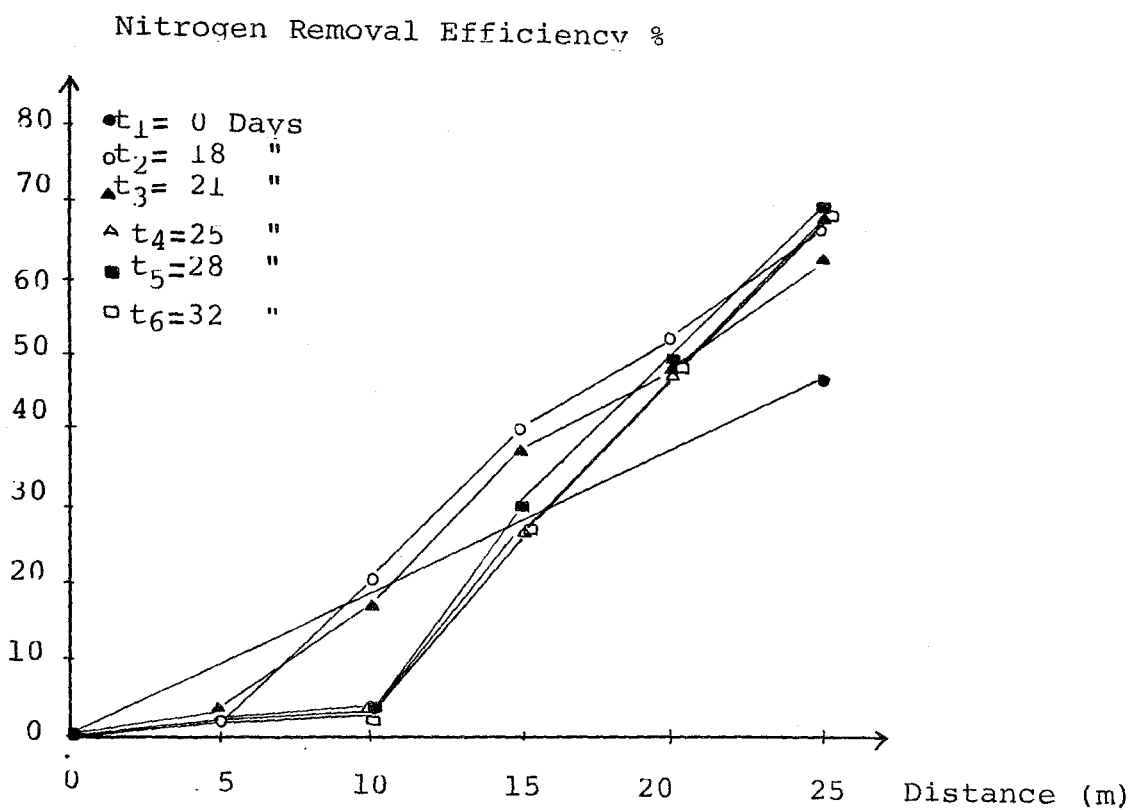

Figure 28 : The Removal Efficiency of Nitrogen with Distance in the Channel Full with Sand

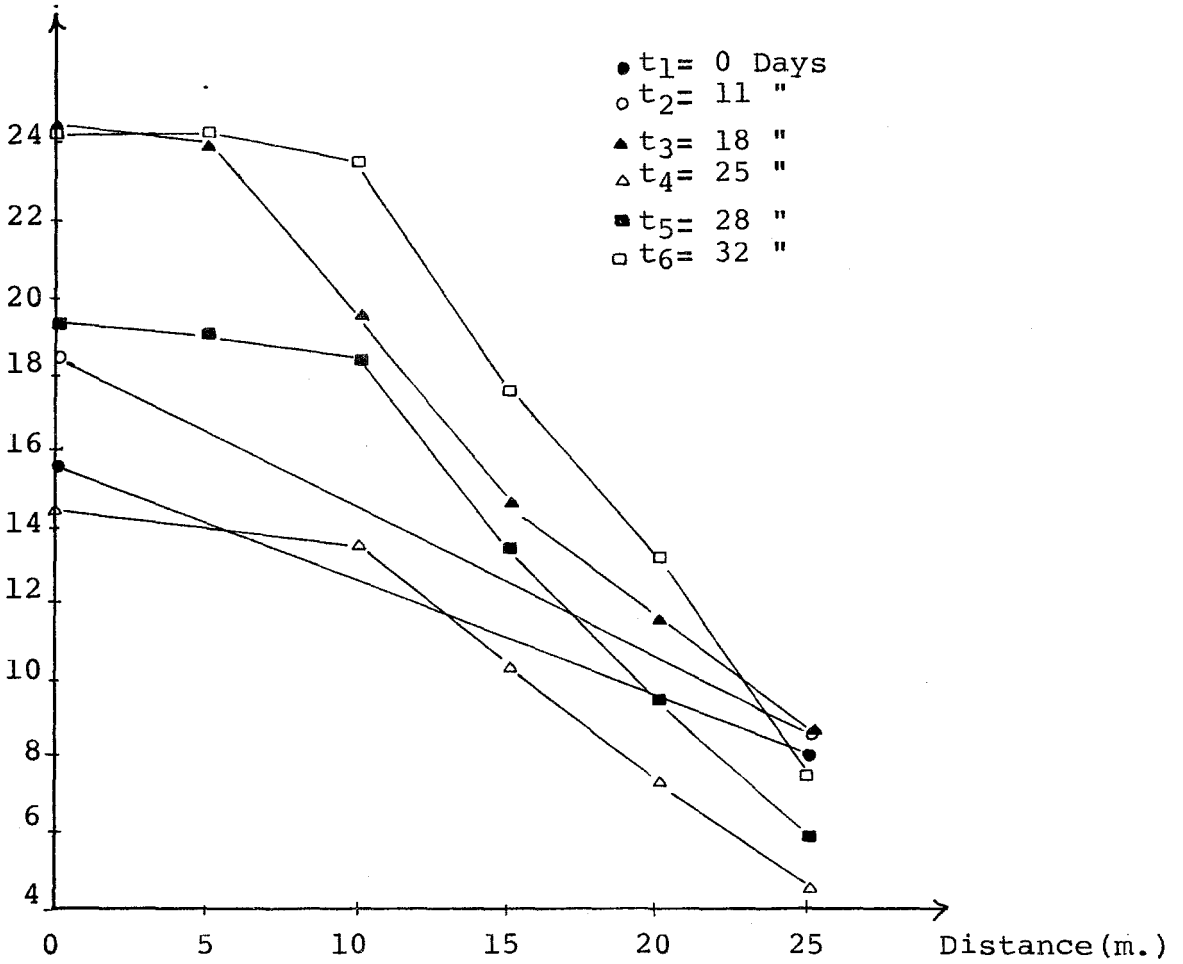

Figure 29 : Graphical Presentation Showing the Variation of Nitrogen with Distance in the Channel Full with Sand

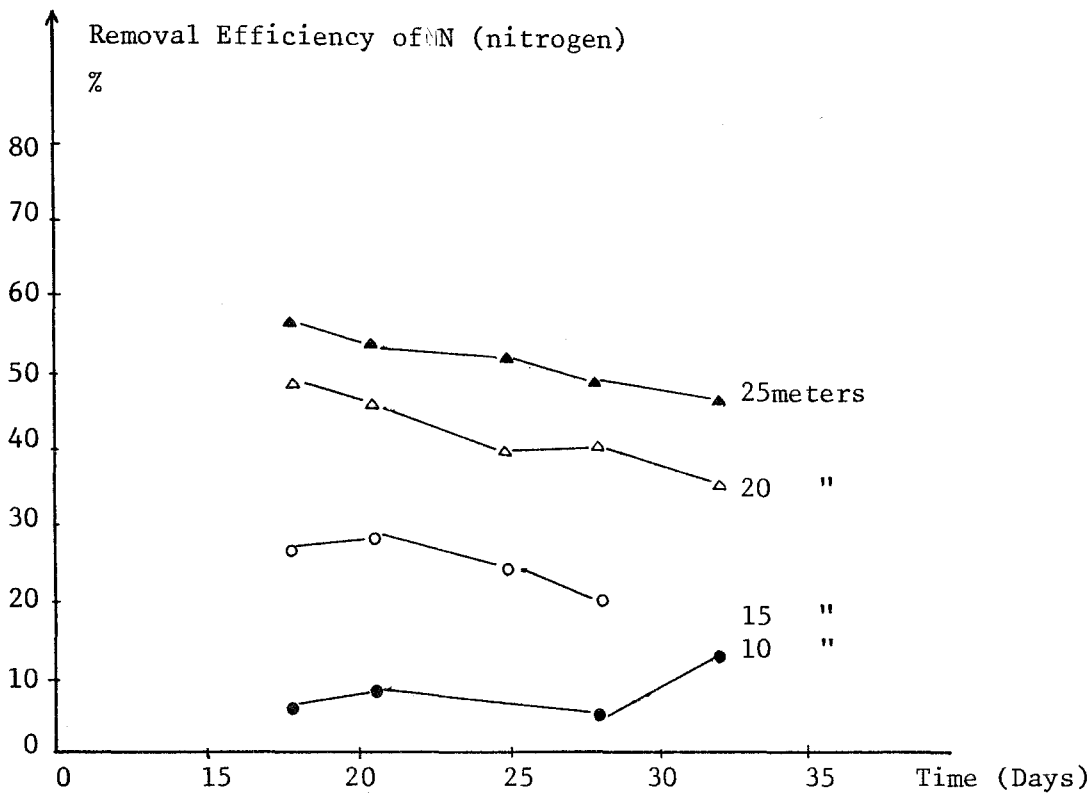

Figure 31 : Graphical Presentation of the Removal Efficiency of Nitrogen with Time in the Channel Full with Gravel

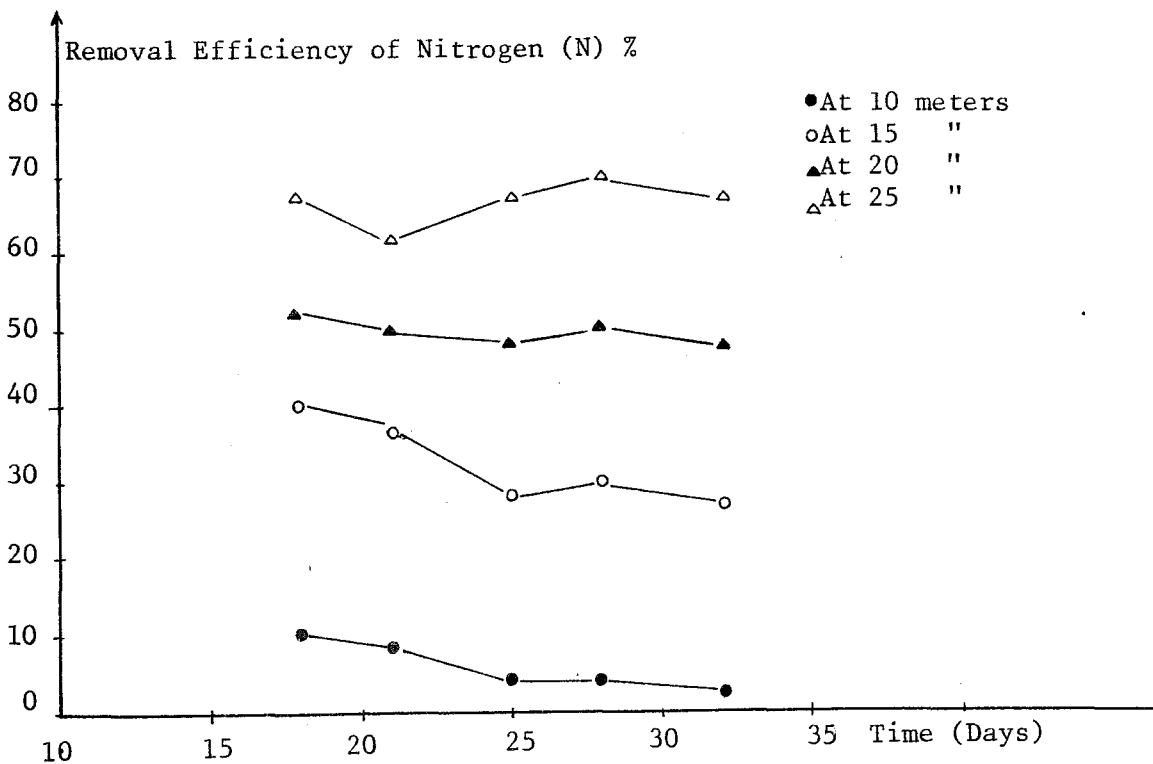

Figure 30 : Graphical Presentation of the Removal Efficiency of Nitrogen with Time in the Channel Full with Sand

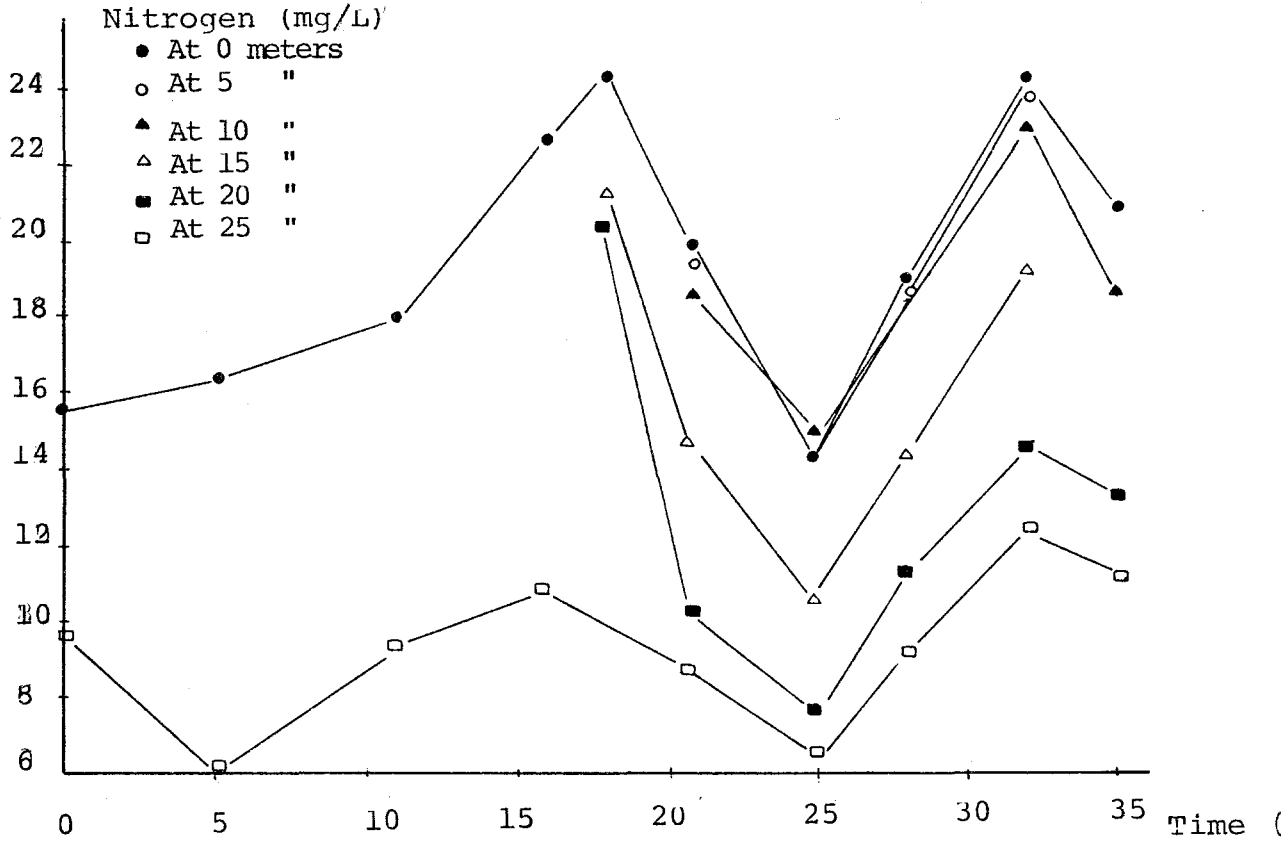

Figure 32 : Graphical Presentation Showing the Variation of Nitrogen with Time in the Channel Full with Gravel

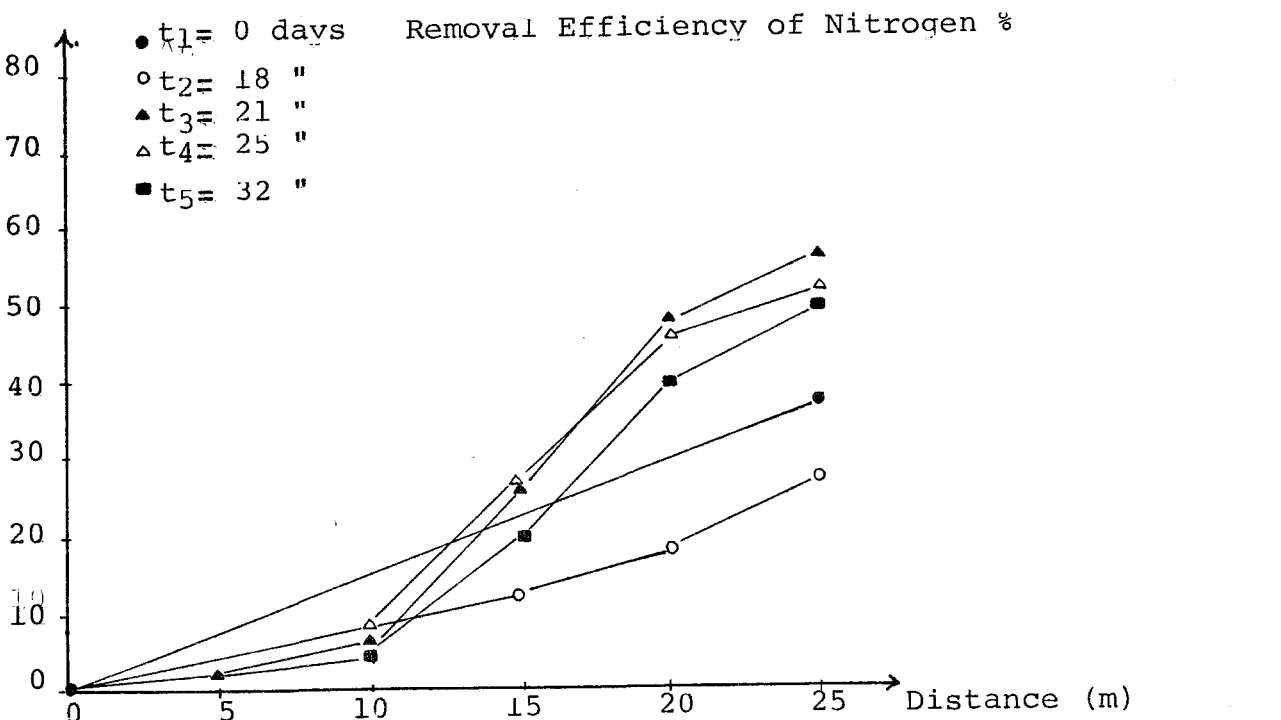

Figure 33 : Graphical Presentation Showing the Removal Efficiency of Nitrogen with Distance in the Channel Full with Gravel

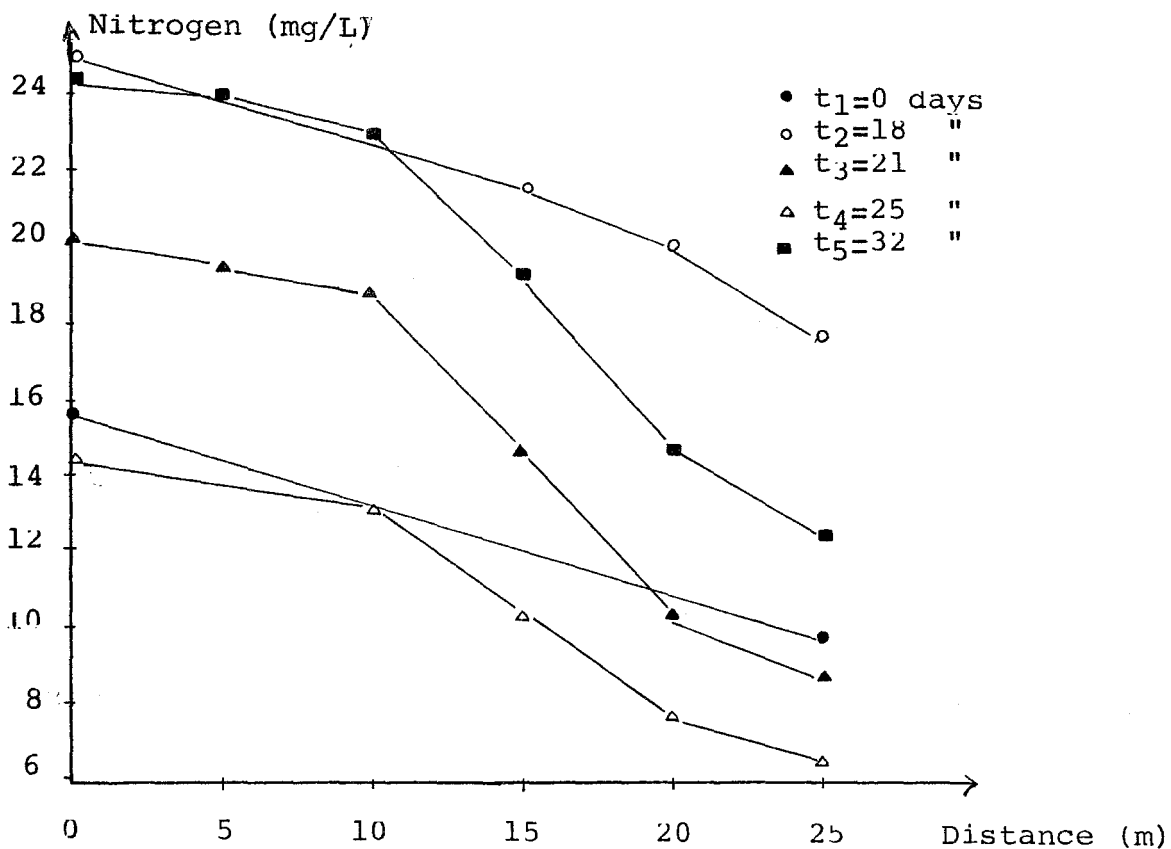

Figure 34 : Graphical Presentation Showing the Variation of Nitrogen with Distance in the Channel Full with Gravel

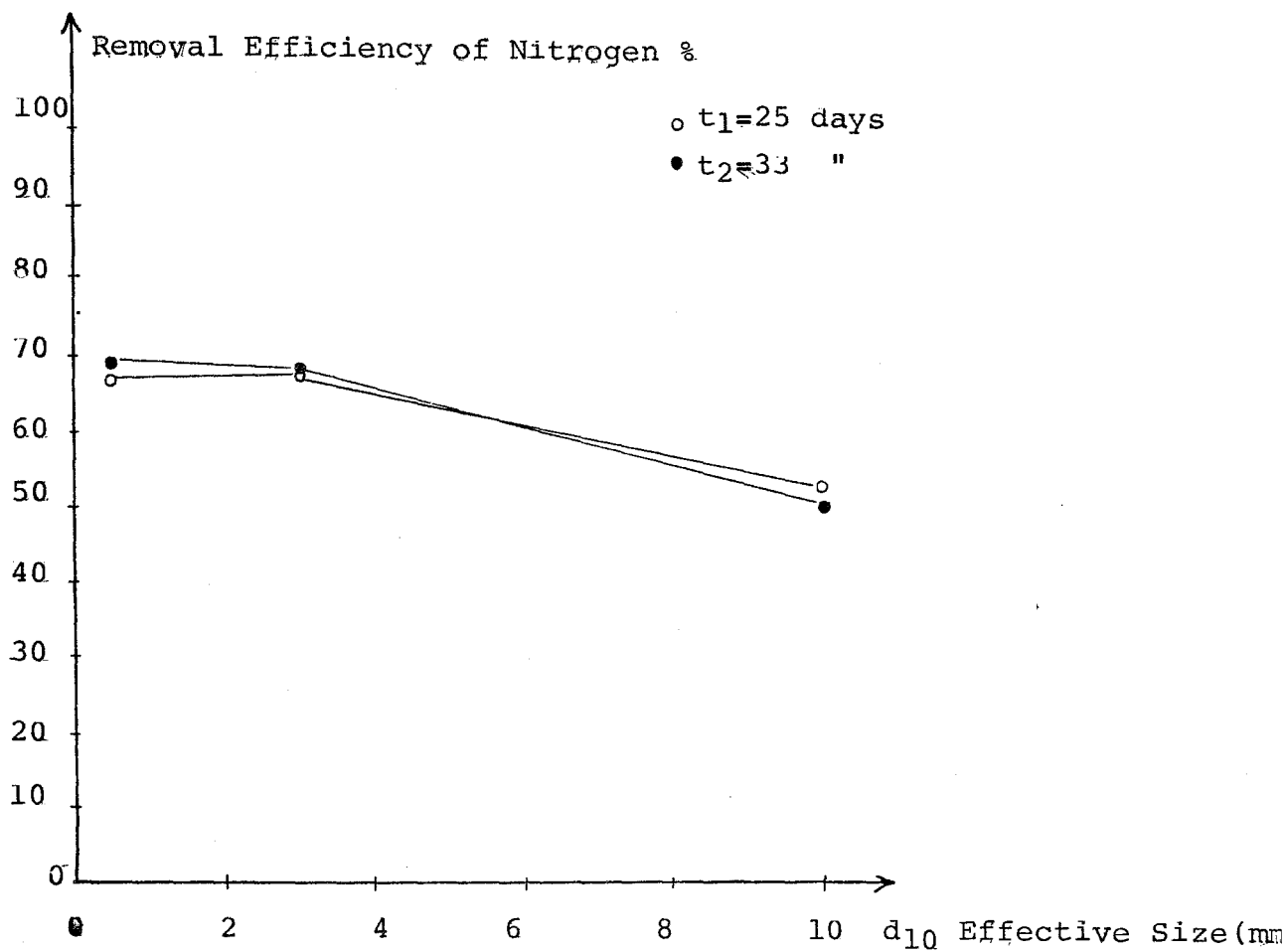

Figure 35 : Graphical Presentation Showing th Removal Efficiency of Nitrogen with the Effective Size

3.1.3.3 Phosphorus (P)

Phosphorus and nitrogen are necessary for the growth of plants, but if phosphorus reaches high levels it causes pollution.

The variation of phosphorus values with time and distance are presented graphically in the following figures.

The Figures 36, 37, 38 and 39 are related to sand and Figures 40, 41, 42 and 43 are related to gravel.

According to these figures, the following conclusions can be reached.

- i) The removal efficiency of phosphorus is increasing with time.
- ii) The removal efficiency of phosphorus is also increasing with distance.

The overall percent of phosphorus removal is 64% in gravel bed and is 77% in sand bed.

Sanks and Asano (1976) pointed that the removal efficiency of phosphorus was between 60-80% of overland runoff and 50-90% of rapid infiltration.

Figure 44 shows the variation of removal efficiency with the effective size of the filter media. This figure shows that the removal percent of phosphorus is reduced with increasing effective diameter.

3.1.3.4 Solids

Solids are another impurity present in wastewater. The variation of total and suspended solids between 0 meter and 25 meters of each channel were determined.

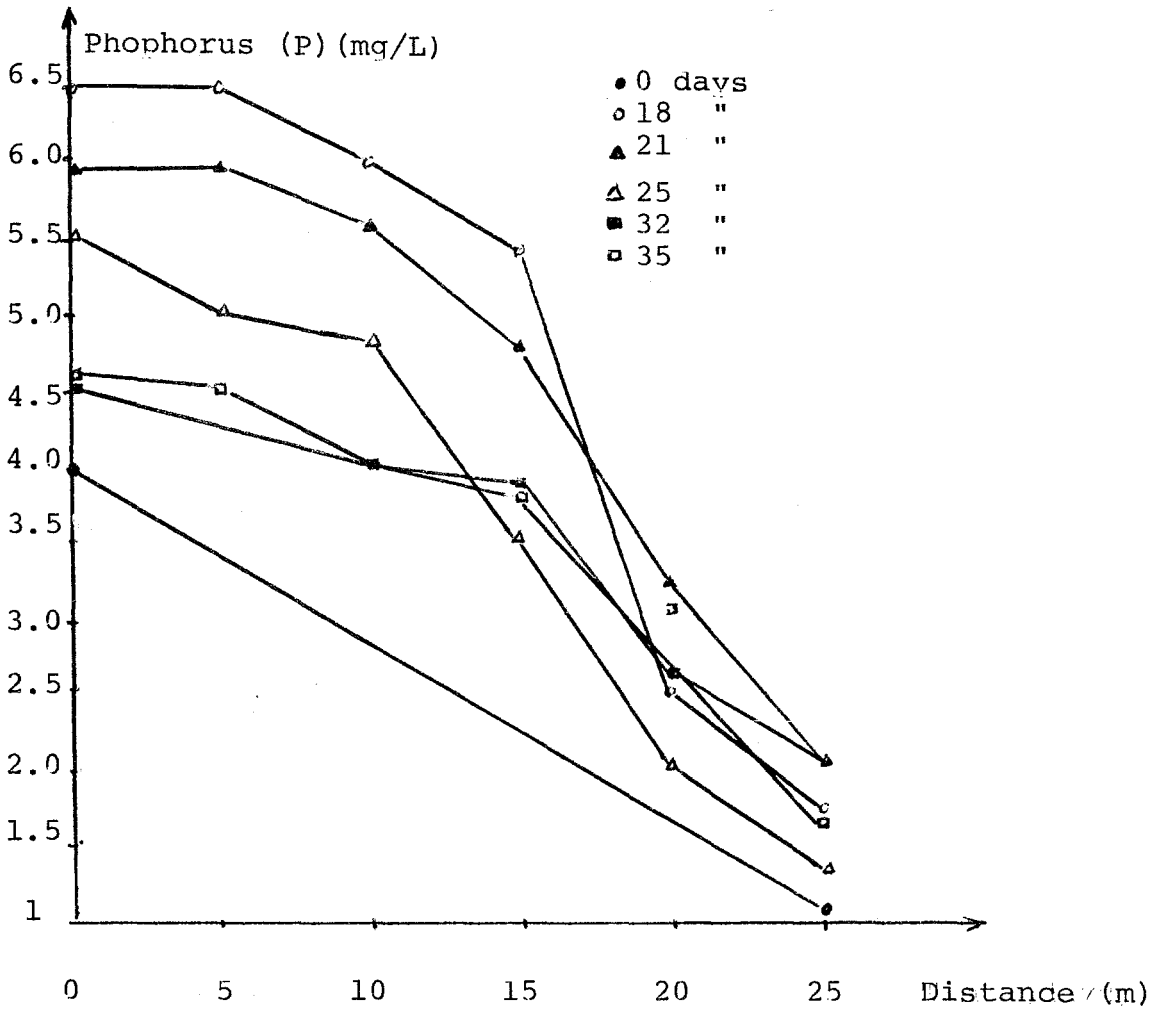

Figure 36 : Variation of Phosphorus with Distance in the Channel Full with Sand

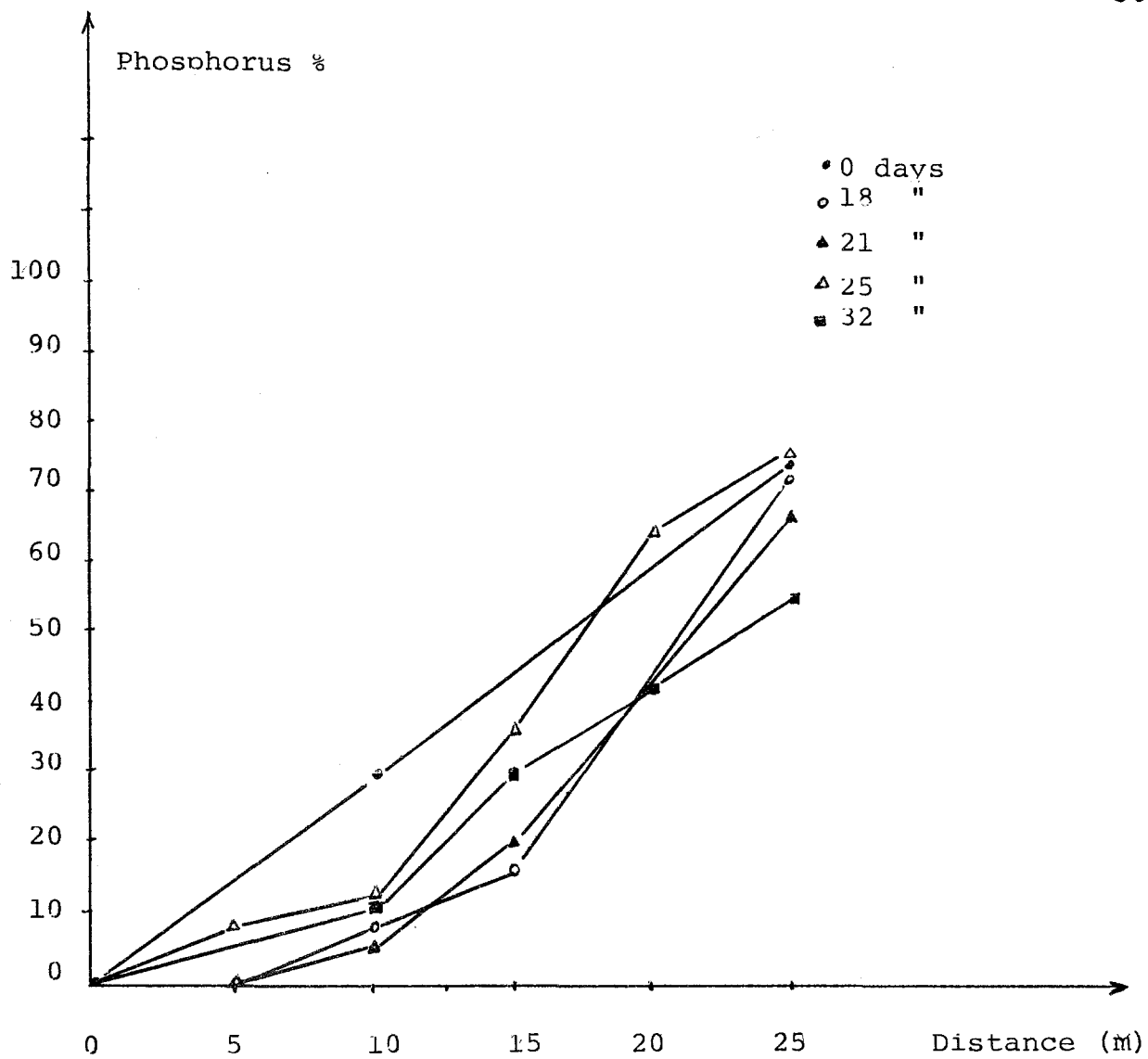

Figure 37 : Removal Efficiency of Phosphorus with Distance in the Channel Full with Sand

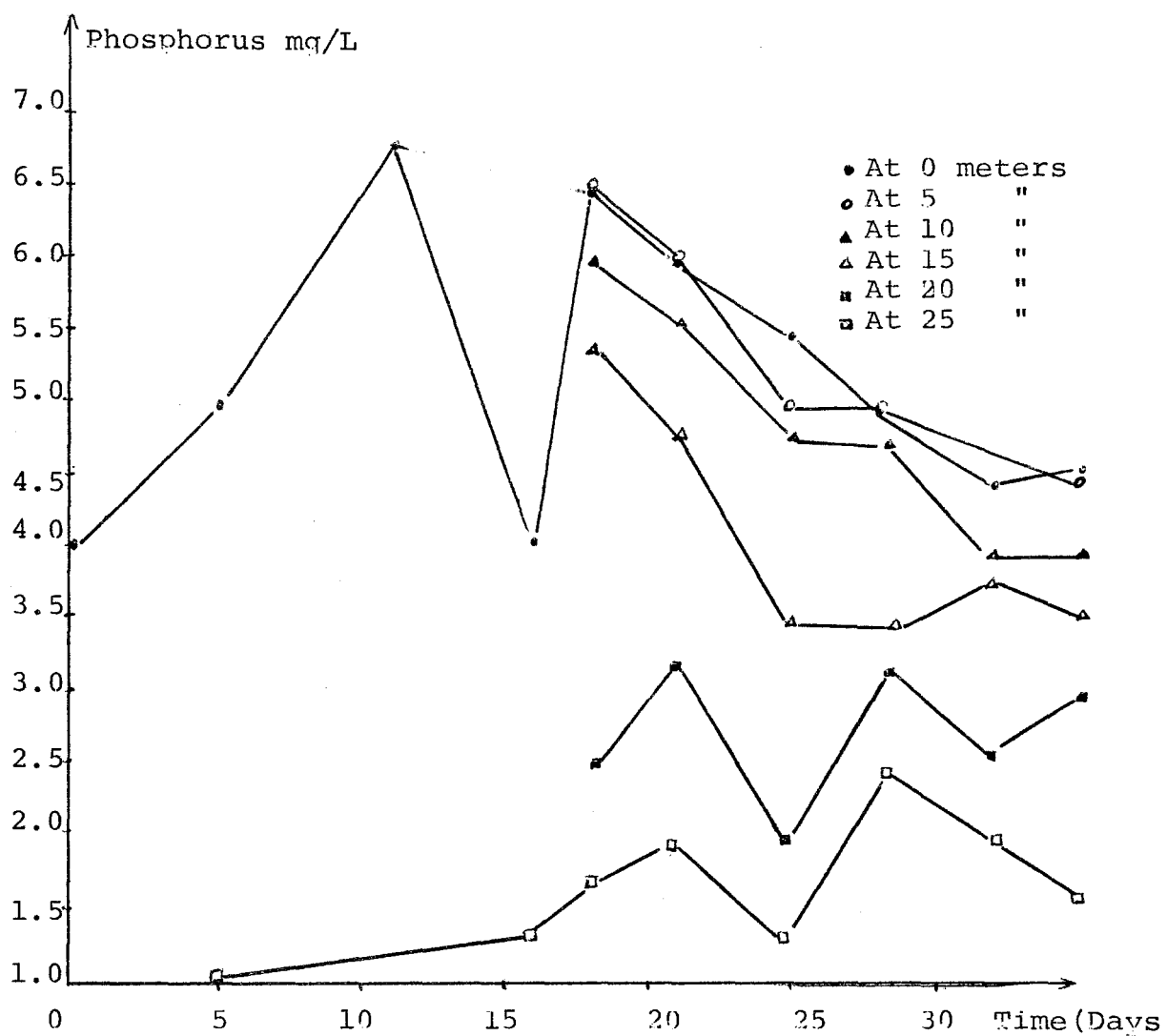

Figure 38 : Variation of Phosphorus with Time in the Channel Full with Sand

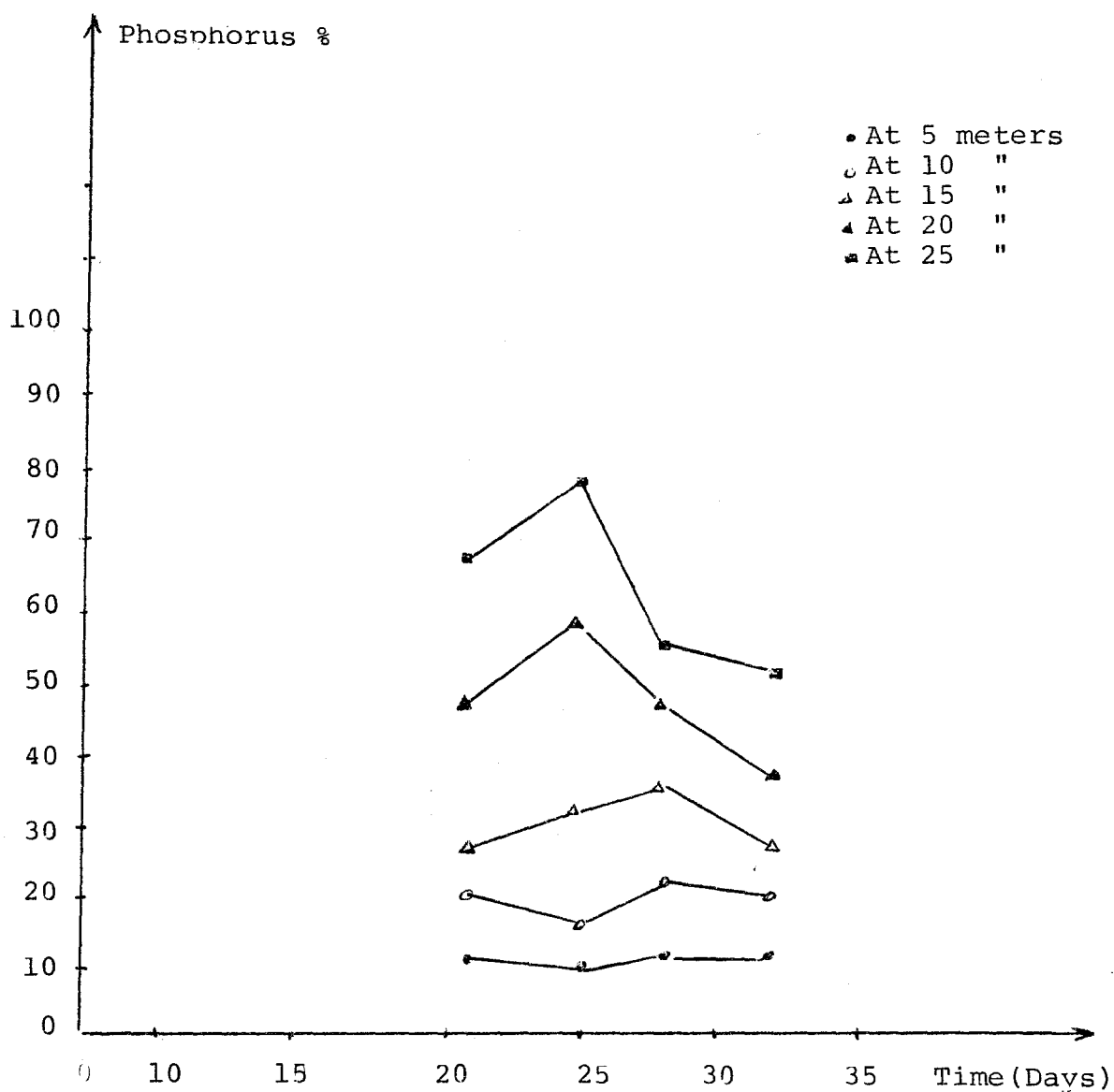

Figure 39 : Removal Efficiency of Phosphorus with Time
in the Channel Full with Sandal

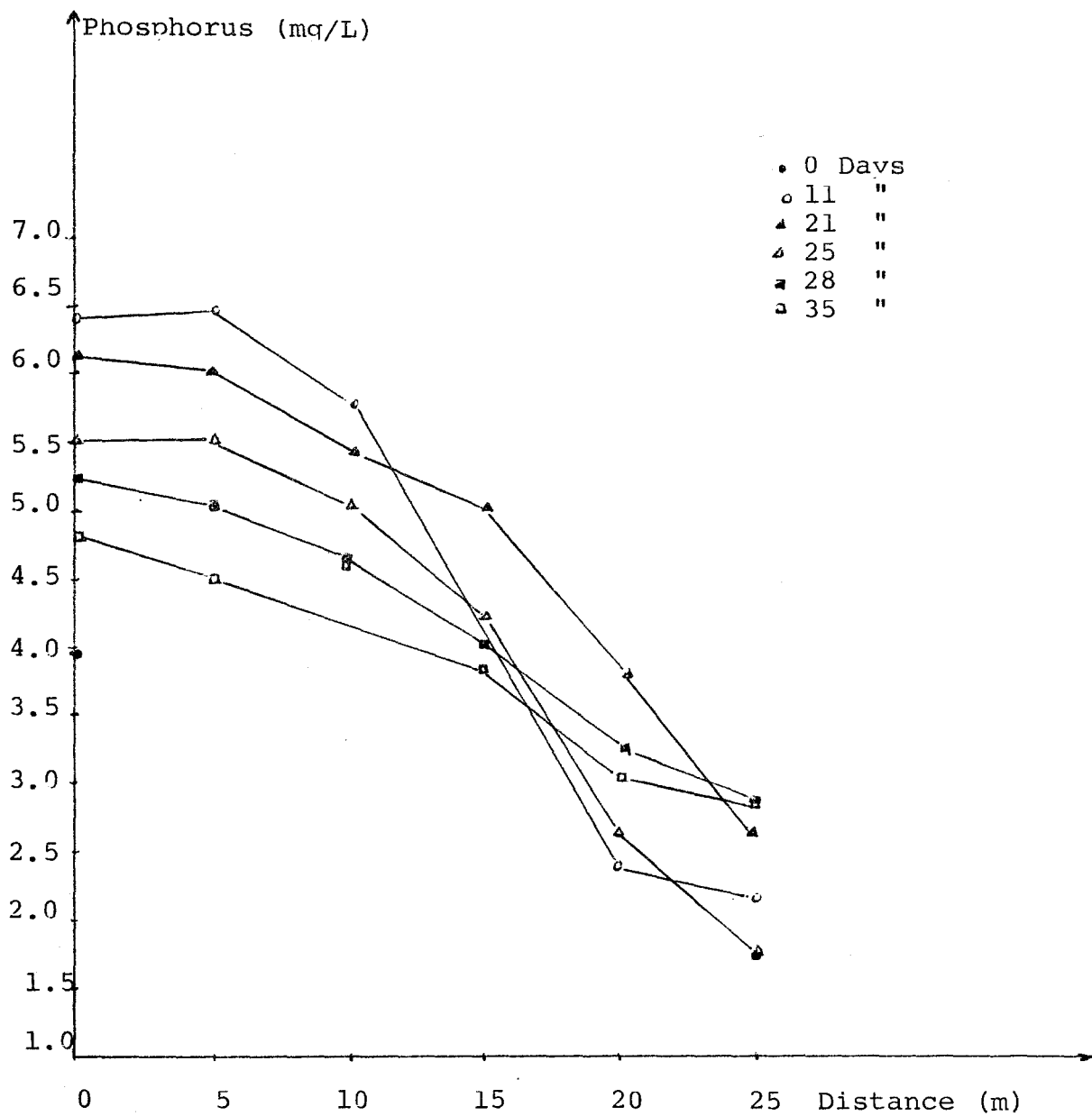

Figure 40 : Variation of Phosphorus with Distance in the Channel Full with Gravel

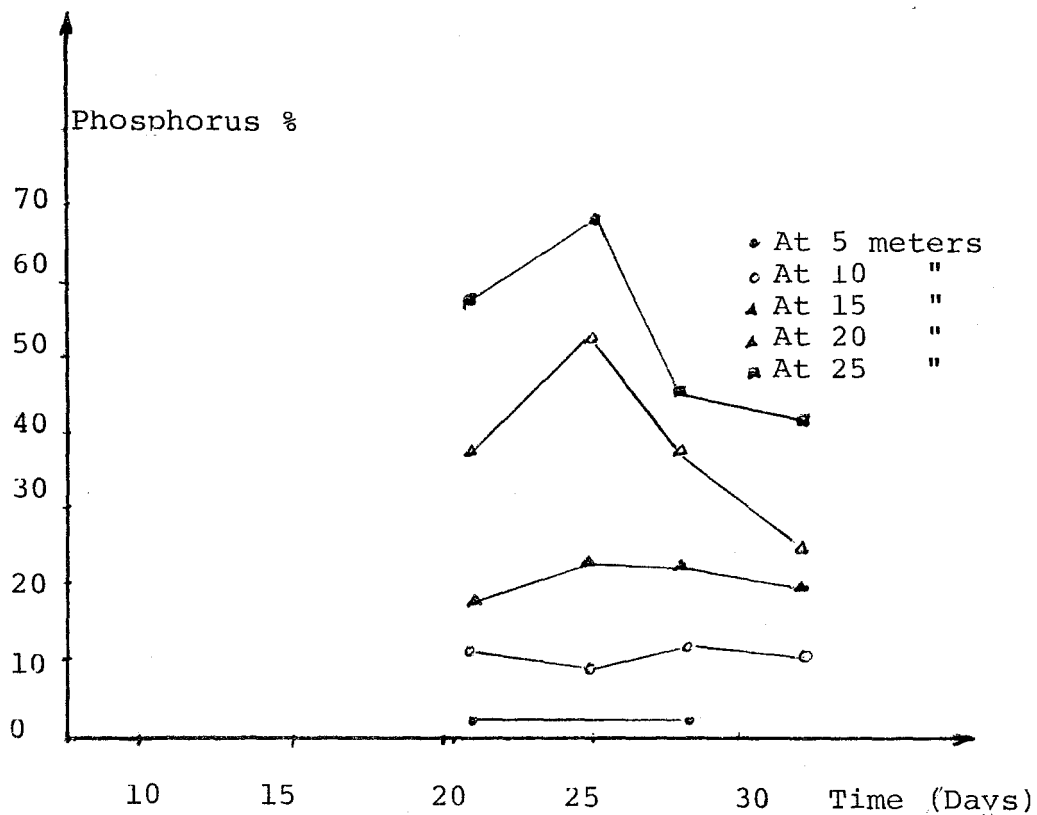

Figure 41 : Removal Efficiency of Phosphorus with Time in the Channel Full with Gravel

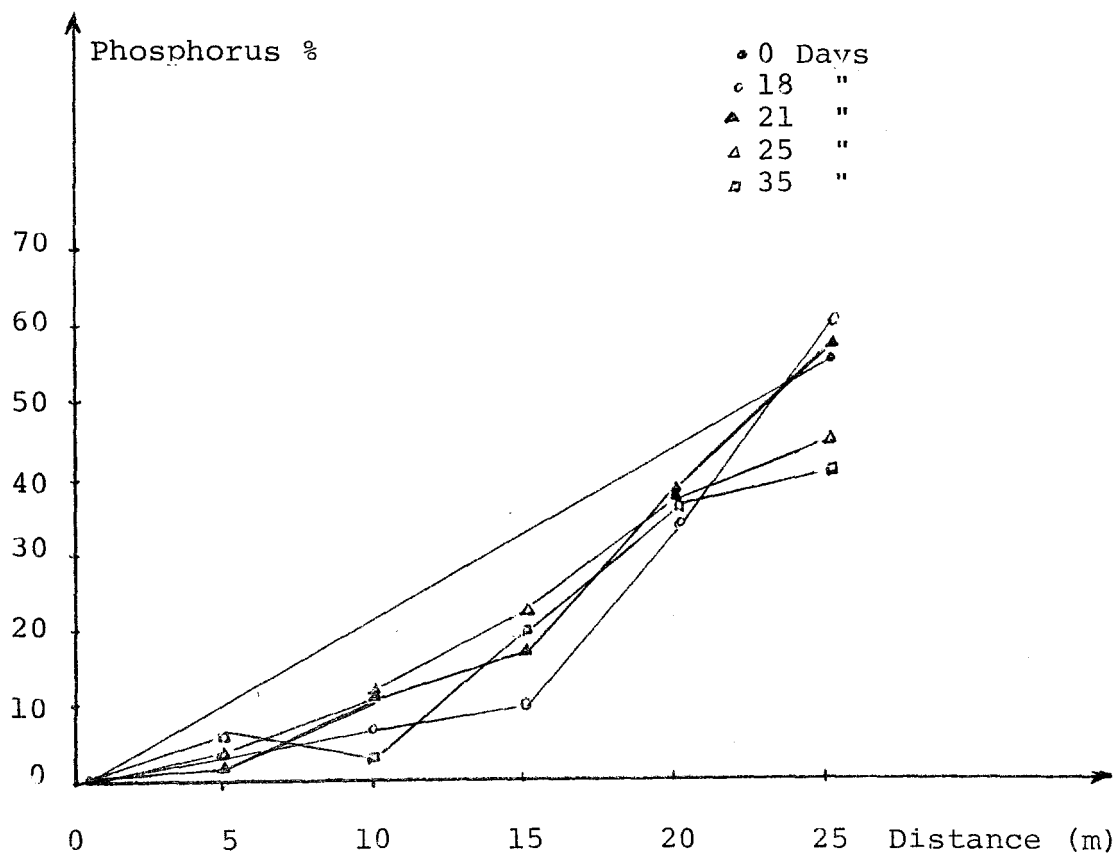

Figure 42 :

Removal Efficiency of Phosphorus with Distance in the Channel Full with Gravel

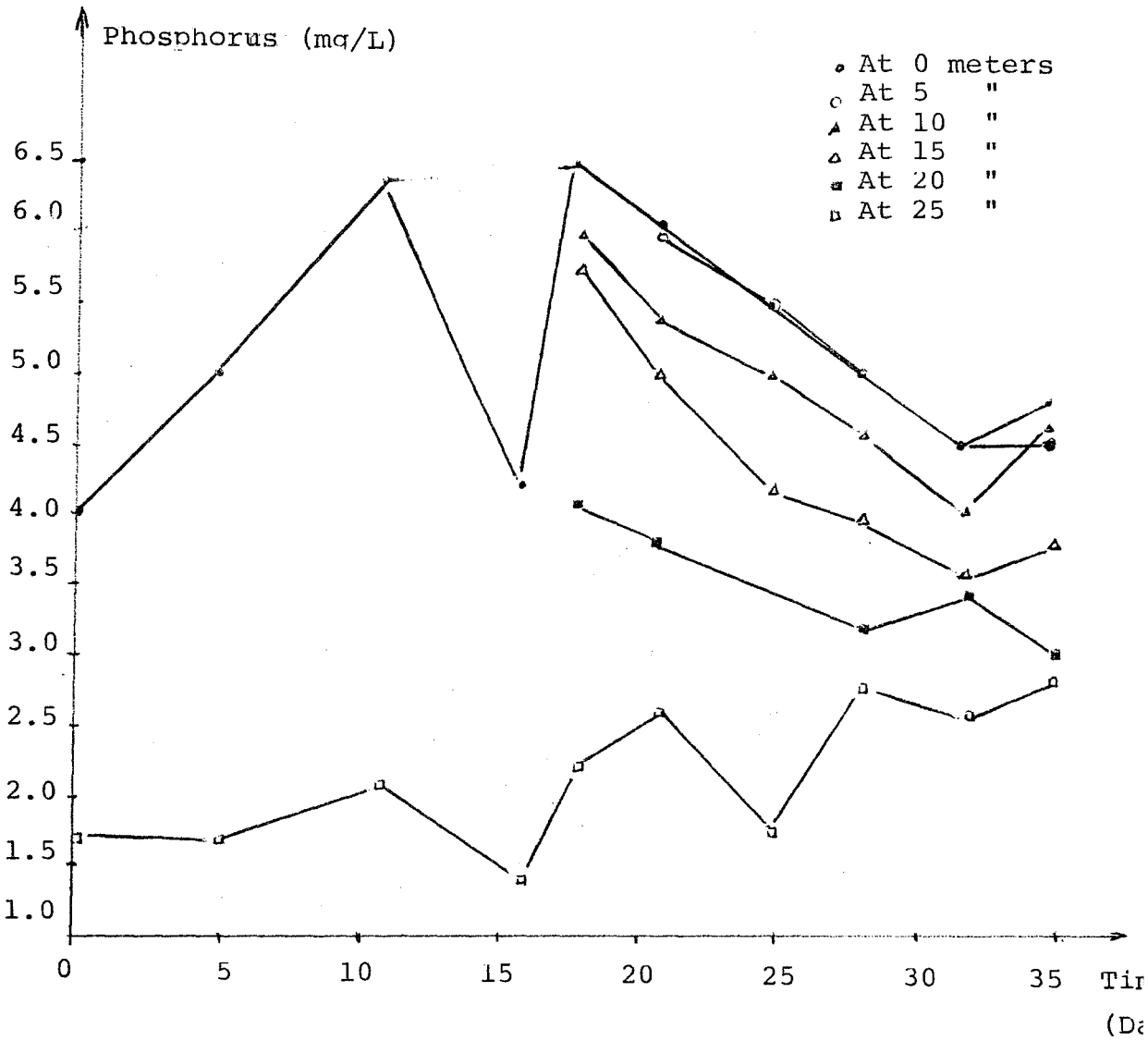

Figure 43 : Variation of Phosphorus with Time in the Channel Full with Gravel

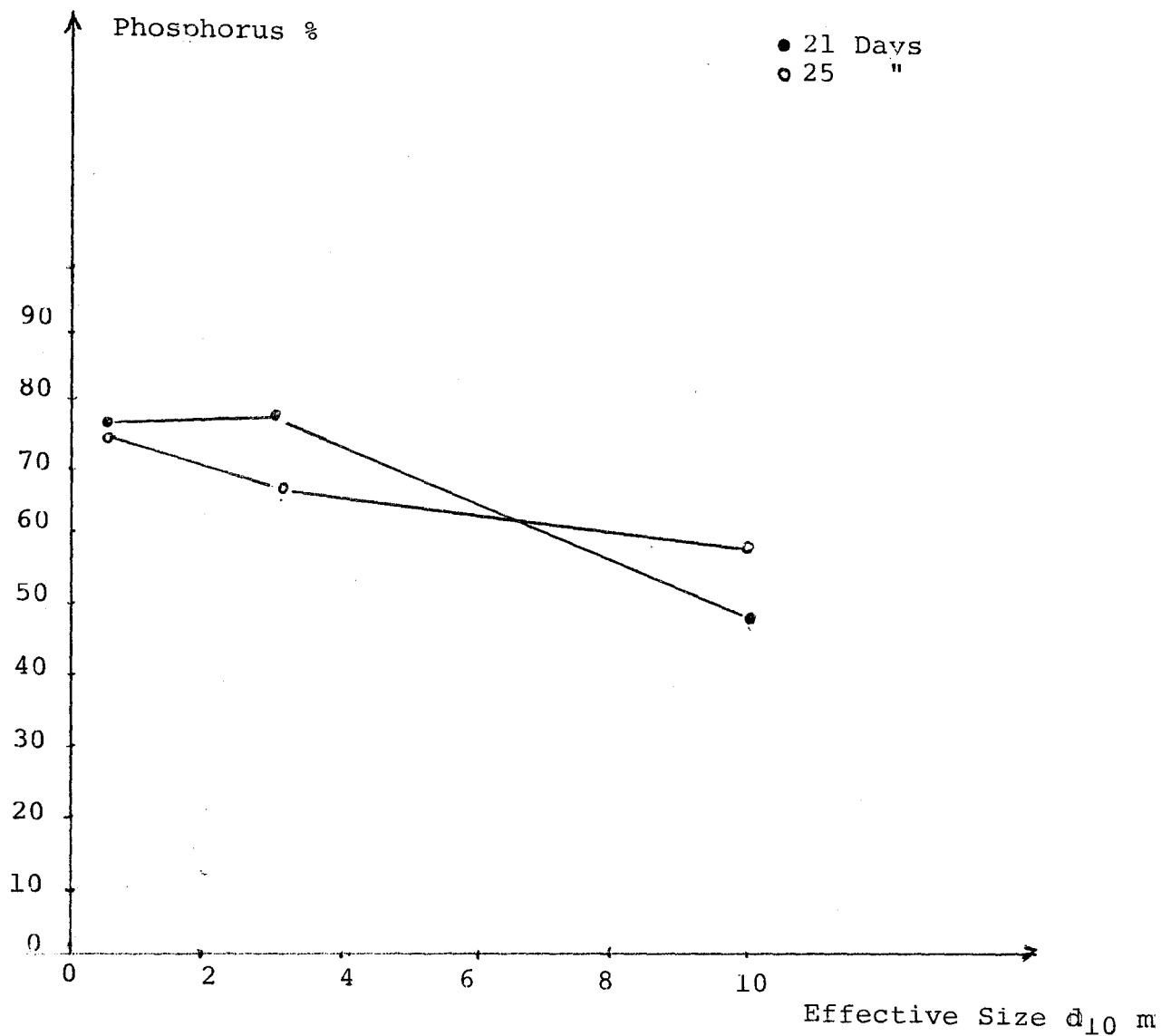

Figure 44 : Removal Efficiency of Phosphorus with Effective Size of Porous Media

In the following figures, the variation of total and suspended solids are shown. As can be seen in Figure 45, the removal efficiency obtained is relatively low.

The reason of the low results obtained may be due to the removal of some solids present initially in the sand bed during the experiment.

3.1.3.5 Turbidity

Figures 46 and 47 show the variation of turbidity values with time and distance. The removal efficiency of turbidity with time is shown in Figure 48 and with distance in Figure 49.

Figures 50, 51, 52 and 53 show the variation of turbidity in the gravel bed. As can be seen in these figures, effluent turbidity values decrease with time.

The turbidity removal efficiency is decreasing with effective size (Figure 54).

3.1.3.6 pH

Figures 55 and 56 show that there is a slight decrease in pH with time and the effluent values are always higher than the influent values. The reason for this may be salts present in the soil media.

3.1.3.7 Coliform

Microorganisms and parasites which are present in the wastewater may cause a large variety of diseases. Coliform is an indicator of these organisms. That is why the removal of coliform has been investigated.

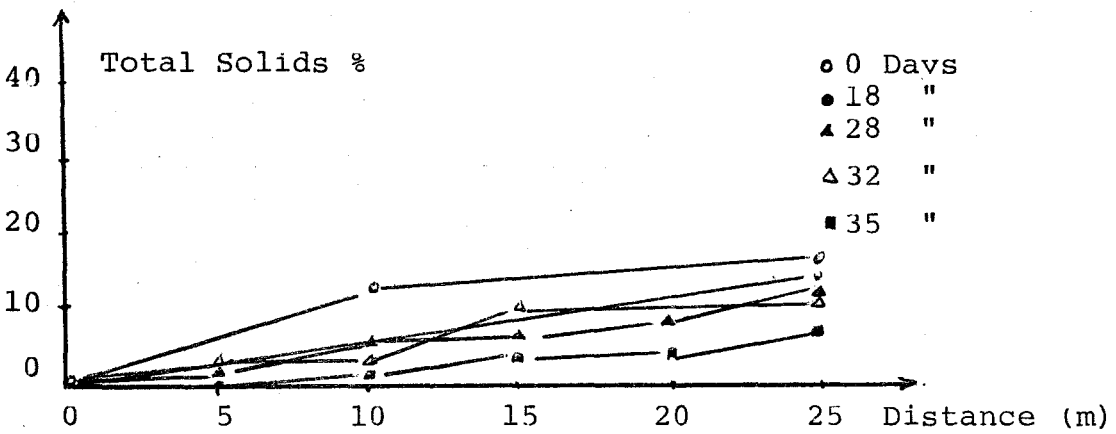
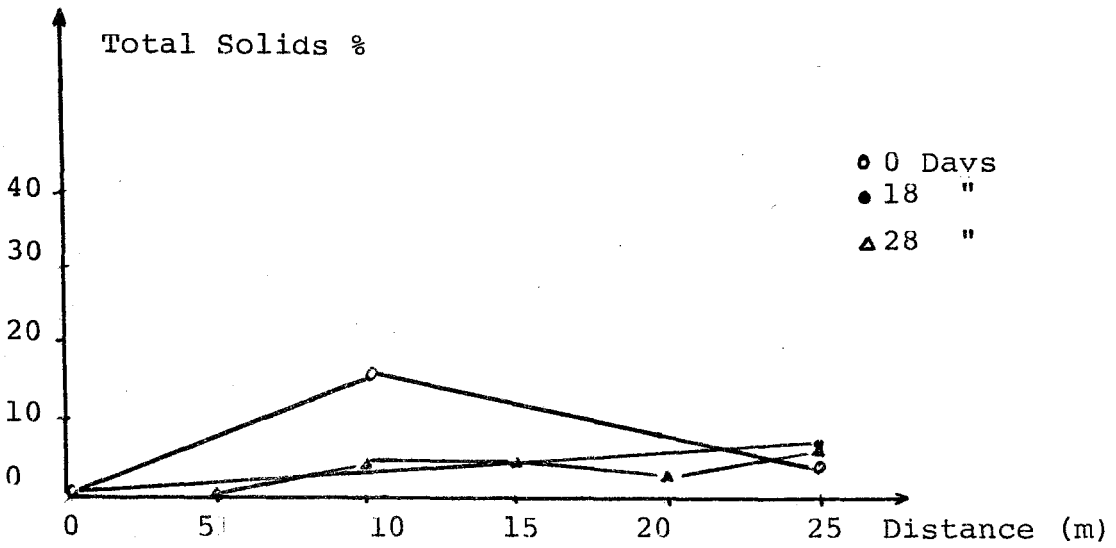

Figure 45 a :Removal Efficiency of Total Solids in the Channel Full with Gravel
 b :Removal Efficiency of Total Solids in the Channel Full with Sand

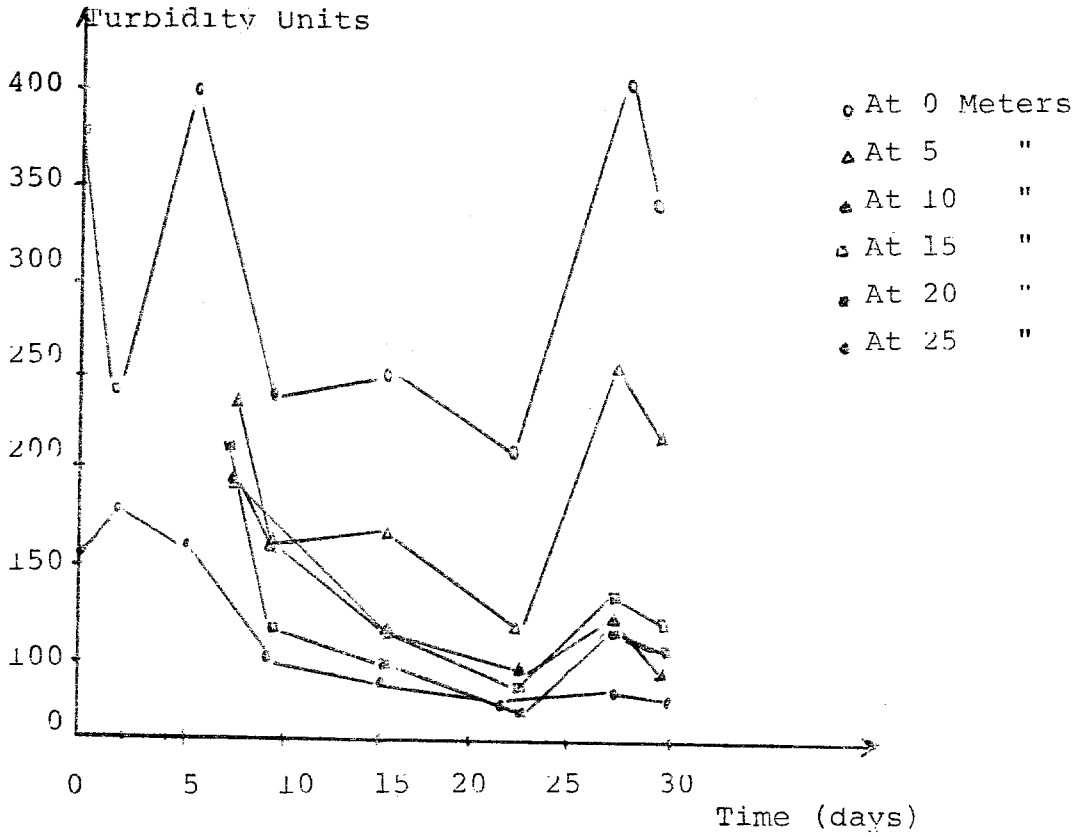

Figure 46 : Variation of Turbidity with Time in the Channel Full with Sand

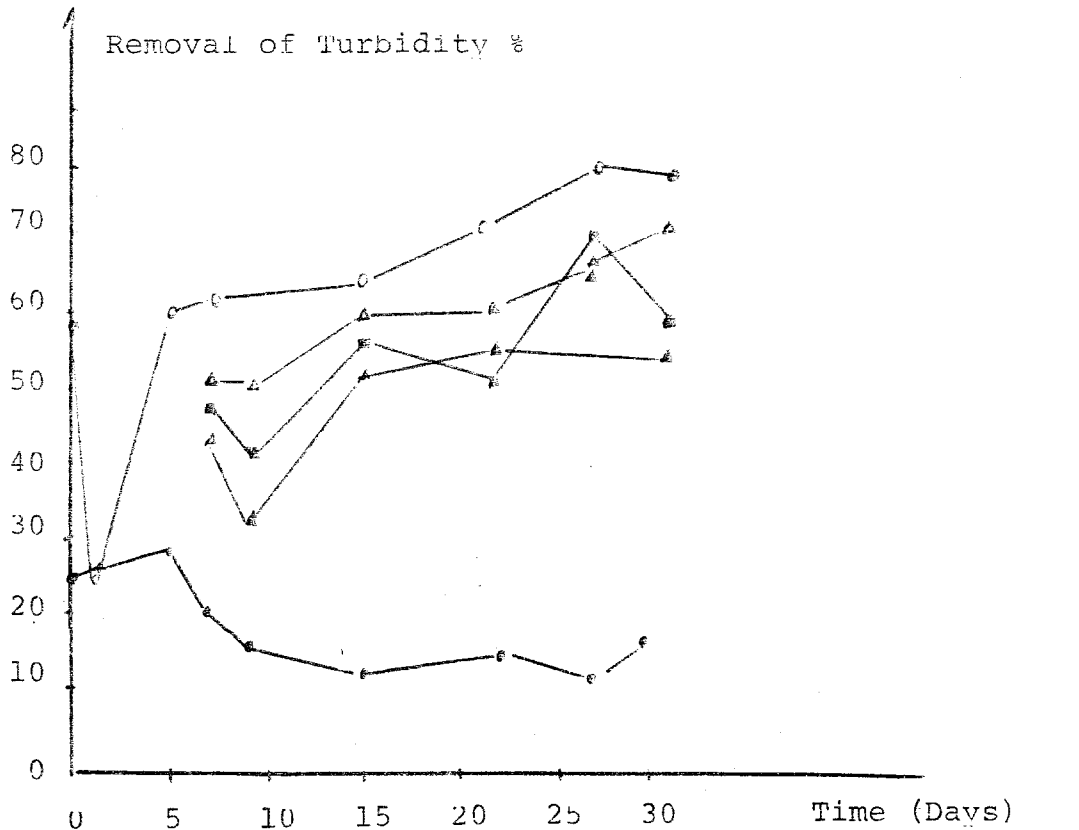

Figure 47 : Removal of Turbidity with Time in the Channel Full with Sand

Turbidity Units

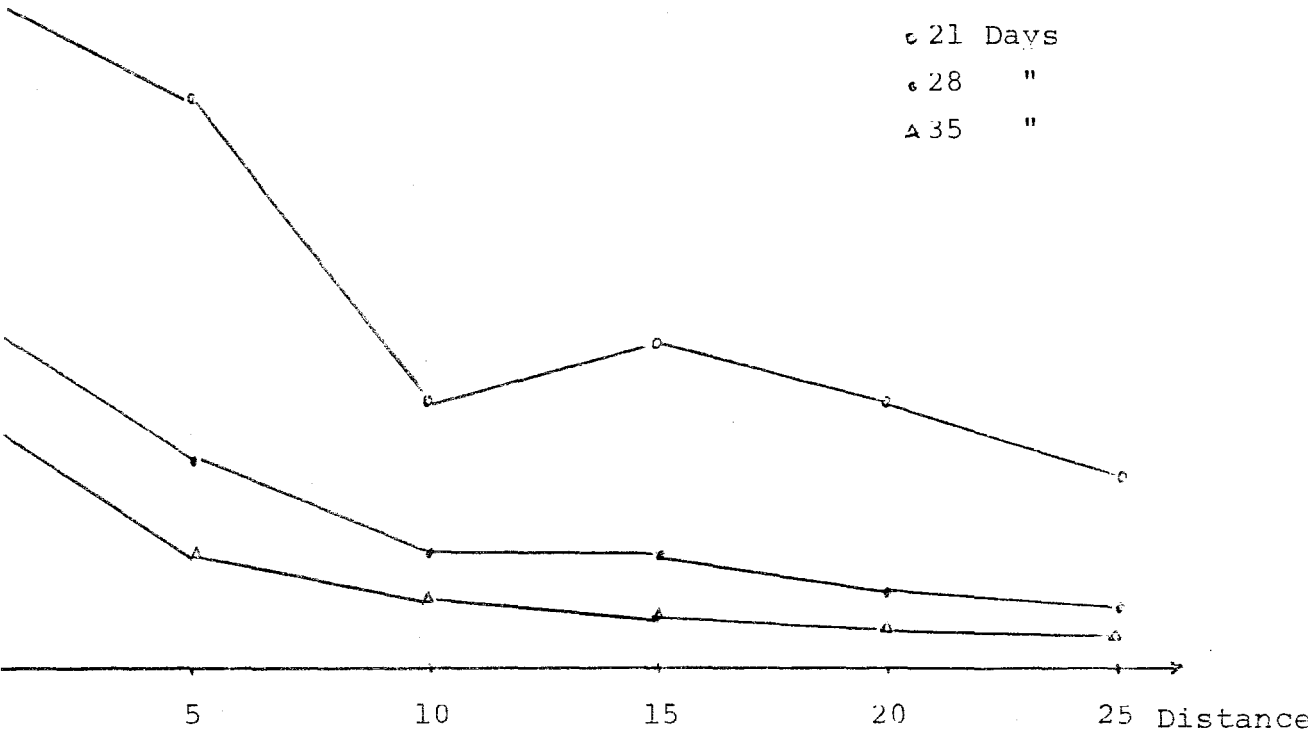

Figure 48 : Variation of Turbidity with Distance in the Channel Full with Sand

Removal of Turbidity

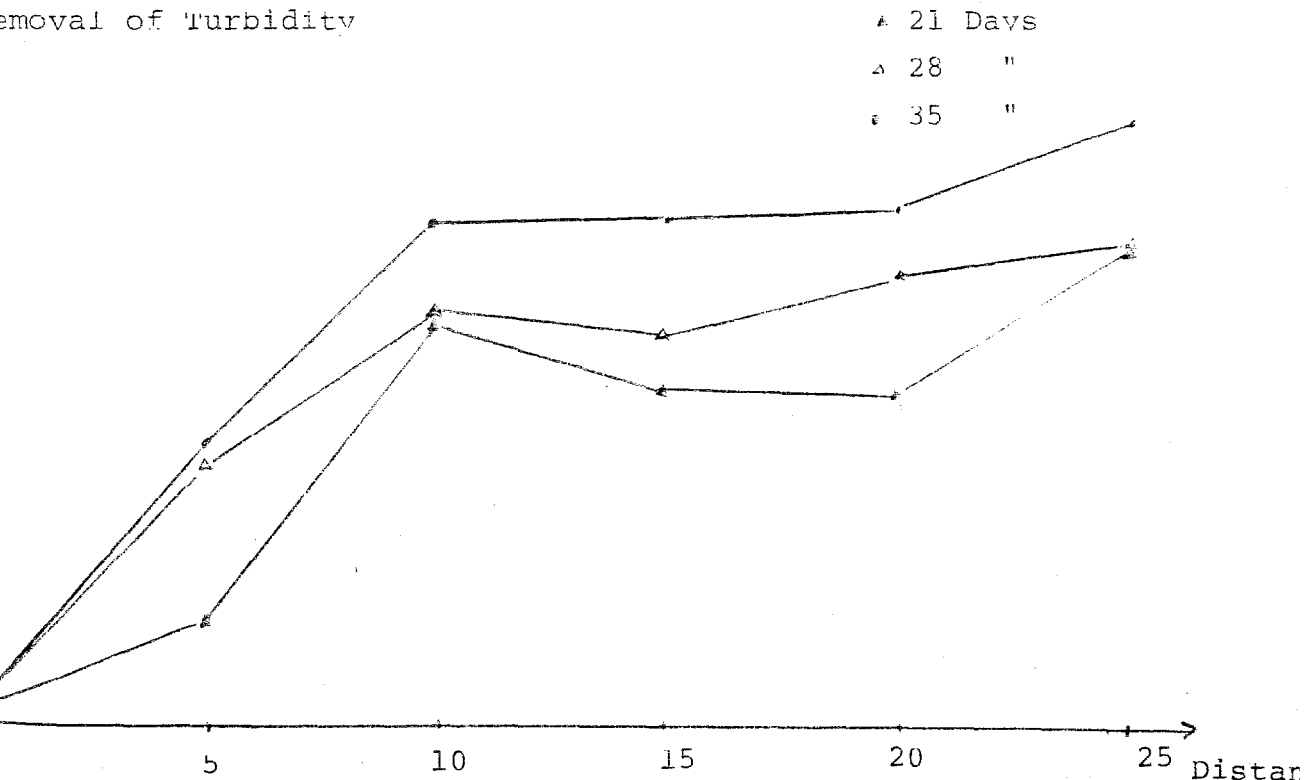

Figure 49 : Removal Efficiency of Turbidity with Distance in the Channel Full with Sand

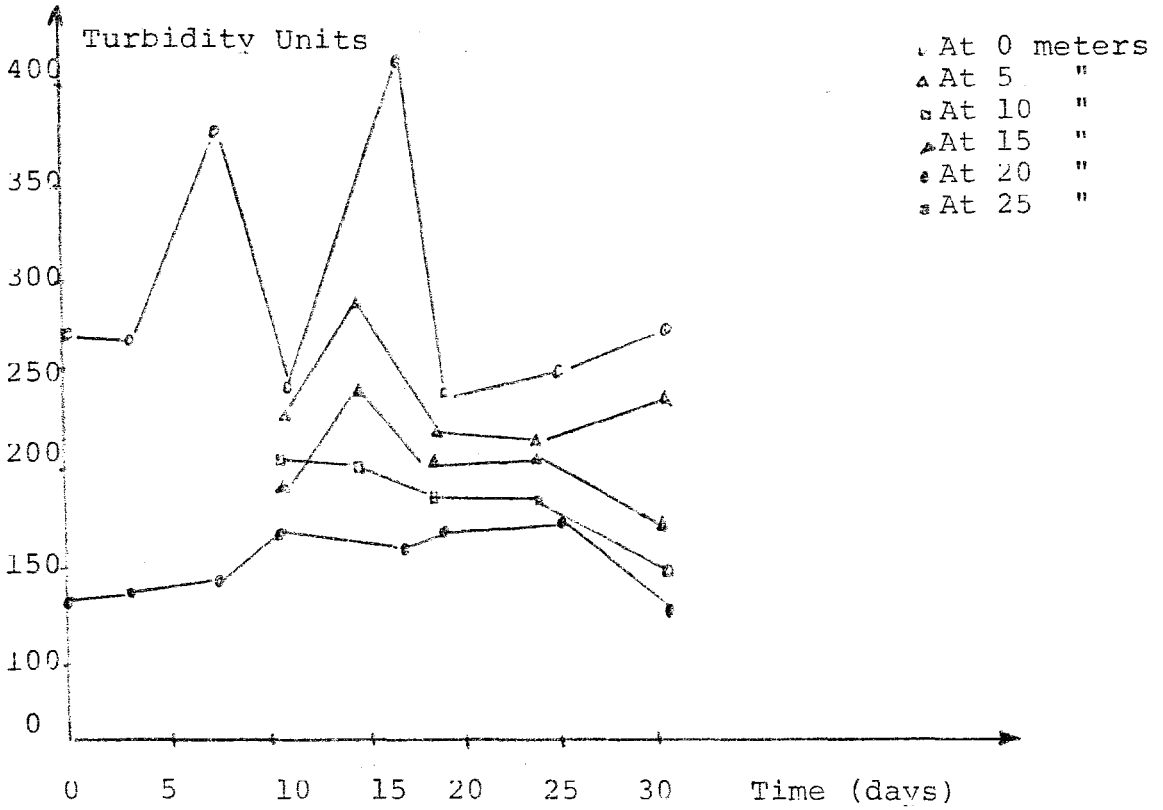

Figure 50 : Variation of Turbidity with Time in the Channel Full with Gravel

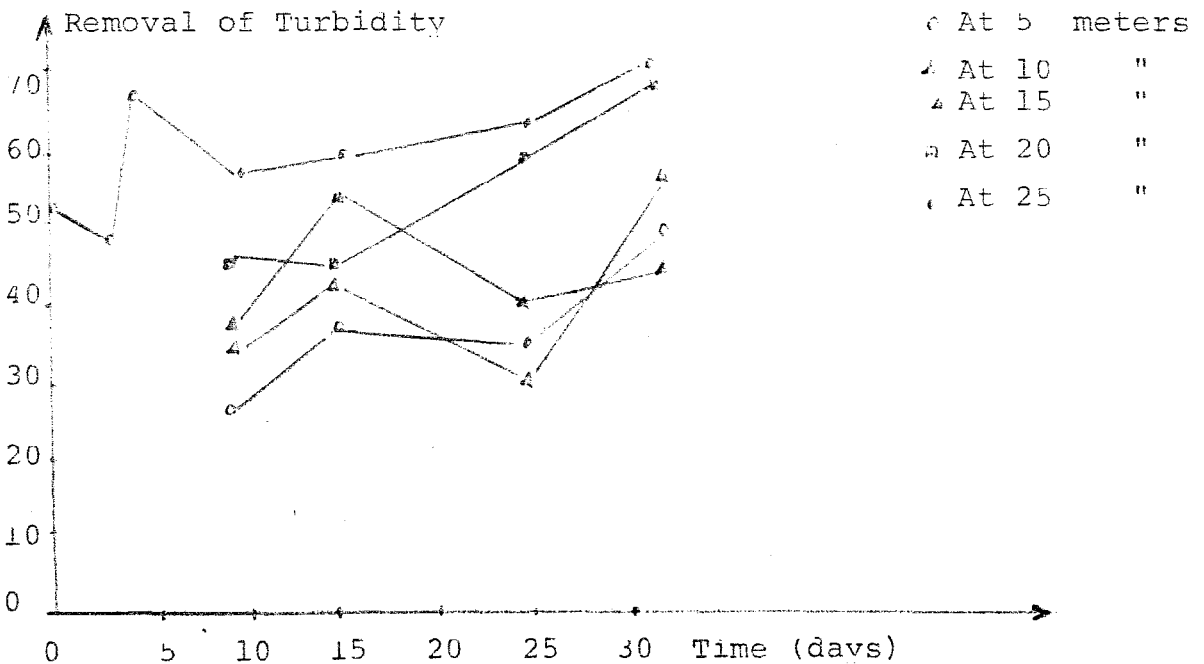

Figure 51 : Removal Efficiency of Turbidity with Time in the Channel Full with Gravel

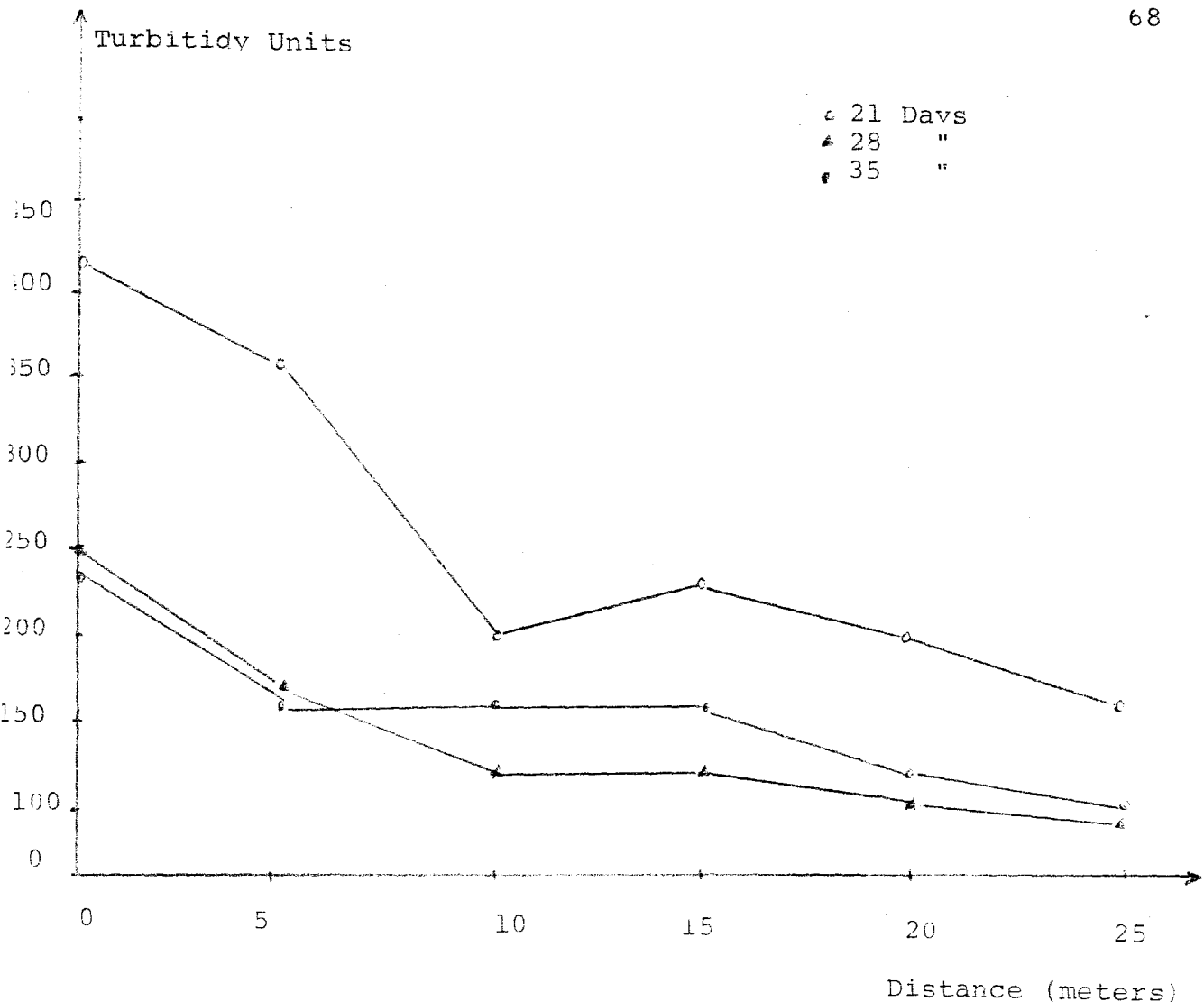

Figure 52 : Variation of Turbidity with Distance in the Channel Full with Gravel

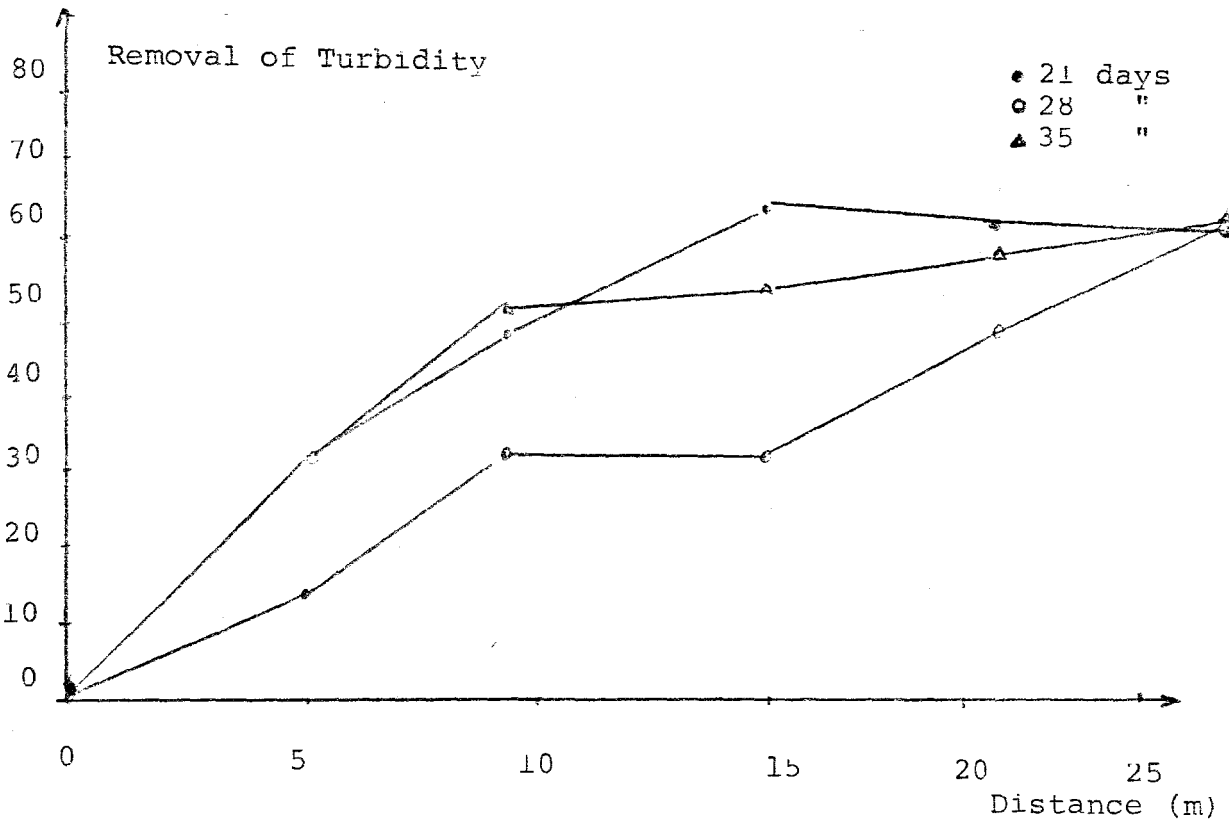

Figure 53 : Removal Efficiency of Turbidity with Distance in the Channel Full with Gravel

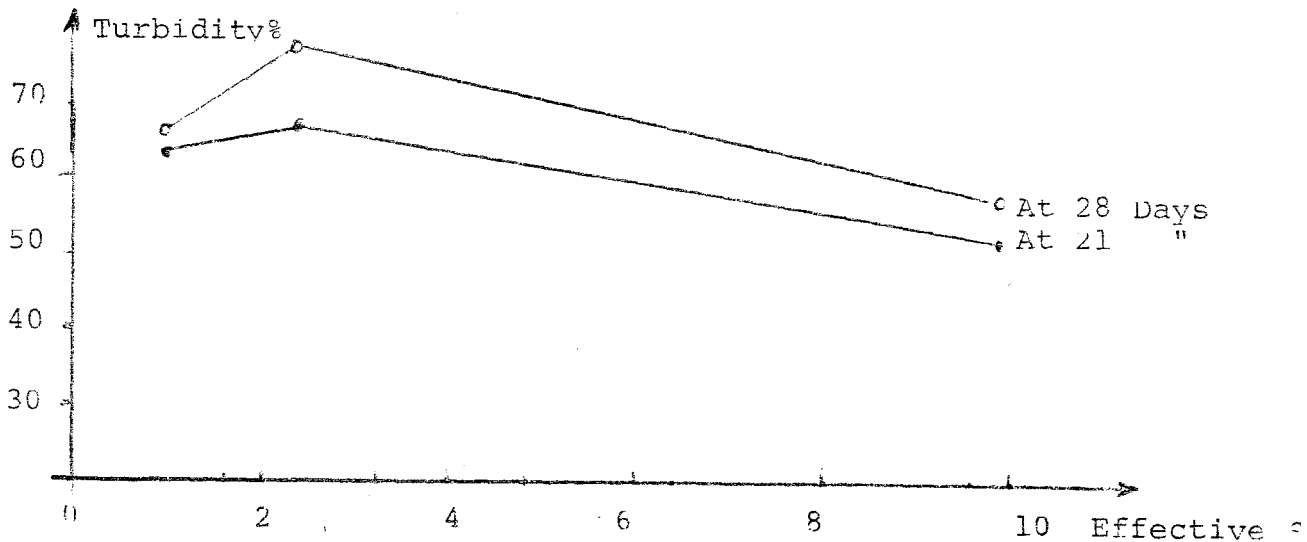

Figure 54 : Removal Efficiency of Turbidity with Effective size of Porous Media

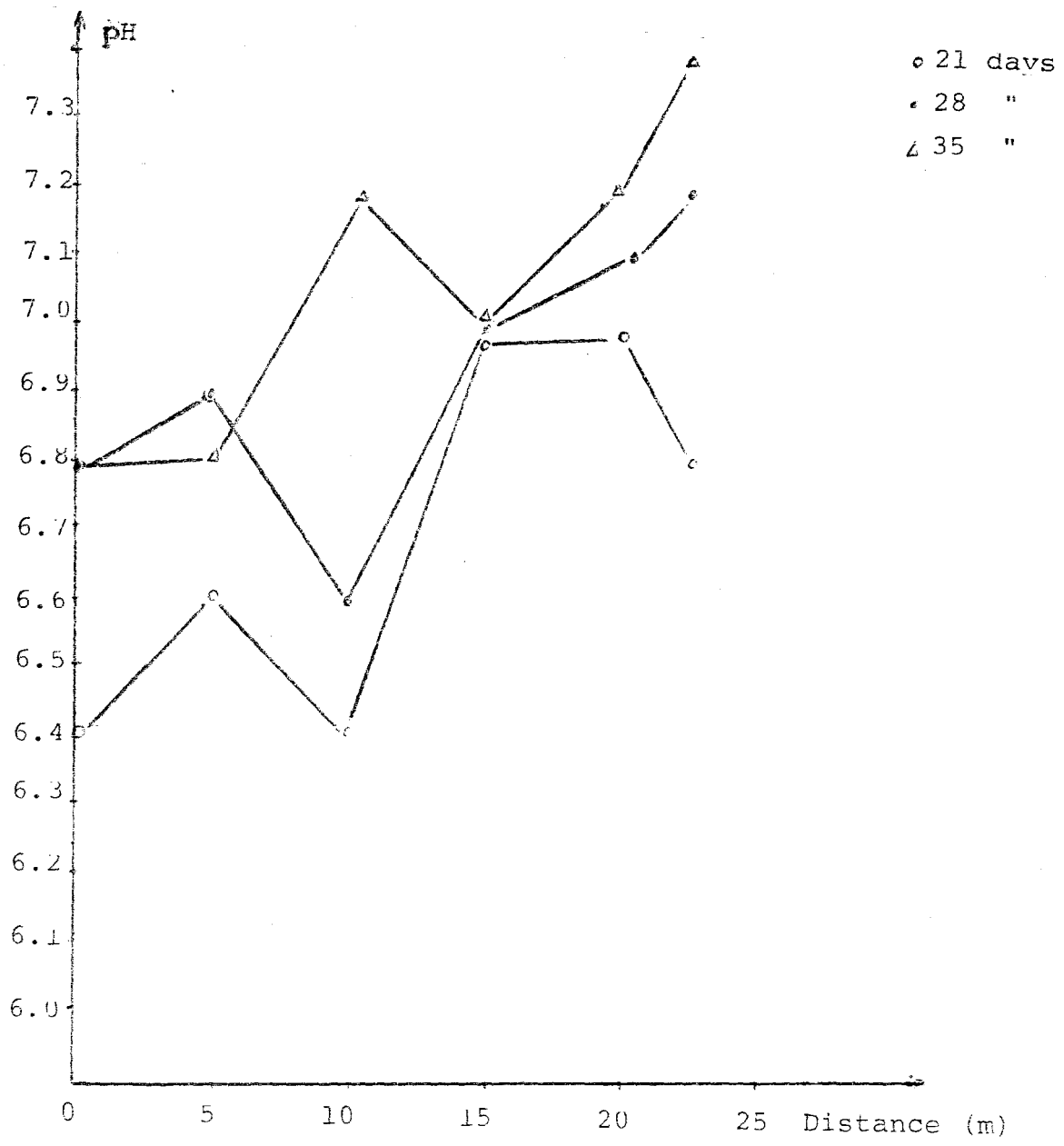

Figure 55 : Variation of pH with Distance in the Channel Full with Sand

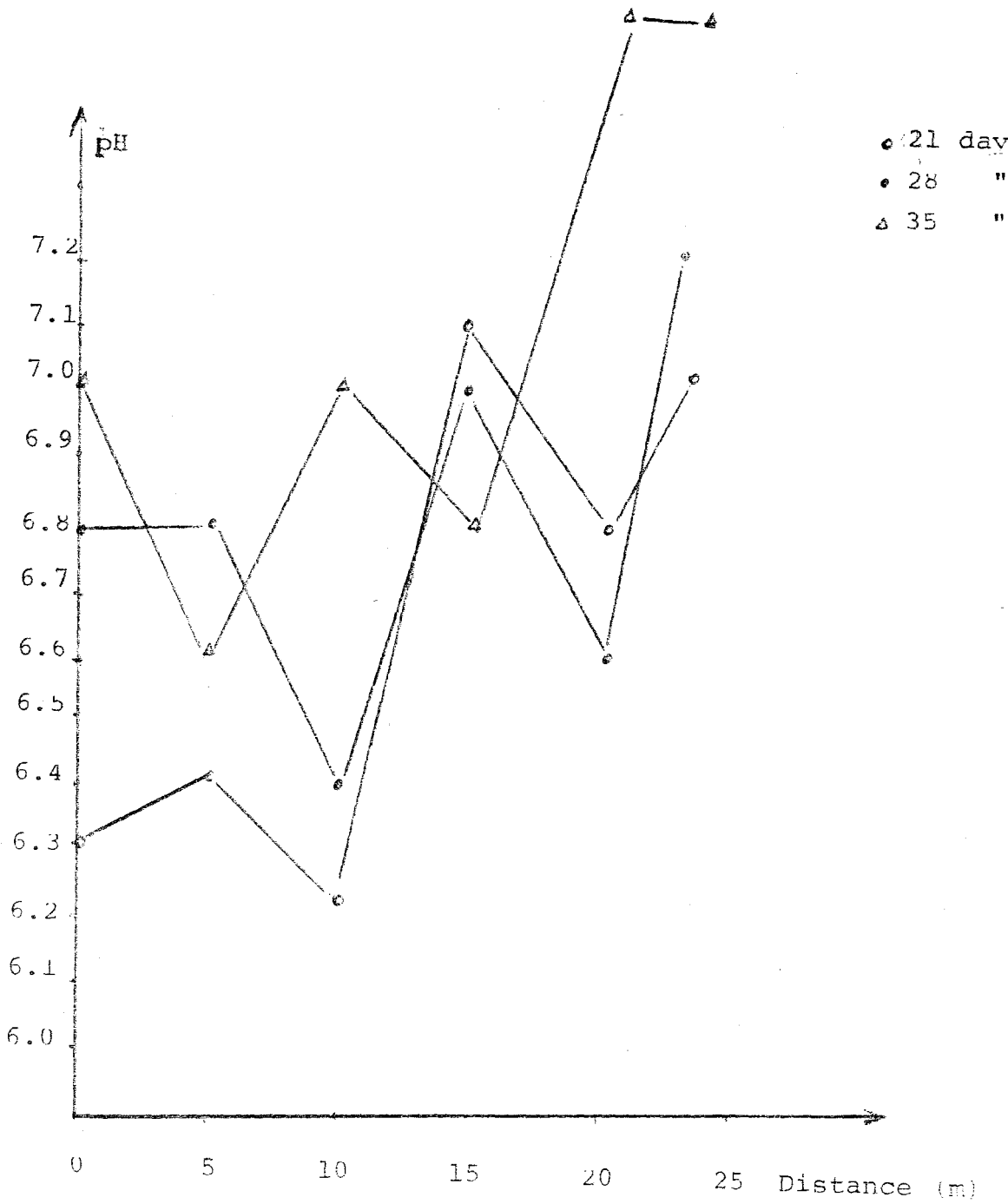

Figure 56 : Variation of pH with Distance in the Channel Full with Gravel

Figures 57 and 58 show the change of coliform with distance. These figures show that the removal of coliform decreases with increasing distance in the sand bed.

Figures 59 and 60 show the change of coliform with distance. The amount of coliform decrease with increasing distance in the gravel bed.

3.2 CROP PRODUCTIVITY

3.2.1 Procedure

This part of the study has been performed at Faculty of Forestry of Istanbul University. Its aim was to examine the crop productivity of the media through which wastewater has been disposed. To realize this

- i. Seven large boxes (1.00x1.00x0.20 m) shown in Figure 61 and seven small boxes (0.50x0.50x0.20 m) shown in Figure 62. The large boxes were divided into four parts as shown in Figure 63.
- ii. Media used in the land disposal study performed at Boğaziçi University was mixed with sandy soil which was taken out of 3 m depth from soil in Faculty of Forest of Istanbul University at Bahçeköy. This soil has been selected because it does not contain any nutrients and other growing factors (like hormones, vitamins, etc.). The composition of the mixtures used are given in Table 7. The mixtures prepared were placed in set of a big and a small box. The small box was used as a blank.

After the boxes were filled with the above mentioned mixtures, a small plant known as "Kadife Çiçeği" was planted.

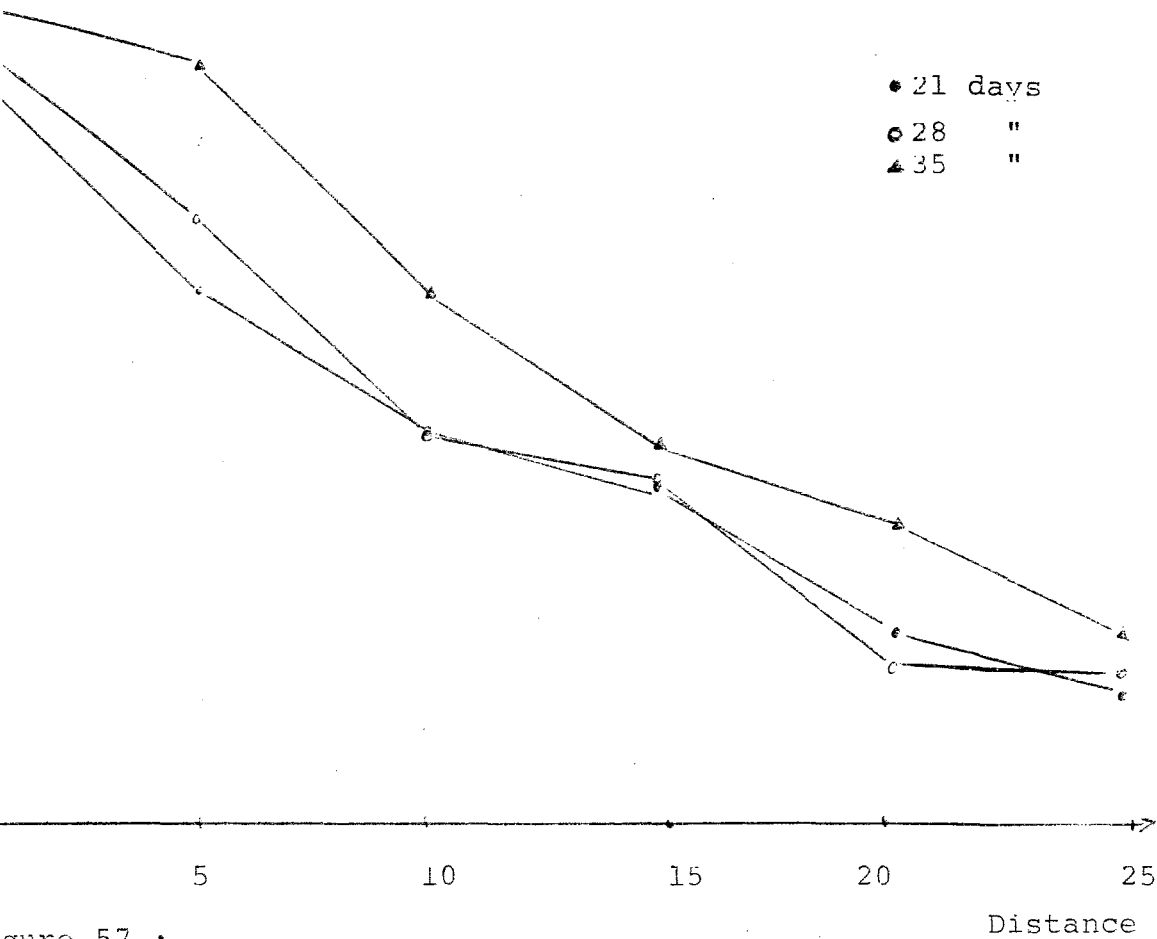

Figure 57 : Variation of Total Coliform with Distance in the Channel Full with Sand

Removal Efficiency of Coliforms %

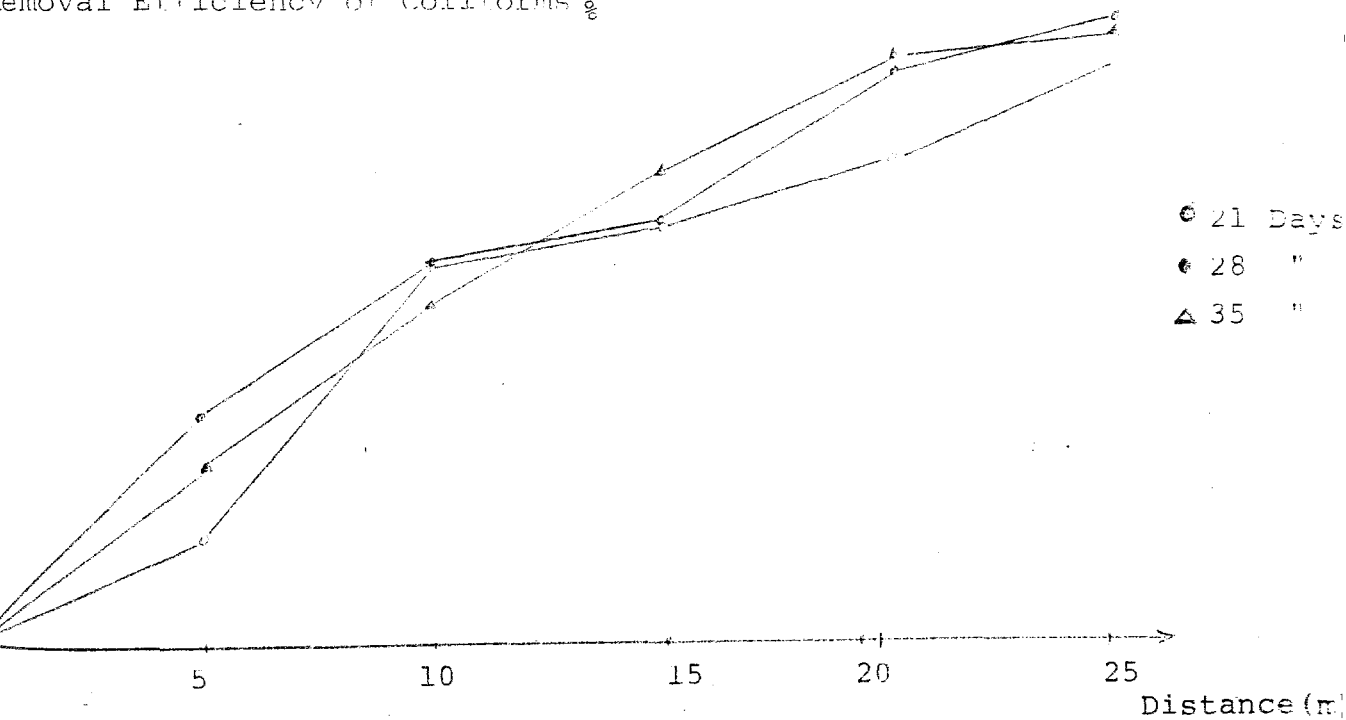

Figure 58 : Removal Efficiency of Coliform with Distance in Sand Bed

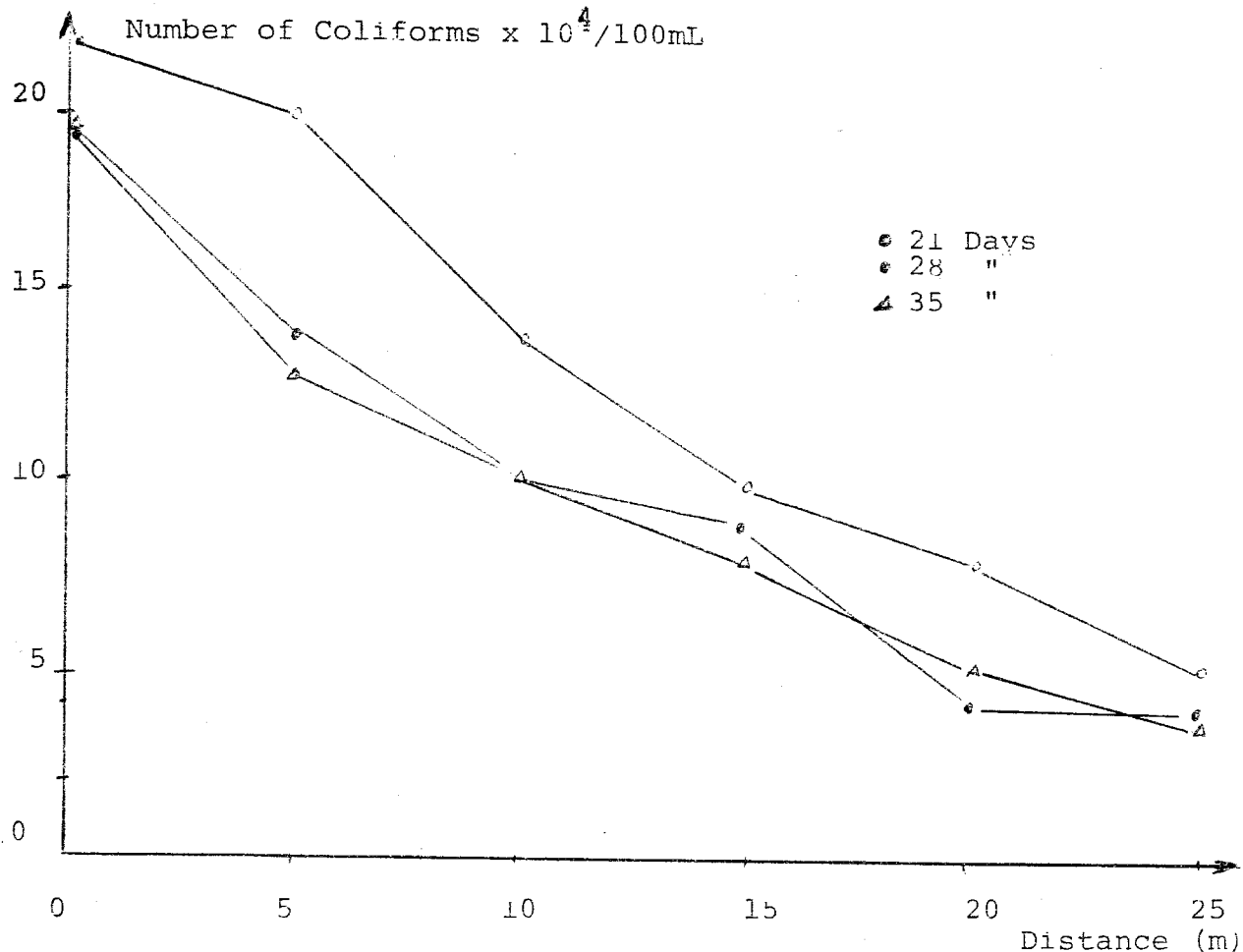

Figure 59 : The variation of Number of Coliform with Distance in the Channel Full with Gravel

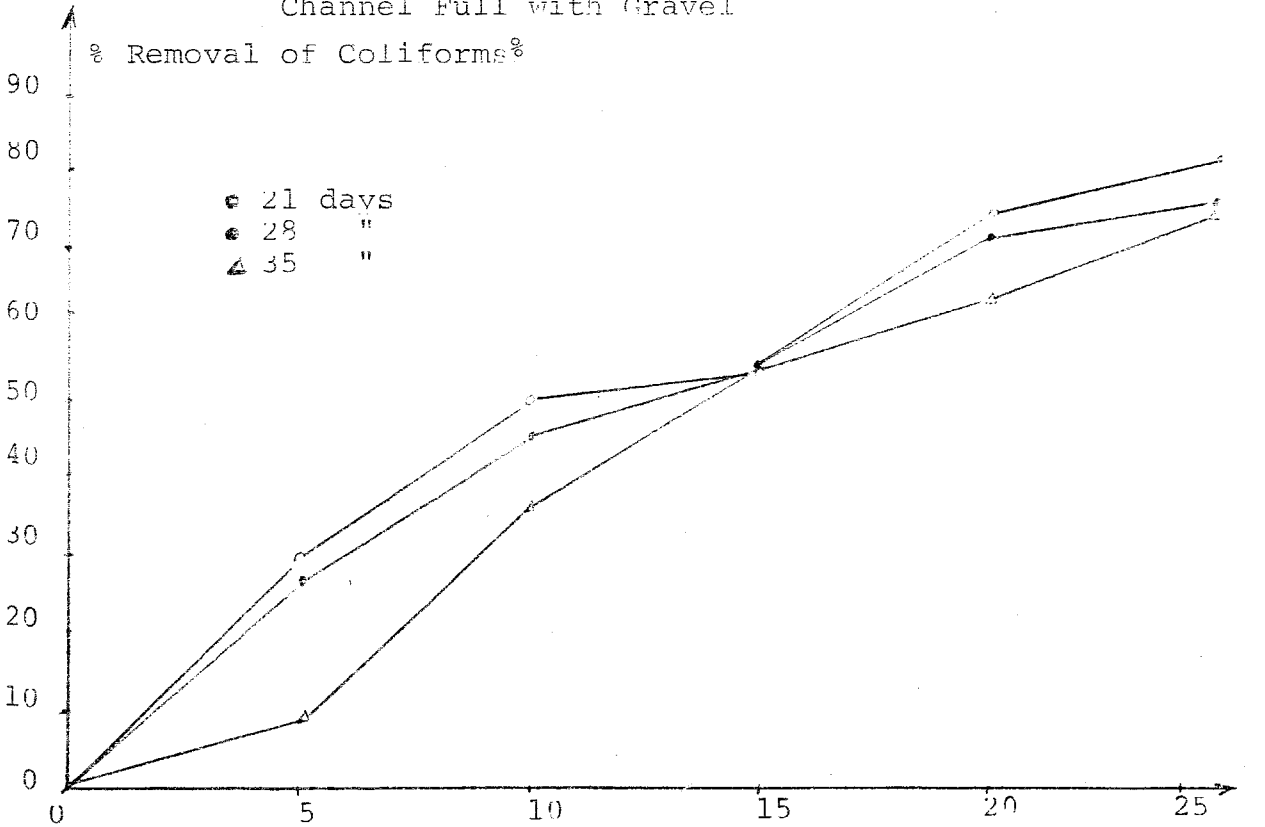

Figure 60 : The Removal Efficiency of Coliform with Distance in the Channel Full with Gravel

The prepared boxes were located in the east-west direction.

TABLE 7 - Plantation Experimental Sets

Set Number	Mixing Materials	Mixing Percent	Plant number in each set
1	Sand consist of nutrients	20	6x4
	Sandy soil	80	
2	Sand consist of nutrients	40	6x4
	Sandy soil	60	
3	Sand consist of nutrients	60	6x4
	Sandy soil	40	
4	Sand consist of nutrients	80	6x4
	Sandy soil	20	
5	Sand consist of nutrients	100	6x4
	Sandy soil	0.00	
6	Sand consist of nutrients	0.00	6x4
	Sandy soil	100	
7	Normal soil with fertilizers	100	6x4

Every day the plants were watered. This was made paying attention to the following factors.

- i. Water should be just absorbed by the soil and not penetrate from the box to the ground.
- ii. All parts of the soil should be wetted equally.

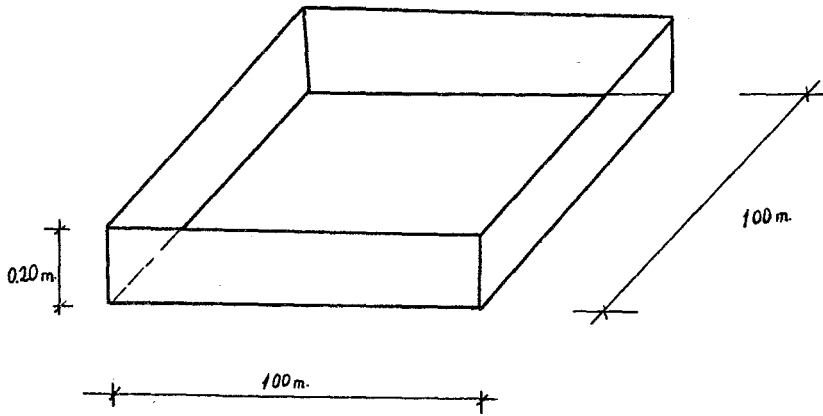

Figure 61 : Large Box

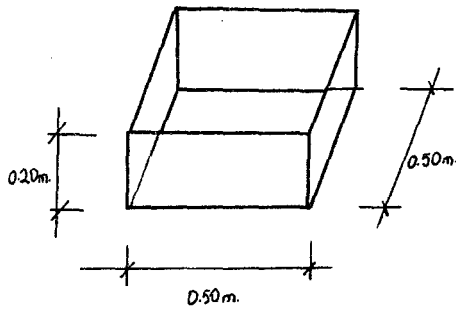

Figure 62 : Small Box

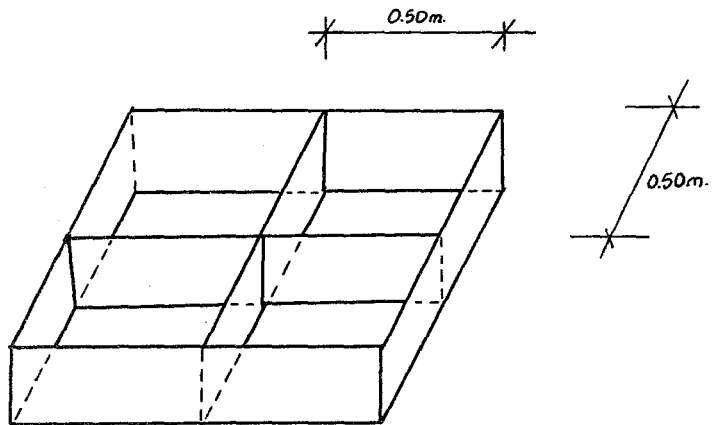

Figure 63 : Divided Box

iii. The plants were observed daily measuring.

- a) The length of the stem of each plant
- b) Length of leaves
- c) Diameter of body of plant
- d) Bud production time
- e) Blooming time
- f) Diameter of flower.

At the end of the experiment, the plants were taken out of the soil and divided carefully into stem, leaf, root, flower. Then the following parameters were determined.

- wet weight of stem
- number of leaves
- wet weight of leaves
- length of leaves
- the area covered by the roots
- wet weight of the roots
- number of flowers
- diameter of flowers
- wet weight of flowers
- diameter of stem.

3.2.2 Results

a. Growth of the Stem

The relation between the type of the soil mixture and the growth of stem is shown in Figures 64, 65, 66 and 67.

As can be seen in these graphs, the best result for the growth of the stem was obtained with a mixture containing 80% of the land disposal media. When the graph is examined the following observations can be made,

- i. The stem growth was negatively affected when only land disposal media was used. The reason of that may be that media settles and fills all the voids in the soil leaving no place for root growth. As a result of this, the roots of the plants are crushed.
- ii. The effect of the composition of the soil on the diameter of the flowers. As the percent of the land disposal material in the mixture increased better results were obtained in the flowering of the plants. This relation between flower diameter and mixture of soil is shown in Appendices B.2.3 and B.2.4 and in Figures 68, 69 and 70.
- iii. Effects of the land disposal material and soil mixture to leaf growth could not be observed, because after measuring the bottom leaves other leaves grew on the stem masking the measured bottom leaf and prevented sunlight from reaching the lower parts of the plant. Since sunlight is an important factor affecting growth, the effect of the mixture on leaf growth could not be obtained.
- iv. The variation of diameters of plants with respect to different mixtures and time is shown in Appendix B.2.2 and Figures 71, 72 and 73.

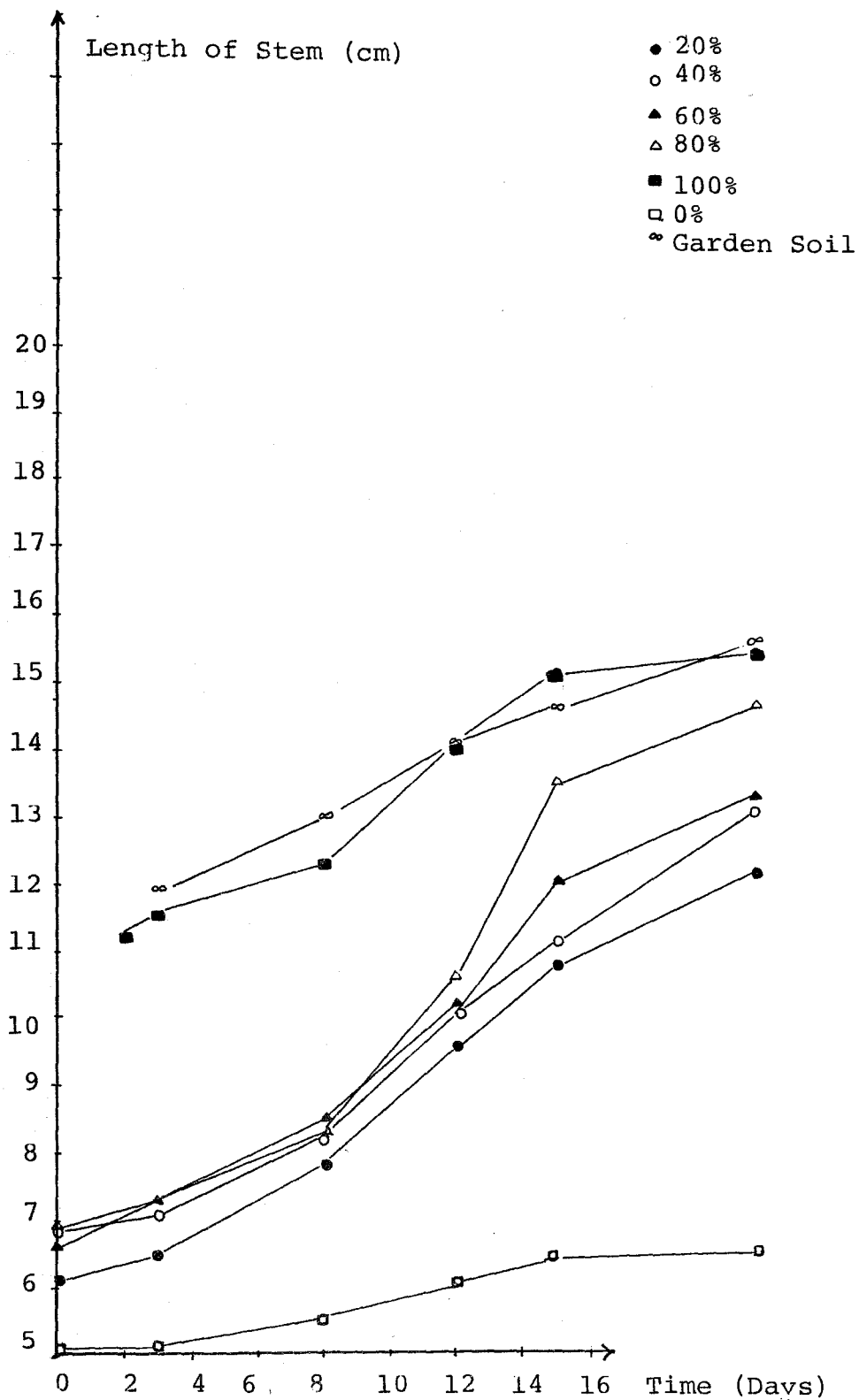

Figure 64 : Relation Between the Crop Growth and Time

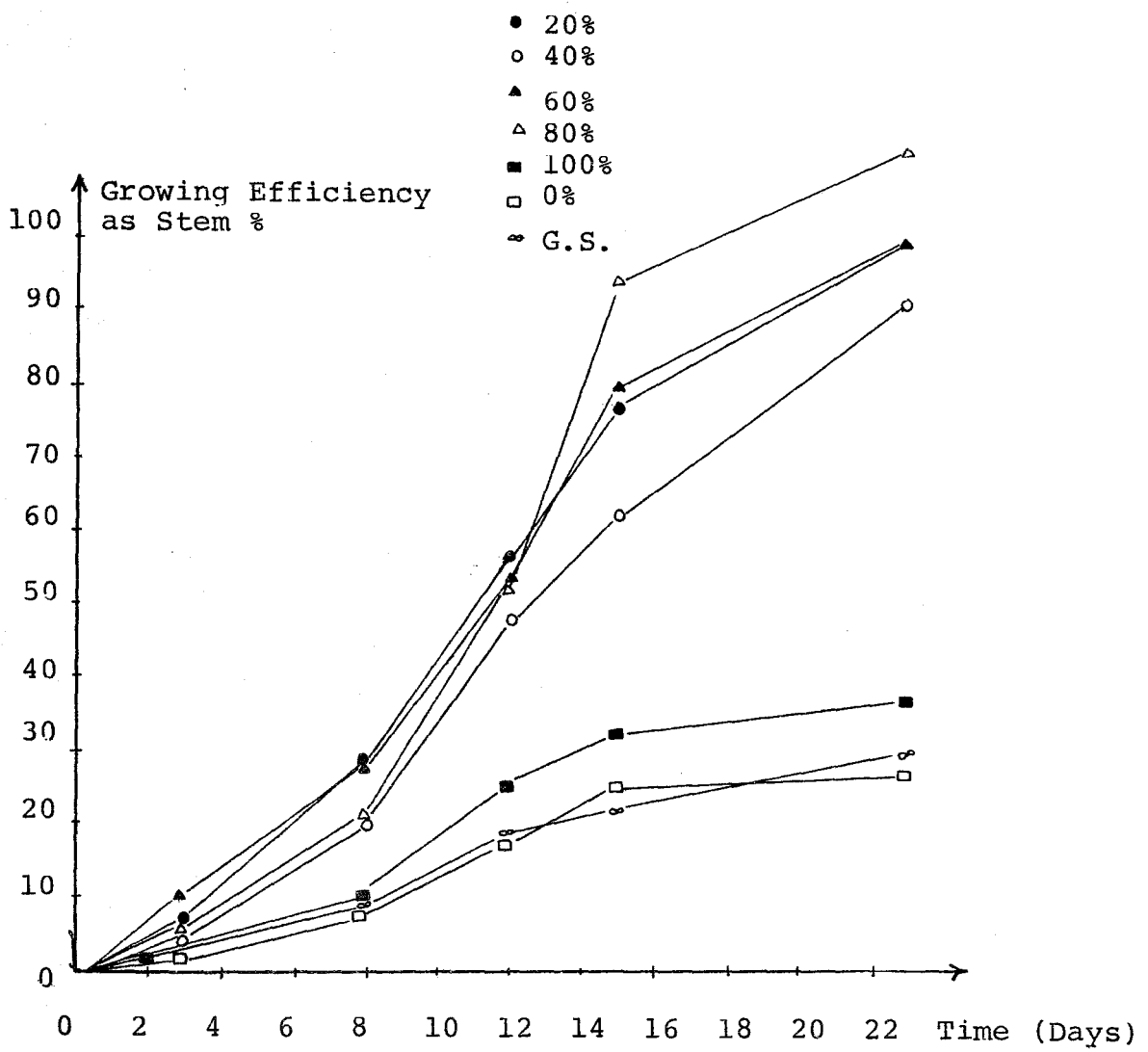

Figure 65 : Growing Efficiency of Stem with Time

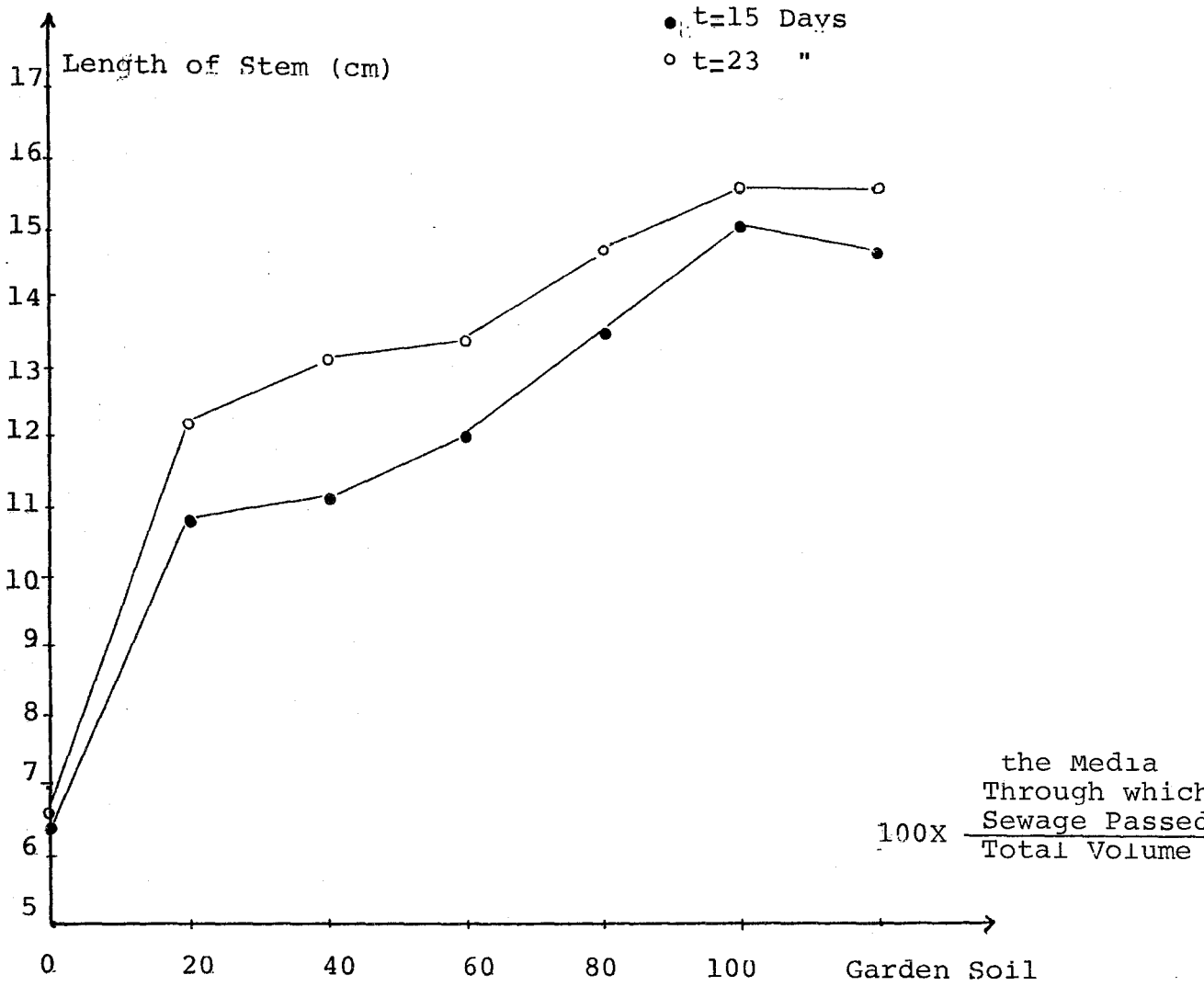

Figure 66 : Relation Between Crop Growth and Composition of the Soil



Figure 67 : The Plantation



Figure 68 : Variation of Pl...

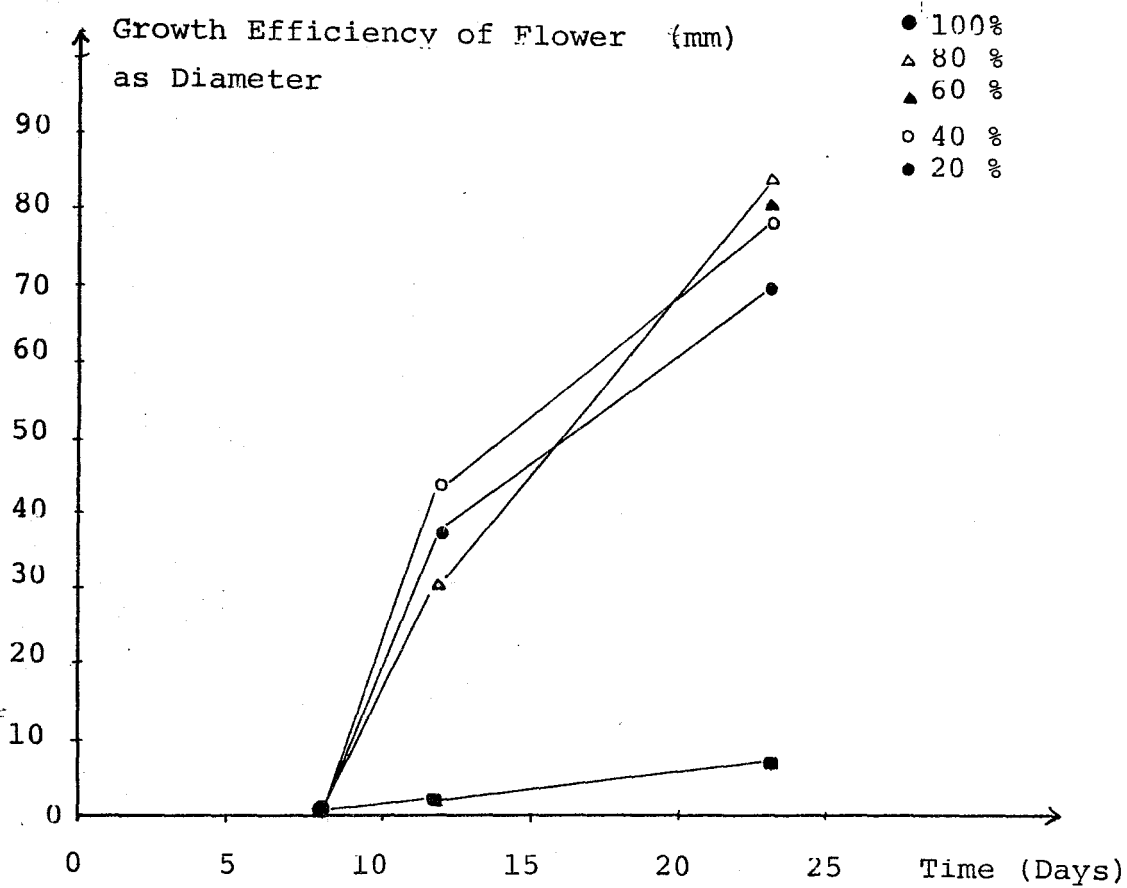

Figure 68 : Variation of Flower Diameter with Time

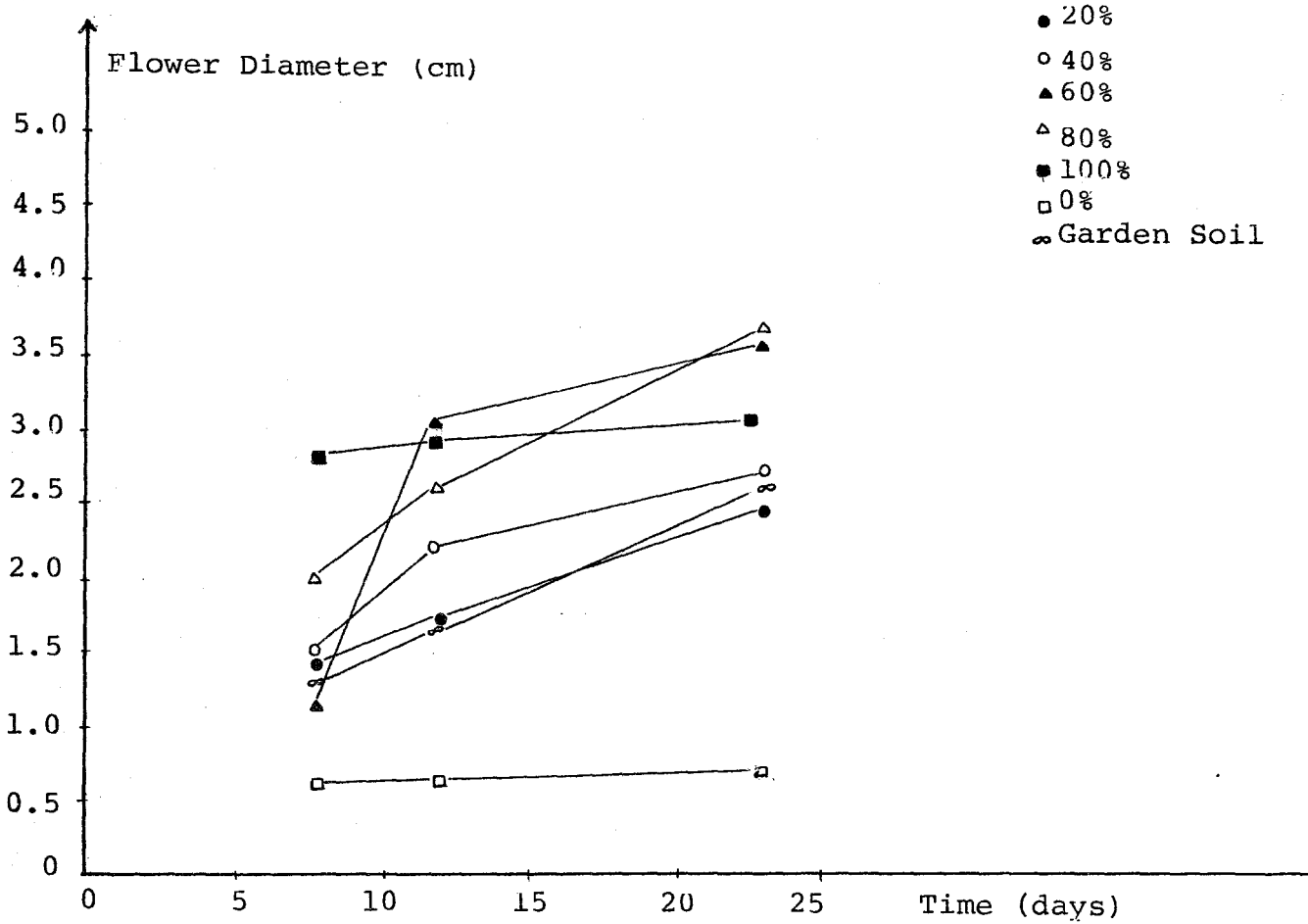

Figure 69 : Variation of the Diameter of Flower with Respect to Time



Figure 70 : Flowering Efficiency According to Composition of Mixture

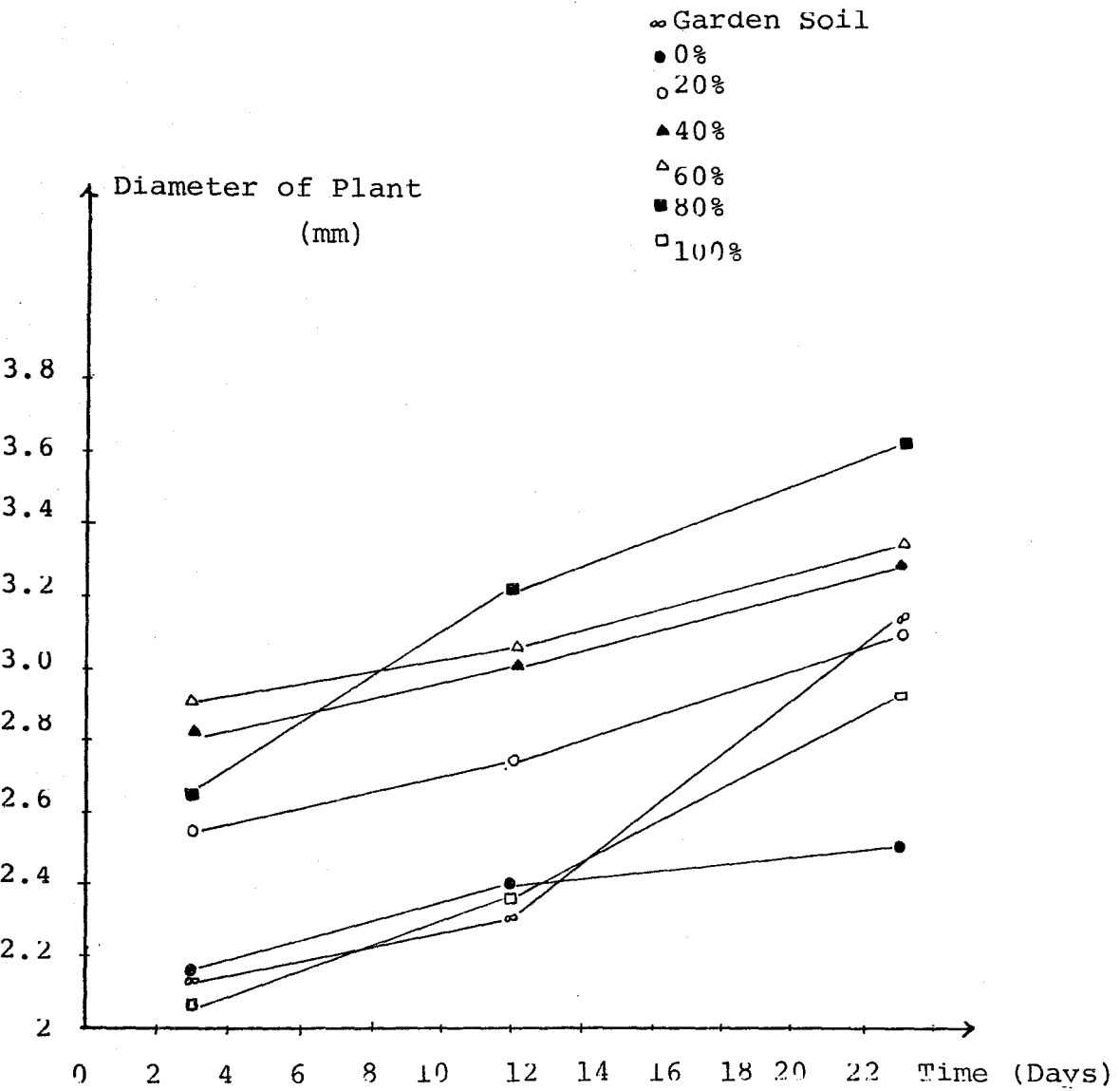

Figure 71 : Variation of the growth of the Plant Diameter with Time



Figure 72 : Variation of Plant Diameter with Respect to Composition of Mixture

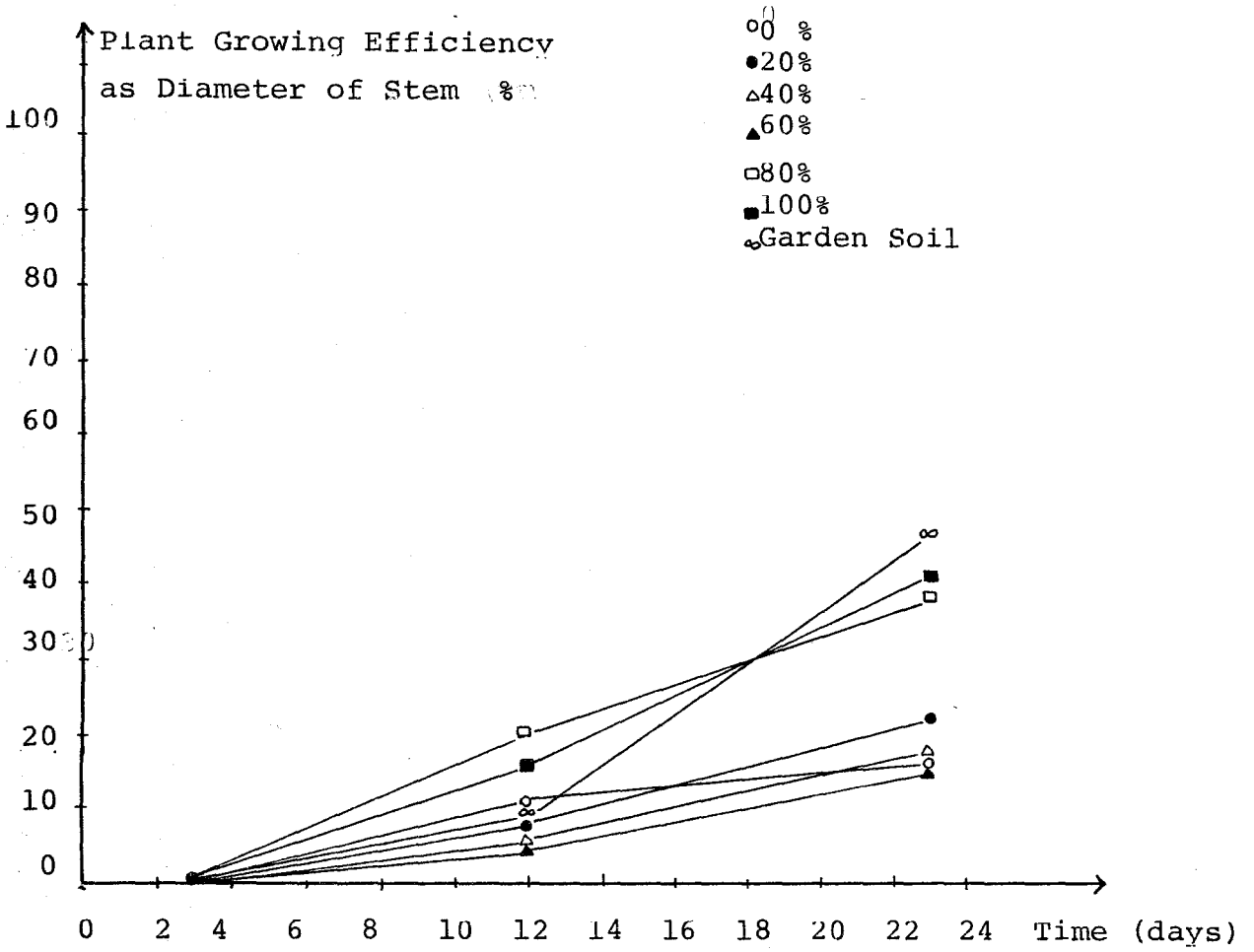

Figure 73 : Variation of Growing Efficiency of Plant with Time



Figure 74 : Relation between Root Length with Composition of Mixing

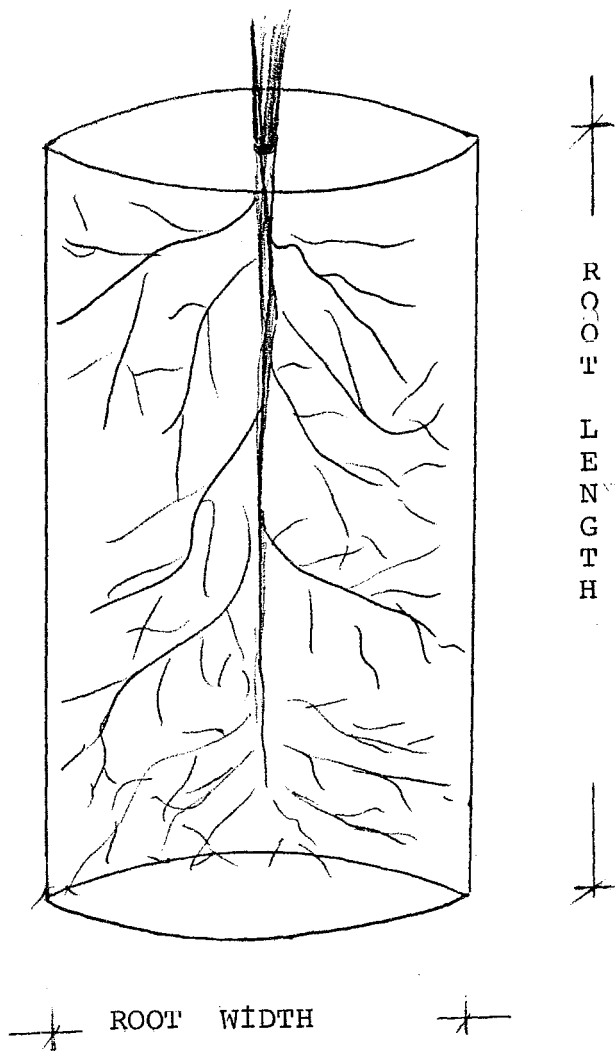

Figure 75 : Root Volume = Root length x Root width

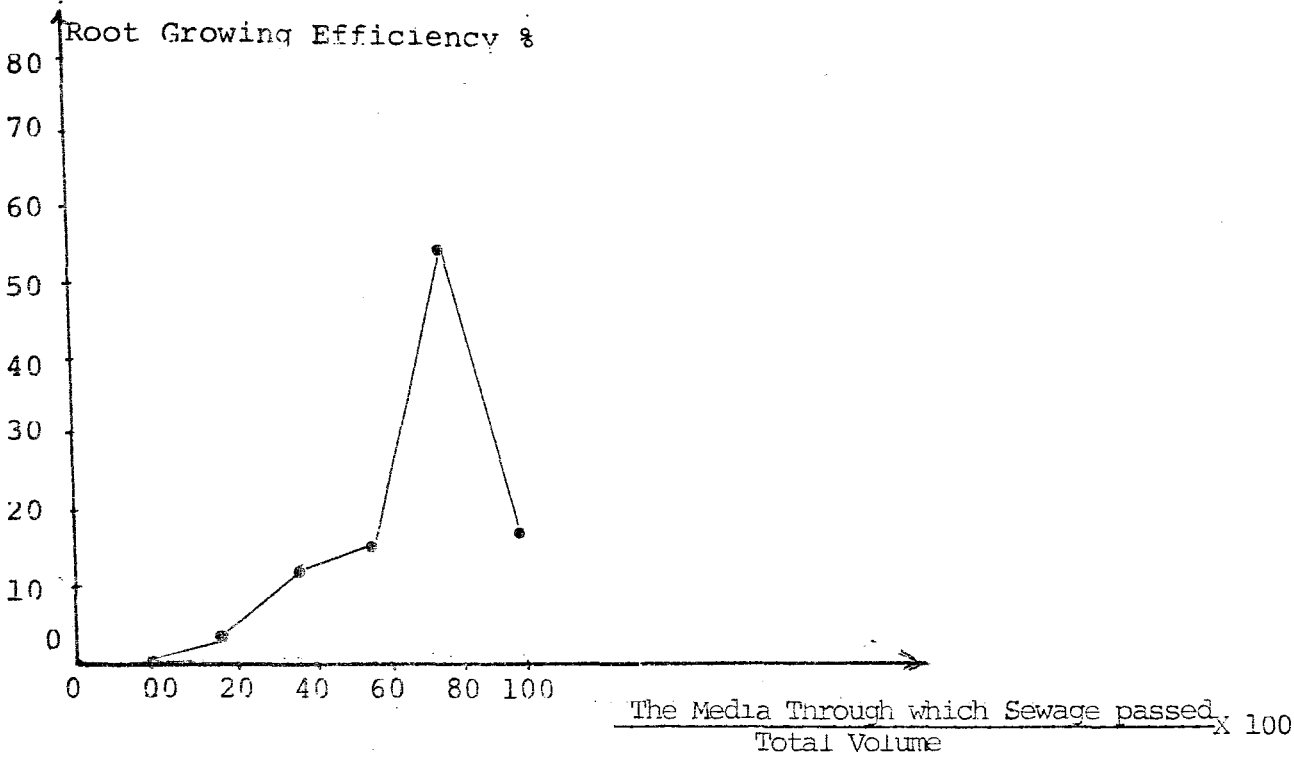

Figure 76 : Variation of Root Growth Efficiency with Respect to Composition of Mixture

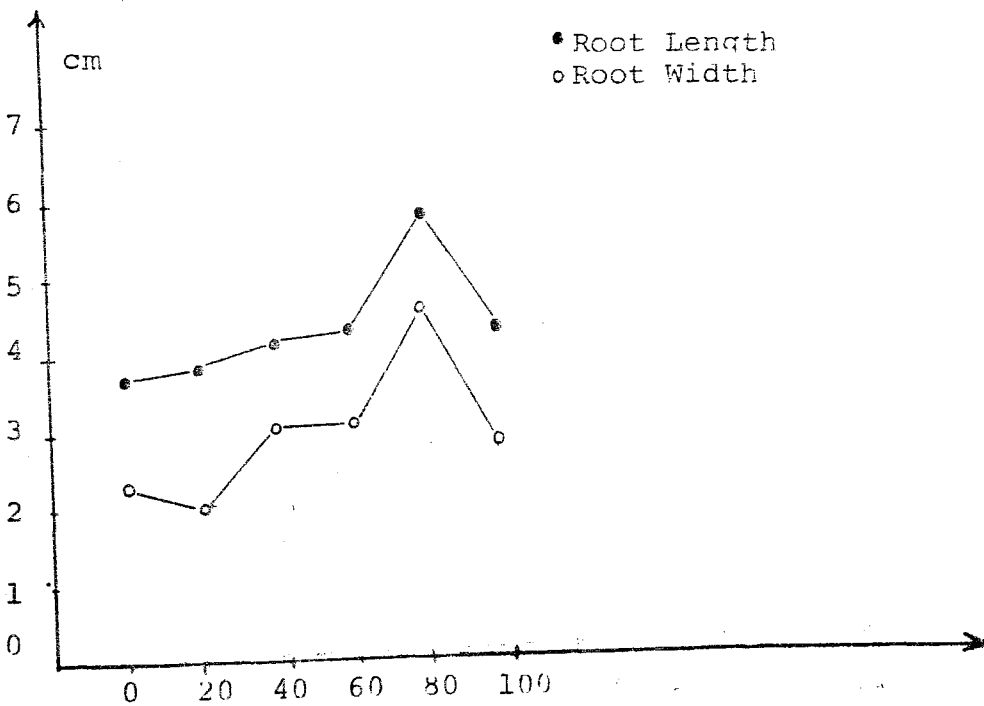

Figure 77 : Variation of the Root Length, Root Width with Respect to the composition of mixture

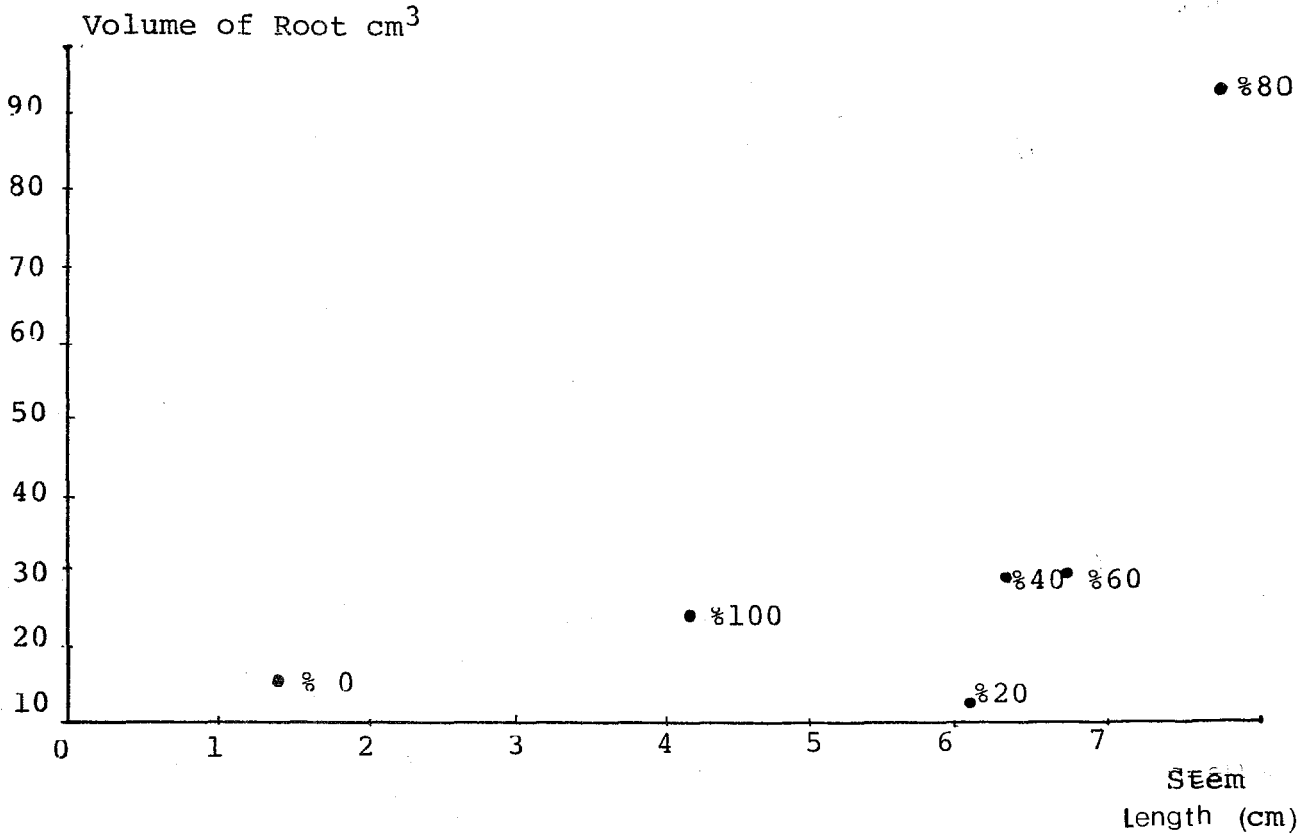

Figure 78 :Variation of root volume with respect to stem length

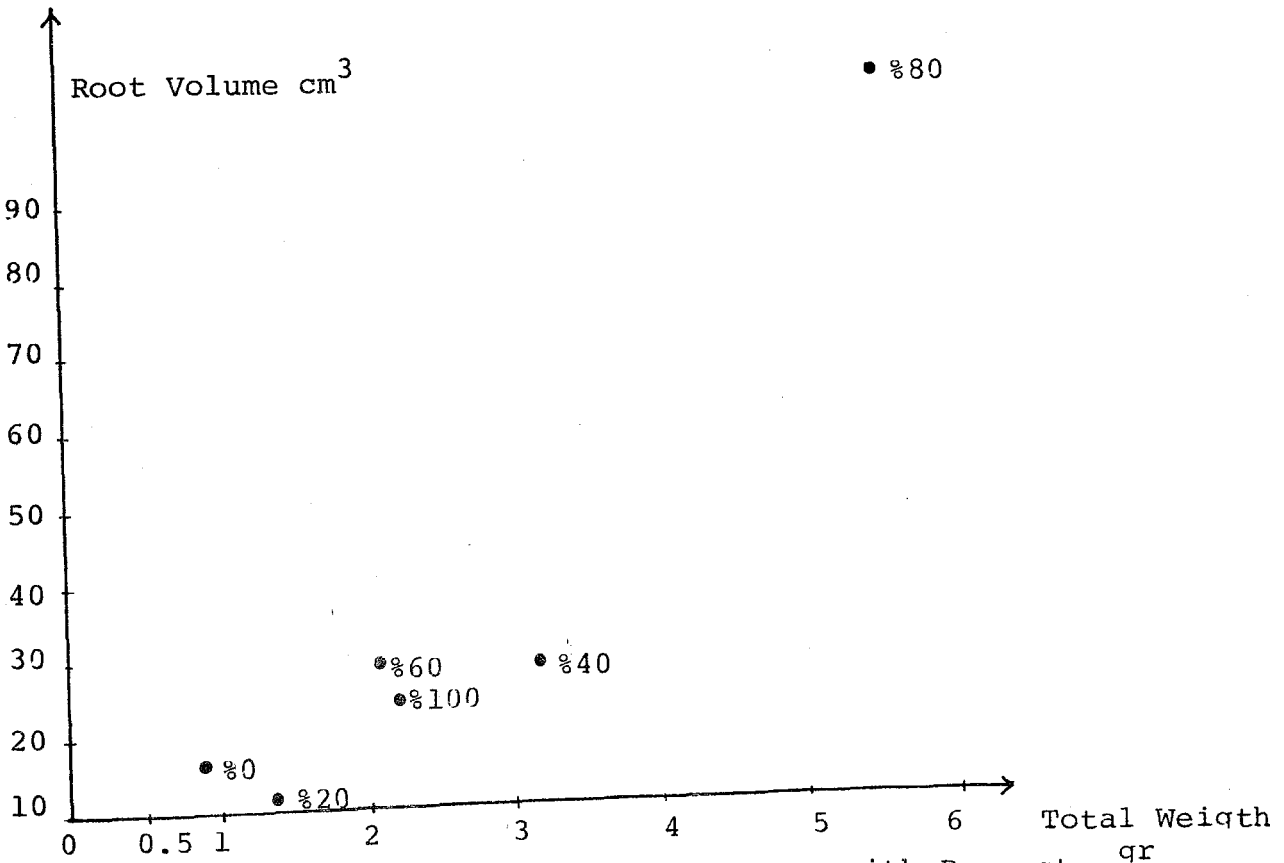

Figure 79 : Variation of the Root Volume with Respect to Total Weight of Plant

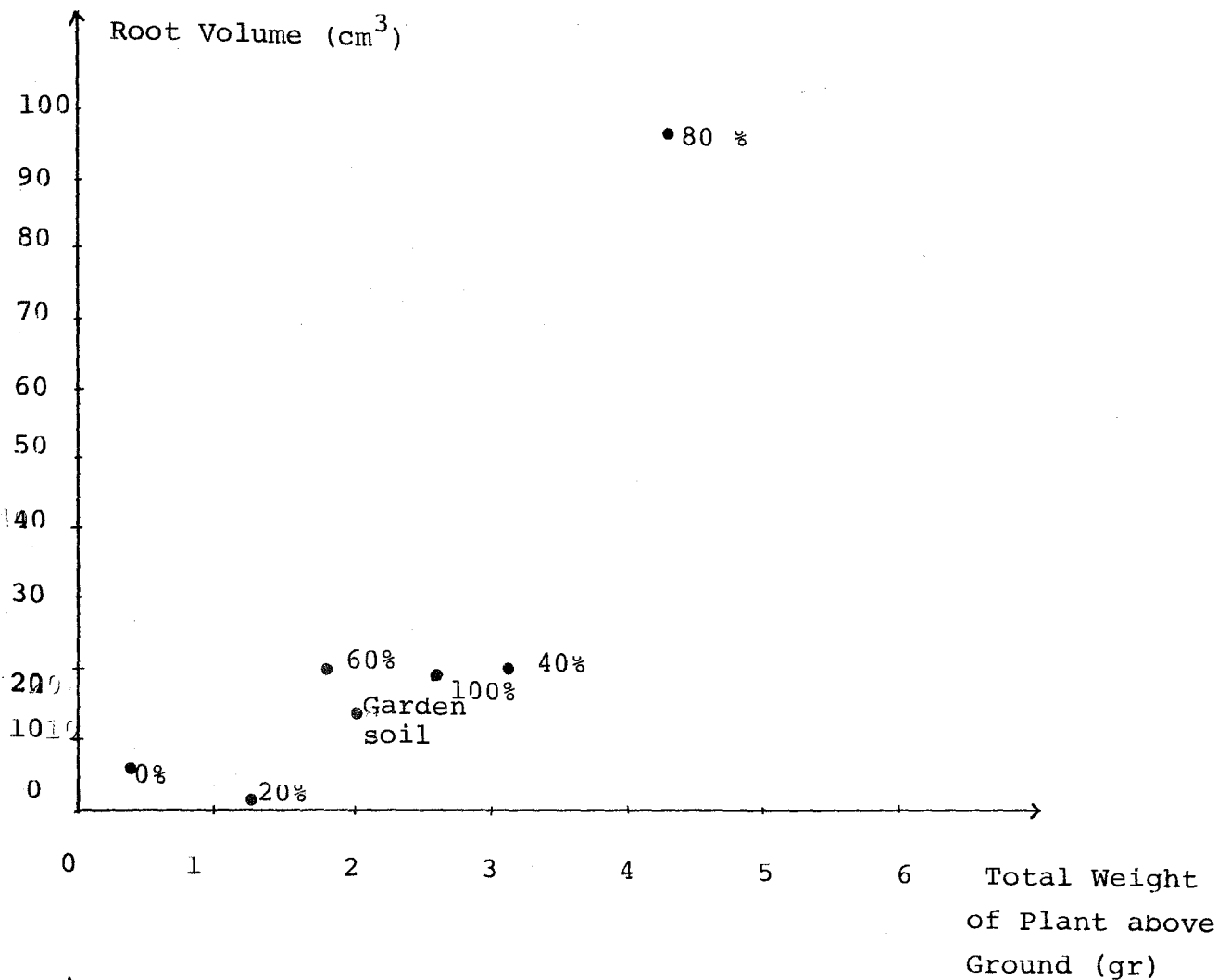

Figure 80 : Variation of the Root Volume with Respect to the Total Weight of the Plant above the Ground

Note: Figure ; 78,79 and 80 related to % indicates the ratio of $\frac{\text{The Media Through Which Sewage Passed}}{\text{Total Volume}} \times 10$

Observing these graphs, it can be seen that the best results were obtained with mixtures of 80% and 100% land disposal material. These mixtures affect the diameter of the plant in the same way as garden soil does. Mixtures of 40% and 20% land disposal material also gave the same results. When the mixture contained 60% of filter material, the diameter of the plant was affected negatively. For the time being, there is no explanation for this observation.

b. Weight of Plants

The weight of a plant is important for plantation. To examine this, ten plants were removed from every box. The root length and root width of each plant (Appendix B.2.5), total wet weight (Appendix B.2.6) and total dry weight (Appendix B.2.7) were measured.

To obtain the dry weight, every plant was separated into its stem, leaf, flower, and root. Each part was then placed separately into the oven for 1 hour at a temperature of 65°C. Weights were measured after cooling to room temperature and then the total dry weight of each plant was calculated.

The variation of root length and root width of plants is shown in Appendix B.2.5. According to these figures a mixture with 80% of land disposal material gives the best result.

In the soil with 100% land disposal material while the nutrients could be held, water run off. Also, lack of sufficient porosity prevented root growth of plants.

Another observation was the relation between the development of roots and stems. Plants with well developed roots also had well developed stems (Figure 74).

c. Root Volume

In order to have a better idea about the total weight of a plant the root volume of the plant was calculated (Appendix B.2.8). The root type was assumed as cylindrical shown as in Figure 75. These values correspond to total dry weights, total dry weight above ground and lengths of stems and their relations to each other are shown in Figures 76, 77 and Appendix B.2.8.

The volume of root, stem length of the plant increase, as the percent of the filter material in mixture increases up to 80% land disposal mixture. Mixture with 40% and 60% land disposal soil almost gave the same results and 80% of it gave the best result (Figures 78, 79, 80).

IV. DISCUSSION AND CONCLUSION

The results obtained in this study are a good indication that wastewater disposal on land is an efficient method for wastewater treatment. Although the technique used is very simple, removal efficiency similar to those obtained in conventional treatment methods can be obtained.

Another characteristic which makes this process advantageous is the increase of crop yield of the soil as indicated by results obtained in the present study as well as in the study of Baysal (1984)

The land treatment technique furthermore is a technique which needs minimum maintenance and operational care. Because of these factors, it is believed that land disposal is an advantageous technique for developing countries and is strongly recommended for the rural areas of Turkey.

These conclusions are verified by the following results obtained in the study: Chemical Oxygen Demand removal efficiency reached 76% in sand bed, 60% in gravel bed, Nitrogen removal efficiency reached 70% in sand bed, 57% in gravel bed for 35 days, removal efficiency of Phosphorus reached 77% in sand bed, 64% in gravel bed for 35 days.

Also it is indicated that the media used for the wastewater purification when used for agricultural purposes has a positive effect on the crop productivity.

V. RECOMMENDATION FOR FUTURE STUDIES

The following subjects are recommended to be investigated in future studies:

- Effect of variation of filter media and flowrate on pollutant removal efficiency.
- Type of plantation which can grow with increased yield on the used filter media.
- Amount of nutrients and other pollutants which remain in the filter media after growing different types of crops.
- Variation in the ground water quality, if any, in areas used for land disposal and crop growth.

REFERENCES

- Bernathy, A.R., Zirchky, J., Borup, M.B., "Land application of wastewater", Journal Water Pollution Control Federation, V-56 U.S.A., June 1984
- Receivala, S.J., Wastewater Treatment and Disposal, Marcel Deccer Inc. NewYork, 1981.
- Asano, T., Smith, G.r., Tchobanoglous, G., "Treatment and reclaimed water Characteristics", in Pettygrove, G.S. and Asano, T. (eds). Irrigation with reclaimed municipal wastewater. A guidance manual. Department of Land, Air and Water Resources University of California, July, 1984, R.N. 84-1.
- Baysal, A., Wastewater treatment by land disposal on sandy ground, Thesis Boğaziçi University, Istanbul, 1984.
- Goodbent, F.E., et al , "Treatment and reclaimed water charecteristics" in Pettygrove, G.S. and Asano, T. (eds). Irrigation with reclaimed municipal wastewater .A guidance manual. Department of Land, Air and Water Resources University of California, July, 1984, r.n. 84-1
- Goodrites, R.W., "Treatment and reclaimed water characteristics" in Pettygrove, G.S. and Asano, T., (eds) Irrigation with reclaimed municipal wastewater. A guidance manual. Department of Land, Air and Water Resources University of California, July, 1984. R.N. 84-1
- Wesner, R.L., Wesner, G.M., Handbook of Advantages wastewater treatment, 2nd ed., Van nostrand Reinhold Company, NewYork, 1978.
- Yurri, K., Baysal, A., Esen, "Wastewater Disposal on Land an appropriate technology for Developing Countries" in Envitek A.Ş. Enviromental Management for Developing Countries, Milliyet Yayın A.Ş., Istanbul, 1984

- nis, W.W., Avers, S.R. "Treatment and Reclaimed Water Characteristics",
in Pettygrove, G., Asano, T., (eds) Irrigation with
Reclaimed municipal Wastewater. A guidance manual,
California, July, 1984, R.N. 84-1
- , Process Design Manual for Land Treatment of Municipal Waste-
water, U.S. Environmental Agency, U.S. Department of Agriculture
, Cincinnati, October, 1977
- , Environmental Pollution Control Alternative Municipal Wastewater
U.S. Environmental Protection Agency, Cincinnati, 1979
- ir, C.N., Gayer, J.C., Water Supply and Waste Disposal, John Wiley and
Sons Inc., New York, 1958.
- ir, C.N., Gayer, J.C., Okun, D.A. Water and Wastewater Engineering, Vol. 2.
Wiley International Edition, New York, 1968
- rick, J.A. "Land application odor study" Journal of Water Pollution
Control Federation, Vol. 56 N-3, March, 1984
- rnandez, J.W. "Criteria for Irrigation With Industrial Wastes", in Curi,
K., Kocasoy, G., Sebüktekin, U., (eds) Preprints of Treatment
and Disposal of Liquid and Solid Industrial Wastes, Vol. 1
111. Turkish German Environmental Engineering Symposium
Civil Engineering Department, Boğaziçi University, Istanbul
Turkey, 1979.
- casoy, G., Çöllerşen Dünva ve Türkiye Örneđi, 7. sempozyum, Atatürk Üni-
versitesi Çevre Sorunları Araştırma Merkezi, Erzurum, May.
1985
- tcalf and Eddy Inc., Wastewater Engineering Collection, Treatment, Dispo-
sal and Reuse, Mc. Graw -Hill Publishing Company
Ltd. 2nd edition, New York, 1972
- tcalf and Eddy Inc., Wastewater Engineering Treatment, Disposal and Reuse
Mc. Graw -Hill Publishing Company Ltd., 2nd Edition
New Delhi, 1979.

- s, R.L., Asano, t., Land Treatment and Disposal of Municipal and Industrial Wastewater, Ann Arbor Science Publishers Inc., Michigan, 1976.
- ver, C.N., Mc. Cartv., L.P., Chemistry for Sanitary Engineers 2nd edition
Mc. Graw-Hill Inc., Kogakuska, Tokyo, Japan, 1967
- lian R.H., Cohn, M.M., Baxter, S.S., "Survey of Facilities using Land Application of wastewater", U.S. Environmental protection agency, Washington, 1973
- ndtard Methods for the Examination of Water and Wastewater, 15th edition
merican Public Health Organization, American Water works Association
Water Pollution Control Federation, New York, 1981
- ne, J.E., "Soil as a treatment medium", Land Application of Wastes an education Program, Cornell University, May., 1976.
- ilind, P.A., Environmental Pollution and Control ; Ann Arbor Science Publishers Inc., Michigan, 1978.

APPENDIX A

DETAILS of THE CHANNELS and THE POROUS MEDIA

Number of the channels :.....2
 The total volume of channels: $0.385 \times 0.750 \times 24.66 = 7.12 \text{ m}^3$
 Volume of the channel filled with sand :
 $0.35 \times 0.385 \times 21 = \dots 2.83 \text{ m}^3$
 Volume of the channel filled with gravel :
 $0.40 \times 0.385 \times 21 = \dots 3.234 \text{ m}^3$
 The total surface area of channels : $0.385 \times 24.66 = 9.50 \text{ m}^2$
 Surface area of channel filled with sand :
 $0.385 \times 21 = \dots 8.09 \text{ m}^2$
 Surface area of the channel filled with gravel :
 $0.385 \times 21 = \dots 8.09 \text{ m}^2$
 The height of sand :.....0.35m
 The height of gravel :.....0.40m
 The porosity of sand :.....40 %
 The porosity of gravel :.....43 %

The sieve analysis of sand and gravel samples are shown in Table A.1 , A.2 , A.3 and A.4

TABLE A.1. SIEVE ANALYSIS OF GRAVEL SAMPLES TAKEN FROM 5 METERS

Sample Weight 1000gr. (drv)

Sieve Number	Hole Diameter mm	Weight of sample retained on the sieve (gr)	Weight of sample passed to the sieve	P_i %	$100-P_i$
3/6"	12.7	0	1000	0	100
4.3/16"	4.76	278	722	27.8	72.2
10	2.00	320	402	32	40.2
16	1.19	182	220	18.2	22
30	0.59	176	44	17.6	4.4
40	0.42	10.4	33.6	2.04	3.36
60	0.21	20	13.6	2	1.36
100	0.149	13.6	--	1.36	-

TABLE A.2. SIEVE ANALYSIS OF GRAVEL SAMPLES TAKEN FROM 20 METERS

3/6"	12.7	0	1000	0	100
4.3/16"	4.76	322	678	32.2	67.8
10	2.00	468	210	46.8	21
16	1.19	100	110	10	11
30	0.59	50	60	5	6
40	0.42	38	22	3.8	2.2
60	0.21	13	9	1.3	0.9
100	0.14	9	-	0.9	-

TABLE A. 3. SIEVE ANALYSIS OF SAND SAMPLES TAKEN FROM 5 METERS
Sample Weight 1000 gr. (Dry)

Sieve Number	Hole Number mm	Weight of sample retained on the Sieve (gr)	Weight of sample Passed to the Sieve (gr)	$P_i\%$	$100-P_i$
3/8"	8	0	1000	100	0
4.3/16"	4.76	30	970	97	3
10	2	186	784	78.4	21.6
16	1.19	405	379	37.9	62.1
30	0.59	176	203	20.3	79.7
40	0.42	106	97	9.7	90.3
50	0.29	96.5	-	-	99.9

TABLE A. 4. SIEVE ANALYSIS OF SAND SAMPLES TAKEN FROM 20 METERS
Sample weight 1000 gr (Dry)

Sieve Number	Hole Number mm	Weight of sample retained on the Sieve (gr)	Weight of sample passed to the Sieve (gr)	P_i	$100-P_i$
3/8"	8	0	1000	100	0
4.3/16"	4.76	34	966	96.6	3.4
10	2	180	786	78.6	21.4
16	1.19	380	406	40.6	59.4
30	0.59	170	236	23.6	76.4
40	0.42	100	136	13.6	86.4
50	0.29	135	1	0.01	99.9

APPENDIX B

RESULTS OF EXPERIMENTS

B-1 WASTEWATER ANALYSIS RESULTS

B.1.1 Chemical oxygen demand (COD) (mg/L)

i) Samples taken from sand bed

Distance Time (days) \ (m)	0	5	10	15	20	25
0	554.36					238.60
5	480.73					153.83
11	485.63	407.60	373.90	310.80	155.40	145.70
16	460.26	409.60	363.60	308.30	257.70	145.70
18	520.40	447.50	411.10	343.50	166.50	161.30
21	535.33	455.00	447.00	342.60	160.60	133.80
25	484.93	407.30	281.30	242.50	203.70	155.20
28	620.66	521.35	465.50	384.80	173.80	148.90
32	580.00	493.00	440.80	365.40	156.60	133.40
35	420.00	361.20	306.60	252.00	105.00	94.50

ii) Samples taken from gravel bed

Distance Time (days) \ (m)	0	5	10	15	20	25
0	554.30					321.50
5	480.20					225.70
11	482.80	439.20	424.90	366.90	313.80	290.00
16	460.40	396.00	285.40	239.40	211.60	185.40
18	520.40	510.00	493.30	437.80	371.30	249.80
21	535.60	492.70	439.00	385.60	337.40	208.80
25	483.70	425.60	372.40	290.20	251.50	222.50
28	620.00	551.80	502.20	372.00	328.60	285.20
32	581.20	511.40	441.70	377.80	238.20	226.70
35	420.00	336.00	252.00	218.40	184.80	151.20

B.1.2. NITROGEN (N) (mg/L)

i) Samples taken from sand bed

Distance Time (days) (m)	0	5	10	15	20	25
0	15.65					8.13
5	16.45					4.94
11	18.24					8.57
16	22.40					8.74
18	24.50	24.01	19.60	14.70	11.76	8.06
21	19.60	19.20	16.07	12.15	10.20	7.30
25	14.40	-----	13.80	10.40	7.50	4.60
28	19.20	19.10	18.40	13.44	9.60	5.90
32	24.30	24.30	23.50	17.70	12.60	7.70
35	-	-	18.30	-	-	7.20

ii) Samples taken from gravel bed

Distance Time (Days) (m)	0	5	10	15	20	25
0	15.60					9.80
5	16.40					5.90
11	18.00					9.40
16	22.80					10.90
18	24.50			21.56	20.20	17.60
21	20.00	19.60	18.80	14.80	10.40	8.80
25	14.40		13.24	10.40	7.80	6.60
28	19.10	19.00		14.50	11.40	9.20
32	24.30	24.00	23.10	19.44	14.60	12.30
35	21.10		18.80		12.70	11.40

B.2.3. PHOSPHORUS (P) (mg/L)

i) Samples taken from sand bed

Distance Time (Days) (m)	0	5	10	15	20	25
0	4.00					1.00
5	5.00					1.00
11	6.80					1.20
16	4.00					1.30
18	6.50	6.50	6.00	5.40	2.50	1.70
21	6.00	6.00	5.60	4.80	3.20	2.00
25	5.50	5.00	4.80	3.50	2.00	1.30
28	5.00	5.00	4.80	3.50	3.20	2.50
32	4.50	4.50	4.00	3.80	2.60	2.00
35	4.60	4.50	4.00	3.60	3.00	1.60

ii) Samples taken from the gravel bed

Distance Time (Days) (m)	0	5	10	15	20	25
0	4.00					1.70
5	5.00	6.50	5.80		2.40	1.70
11	6.40					2.10
16	4.20					1.40
18	6.50		6.00	5.80	4.20	2.40
21	6.10	6.00	5.40	5.00	3.80	2.60
25	5.50	5.50	5.00	4.20	2.60	1.70
28	5.20	5.00	4.60	4.00	3.20	2.80
32	4.50	4.50	4.00	3.60	3.40	2.60
35	4.80	4.50	4.60	3.80	3.00	2.80

B.2.4. PH

i) Samples Taken from the Sand Bed

Distance Time (Days) (m)	0	5	10	15	20	25
0	6.80					7.10
5	7.20					7.80
11	6.50					6.70
18	7.10					7.40
21	6.40	6.60	6.40	7.00	7.00	6.80
25	6.30	6.50	6.40	6.80	6.60	6.60
28	6.80	6.90	6.60	7.00	7.10	7.20
32	7.50	6.80	7.40	7.20	6.90	7.50
35	6.80	6.80	7.20	7.00	7.20	7.40

ii) Samples taken from the Gravel Bed

Distance Time (Days) (m)	0	5	10	15	20	25
0	6.80					7.00
5	7.20					7.90
11	6.50					6.40
18	7.20					7.20
21	6.30	6.40	6.20	7.10	6.80	7.00
25	6.50	6.60	6.70	6.60	7.20	6.40
28	6.80	6.80	6.40	7.00	6.60	7.20
32	7.50	7.50	7.20	6.80	7.40	7.80
35	7.00	6.60	7.00	6.80	7.60	7.60

B.1.5. TOTAL SOLIDS DATA (TSD) (mg/L)

i) Samples Taken from the Sand Bed

Distance Time (Days) (m)	0	5	10	15	20	25
0	420					363
5	453					368
11	356					344
16	404					386
18	578		504			484
21						
25	564		498			473
28	508	499	483	475	464	448
32	724	702	698	654	663	648
35	532	532	524	516	510	496

ii) Samples taken from the Gravel Bed

Distance Time (Days) (m)	0	5	10	15	20	25
0	426					402
5	450					414
11	358					303
16	404					367
18	580		496			556
21						
25	573					564
28	478	477	464	460	468	452
32	694	693	682	686	672	678
35	535	530	525	494	498	483

B.1.6. COLIFORM NUMBER 10^5 /100ml

i) Samples taken from the Sand Bed

Distance Time (Days) (m)	0	5	10	15	20	25
0	0.8					0.34
5	1.0					0.60
11	1.2					0.56
16	1.4					0.84
18	1.4	1.4	1.2	1.00	0.62	0.56
21	1.6	1.2	0.8	0.68	0.56	0.42
25	1.8	1.8	1.6	0.66	0.50	0.48
28	2.1	1.9	1.6	1.00	0.82	0.50
32	2.8	2.6	2.0	1.8	1.4	0.82
35	2.4	2.2	2.0	1.6	0.9	0.42

ii) Samples taken from the Gravel Bed

Distance Time (Days) (m)	0	5	10	15	20	25
0	0.8					0.4
5	1.0					0.8
11	1.2					0.63
16	1.4					0.86
18	1.4	1.2	1.0	0.8	0.72	0.63
21	1.6	1.4	1.0			0.54
25	1.8	1.76	1.54			0.46
28	2.1	2.0	1.83	1.70	1.00	0.68
32	2.8	2.74			0.84	0.40
35	2.4	2.4	1.8	1.2	0.78	0.54

B.2. PLANTATION RESULTS

B.2.1. THE LENGTH OF STEM (cm)

No	Time (days)	0		3		8		12		15		23	
		\bar{x}	\bar{X}	\bar{x}	\bar{X}	\bar{x}	\bar{X}	\bar{x}	\bar{X}	\bar{x}	\bar{X}	\bar{x}	\bar{X}
1	a	6.03	6.08	6.23	6.49	7.40	7.84	8.45	9.55	10.00	10.81	11.87	12.17
	b	5.61		6.33		7.84		9.55		10.83		12.13	
	c	7.80		8.06		9.45		12.25		13.25		14.38	
	d	4.88		5.33		6.68		7.93		9.16		10.28	
2	a	8.40	6.8	7.43	7.1	8.06	8.19	11.42	10.09	12.25	11.12	13.73	13.10
	b	5.95		6.03		7.24		8.66		9.66		11.08	
	c	6.57		6.80		8.40		10.00		11.50		14.20	
	d	6.26		8.17		9.06		10.28		11.33		13.37	
3	a	6.3	6.66	6.7	7.33	8.64	8.51	11.17	10.23	12.83	11.96	15.50	13.40
	b	6.53		6.8		7.82		9.90		11.08		10.71	
	c	7.06		8.40		8.64		9.30		11.33		13.00	
	d	6.75		7.43		8.92		10.53		12.58		14.40	
4	a	7.62	6.9	8.33	7.32	9.04	8.35	13.07	10.58	13.83	13.48	16.00	14.70
	b	6.88		7.10		8.82		11.17		13.50		12.90	
	c	6.63		6.57		7.55		9.93		13.42		16.75	
	d	6.60		7.26		7.98		8.16		13.17		13.25	
5	a	11.13	11.33	11.33	11.52	12.01	12.34	14.13	14.10	15.58	15.10	15.60	15.54
	b	12.13		12.33		13.42		14.50		14.75		15.00	
	c	11.57		11.63		12.24		13.51		14.33		15.08	
	d	10.47		10.78		11.68		14.27		15.75		16.50	
6	a	5.33	5.14	5.38	5.23	5.84	5.55	6.22	6.03	6.48	6.45	6.50	6.53
	b	5.67		5.80		6.24		6.45		6.74		6.70	
	c	4.23		4.38		4.58		5.63		6.36		6.60	
	d	5.32		5.36		5.52		5.86		6.22		6.30	
7	a			12.28	11.99	13.04	12.98	13.85	14.22	13.40	14.68	14.48	15.61
	b			11.83		12.24		14.39		15.92		16.27	
	c			12.14		13.60		14.64		15.14		16.44	
	d			11.71		13.08		14.00		14.24		15.35	

B.2.2. DIAMETER OF PLANT (mm)

Time (d)	No	3		12		23	
		\bar{x}	\bar{X}	\bar{x}	\bar{X}	\bar{x}	\bar{X}
1	a	2.67	2.55	2.71	2.75	2.93	3.10
	b	2.43		2.73		3.17	
	c	2.53		2.73		3.33	
	d	2.57		2.84		2.98	
2	a	2.73	2.82	2.95	3.00	3.28	3.29
	b	2.63		2.76		3.07	
	c	2.83		3.10		3.36	
	d	3.07		3.22		3.44	
3	a	3.1	2.91	3.18	3.06	3.44	3.36
	b	2.93		3.00		3.33	
	c	2.8		2.77		2.98	
	d	2.8		3.28		3.50	
4	a	2.4	2.64	3.03	3.23	3.52	3.64
	b	2.41		3.22		3.65	
	c	2.83		3.37		3.79	
	d	2.9		3.29		3.58	
5	a	2.42	2.07	2.19	2.37	2.73	2.92
	b	2.00		2.36		2.85	
	c	1.54		2.59		2.75	
	d	2.34		2.34		3.33	
6	a	2.03	2.16	2.49	2.40	2.50	2.51
	b	2.08		2.39		2.38	
	c	2.14		2.22		2.44	
	d	2.38		2.62		2.70	
7	a	2.06	2.13	2.27	2.31	3.15	3.15
	b	2.10		2.32		3.40	
	c	2.12		2.24		3.07	
	d	2.24		2.42		2.96	

B.2.3. NUMBER OF BUD AND FLOWER

Time (d)												
	0		3		8		12		15		23	
No	x	Σx	\bar{x}	Σx	x	Σx	x	Σx	x	Σx	x	Σx
1	a	1B	7B	1B	8B	2B	9B1F	5B	13B4F	5B	15B4F	5B
	b	2B		2B		3B		3B1F		4B1F		3B2F
	c	3B		4B		3B1F		2B3F		3B3F		2B4F
	d	1B		1B		1B		2B		4B		5B1F
2	a	2B	5B	3B	5B2F	2B1F	6B1F	3B1F	14B3F	4B1F	18B3F	4B2F
	b	--		1B		1B		4B		5B		5B
	c	1B		1B		2B		5B		6B		5B1F
	d	2B		2F		1B		2B2F		3B2F		4B2F
3	a	2B	7B	2B	8B	2B	9B1F	4B	14B2F	5B	22B1F	6B1F
	b	2B		2B		3B		4B1F		7B1F		9B1F
	c	2B		3B		4B		5B		6B		5B1F
	d	1B		1B		1F		1B1F		4B		5B1F
4	a	2B	3B	3B	8B	2B1F	7B1F	4B2F	11B3F	5B2F	22B3F	9B2F
	b	-		3B		3B		4B		5B		6B
	c	-		1B		1B		2B		6B		15B
	d	1B		1B		1B		1B1F		6B1F		10B1F
5	a	5B	19B	4B2F	17B6F	3B3F	12B11F	5B1F	5B19F	4B5F	20B14F	7B5F
	b	6B2F		5B3F		3B3F		6F		6F1B		3B6F
	c	5B1F		4B2F		3B2F		1B5F		2B6F		4B6F
	d	3B1F		4B1F		3B3F		3B3F		7B3F		6B4F
6	a	1B	2B	1B	4B	1B	3B1F	2B	5B1F	3B	5B1F	3B
	b	-		1B		1F		1F		1F		1F
	c	-		1B		1B		2B		2B		2B
	d	1B		1B		1B		1B		1B		1B
7	a	4B1F	19B5F	4B1F	17B7F	5B2F	22B10F	4B4F	14B20F	6B5F	16B23F	5B6F
	b	4B2F		4B2F		5B3F		6B2F		2B6F		2B6F
	c	5B2F		4B3F		6B4F		4B6F		3B7F		2B8F
	d	6B		5B1F		6B1F		4B4F		5B5F		6B5F

B.2.4. DIAMETER OF FLOWER (mm)

Time (d)	8		12		23		
	\bar{x}	\bar{X}	\bar{x}	\bar{X}	\bar{x}	\bar{X}	
1	a	-	-	-	-	-	
	b	2.9	1.43	2.95	1.97	3.10	2.43
	c	2.82		2.87		3.70	
	d	-		-		-	
2	a	-	2.50	2.19	2.61	2.72	
	b	-	-		-		
	c	-	2.15		3.07		
	d	4.01	4.10		4.20		
3	a	-	2.26	2.46	3.60	3.85	
	b	2.05	3.00		4.65		
	c	1.90	1.10		3.70		
	d	4.55	3.80		3.45		
4	a	4.10	4.15	2.60	5.28	3.68	
	b	-	-		-		
	c	-	2.00		4.10		
	d	3.90	4.25		5.33		
5	a	2.71	2.68	2.88	3.07	3.04	
	b	2.82	2.85		2.90		
	c	2.84	2.92		2.97		
	d	2.92	3.05		3.22		
6	a	-	-	0.61	-	0.66	
	b	2.35	2.42		2.65		
	c	-	-		-		
	d	-	-		-		
7	a	1.05	2.20	1.68	3.28	2.91	
	b	-	1.10		2.45		
	c	2.07	1.28		2.80		
	d	2.00	2.12		3.10		

B.2.5. Root Length and Root Width (cm)

Number of Plant	Composition of Mixture											
	0%		20%		40%		60%		80%		100%	
	a	b	a	b	a	b	a	b	a	b	a	b
1	5.0	3.0	6.0	5.0	4.2	2.0	3.5	2.5	2.7	2.6	4.2	2.5
2	4.5	5.0	5.0	4.5	3.5	3.8	4.2	2.5	2.7	4.0	3.8	1.0
3	4.0	2.5	6.6	2.5	4.2	4.0	3.5	3.0	3.2	3.5	3.6	2.2
4	3.5	2.3	5.5	3.2	3.8	2.2	4.5	5.5	5.5	1.2	3.0	2.0
5	4.5	2.0	4.5	3.0	4.0	3.4	4.6	4.0	6.0	2.0	4.2	2.5
6	3.5	3.5	6.0	5.5	4.2	1.5	6.0	1.8	4.0	2.5	4.0	3.0
7	4.0	1.8	5.5	6.2	4.0	3.5	4.8	2.6	3.0	2.8	3.5	1.0
8	4.0	1.5	6.3	6.2	4.0	3.5	3.6	2.7	3.9	1.6	3.5	3.5
9	4.5	2.5	6.0	4.5	4.5	3.0	3.3	2.5	3.5	1.4	4.5	3.0
10	5.0	2.9	5.6	4.3	5.5	3.0	3.4	3.4	3.9	1.6	3.2	2.8
\bar{X}	4.25	2.7	5.7	4.5	4.2	3.0	4.1	3.0	3.8	2.0	3.7	2.3

a: Root Length

b: " width

B.2.6. Wet Weight of Plants

Number of Plant	Composition of Mixture					
	0%	20%	40%	60%	80%	100%
1	1.74	4.38	7.76	12.39	13.05	5.82
2	2.10	4.42	8.47	7.84	16.20	3.37
3	2.54	5.30	7.42	4.48	13.43	4.70
4	2.01	4.76	4.73	3.88	6.78	3.78
5	2.38	4.07	3.98	5.23	20.35	5.57
6	2.18	5.55	12.20	8.65	13.24	11.98
7	1.23	4.25	12.78	6.52	5.06	3.63
8	2.61	6.15	5.04	3.38	5.94	5.17
\bar{X}	2.09	4.86	7.80	6.55	11.74	5.50

B.2.7. DRY WEIGHT OF PLANTS (g)

Composition of Mixture	Root	Leaf	Stem	Flower
0%	1.1720	1.3175	1.6882	0.4220
20%	1.6135	5.35	2.5440	2.1735
40%	4.3561	14.673	6.4040	-
60%	2.7711	8.4540	3.8080	2.0917
80%	9.7866	22.93	10.09	1.4775
100%	1.5442	7.7036	3.3136	5.1704

B.2.8. ROOT VOLUME-WEIGHT-LENGTH RELATIONS

Composition of Mixture	\bar{X} (cm ³) Root volume	(gr) Total weight	weight above ground (gr)	Stem (l) Length(cm)
0%	15.37	0.58	0.42	1.39
20%	11.93	1.46	1.26	6.09
40%	28.98	3.18	2.63	6.30
60%	29.69	2.14	1.79	6.74
80%	90.65	5.53	4.31	7.80
100%	24.33	2.21	2.02	4.21

(l) : Stem Length = Last length-first length