



**HUMAN IDENTIFICATION WITH PALMPRINT BASED ON LOCAL  
BINARY PATTERN**

**JANAN FARGO**

**JANUARY 2015**

**HUMAN IDENTIFICATION WITH PALMPRINT BASED ON LOCAL  
BINARY PATTERN**

**A THESIS SUBMITTED TO  
THE GRADUATE SCHOOL OF NATURAL AND APPLIED  
SCIENCES OF  
ÇANKAYA UNIVERSITY**

**BY  
JANAN FARGO**

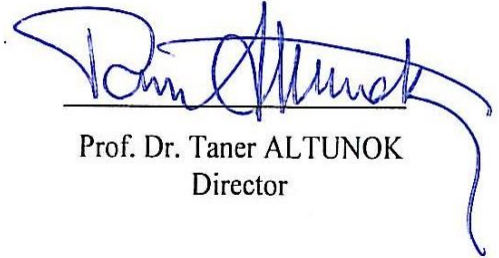
**IN PARTIAL FULFILLMENT OF THE REQUIREMENTS FOR THE  
DEGREE OF  
MASTER OF SCIENCE  
IN  
THE DEPARTMENT OF MATHEMATICS AND COMPUTER SCIENCE  
INFORMATION TECHNOLOGY PROGRAM**

**JANUARY 2015**

Title of the Thesis : **Human Identification with Palmprint Based on Local Binary Pattern.**

Submitted by **Janan FARGO**

Approval of the Graduate School of Natural and Applied Science, Çankaya University.



Prof. Dr. Taner ALTUNOK  
Director

I certify that this thesis satisfies all the requirements as a thesis for the degree of Master of Science.



Prof. Dr. Billur KAYMAÇALAN  
Head of Department

This is to certify that we have read this thesis and that in our opinion it is fully adequate, in scope and quality, as a thesis for the degree of Master of Science.



Assist. Prof. Dr. Yuriy ALYEKSYEYENKOV  
Supervisor

**Examination Date: 22.01.2015**

**Examining Committee Members**

Assist. Prof. Dr. Yuriy ALYEKSYEYENKOV (Çankaya Univ.)

Assoc. Prof. Dr. Fahd JARAD (THK Univ.)

Assist. Prof. Dr. Abdül Kadir GÖRÜR (Çankaya Univ.)



## STATEMENT OF NON-PLAGIARISM PAGE

I hereby declare that all information in this document has been obtained and presented in accordance with academic rules and ethical conduct. I also declare that, as required by these rules and conduct, I have fully cited and referenced all material and results that are not original to this work.

Name, Last Name : Janan, FARGO

Signature

:



Date

: 22.01.2015

## **ABSTRACT**

### **HUMAN IDENTIFICATION WITH PALMPRINT BASED ON LOCAL BINARY PATTERN**

FARGO, Janan

M.Sc., Department of Mathematics and Computer Science  
Information Technology Program

Supervisor: Assist. Prof. Dr. Yuriy ALYEKSYEYENKOV

January 2015, 51 pages

Palmprint recognition is one of the research areas is considered in recent years. In this thesis, we introduce a new method for human Palmprint identification system with local binary pattern. First, the palm images are preprocessing with morphological technics. Then the feature extraction for images is applied. We used local binary pattern and gray level Co-occurrence matrix for desired features. This approach is tested for 500 people and there are 1, 2, 3... 7 image from each people. Our method is compared with PCA method and Wavelet continuous transformation. The result shows that proposed method is efficiency and good performance for Palmprint recognition.

**Keywords:** Identification, Palmprint, Local Binary Pattern.

## ÖZ

### YEREL İKİLİ DESEN DAYALI PALMPRINT İLE İNSAN TANITIM

FARGO, Janan

Yüksek Lisans, Matematik - Bilgisayar Anabilim Dalı

Bilgi Teknolojileri Bölümü

Tez Yöneticisi: Yrd. Doç. Dr. Yuriy ALYEKSYEYENKOV

Ocak 2015, 51 sayfa

Avuç içi tanıma son yıllarda kabul edilen araştırma alanlarından biridir. Bu tezde, yerel ikili desen insan Palmprint tanımlama sistemi için yeni bir yöntem tanıtmak. İlk olarak, palmiye görüntüleri morfolojik teknikleri ile önışlemededir. Sonra özellik çıkarma görüntüler için uygulanır. Biz yerel ikili desen ve istenilen özellikler için gri seviye Co-oluşumu matrisi kullanılır. Bu yaklaşım, 500 kişi için test edilmiştir ve her bir insan dizisinden 1, 2, 3 ve 4 görüntü vardır. Önerilen yöntem, PCA yöntemi ile karşılaştırılır. Sonuç önerilen yöntem verimliliği ve Palmprint tanınması için iyi bir performans olduğunu göstermektedir.

**Anahtar Kelimeler:** Kimlik Tanıma, Avuç İçi Tanıma, Yerel İkili Desen.

## **ACKNOWLEDGEMENTS**

Sometimes a moment in your life will remain forever in the memory does not matter how long life it will be continue, I will never forget this moment forever.

First, I extend my special thanks is given to The Graduate School of Natural and Applied Sciences the Department of Information Technology of Çankaya University.

In addition, I would like to express my deep gratitude to my great supervisor, Asst. Prof. Dr. Yuriy ALYEKSYEYENKOV, who gave me unlimited supporting and valuable guidance's, there is no enough words to express thanks for you.

Finally, but not the least important, I owe more than thanks to my family members and my friends for their support and encouragement throughout my life. Without their support, it is impossible for me to finish my college and graduate education seamlessly.

## TABLE OF CONTENTS

STATEMENT OF NON PLAGIARISM.....	iii
ABSTRACT.....	iv
ÖZ.....	v
ACKNOWLEDGEMENTS.....	vi
TABLE OF CONTENTS.....	vii
LIST OF FIGURES.....	x
LIST OF TABLES .....	xii
LIST OF ABBREVIATIONS .....	xiii

### CHAPTERS:

1. INTRODUCTION.....	1
1.1. Background .....	1
1.2. Properties of Biometric.....	1
1.3. Verification and Identification .....	2
1.3.1. Finger scan.....	2
1.3.2. Facial scan.....	3
1.3.3. Iris scan .....	4
1.4. DNA Recognition .....	5
1.5. Retina Recognition .....	5
1.6. Voice Recognition .....	5
1.7. Desired Features in a Biometric and Palmprint .....	6
2. PATTERN RECOGNITION SYSTEM .....	8
2.1. Background .....	8
2.2. Image Processing Principles .....	9
2.2.1. Image obtained.....	11
2.2.2. Image enhancement .....	11
2.2.3. Image restoration .....	12
2.2.4. Color image processing .....	12



2.2.5.	Compression .....	12
2.2.6.	Morphological processing .....	12
2.2.7.	Segmentation .....	12
2.2.8.	Database .....	13
2.3.	Techniques Used in Image Processing .....	13
2.3.1.	Shadow correction .....	13
2.3.2.	Normalization .....	13
2.3.3.	Thresholding .....	14
2.4.	Image Improvement and Repair Methods.....	15
2.4.1.	Sharpness filter .....	15
2.4.2.	Pollution removal .....	16
2.4.3.	Finding edge .....	17
2.5.	Image Processing Application Areas .....	18
2.6.	Histogram.....	18
2.6.1.	Histogram Thresholding.....	19
3.	FEATURE EXTRACTION METHODS.....	20
3.1.	Local Binary Patterns (LBP).....	20
3.2.	The Uniform Local Binary Pattern .....	23
3.3.	Appearance Histogram .....	24
3.4.	Evaluating and Choosing a Distance Function in System Performance.....	24
3.5.	Wavelet Theory.....	25
3.5.1.	Wavelet transform.....	25
3.5.2.	Continuous wavelet transform.....	26
3.5.3.	Discrete wavelet transform.....	27
3.5.4.	Fast wavelet transform.....	27
3.5.5.	Discrete cosine transform.....	28
3.6.	Summary of Previous Work Related of Palmprint.....	30
3.7.	Palmprint People Based Recognition.....	32

<b>4. IDENTIFICATION BY THE PALMPRINT USING A LOCAL BINARY</b>	
<b>PATTERN</b> .....	34
<b>4.1. Background</b> .....	34
<b>4.2. Local Binary Pattern (LBP)</b> .....	36
<b>4.2.1. Description of the local binary pattern</b> .....	36
<b>4.2.2 The uniform local binary pattern</b> .....	37
<b>4.3. Histogram of Appearance</b> .....	38
<b>4.4. Co-occurrence Matrix</b> .....	38
<b>4.5. Appearance Database</b> .....	39
<b>4.6. Simulation Results</b> .....	41
<b>4.6.1. Evaluating and choosing a distance function in system</b> <b>performance</b> .....	41
<b>4.7. Experimental Results</b> .....	43
<b>5. CONCLUSION</b> .....	51
<b>REFERENCES</b> .....	R1
<b>APPENDICES</b> .....	A1
<b>A. CURRICULUM VITAE</b> .....	A1

## LIST OF FIGURES

### FIGURES

<b>Figure 1</b>	Voice recognition .....	6
<b>Figure 2</b>	Pattern recognition system .....	8
<b>Figure 3</b>	A material images and numerical shape.....	10
<b>Figure 4</b>	The digitization of an image.....	10
<b>Figure 5</b>	A continuous picture of digitizing shape. [M, N] where similar single point numerically, brightness, etc. shown in value.....	11
<b>Figure 6</b>	The threshold value.....	14
<b>Figure 7</b>	Thresholding before and after images.....	14
<b>Figure 8</b>	Sharpness laplacian filter Is applied to be improved compared with the original image.....	15
<b>Figure 9</b>	Comparison of different techniques made using decontamination operations.....	16
<b>Figure 10</b>	Sobel edge detection is carried out using gradient operation .....	17
<b>Figure 11</b>	Image histogram.....	19
<b>Figure 12</b>	Histogram equalized palmprint image.....	19
<b>Figure 13</b>	Local binary pattern architecture .....	20
<b>Figure 14</b>	The basic LBP operator.....	21
<b>Figure 15</b>	The circular (8,2) neighborhood.....	21
<b>Figure 16</b>	An example of a facial image divided into 7x7 windows .....	22
<b>Figure 17</b>	Two-dimensional analysis filter bank.....	27
<b>Figure 18</b>	Palmprint images in different wavelet sub-band words.....	29
<b>Figure 19</b>	An example implementation in the palmprint of gabor wavelets .....	29
<b>Figure 20</b>	The design principle of a palmprint capture system.....	33

## FIGURES

<b>Figure 21</b>	Image acquisition device and the sample images which is captured by it .....	40
<b>Figure 22</b>	Some samples of one palmprint after preprocessing .....	40
<b>Figure 23</b>	The changes in accuracy percentage terms of the training number images each person .....	44
<b>Figure 24</b>	Rotational invariant uniform $R = 3, P = 24$ .....	45
<b>Figure 25</b>	Rotational invariant uniform $R = 2, P = 16$ .....	46
<b>Figure 26</b>	Rotational invariant uniform $R = 1, P = 8$ .....	46
<b>Figure 27</b>	Rotational invariant $R = 3, P = 24$ .....	47
<b>Figure 28</b>	Rotational invariant $R = 2, P = 16$ .....	48
<b>Figure 29</b>	Rotational invariant $R = 1, P = 8$ .....	48
<b>Figure 30</b>	Uniform $R = 3, P = 24$ .....	49
<b>Figure 31</b>	Uniform $R = 2, P = 16$ .....	50
<b>Figure 32</b>	Uniform $R = 1, P = 8$ .....	50

## LIST OF TABLES

### TABLES

<b>Table 1</b>	Comparing the Results of Proposed System with Other Procedures Performed on the Database .....	42
----------------	---	----

## LIST OF ABBREVIATIONS

CCD	Charge-Coupled Device
CCTV	Closed-Circuit Television Camera
COP	Consistent Orientation Pattern
DC	Direct Current
DCT	Discrete Cosine Transform
DFT	Discrete Fourier Transform
DNA	Deoxyribonucleic Acid
DWT	Discrete Wavelet Transform
FFT	Fast Fourier Transformation
FMR	False Match Rate
FTER	Failure-To-Enroll Rate
GLCM	Gray Level Co-Occurrence Matrix
IBIA	International Biometric Industry Association
JPEG	Joint Photographic Experts Group
LBP	Local Binary Pattern
MRTD	Machine Readable Travel Documents
MSA	Mean-Square Error
PCA	Principle Component Analysis
RMS	Root Mean-Square Error
SNR	Signal-To-Noise Ratio
SVM	Support Vector Machine

## **CHAPTER 1**

### **INTRODUCTION**

#### **1.1 Background**

Because biometric based authentication is emerging as a powerful method for reliable authentication, which is of great importance in our lives, biometrics is becoming increasingly popular.

In 2001, the highly respected MIT Technology Review announced biometrics as one of the “top ten emerging technologies that will change the world” [1]. In addition, Rick Norton, the executive director of the International Biometric Industry Association (IBIA), pointed out the increase in biometric revenues by an order of magnitude over the recent years. Biometric revenues, which were \$20 million in 1996, increased by 10 times and reached \$200 million in 2001. Rick Norton expects a similar increase in biometric revenues in next 5 years period, from 2001 to 2006, thereby expecting them to reach \$2 billion by 2006[1]. Similarly, International Biometric Group, a biometric consulting and integration company in New York City, estimate biometric revenues to be around \$1.9 billion in 2005[1].

#### **1.2 Properties of Biometric**

Researchers noticing the increase in biometric revenues are trying to develop better algorithms for existing biometrics and/or to find new biometrics for authentication. Whether new or existing, all practical biometrics should possess five properties described below [2]:

1. Universality: All individuals should possess the biometric characteristics.
2. Uniqueness: The biometric characteristics of different individuals should not be the same.

3. Permanence: The biometric characteristics of individuals should not change severely with the time.
4. Collectability: The biometric characteristics should be measurable with some practical device.
5. Acceptability: Individuals should not have objections to the measuring or collection of the biometric.

### **1.3 Verification and Identification**

The most important distinction in biometrics is between verification and identification. Verification systems verify or reject user's identity. In verification systems, the user is requested to prove that he/she is the person he/she claims to be.

Therefore, the user should first claim an identity by providing a username or an ID number. After claiming the identity, the user provides a biometric data to be compared against his or her enrolled biometric data. The biometric system then returns one of two possible answers, verified or not verified. Verification is usually referred to as 1:1 (one-to-one), since the biometric data provided by the user is only compared against the enrolled biometric data of the person that the user claims to be. Identification systems, on the other hand, try to identify the person providing the biometric data. In identification systems, the user is not required to claim an identity; which is not the case in verification systems, instead he/she is only requested to provide a biometric data. Another difference of identification from verification is that user's biometric data is compared against a number of users' biometric data. Therefore, identification is generally referred as 1: N (one-to-N or one-to-many). Then the system returns an identity such as a username or an ID number.

#### **1.3.1 Finger scan**

Finger-scan is a well-known biometric technology, which is used to identify and verify individuals based on the discriminative features on their fingerprints. Many finger-scan technologies are based on minutiae points, which are irregularities and discontinuities characterizing fingerprint ridges and valleys. [3] Advantages of Finger-Scan Technology as follow:



- It is proven to have very high accuracy.
- It does not require complex user – system interaction; therefore little user training is enough to ensure correct placement of fingers.
- It provides the opportunity to enroll up to 10 fingers.

Disadvantages of Finger-Scan Technology as follow:

- High resolution images are required to be acquired due to the small area of a fingerprint and this results in more expensive acquisition devices.
- Small percentage of users; elderly populations, manual laborers and some Asian populations; are shown to be unable to enroll in some finger-scan systems according to International Biometric Group's Comparative Biometric Testing. [3]
- As mentioned before, some people may tend to wear down their fingerprints in time because of their physical work.
- Individuals may have objections to collection of their fingerprints because they may have doubts about usage of their fingerprints for forensic applications.

### **1.3.2 Facial scan**

Facial-scan is a biometric technology, which is used to identify and verify individuals based on the discriminative features on their faces. Nonetheless, it is generally used for identification and surveillance instead of verification. Facial-scan technologies use some of many discriminative features on face such as eyes, nose, lips etc. [3] Advantages of Facial-Scan Technology as follow:

- It is the only biometric which provides the opportunity to identify individuals at a distance avoiding user discomfort about touching a device.
- It can use images captured from various devices from standard video cameras to CCTV cameras.

### Disadvantages of Facial-Scan Technology

- Changes in lighting conditions, angle of acquisition and background composition may reduce the system accuracy.
- The face is a reasonably changeable physiological characteristic. Addition or removal of eyeglasses, changes in beard, moustache, make-up and hairstyle may also reduce the system accuracy.
- In order to take changes in environmental conditions and user appearance into account, facial-scan technologies usually store many templates for each compared to many other biometrics.
- Because face of users may be acquired without their awareness, users may have objections to facial-scan deployments.

### 1.3.3 Iris scan

Iris-scan is a biometric technology, which used to identify and verify individuals based on the distinctive features on their irises.

Iris-scan technologies use the patterns that constitute the visual component of the iris to discriminate between individuals. [3]

Advantages of Iris-Scan Technology as follow:

- It is proven to have smallest FMR among all biometrics, therefore, iris is the most suitable biometric for applications requiring highest level of security.
- Iris does not change in time, therefore; it does not require reenrollment which other technologies require after a period of time due to changes in the biometric.

Disadvantages of Iris-Scan Technology as follow:

- It requires complex user – system interaction, particularly precise positioning of head and eye. Some systems even require that users do not move their head during acquisition.
- Very high resolution images are required to be acquired due to the small area of an iris, therefore; acquisition devices are quite expensive.

- There is a public objection to using an eye-based biometric even though many people are not aware of the fact that infrared illumination is used in iris-scan technology. Were they aware, they might be a much stronger reaction to this technology.

#### **1.4 DNA Recognition**

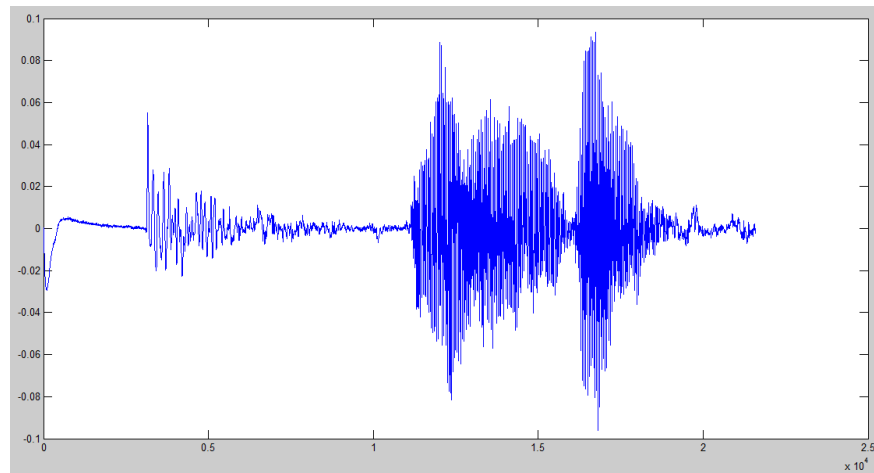
Deoxyribonucleic acid was discovered in 1985, the first time that every human being is an exclusive mark. DNA recognition systems still one of the most reliable authentication system and is implemented in most paternity tests and judicial proceedings. DNA recognition in the hair, blood and other biological data are analyzed.

#### **1.5 Retina Recognition**

The retina is examined by optical devices based on the concept of the specific structure of each person and reliability of this technology is good. However, it is difficult to implement user from having to look at a certain point. Although adequate for this reason the technology was not accepted.

#### **1.6 Voice Recognition**

In voice recognition, priorities of expression are required to recognize the signals correctly. In other words, it housed the review of the audio signal and only element of recognition-targeted sounds, determined by applying various digital signal processing techniques in succession. Then the specified element needs to be represented by a feature vector. These attributes with voice recognition database is created. Figure 1 also shows an audio recording.



**Figure 1: Voice recognition**

### **1.7 Desired Features in a Biometric and Palmprint**

As it is seen, all biometric technologies mentioned above have both advantages and disadvantages. In other words, there is no perfect biometric technology that has no disadvantage. However, it is possible to figure out the desired features in a biometric technology by inspecting advantages and disadvantages of the biometric technologies above. The list of desired features in a biometric technology is given below:

- High Accuracy
- Zero or very small FTER
- Permanence of biometric in time
- Utilization of cheap acquisition devices
- Resistance to changes in environmental conditions
- No or very little public objection (Acceptability)
- Small template size
- Simple user – system interaction

Inspecting the list above, voice-scan mainly suffers from lower accuracy and higher template size. Facial-scan may not provide the required accuracy due to changes in environmental conditions and user appearance. Although iris is the most reliable biometric, high cost of acquisition devices used in order to scan iris is the biggest handicap of this technology. Finger-scan has a very high accuracy with simple user

system interaction and small template size. Nevertheless, physical work and age may cause people not to have clear fingerprints. Additionally, possible dirt and grease on fingerprints may reduce the system accuracy. Were the area of fingerprint larger, finger-scan technology might suffer less from effects of dirt, physical work and age on fingerprints. Palmprint, on the other hand, provides a large area for feature extraction and seems to suffer less from factors that reduce the accuracy in finger-scan technology. Moreover, large area of Palmprint enables utilization of low resolution

Images resulting in cheaper acquisition devices. Furthermore, a very small FTER is expected in Palmprint-scan applications because it is easy to correctly place Palmprint on a desired platform. Due to the same reason, it is possible to have a system with simple user – system interaction. Additionally, Palmprint-scan is a promising biometric technology to have high accuracy because Palmprint is covered with a similar skin as fingerprint. Finally, Palmprint-scan technology has high user acceptance which is quite necessary for the technology to spread out. As it is seen, Palmprint possesses the most of desired features therefore; it may be used as a biometric. The next chapter will describe some Palmprint recognition algorithms in the literature and will explain results obtained in these algorithms.

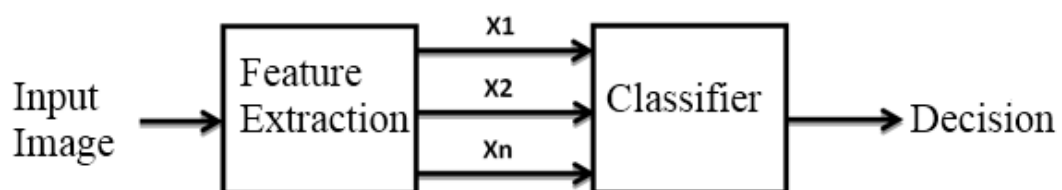
In Chapter 2 the pattern recognition system is introduced. Chapter 3 is about Feature Extraction and chapter 4 is Identification by the Palmprint Using a Local Binary Pattern. Then we finished our thesis with conclusion in chapter 5.

## CHAPTER 2

### PATTERN RECOGNITION SYSTEM

#### 2.1 Background

As patterns of computers in recent years has made people a lot of work to be able to distinguish. Some of the characters studied patterns, symbols, pictures, sound waves are electrocardiogram. Often difficult to interpret due to the complex calculations or assessments are used in computerized recognition that human overload problems. The simplest way is matching the pattern recognition template. In this case, templates are stored in memory in the form of database, including a template set for each pattern class. Unknown class is compared with the template of each class. Classification is performed according to a predetermined matching criterion or similarity criteria. Rather than compare it with the complete pattern template to compare some of the features often gives faster and more accurate results. For this reason the process of pattern recognition, feature extraction and classification is examined in two separate stages, including [4].



**Figure 2:** Pattern recognition system [5]

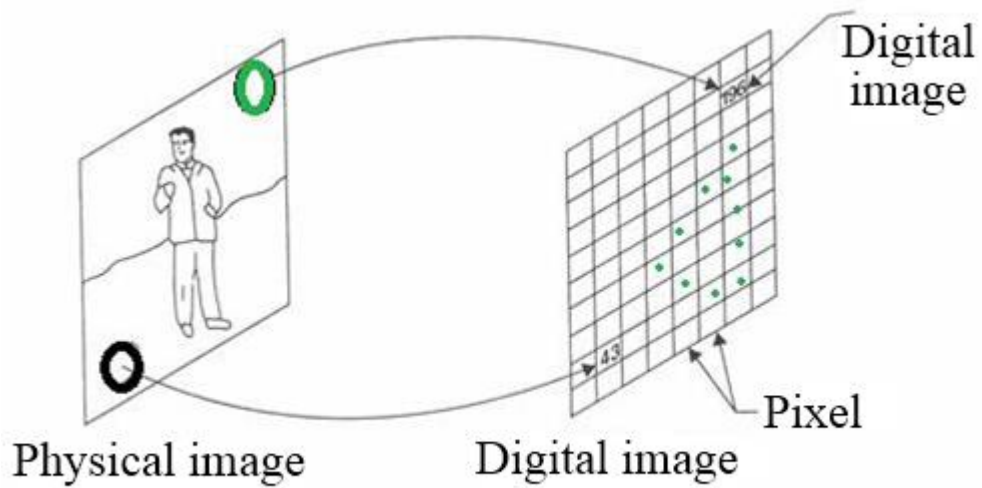
Figure 2 in feature extraction, the results of doing some measurements on the pattern makes a feature vector. This feature may vastly differ depending on the nature of the problem. In addition, severity and costs relative to each other properties can be different. Therefore, better distinguished from each other classes of properties and

obtained costs must be selected to be low. Features are different for each pattern recognition problem [6].

In the classification phase of the object based on the extracted features are judged to belong to which class. Pattern recognition is concerned with the interpretation or recognition of image samples and aim to achieve the classification process by learning about the view. Two major classification technique using a template matching and feature extraction is performed [7]. Template matching is the most common classification methods. In this method each pixel of the image feature. Classification is done by comparing the input image of the entire class template. The comparison results occur similarity measure between the template and input information. Pixel of the input image with the template increases the degree of similarity on the basis of equality, the corresponding differences in each pixel reduces the similarity. Maximum degree of similarity of the template class that makes after comparing all the templates is selected. Structural classification technique uses structural features and decision rules to know the classes of patterns.

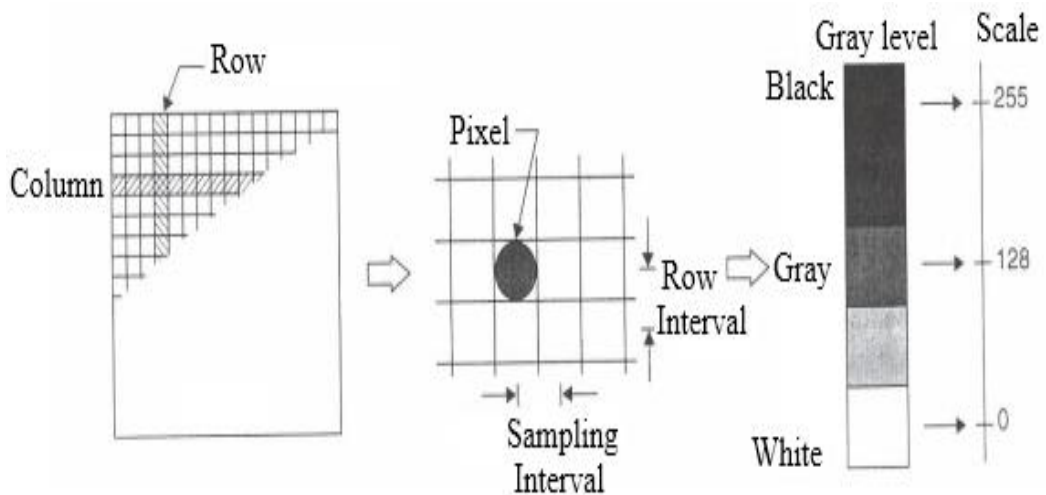
## **2.2 Image Processing Principles**

In its most simple expression, blur processing, images necessary to handle a vehicle and is important two demand input-output hardware heard digitization and image display device. Due to the natural structure of this device directly to a computer analysis of the images constitute a source. Computers not with image data they are working with numerical values, Before you start processing, the image should be converted to a numeric format. Figure 3 a substantially rectangular image of the sequence number, shows how to represent. Material image, shape elements or "pixels" is divided into small regions called. The most comprehensive sub-partitioning scheme that quadrilateral sampling grid was transferred to the device in Figure 3.



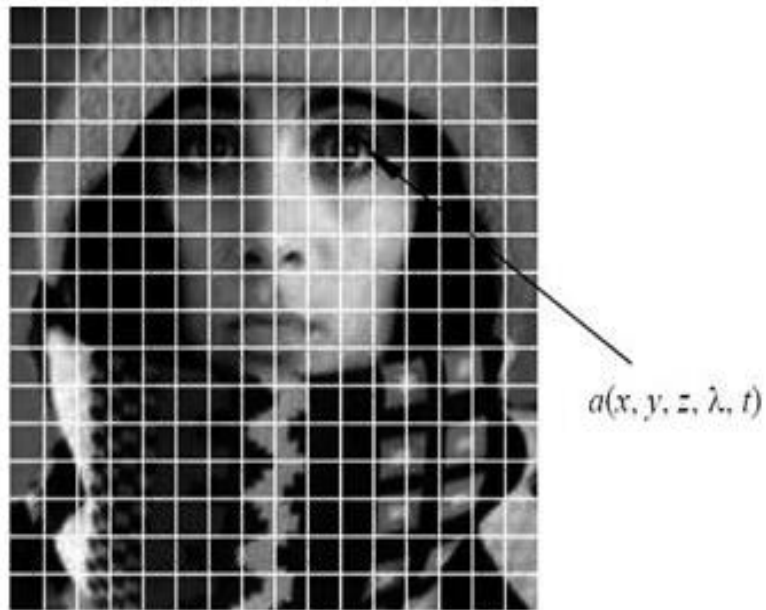
**Figure 3:** A material images and numerical shape [8].

The conversion process is called numerical. Examples of brightness of each pixel of the image and used as numeric. This part of the process, each pixel that represents the brightness or darkness of the place. This process is shown in the picture format is applied to all pixels in a rectangular array. Each pixel location or a complete track (with line and column numbers) and has an exact value also called gray levels. This sequence numeric data is currently processed in a suitable state for the computer. Figure 4 shows the version of the continuous numerical image.



**Figure 4:** The digitization of an image [8]





**Figure 5:** A continuous picture of digitizing shape.  $[M, N]$  where similar single point numerically, brightness, etc. shown in value [9].

Digital image processing can be divided into two main groups; that the input and output method of the image, the second group of images may be entered, but where are the methods of stamps issued from the images came out.

### **2.2.1 Image obtained**

Obtained first work to image shown in Figure 5, using essentially the general may be given as a numerical data, The prototyping process is referred to as preprocessing.

### **2.2.2 Image enhancement**

Is one of the most practical image processing section. Basically, the main idea behind the image stabilization methods, the presence of overlooked details or a form of fixed properties is shown in the foreground. The original process is to increase the contrast of the image.

### **2.2.3 Image restoration**

Image restoration makes a better picture. Image is a subjective process improvement, repair is a concept image objective. The renewal of the image missing mathematical and forecasting forms are used.

### **2.2.4 Color image processing**

Proliferation of the use of color digital pictures on the Internet increases the importance of this issue is the effect.

### **2.2.5 Compression**

As is evident in the name of an image that ought to be stored is concerned with reducing the amount of certain discs. Covering technology more advanced, though quite recently, the same cannot be said for technology transfer size.

This has become especially important in image content with the use of the internet. Known form of computer users JPEG is an image compression standard certificate extension.

### **2.2.6 Morphological processing**

Morphological processing depends on the image displayed in the image and shape of the unknown in useful components used in obtaining the device.

### **2.2.7 Segmentation**

The segmentation process is one of the most challenging image processing functions. No matter how genuine segmentation, recognition process is so true.

### **2.2.8 Database**

Known about a problem can often encode in the database thanks to an image processing device. Database as well as to guide each processing, enable communication between the modules.

## **2.3. Techniques Used In Image Processing**

### **2.3.1 Shadow correction**

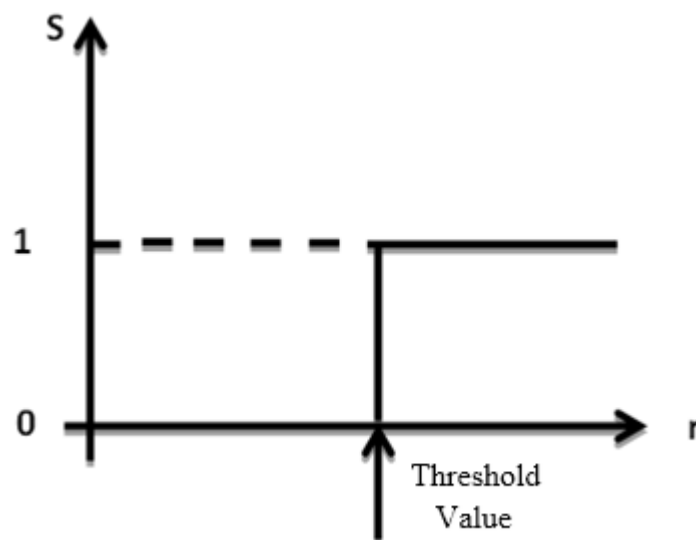
Images was obtained from material objects, you can create shadows on the picture obviously still due from the sparkle, buyer or real objects. Some appeared in the pictures bright edges closer to the middle or middle aggravated opposite happens in a case of this kind of work right brightens the dark borders. On the other hand, know the easiest way to shine left or right of the image can be replicated. Shadowing, non-uniform illumination, camera-sensitive non-uniform, even the lens is dirty, not even occur. Therefore, shadowing phenomenon is undesirable. However, the image becomes objective image analysis prior to recovering from this case [11].

### **2.3.2 Normalization**

Processes are performed before starting the processing of the image. This should be as short as pretreatment. Because normalization until the intent to be used for the algorithm is to examine the response of redundant information and action. The size of the image from the scanner are different resolutions from each other. Color images from the browser is changed to gray levels. If the size of this image was being done, and this is done with image processing and analysis stage of the learning neural network takes a long time. In fact, it increases the time to use large size and decrease in the yield of the process. Therefore, images from the scanner should reduce a certain standard [12]. As a result of these assumptions, the number of pixels of the images in our program implementation was changed to  $128 \times 128$ .

### 2.3.3 Thresholding

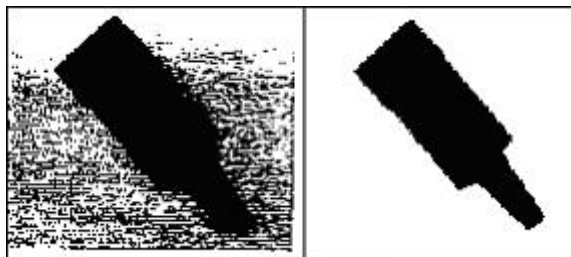
One of the methods used in image processing threshold based. The purpose of making a numerical image thresholding operation is convenience in determining the properties of the image. With a unique gray level image, i.e. to show it in black and white binary image can be altered expression in two colors. Before the thresholding process image has a threshold value. It had done by selected a threshold value as in Figure 6. Is higher than the threshold gray level value of the 1 pixel value and the smallest values of the pixel value of 0 is assigned, then the image is changed to a simpler shape in black and white. The image in Figure 7. Prior to the thresholding process (left) and the next state (right) is seen [13].



**Figure 6:** The threshold value [7]

$$r \geq th \Rightarrow s = 1 \quad (2.1)$$

$$r < th \Rightarrow s = 0 \quad (2.2)$$



**Figure 7:** Thresholding before and after images [13]

## 2.4 Image Improvement and Repair Methods

When obtaining digital image often leads to losses in the picture. This case of mechanical problems, focusing on issues of, the movement of the lens, resulting from unsuitable lighting pollution, creates a digital image worse than the original shape. The purpose of image enhancement, starting from an image was visually document is to achieve optimal image. The purpose of image restoration is to achieve an image closest to the original image starting from an image recorded. The purpose of image enhancement beautification and the purpose of image restoration is a reality [14].

### 2.4.1 Sharpness filter

Image well-known method of image stabilization technique is to highlight the edges of the image. The method is called sharpness filtering. Means improving the sharpness filter edges in an image at first be removed from the edges of the strengthening and after addition of a so-called image [14]. Figure 8 shows an improved image sharpness using the Laplacian filter.

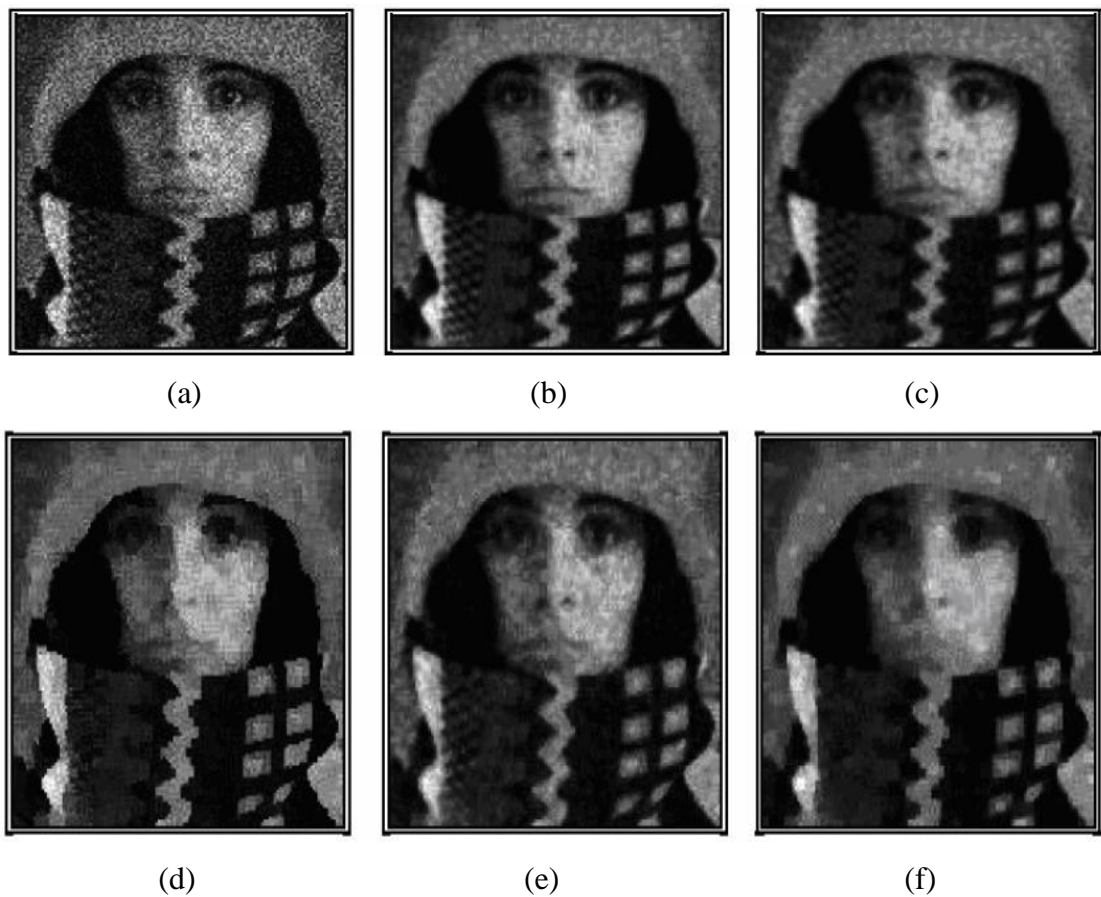


**Figure 8:** Sharpness laplacian filter is applied to be improved compared with the original image [14]

## 2.4.2 Pollution removal

Destruction process called pollution in the best filtration masks are used linear Wiener mask. Here's the most appropriate word to mean square error (mean-square error - MSA) is used for giving. The most suitable mask, it is also the root mean square errors (root mean-square error - RMS) is minimal. 5 different methods for the decontamination process is shown in Figure 9.

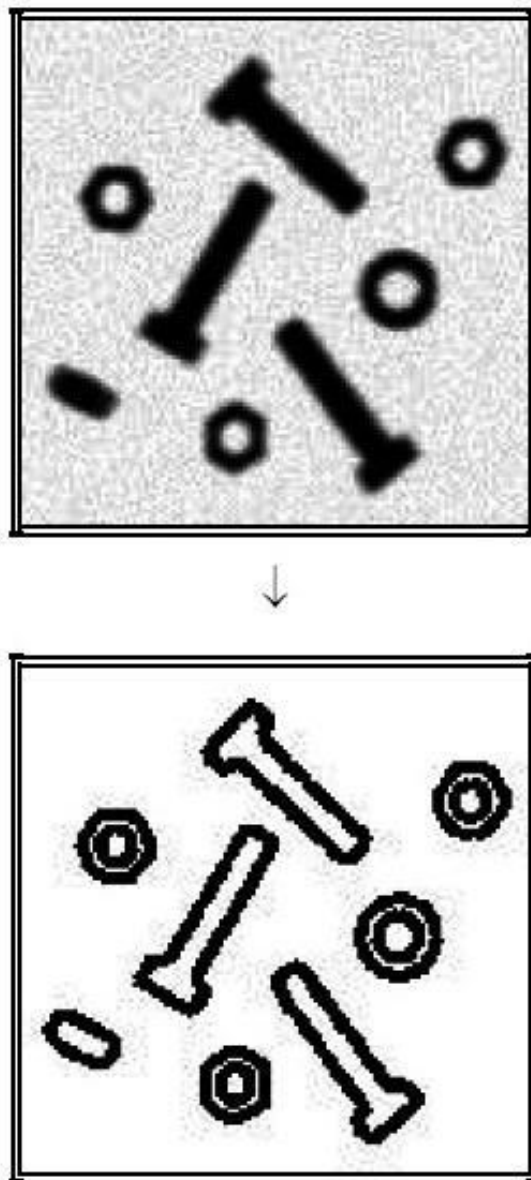
An image mask are known to Image spectrum and spectrum of impurities was used. Values of other masks (neighborhood size, etc.) RMS is made being selected so that at least.



**Figure 9:** Comparison of different techniques made using decontamination Operations, A) Disturbed image (SNR = 20 Db), RMS = 25.7, B) Wiener filter RMS = 20.2, C) Gauss filter (Sigma = 1.0), RMS = 21.1, D) Kuwahara filter (5\*5), RMS = 22.4, E) Medyan filter RMS = 22.6, F) Morphological operator RMS = 26.2, [14].

### 2.4.3 Finding edge

Thresholding techniques all the pixels belong to the object or the remainder belonging to a partition separating process. Alternatively, a segmentation process is also finding edges, a segmentation technique that allows the presence of pixels determines the boundaries of technical objects. Figure 10 shows the operation carried out by using Sobel gradient edge detection.



**Figure 10:** Sobel edge detection is carried out using gradient operation

## 2.5 Image Processing Application Areas

Modern technology, multidimensional signals from simple to complex circuitry with a number of computer systems enables the processing system.

The aim of treatment:

Image Processing> Enters Image - Image interests

Image Analysis> Enters Image - Measure interests

Image Understanding> Enters Image - Remove defines high-order

Including 3 to separate the categories [15].

## 2.6 Histogram

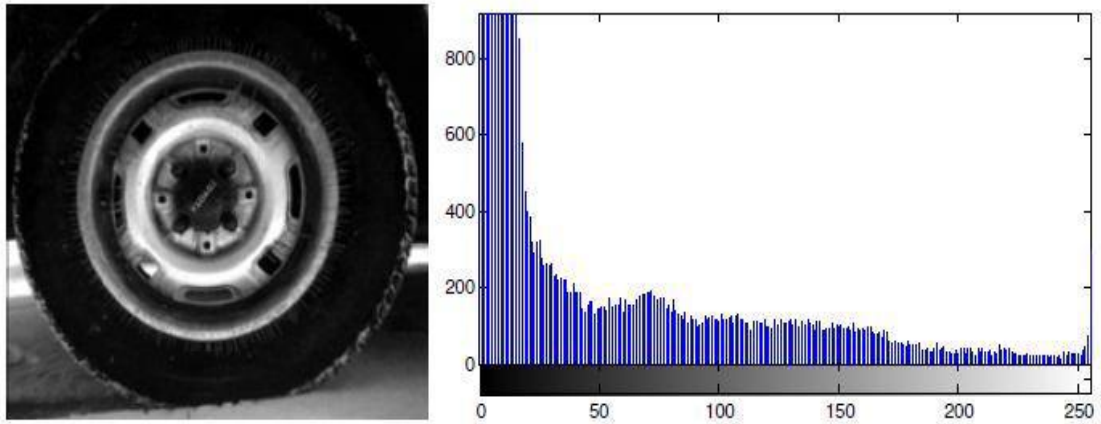
Scalar image and each pixel carries a certain value. First order gray level histogram or histogram shows the distribution of brightness in the image. Called the number of iterations in the image histogram display pixel brightness values. An image histogram the horizontal axis and the vertical axis in the pixel intensity value, i.e. represents the brightness of each pixel in the image.

A scalar image carries a certain value, in pixels. First order gray level histogram or histogram shows the distribution of brightness in the image. If the input image brightness 256 levels assumed by a gray image, each pixel of the image range would be [0, 255].

To obtain a histogram of the image (all pixels to be shifted only images), calculates the number of pixels in each brightness level. A simple histogram pixel spatial information is lost and only the pixel gray values are obtained, that would be a graphical representation indicating the weight of pixel values contained in the image. Histograms in no position information will only frequency information.

The gray levels (0 - 255), it is possible to selectively masking a value related to an image. Gray level histogram of an image is shown in Figure 11 [8].

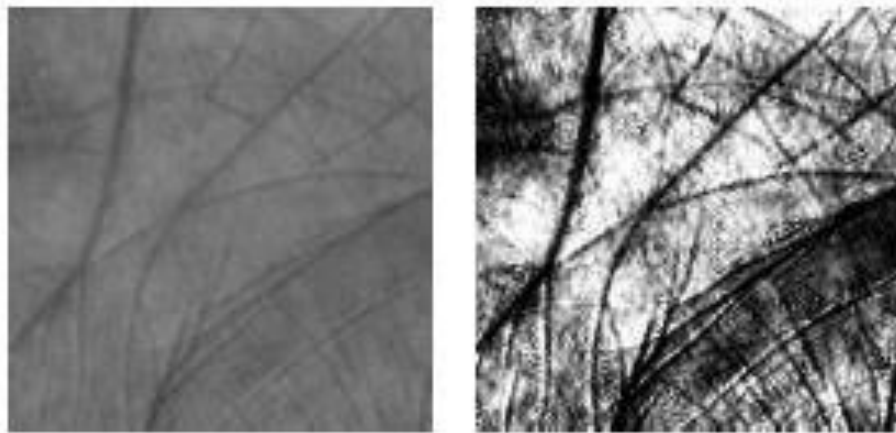




**Figure 11:** Image histogram [16]

### 2.6.1 Histogram thresholding

Histogram equalization is useful for images that do not change the clutter in part in gray level. This format is less contrast in the image and would be processed better after histogram equalization. As can be seen in Figure 12, the purpose of histogram equalization, the frequency of the color histogram accumulation somewhere above is to distribute in accordance with [16].



**Figure 12:** Histogram equalized palmprint image [16]

The left image in Figure 12, while gray level values in the range between (61 - 142) gray levels in the right image after histogram equalization has values between (0 - 255).

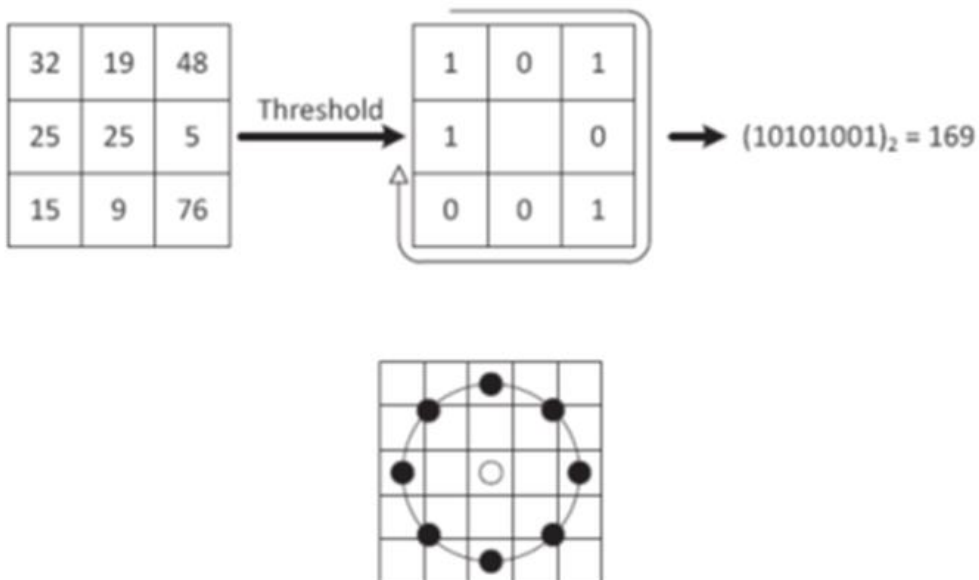
## CHAPTER 3

### FEATURE EXTRACTION METHODS

#### 3.1 Local Binary Patterns (LBP)

The original LBP operator [17] generates an 8-bit binary number by thresholding the pixels in  $3 \times 3$  neighborhoods with the center pixel as shown in Figure 13. The operator was later extended to handle different neighborhood sizes by using circular neighborhoods and bilinear interpolation (Ojala et al., 2002). The recommended notation to describe such a neighborhood is  $(P, R)$ , where  $P$  is the number of sampling points on the circle and  $R$  is the radius of the circle Figure 14.

Figure 15 shows the location of the sampling points in an  $(8, 2)$  neighborhood. The values of non-integer coordinates are computed using bilinear interpolation. Another extension of the LBP operator is the usage of uniform patterns [17].



**Figure 13:** Local binary pattern architecture

Local Window		
18	15	8
21	18	6
27	23	22

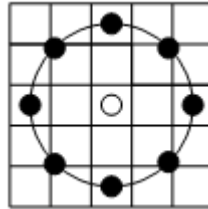
Thresholded		
1	0	0
1	○	0
1	1	1

Weights		
8	4	2
16	○	1
32	64	128

**LBP String = (0001111)**

**LBP Code = 0+0+0+8+16+32+64+128=248**

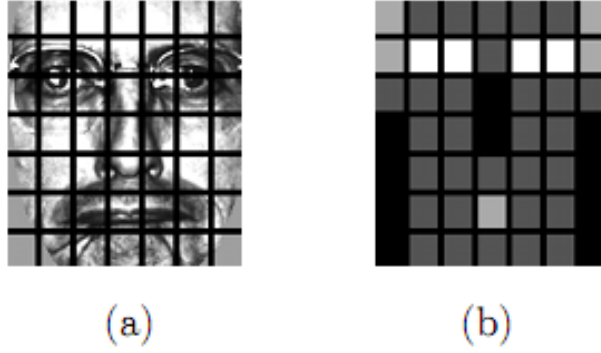
**Figure 14:** The basic LBP operator [17, 18].



**Figure 15:** The circular (8, 2) neighborhood [17].

The following notation is employed for the LBP operator:  $LBP_{P,R}^{u^2}$ , where the subscript denotes the use of the operator in a (P, R) neighborhood, and the superscript  $u^2$  the use of uniform patterns only, categorizing all remaining patterns with a single label.

This histogram provides information regarding the distribution of localized micro-patterns, such as edges, spots and flattened areas, over the total image. Effective face representation also requires the preservation of spatial information. For this purpose, the image is divided into areas  $R_0, R_1, \dots, R_{m-1}$  (Ahonen et al., 2004). The length of the feature vector is thus  $B = mB_r$ , in which m is the number of areas and  $B_r$  is the LBP histogram size. A large number of small areas yields long feature vectors, resulting in high memory usage and slow classification, whereas large areas cause the loss of more spatial information. Figure 16 (a) displays an example of a preprocessed face mask image divided into 49 windows (Ahonen et al., 2004), a similar number to that used in the present study.



**Figure 16:** (a) Example of a preprocessing face mask image divided into 49 windows [18].

One of the best methods with which to represent texture is the LBP technique, which has been widely used in various recent applications. The method is considered one of the most useful for appearance analysis due to good separation/discrimination and other important features, such as invariance in monotonic changes in gray level, and computational efficiency. In this technique, each face is composed of a combination of several small models and thus can be described more precisely.

The local binary pattern method is considered the strongest approach to texture analysis and was initially proposed as a  $3 \times 3$  square operator by Ojala et al. (2002). The operation of this method is similar to that in which 8-neighborhood pixels are compared with the central pixel. If the eight neighboring pixels are greater or equal to the amount of the central pixel, they are replaced by 1; otherwise, their amount is set to zero.

Finally, the central pixel is replaced by summing the weighted binary neighboring pixels, and the  $3 \times 3$  window passes to the next pixel. By constructing a histogram of these amounts, a descriptor for the appearance texture is obtained.

Equation describes the composing relationship of the local binary pattern in each pixel:

$$LBP_{P,R}(x,y) = \sum_{p=0}^{P-1} s(g_p - g_c) 2^p$$

where  $s$  denotes the sign 1, and  $g_p$  and  $g_c$  denote the gray level amount of neighboring and central pixels, respectively.  $2^P$  is a required factor for each neighbor due to the fact that the LBP method involves the use of tissues with different ratios.

### 3.2 The Uniform Local Binary Pattern

The first improvement made to the LBP method was introduced in the form of uniform pattern by Ojala et al. (1996).

If a local binary pattern consists of a maximum of a 2-bit transition from 0 to 1 or vice versa, it is considered uniform. For example, 0000000000 (zero transitions) and 11001001 (4 transitions) are respectively uniform and non-uniform. It has been shown that using the neighborhoods (1, 8) and (16, 2) respectively about 90% and 70% of all patterns produced are uniform.

The overall pattern of a binary with P bits is expressed as  $P+2(P-1)$  in the monotone model. In the  $LBP_{P,R}^{u2}$  notation used for uniform LBP, the lower script indicates the use of neighborhood (P, R) and the superscript indicates the use of only uniform patterns. The uniform binary model is then calculated according to equation as follows:

$$LBP_{P,R}^{u2}(x, y) = \begin{cases} I(LBP_{P,R}(x, y)) & \text{if } \begin{cases} U(LBP_{P,R}) \leq 2 \\ I(z) \in [0, (P-1)P + 2] \end{cases} \\ (p-1)p + 2 & \text{otherwise} \end{cases}$$

Where  $U(x)$  is the detector of the number of transitions between bits, and is defined as in equation:

$$U(LBP_{P,R}) = |s(g_{P-1} - g_c) - s(g_0 - g_c)| + \sum_{P=1}^P |s(g_{P-1} - g_c) - s(g_{P-1} - g_c)|$$

If  $U(x)$  is smaller than 2 pixels, the pixels are labeled with an indicator function  $I(z)$ , otherwise,  $(P-1)P+2$  is assigned. Indicator function index  $I(z)$  includes the  $(P-1)P+2$  which is applied to a specific index for each of the uniform patterns.

### 3.3 Appearance Histogram

In a scalar appearance, image pixels have specific amounts. The first gray level histogram represents the brightness distribution in the image. The horizontal axis of this histogram contains the pixel brightness values, and the vertical axis the number of corresponding pixels with each appearance brightness value. Suppose that the input image is a gray image with 256 levels of brightness, so each image pixel can range in value from 0 to 255.

To obtain the appearance histogram, it is sufficient that in traversing all the pixels in the image we calculate the number of pixels at each brightness level.

It is clear that in a simple histogram, all pixel location information is missing and just the gray values are calculated.

### 3.4 Evaluating and Choosing a Distance Function in System Performance

There are two solutions required to calculate the similarity between feature vectors. The first involves calculating the distance between two feature vectors, and the second calculating the similarity. These two measurements oppose each other. Different criteria are employed to evaluate distance and similarity.

In the present paper, the similarity between a test image  $S$  and a training image  $T$  was determined via the chi-square distance (Li et al., 2007), expressed as follows:

$$D(S, T) = \sum_{n=1}^N \frac{(S_n - T_n)^2}{(S_n + T_n)}$$

A minimum of (1) and maximum of (4) face images of each of the selected test subjects were used in the training.

As is clear, the PCA method produces the worst results, whereas the standard LBP method is the most accurate. However, the currently proposed method has a higher accuracy than standard LBP.

Performance-based approaches appear to be strongly influenced by the number of training images employed. In a further experiment we therefore investigated the influence of this parameter on the proposed method, using a minimum and maximum of (3) images of each test subject for training. Experiments were performed on the database, and the results presented using different algorithms.

### **3.5 Wavelet Theory**

#### **3.5.1 Wavelet transform**

Image processing until the late 1950s, although the mainstay Fourier transforms, wavelet transform, image processing, i.e. compression, expansion and analyzes making it easier. While the Fourier transform of simple sine and cosine functions are based on small waves in the wavelet transform variable frequency and time limit. This is called wavelets to small waves. In addition to providing information on traditional Fourier transform redundancy, temporal information is lost in the transformation operation. Wavelet series is a method used in many different places and including applied mathematics, signal processing systems, audio and video compression systems are some of the most important. Jean Morlet wavelet first and A. Geographic technology has been applied for by Grossman.

The first is based on the use of wavelet and its Fourier transform Joseph Fourier. 1807 after the emergence of the Fourier equation mathematicians began to work for the recognition of signals in the frequency domain. Wavelets first "Haar wavelet" was seen in the so called Haarde's thesis. Esteban and Galand in 1977, put forward the concept of a new filter, but the error was very high in the recovery of the main signal in this way. Wavelet term was first used in 1984 by Morlet and quantum physics work Grossman. In 1987, he revealed the relationship between Mallat wavelet and filter groups.

Meyer threw out the first wavelets bears his name. In contrast to these Haar wavelet has a function that can be used in continuous application. Years later, Ingrid Daubechies has established the basis for many applications, posing for a team steep wavelet-based series today. By definition, a wavelet, with a mean value of zero and a

time wave shape is limited. Scroll in the time axis and form the basis of wavelet scaling parameters.

Image pyramid: The original vision of the machine and is designed for image compression applications. The sum of the images in the sequence of decreasing the image resolution is called a pyramid shape of the pyramid. At the bottom of the pyramid are high-resolution images to be processed, there is a low-resolution images on the hill. When you climb up the pyramid and size, as well as the resolution decreases. The bottom image is the original image. Entered the official low-resolution approach are calculated. Applying interpolation filter input image is determined by how accurately estimated. Generally, the low resolution pyramid levels are used to analyze the whole image [14]. Sub-band coding the images can be divided into smaller parts, called the band took to the small parts. Then combine these sub-bands can reproduce the picture correctly and developed for speech and image compression. Each image sub-bands through the low-pass filter is produced. Bandwidth of the resulting sub-bands which are smaller than the original image. Old bands can be done without loss of information down the sampling process. This process is removed to reduce the image size of the pixels in the image. Up sampling of itself by collecting sub band filtering process and completed the reconstruction of the original image. Up sampling process; To enlarge the image pixels of a digital image is added [19].

### 3.5.2 Continuous wavelet transform

A base wavelet  $\psi(\tau, p)$  generated by orthogonal basis functions have regard represents the continuous wavelet transform signals. A continuous time signal  $f(t)$  administered, wavelet transform is calculated as equation [20].

$$C_x \tau, s = \frac{1}{s} \int f(t) \psi \left( \frac{t - \tau}{s} \right) dt$$

Parameter  $\tau$  is the transformation parameters corresponding to the removal of the signal through the window function at each step and  $S$  is the scale parameter



representing the base wavelet function scale of the window during the transformation [20].

### 3.5.3 Discrete wavelet transform

Discrete wavelet transform, the wavelet series expansion of the function may be considered as an extension of the discrete plane. Used in the series expansion in the discrete plane basic functions and  $f(x)$  function, this functions is obtained by a finite number can be represented by the sampled points. In this case,  $f(x)$  discrete wavelet transform coefficients of the discrete function will be equal to equation [20].

$$W_{\varphi} j_0, k = \frac{1}{M} \int_x f(x) \varphi_{j_0, k}(x)$$

### 3.5.4 Fast wavelet transform

Fast wavelet transform allows for the efficient calculation of the discrete wavelet transform. Fast wavelet transform as shown in Figure 17 is similar to the two-band sub-band coding.

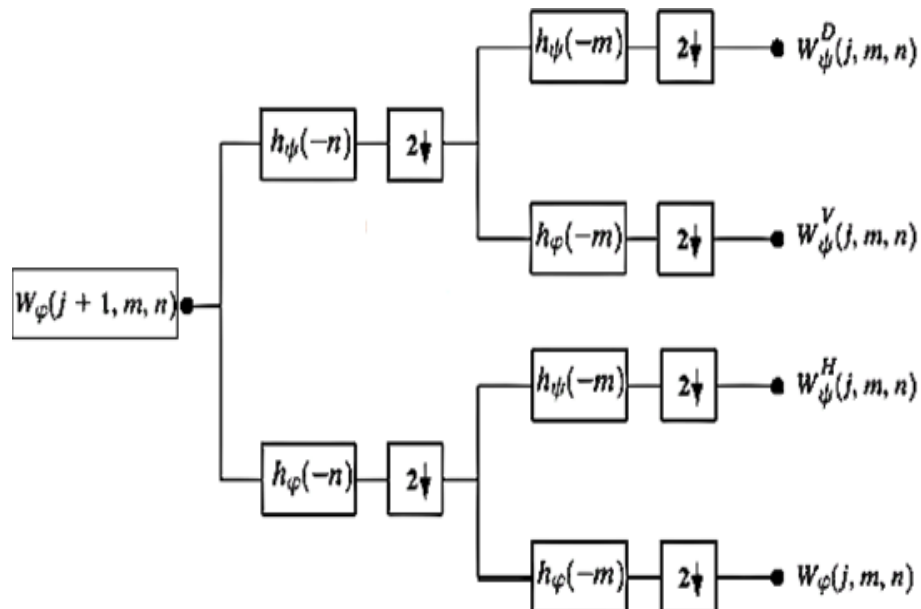


Figure 17: Two-dimensional analysis filter bank [21]

Resolution of an entry point to the (j + 1) implementing and achieving (4) sub-band image is shown in the results.

### 3.5.5 Discrete cosine transform

Discrete cosine transform (DCT - Discrete Cosine Transform) [22] is proposed, the basis for many image compression algorithm. One of the advantages is the absence DFT by DCT should be worked on complex numbers. Look ahead DCT equation is given in the statement.

$$H_{u,v} = \frac{2}{MN} C_u C(v) \sum_{x=0}^{M-1} \sum_{y=0}^{N-1} h_{x,y} \cos \frac{2x+1u\pi}{2M} \cos \frac{2y+1v\pi}{2N}$$

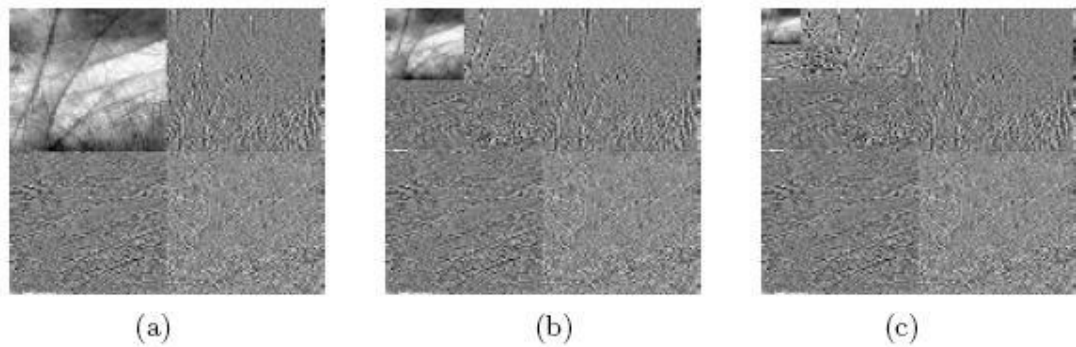
The opposite directions DCT is given by equation.

$$h_{x,y} = \frac{2}{MN} \sum_{u=0}^{M-1} \sum_{v=0}^{N-1} C_u C(v) H_{u,v} \cos \frac{2x+1u\pi}{2M} \cos \frac{2y+1v\pi}{2N}$$

$$C_\gamma = \begin{cases} \frac{1}{2}, & \gamma=0 \\ 1, & \gamma>0 \end{cases}$$

With basic functions such as images DCT can be decomposed into a set of Fourier series. This means that the image can be generated by addition of suitable basic functions [23]. The images we obtain the attributes decomposition methods FFT, DCT, orthogonal wavelet transform and Gabor wavelet transform is applied. 2-D FFT and 2-D DCT with transform has switched to leave the spatial frequency dimension size. FFT implementation in of 3×3 small and 16×16 large coefficients were screened against falling frequencies. In 32×32 large areas of the DCT eliminating low frequency information is used. The goal here, can be considered as noise, recognition will be given to the removal of unnecessary information and feature extraction algorithm is to reduce the data size. Provide strong localized frequency information, multi-resolution decomposition technique, the discrete wavelet transform (DWT), was applied using different basic functions. Haar, Daubechies-4, Daubechies-8 and Coiflet-6 basic functions were compared in the first

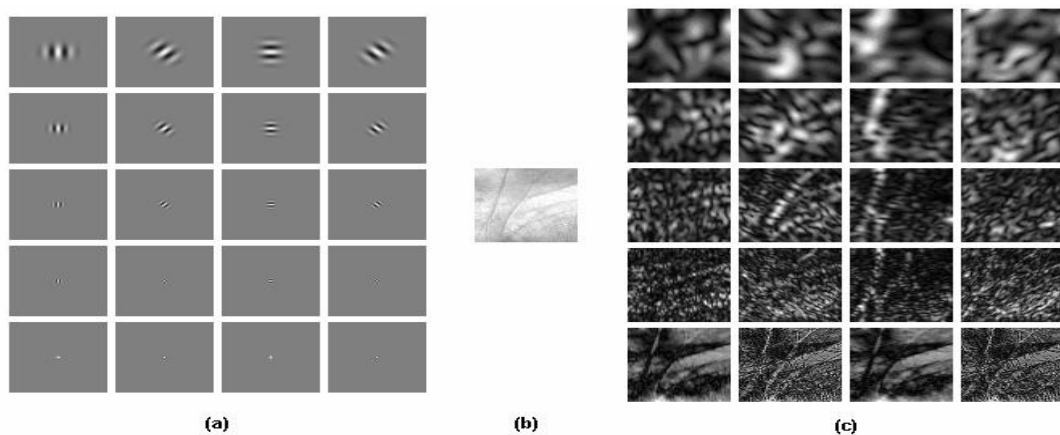
database, in the subsequent test results that the optimal D-4 filter is used. Discrete wavelet transform was used for applying the filter bank approach in terms of speed and convenience. Figure 18 example illustrates the application of a Palmprint image in the wavelet transform.



**Figure 18:** Palmprint images in different wavelet sub-band words

- (a) The First Level Wavelet Decomposition
- (b) The Second Level Wavelet Decomposition
- (c) The Third Level Wavelet Decomposition

On Gabor wavelets method, Gabor kernel is folded with the image of different adaptation and scale. Here, Gabor wavelet method [24] was applied. 5 scales and 4 orientations (compliance) is used. The size of the magnification image of Gabor wavelets (image height  $\times$  adjustment  $\times$  scale) because the images were reduced by half. Filter design in the DC component is removed. Thus gloss uniformity has been achieved. The high and low frequency bands used in the Gabor filter are determined by the experimental results. An example implementation in the Palmprint of Gabor wavelets is given in figure 19.



**Figure 19:** An Example implementation in the palmprint of gabor wavelets

- (a) The Real Component of the Applied Gabor Wavelets
- (b) Representative Image of a Palmprint
- (c) The Amplitude of the Filtered Palmprint Images

### **3.6 Summary of Previous Work Related of Palmprint**

Palmprint trail using the features identification and authentication are among the problems still awaiting solution today. Studies have been developed in various ways. Generally, methods such as fingerprint recognition Palmprints on Gabor filters, wavelet transforms, Fourier transform is performed using methods.

Palmprints compared with the fingerprint has too many lines and shows higher performance compared to the fingerprint recognition. Even when you do not need it in the Palmprint of tracks needed for high-resolution fingerprint, recognition occurs easily at low resolution. Extraction attributes person in the literature have used the wavelet transform and neural network classification. Yu in 2008, Palmprint recognition approach for the study a Modified Discrete Cosine Transform based feature is used to obtain the Palmprint features with the extraction method. Radial-based classification using artificial neural networks. Radial basis neural network to facilitate education, more data was also used to reduce to a reasonable size [25].

Lu in 2008, studies primarily Palmprint of the two-dimensional discrete wavelet transform, and then Principal Component Analysis (PCA) is applied. It then uses the local projection method to reduce the size of protection. Finally, classification Palmprint images are forced to classification quickly with artificial neural networks [26].

Ekinci, 2008, to separate the Palmprint image in low resolution for daubechies wavelet sub-band coefficients are separated by wavelets. Then kernel principal component analysis (PCA) at sub-band by the method is applied to extract the non-linear coefficients. Finally, the artificial neural network to classify the linear weighted Euclidean distance to measure the similarity and support vector machine (SVM) is conducted with a comparison [27].

Kong in 2007, biometrics-based authentication and wavelet transform as an effective approach for identification and Zernike Moment with Palmprint techniques are used

to extract the texture features. In determining the characteristics stage means clustering algorithm is used. Backpropagation neural networks are used in the classification phase [28].

Wavelet in 2007, transform is used to extract Wong Palmprints line the headlamps to resolution levels. The low level of resolution, the Palmprint is extracted fine lines. High-resolution level, Palmprints rough lines are extracted. Right hand display 100 different individuals were used. Is pretreated to find images of the key points of Palmprints. Looking at the key point is rotated and cropped images. Palmprint is enhanced and resized images. Two different wavelet energy level is used. This feature vectors Euclidean distance or classified using feedforward backpropagation neural network and tested. According to the results, 99.07% accuracy DB 5 types of wavelet and wavelet energy level is obtained using 2 [29].

Gabor wavelet networks offer advantages in studies in 2006 and probabilistic have used artificial neural networks. First, the Palmprints of each individual's Gabor wavelet network feature vectors. They are trained by probabilistic neural network.

Correct identification rate reaches 99.5% in the experiments. Algorithm efficiency in an image database containing 1971, examples proved [30].

Zhou in 2006, palmprint with low sub-band images with images of two dimensional and 3-band discrete wavelet transform has interests feature vectors. Support vector machines in classification phase (SVM) prefer. The recognition rate is 100% correct identification of the experimental results [31].

Wen in 2005 in this study, to improve clarity and continuity of the Palmprint has proposed a new Palmprint enhancement algorithm. Experimental results indicate that an effective low-quality fingerprint images [32].

Han 2003, identification system; It consists of two stages, including enrollment and verification. During the registration process, training samples were collected and preprocessing, feature extraction and modeling templates are created with the parts.

In the validation phase, a query sample is also processed by the pre-processing and feature extraction module, and then matched with the reference templates to decide whether this is a real example. Working area for each sample is obtained by the preprocessing module. Then, palmprint features Sobel method and obtained using

morphological operations. Finally, the template matching and radiated back in the validation phase is used to measure the similarity of artificial neural network [33].

Wu 2002, wavelet energy features named a new Palmprint property is used as a powerful tool for multiresolution wavelet analysis. In this study, different levels of wavelet decomposition in various aspects of the main lines, wrinkles and ridges may reflect the wavelet energy distribution, Palmprints distinctiveness in them is very high [34].

In 1998, Funai images fluffy thick lines and thin line wrinkles. It is not possible to extract the fingerprint feature extraction algorithms with thick lines. This research offers a new feature extraction method to extract the thick lines under these conditions [35].

### **3.7 Palmprint People Based Recognition**

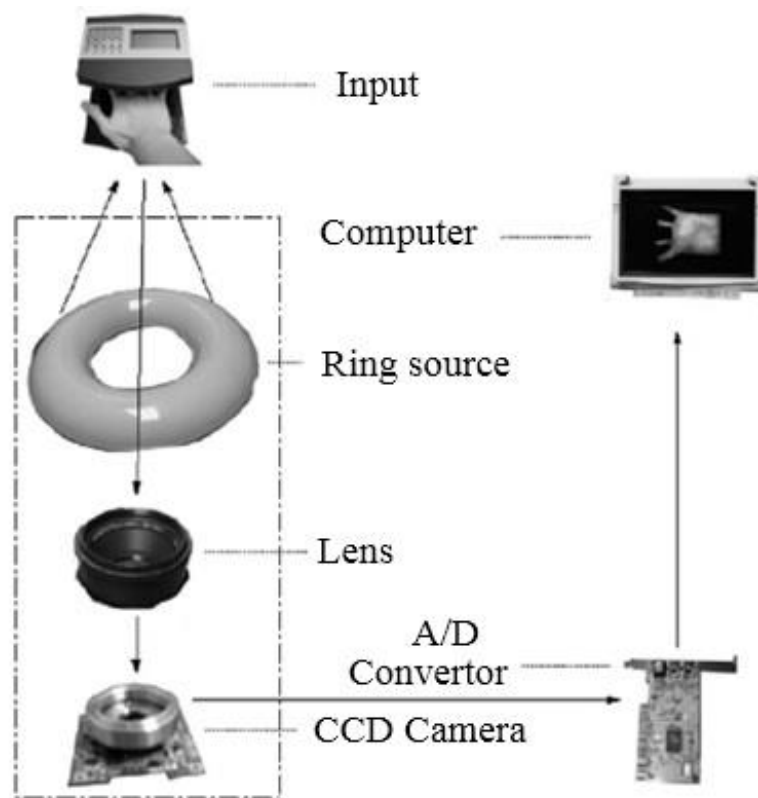
Be distinguished based on the Palmprint of people in recent years has the researchers to effectively take care of one of the issues. Based on structural and appearance on this subject [30, 31] have been proposed various approaches. Structural approaches to take advantage of the various features in an image or remove the problem attributes. The appearance-based approaches to treating it as a whole uses the same algorithm to image all problems. The performance of the proposed method, the poly-UI and poly-UII [36] were evaluated on Palmprint databases.

Poly-UI palmprint images in the database was extracted using a CCD camera. The database contains 600 images from 100 different Palmprints. 6 for example, a Palmprint from each of the first three sessions, while the other three were in another session [30].

Time between the second session with the first session is approximately two months. Poly-UII is a Palmprint images in the database were also obtained analogously. 7752 number of images in the database are taken from 386 various Palmprints. Every first session of a handful of 10, there are 10 images in the second session. The interval between two sessions is 69 days. All images in 384 \* 284 size were obtained with a resolution of 75 dpi. Also, the light source and changing the focus setting of the first CCD camera.

And the second session of the images has been taken in the sense that a palmprint taken from different devices. palmprint track image capture system in a stable palmprint track to achieve the image, semi-closed environment in order to create a box and a cover.

A ring is also used to ensure that changes in the Palmprint images taken by light conditions. Six hooks that serve as checkpoints on the platform, providing the proper placement of the user's hand. A/D converter was taken by a CCD camera transmits images directly to the computer. Figure 20 shows the schematic diagram of the Palmprint image generating system.



**Figure 20:** The design principle of a palmprint capture system [31]

## CHAPTER 4

### IDENTIFICATION BY THE PALMPRINT USING A LOCAL BINARY PATTERN

#### 4.1 Background

Biometrics is a unique and measurable feature for identification. Biometric systems are divided into two categories: identification and verification. The first category's aim is recognizing the identification of the individual among the others in the database. In such systems, to the question "who am I?" will answer. In the second, the person offers his identity and the aim of the system is the confirming this identification and in the systems, to the question "do what I say I am?" will answer [37].

It is clear that any biometric identification system is not the absolutely best solution for identification. By international biometric group, an interesting comparison is done between different systems based on four parametric, distinctiveness, and cost of identification system, time and spending effort by the user in the identification and the rate of user's comfort during identification [38].

An ideal biometric system is a system in which contains all four enumerated parameters in the farthest place according to the center of the diagram [39].

In another study has gained the highest percentage compatibility by taking six biometric techniques (face, fingerprint, hand geometry, voice, eyes and signature) with machine readable travel documents (MRTD), facial features. In this study, parameters such as registration, refreshment, hardware requirement and public acceptance is considered. Palmprint recognition system is a biometric system using intelligent automatic methods to identify or verify the identification of a person based on physiological characteristics. In the past two decades, the matter of identifying of Palmprints is the extensive research field of machine's vision and



pattern recognition. One of the extensive applications for recognition of Palmprint lines is the field of security and verification. In controlling the high population areas, such as airports, railway stations, and subway and ..., this method is more effective than other methods of surveillance. So several photographs have taken from the lines in the Palmprints of people and the device must be able to identify these people at different times, in different orientations of light and.

Current methods of identification Palmprints use of four types of Palmprints features: texture, lines, appearance and orientation. According to the extracted features are divided into five categories [5]:

- 1- Texture based methods which using the filters such as Gabor, discrete Fourier, Wavelet and Rydan.
- 2- Line based methods are like identifier of Palmprints directed lines, sober performance, multi-resolution filters and Rydan filter.
- 3- Appearance based methods are that uses from the analyzing of principal component, analysis of linear distinct appearance of local guard and analyzing of kernel principal component.
- 4- Orientation based methods, which usually uses the Gabor filters.
- 5- Multi feature based method, such as the combination of features of Palmprints lines and filed in a same vector. Typically, combinations are done in four levels, data feature, matching, and the decision.

Combination methods in the features level are divided into four categories: series combination, parallel combination, weight combination, and core based combination [5].

In order to identification by a person's Palmprint lines, the lines must be properly extracted. One way to define these lines are using different methods of edge detection. Sobel edge detection and Morphological operation is used in [40].

In this paper, for the complete extraction of useful features from an appearance, a simple but powerful method an uniform local binary pattern to identification of Palmprints are expressed because this method can pull out all the useful information of an appearance.

In [42], a Consistent Orientation Pattern (COP) hashing method to enforce fast search is proposed. Using the orientation and response features extracted by steerable

filter, first given an analysis on the consistency of orientation features, and then a method used to construct COP using the consistent features. The COP is very stable across the samples of the same subject, the COP hashing method can find the target template quickly and thus can lead to early termination of the searching process.

In [43], an ultrasound technique for extracting 3D Palmprints is experimentally evaluated. A commercial ultrasound imaging machine, provided with a high frequency (12 MHz) linear array, is employed for the experiments.

The probe is moved in the elevation direction by a motorized stepper stage and at each step a B-scan is acquired and stored to form a 3D matrix representing the under skin volume. The data from the 3D matrix are elaborated to provide several renderings of the 3D ultrasonic Palmprint.

## **4.2 Local Binary Pattern (LBP)**

One of the best ways to represent texture is LBP technique, which is widely used in various applications in the recent years. Approval of good separation and important features such as invariance in monotonic changes of gray level and computational efficiency cause to made this method as one of the most useful methods for appearance analysis. Palmprint is composed of a combination of several small models so by this method it can be described so well.

### **4.2.1 Description of the local binary pattern**

The local binary pattern is considered as the strong approach to texture analysis. For the first time, it was proposed as square operator  $3 \times 3$  by Ojala and his co-workers [45].

The operation of this method is like which 8-neighborhood on operator are comparing with the central pixel. If each of the eight neighboring pixels will be greater or equal to the amount of the central pixel will be replaced by 1 and otherwise, their amount will be zero. At last, the central pixel is replaced by summing weighted binary neighboring pixels and  $3 \times 3$  window will pass to the next

pixel. By getting histogram of these amounts, a descriptor for appearance texture is obtained.

And the equation shows the composing relationship of local binary pattern in each pixel:

$$LBP_{P,R}(x,y) = \sum_{p=0}^{P-1} s(g_p - g_c) 2^p$$

Which  $s$  denotes the sign 1,  $g_p$  and  $g_c$ , denotes the amount of the gray levels of neighboring and central pixels. Also  $2^p$  is a required factor for each neighbor because LBP method contains tissues with different ratios.

#### 4.2.2 The uniform local binary pattern

The first improvement of the LBP was introduced as uniform pattern in 2000 [46]. If a local binary pattern consists of a maximum of 2-bit transition from (0) to 1 or vice versa is called uniform. For example 0000000000 patterns (0 transition) and 11001001 (4 transitions) are respectively the uniform and non-uniform. It has been shown that using the neighborhood (1, 8) and (16, 2) respectively are about 90% and 70% of entire pattern. The overall pattern of binary with P bits consists of P + 2 (P-1) of monotone model. From LBP  $(\substack{u \\ P,R})$  notations has been using for LBD uniform which below script express use of neighborhood (P,R) and the superscript indicates the using of uniform pattern .Uniform binary model according to equation is calculated.

$$LBP_{P,R}^{U2}(x,y) = \begin{cases} I(LBP_{P,R}(x,y)) & \text{if } \begin{cases} U(LBP_{P,R}) \leq 2 \\ I(z) \in [0, (P-1)P + 2] \end{cases} \\ (p-1)p + 2 & \text{otherwise} \end{cases}$$

That U (x) is the detonator of the number of transitions between bits, and is defined like equation:

$$U(LBP_{P,R}) = |s(g_{P-1} - g_c) - s(g_0 - g_c)| + \sum_{p=1}^P |s(g_{p-1} - g_c) - s(g_p - g_c)|$$

If  $U(x)$  is smaller than 2 pixels, the currently pixels labeled with an indicator function  $I(z)$ , otherwise, the  $(P-1)P + 2$  will assigned to it. Indicator function index  $I(z)$  which includes the  $(P-1)P + 2$  which is applied for specific index for to each of the uniform patterns.

### 4.3 Histogram of Appearance

In a scalar appearance, the image pixels have specific amounts. First gray level histogram or histogram shows how the brightness distribution is in the image. In fact the graphical representation of the pixel brightness values against the number of occurrences in the entire image is called histogram. The horizontal axis of a histogram, the pixel brightness values of the appearance and its vertical axis represents the number of corresponding pixels to each value of the brightness of the appearance. Suppose that the input image is a gray image with 256 levels of brightness, so each image pixel can have range in value (0 255). To getting the appearance histogram, it is sufficient that with traversing all the pixels of the image, we calculate the number of pixels of each brightness level.

It is clear that in a simple histogram, all of the pixel locations information is missing and just amount of gray values are calculated.

### 4.4 Co-occurrence Matrix

Second-order histogram which in some references known as co-occurrence matrix, express the event rates of gray values of the two pixels which depends on the distance of image and special direction of each other.

For the first time the co-occurrence matrix have been used to extract textural features of the image in order to troubleshoot of grapefruit by Harlyk [47]. Co-occurrence matrix is the description of the frequency of  $P_{ij}$  which the two separated neighboring pixels by a fixed distance  $d$  that one of them with gray intensity  $I$  and other with gray intensity  $J$  occurs in image. So the co-occurrence matrix from a square matrix whose size depends on the maximum pixel intensity in gray image is to be formed. Each

element of  $P_{ij}$  representative of the number of occurrences pixel size I of the pixel distance from pixel size j , and usually is equal to 1 (d=1), and the angle between two pixels may represent by 0, 45, 90 and 135 degrees [48].

The result of the co-occurrence matrix shows that how the pixel values of the image are closer to each other, the larger diameter of the core matrix of aggregate. The advantage of using this matrix on simple histogram of the image with compared to a simple histogram is in which the spatial information of pixels has destroyed and just amount of gray pixels are calculated in this matrix location of pixels. So that the distribution of gray values is larger, there is more variance in the matrix.

In the mathematical definition of a co-occurrence matrix  $C_d$  for matrix with a distance  $(\Delta x, \Delta y)$  is defined as an equation:

$$C_k(i, j) = \sum_{p=1}^n \sum_{q=1}^m \begin{cases} 1, & \text{if } I(p, q) = i \text{ and } I(p + \Delta x, q + \Delta y) = j \\ 0, & \text{otherwise} \end{cases}$$

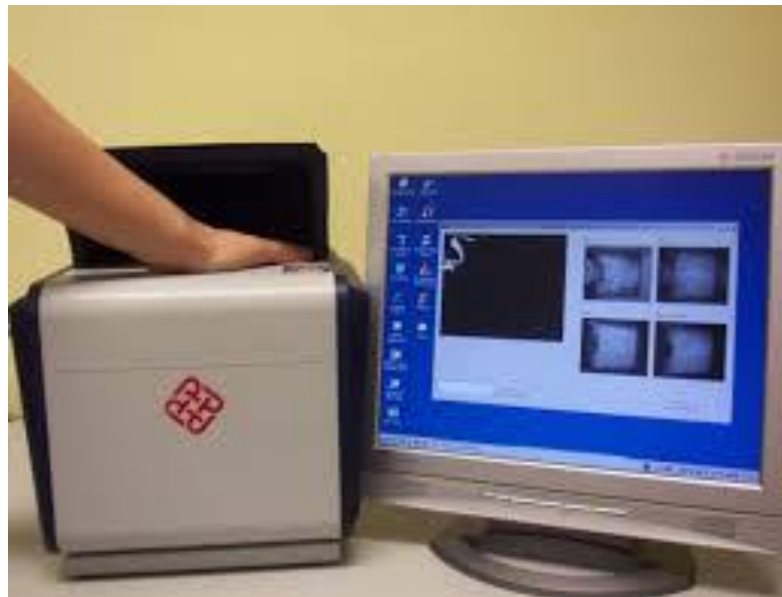
The (i,j) elements of  $C_d$  matrix are the number of appearance of i and j which have distinct in size  $(\Delta x, \Delta y)$  with each other. In fact co-occurrence matrix is based on the estimation of second rate which is conditional of the density function 1. Second order statistical properties define the overall picture as well [49].

For example, shows the co-occurrence matrix to the matrix dates in that is calculate in direction of zero and with neighborhood of 1. Since natural images usually have low-pass features and adjacent pixels are highly correlated, co-occurrences matrix of pixels or their diagonal coefficients are distributed. In other words, the values are large amounts of numbers on the main diagonal and gradually will reduce minor diameters. After insertion due to the loss of correlation, the focus on the main diagonal of co-occurrence matrix be reduced and cause distribution.

#### 4.5 Appearance Database

The databases of images that used in this article, is part of the image database which is collected at Hong Kong Polytechnic University. A device that is used for taking pictures is scanner which is based on CCD camera. The size of images is 384×284

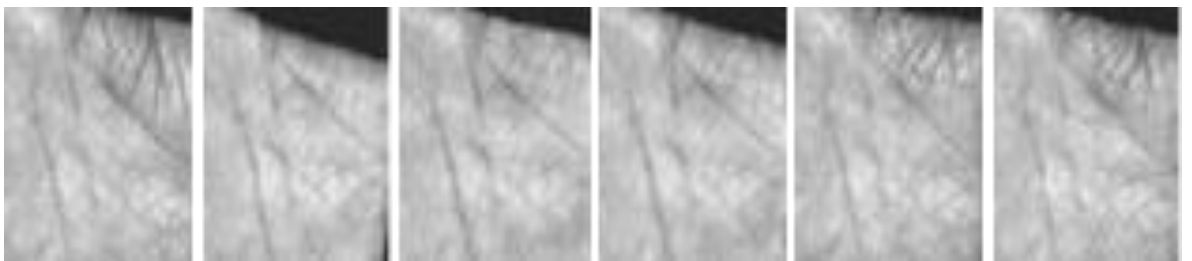
pixels with 750 dpi resolution. Figure 21 shows the image acquisition device and the sample images which is captured by it [50].



**Figure 21:** Image acquisition device and the sample images which is captured by it.

To evaluate the proposed method, a number of image from this databases are selected these image due to skin pigmentation and the small difference between levels of gray lines and other areas; they have different levels of brightness.

The size of the original images is  $384 \times 284$ . After preprocessing, the central part of the image (size is  $128 \times 128$ ), is cropped for feature extraction and matching. Figure 22 shows some samples of one Palmprint after preprocessing.



**Figure 22:** Some samples of one palmprint after preprocessing

## 4.6 The Simulation Results

Evaluations were done on a standard database of Palmprints of Polytechnic University of Hong Kong Poly palmprint. Dataset included the 6000 picture of palmprints of 500 person which is included in the approximately there are 12 available images from per person.

### 4.6.1 Evaluating and choosing a distance function in system performance

There are two solutions for calculating the similarity between feature vectors. Ones calculate the distance between two feature vectors, and second, calculate the similarity. These two measurements are against each other. There are different criteria to evaluate the distance and similarity, that in this paper, the similarity between test image  $S$  and the training image  $T$  we used chi-square distance [51].

It is expressed as Equation:

$$D(S, T) = \sum_{n=1}^N \frac{(S_n - T_n)^2}{(S_n + T_n)}$$

Minimum 1 and maximum 4 images in the Palmprint of our test subjects got used to the training.

Experiments were performed on the database, Table 1 shows the obtained results.

As it is clear, the PCA method among other methods has the worst result, and LBP standard method has higher accuracy than other remaining methods. The proposed method has higher accuracy than the LBP standard.

Performance-based approaches which appear strongly have been influenced by the number of training images. So in the third experiment, we investigated the influence of this parameter on our method. In this experiment we used minimum and maximum of 4 images of per person to train ourselves. Experiments were performed on the database, and the results are presented on different algorithms. In table 1, the results show that the proposed method among the other training sample methods has better performance.

											Identify Methods
Image 11	Image 10	Image 9	Image 8	Image 7	Image 6	Image 5	Image 4	Image 3	Image 2	Image 1	Number Of Training Images
65	65	60	45	85	83	80	75	55	50	50	PCA
80	90	80	85	80	90	100	100	100	90	100	LBP Hist Co-occu U2 8
75	80	85	85	70	75	95	95	100	90	100	LBP Hist Co-occu U2 16
70	85	75	80	65	80	95	90	100	75	100	LBP Hist Co-occu U2 24
50	75	60	75	65	65	75	80	95	80	100	LBP Hist Co-occu Ri 8
80	75	85	80	65	65	90	100	100	85	100	LBP Hist Co-occu Ri 16
75	65	60	70	65	60	90	85	90	80	100	LBP Hist Co-occu Ri24
75	75	65	65	60	70	90	80	95	80	100	LBP Hist Co-occu Riu2 8
70	70	75	70	65	60	90	95	100	80	100	LBP Hist Co-occu Riu2 16
70	75	80	65	65	60	95	95	100	80	100	LBP Hist Co-occu Riu2 24

**Table 1:** Comparing the Results of Proposed System with Other Procedures Performed on the Database



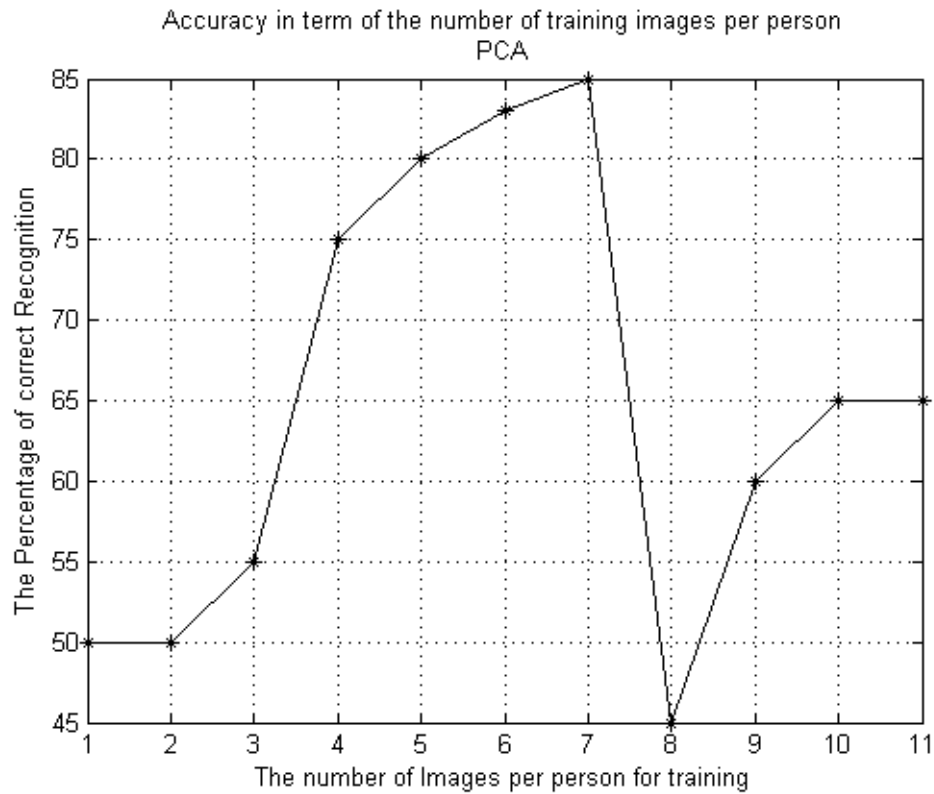
In our experiments the number of training images for one of the database has changed from 1 to 4, and the last photo is selected for testing. This experiment was performed 20 times in each stage.

The obtained average values are recorded. In Figure 26, the change in accuracy percentage terms of the training number images is shown.

#### **4.7 Experimental Results**

Experiments were conducted to demonstrate the performance of the proposed approach. Our algorithm was validated on Palmprint images. The proposed recognition method outlined for Palmprint images were implemented using the Matlab programming language and run on a PC with an Intel, Duo CPU 2.00 GHz, 2.00 GB of RAM and yielded the results in the figure 23, 24 and table 1. In the experiment, we selected the samples from the first session for training, and the samples from the second session for testing.

Thus, the total number of training samples and test images are both 300. Table 1 shows the recognition accuracy of different methods. From Table 1, several findings could be found. First, proposed LBP method is an effective method; no less than 4% improvement could be gotten by multiscale scheme. Second, as more information could be extracted, the proposed method could get better result than traditionally multiscale method. Finally, the proposed method could get better result than learning based methods, PCA.



**Figure 23:** The changes in accuracy percentage terms of the training number images each person

As can be seen, the proposed method is highly dependent on the number of training images and accuracy of about a few percent increase in the number of images increases from (1) to (11) are visible.

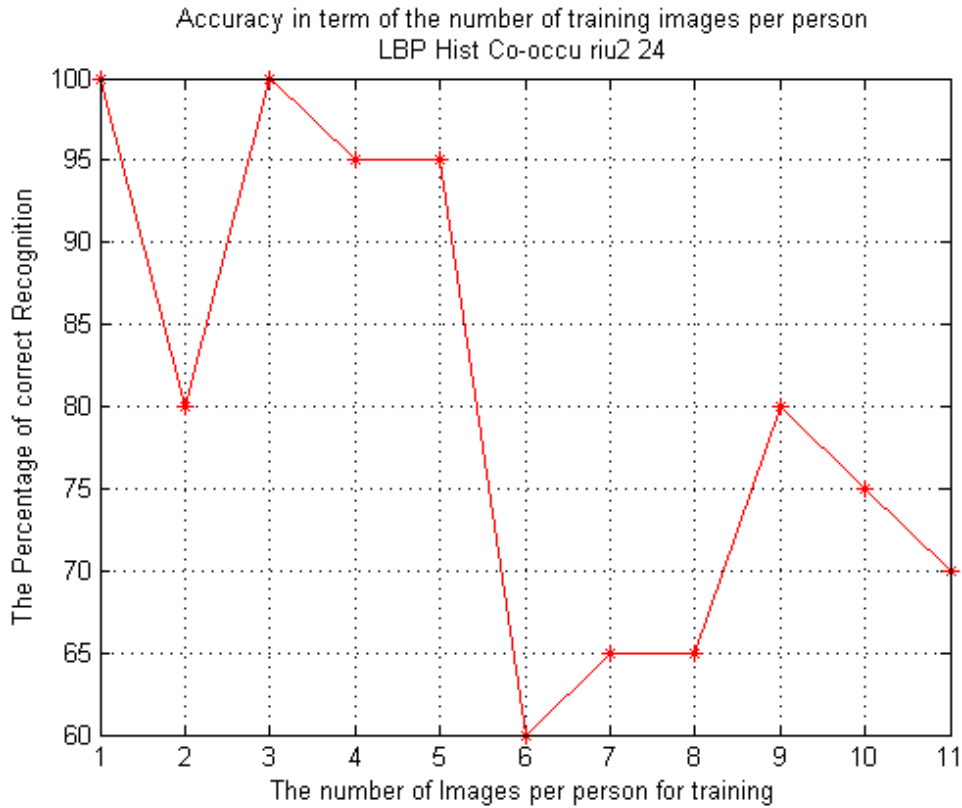
PCA one of the most successful techniques that have been used in image recognition and image compression. PCA is classified as a statistical method in this area.

The main goal in the PCA methods reducing the large dimensions of data space to the dimensions of the smaller spaces.

PCA is methods that calculate a dataset to a new coordinate system by determining the eigenvectors and eigenvalues of a matrix. It involves a calculation of a covariance matrix of a dataset to minimize the redundancy and maximize the variance.

Figure 23 show the percentage of palmprint recognition with PCA algorithm. As you see the maximum percentage is (85) and get in (7) image.

Figure 24 shows the effects of training image on recognition accuracy and precision of each method.



**Figure 24:** Rotational invariant uniform  $R = 3, P = 24$

For Rotational Invariant Uniform we have:

$$\text{LBP}_{P,R}^{\text{riu2}} = \begin{cases} \sum_{i=0}^{P-1} s(p_i - p_c) & \text{if } U(\text{LBP}_{P,R}) \leq 2 \\ P + 1 & \text{otherwise} \end{cases},$$

This figure show the percentage of palmprint recognition with riu2 (24) LBP algorithm. As you see the maximum percentage is (100) and get when we select (1) and (3) image for testing.

Figure 25 show the percentage of palmprint recognition with riu2 (16) LBP algorithm. as you see the maximum percentage is (100) and get when we select (1) and (3) image for testing. The minimum percentage is get when we select 6 image this percentage is (60).



**Figure 25:** Rotational invariant uniform  $R = 2$ ,  $p = 16$

Figure 26 show the percentage of palmprint recognition with riu2 (8) LBP algorithm. As you see the maximum percentage is (100) and get when we select 1 image for testing. The minimum percentage is get when we select (7) image this percentage is (60).

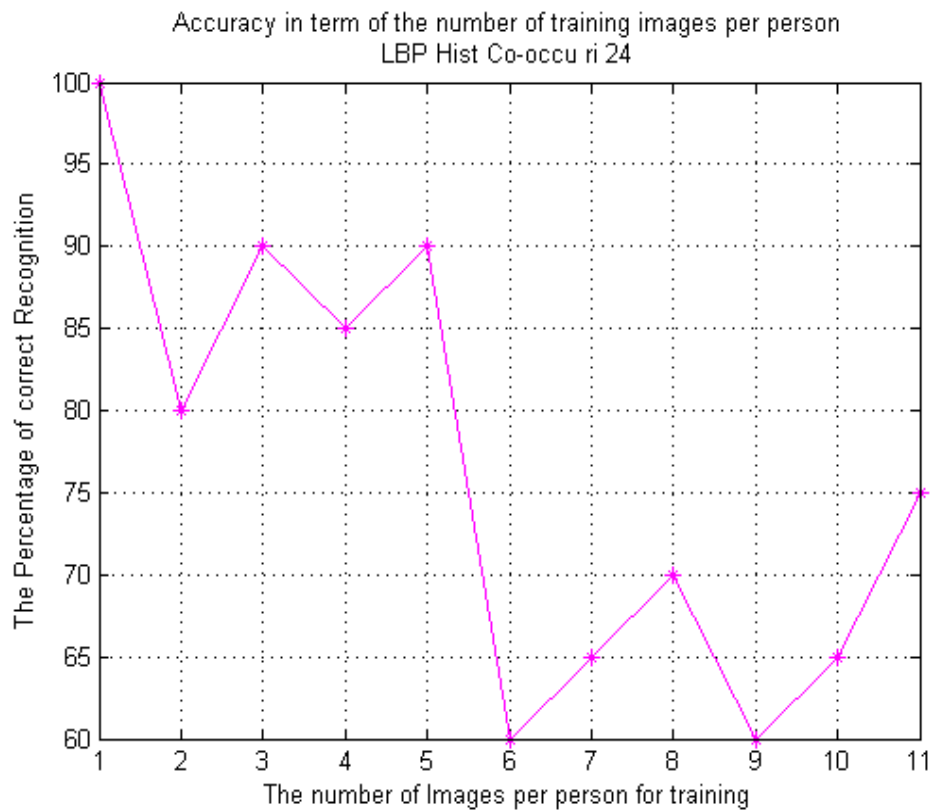


**Figure 26:** Rotational invariant uniform  $R = 1$ ,  $p = 8$

For Rotational Invariant we have:

$$\text{LBP}_{P,R} = \sum_{i=0}^{P-1} s(p_i - p_c) \times 2^i,$$

Figure 27 shows the percentage of palmprint recognition with ri (24) LBP algorithm. As you see the maximum percentage is (100) and gets when we select (1) and (3) image for testing. The minimum percentage is get when we select (6) and (9) image this percentage is (60).



**Figure 27:** Rotational invariant R = 3, p = 24

Figure 28 shows the percentage of palmprint recognition with ri (16) LBP algorithm. As you see the maximum percentage is (100) and gets when we select (1), (3) and (4) image for testing. The minimum percentage is get when we select (6) and (7) image this percentage is (65).



**Figure 28:** Rotational invariant  $R = 2, p = 16$

Figure 29 show the percentage of palmprint recognition with ri (8) LBP algorithm. As you see the maximum percentage is (100) and get when we select (1) image for testing. The minimum percentage is get when we select (11) image this percentage is (50).



**Figure 29:** Rotational invariant  $R = 1, p = 8$

For Rotational Invariant we have:

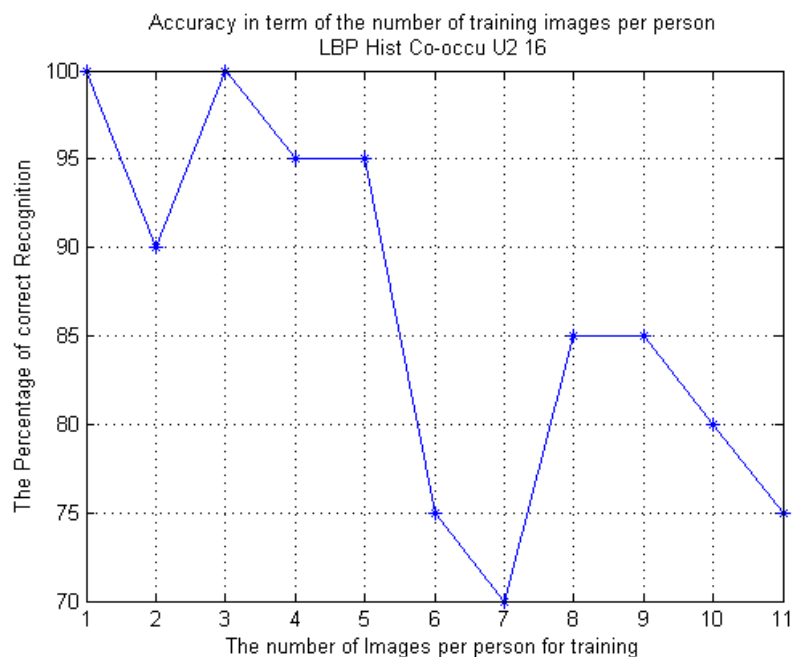
$$LBP_{P,R}^{U_2}(x, y) = \begin{cases} I(LBP_{P,R}(x, y)) & \text{if } U(LBP_{P,R}) \leq 2, I(z) \in [0, (P-1)P+2) \\ (P-1)P+2 & \text{otherwise} \end{cases}$$

Figure 30 show the percentage of palmprint recognition with u2 (24) LBP algorithm. As you see the maximum percentage is (100) and get when we select (1) and (3) image for testing. The minimum percentage is get when we select (7) image this percentage is (65).



**Figure 30:** Uniform R = 3, p = 24

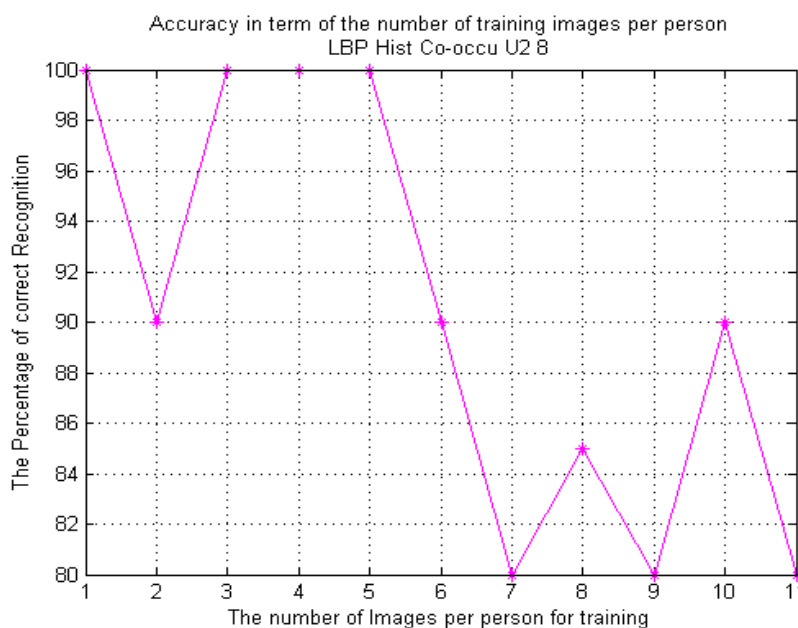
Figure 31 show the percentage of palmprint recognition with u2 (16) LBP algorithm. As you see the maximum percentage is (100) and get when we select (1) and (3) image for testing. The minimum percentage is get when we select (7) image this percentage is (70).



**Figure 31:** Uniform  $R = 2$ ,  $p = 16$

Figure 32 show the percentage of palmprint recognition with u2 (8) LBP algorithm. As you see the maximum percentage is (100) and get when we select (1), (3), (4) and (5) image for testing. The minimum percentage is get when we select (7), (9) and (11) image this percentage is (80).

This algorithm is best algorithm between the entire algorithms. We get high percentage in this algorithm.



**Figure 32:** Uniform  $R = 1$ ,  $p = 8$



## CHAPTER 5

### CONCLUSION

More recognizing machines from the brightness intensity of the pixels are used as input data. Brightness intensity dates' from the Palmprint were under the influence of rotation and changing of environment brightness. In our proposed method, the local binary pattern is used which was strong in state, light changes. Additionally, most of the Palmprint recognition systems which based on binary pattern uses for identifying just from a steady LBP form and only with a certain scale. Obtained characteristics by using LBP single-scale methods gain structure of the image at a particular resolution is not useful for diagnosis of overall image texture and by this method with many discriminate models to obtain useful properties are excluded.

Multi-scale approach can provide more features under different settings. So to achieve more discriminate features with less waste, we used from combination of uniform local binary pattern with a different radius. The proposed method is proposed to identify Palmprints in this paper which is based on combination of co-occurrence matrix according to local binary pattern. The results show that the proposed method has also been stated that the accuracy of all methods is higher and its speed is like the similar algorithm.

In this thesis, we use Palmprint image database of polytechnic university for recognition. After reading image and preprocessing, we take the LBP algorithm for feature extraction. Then for the test of our work, we take the LBP for whole of the images. We use the minimum distance between the images for which image is near the database images. At the end of work we count the true recognized images that this value is the percent of recognized Palmprint image. In addition, we use the PCA algorithm for feature extraction and we compare our method with PCA method.

## REFERENCES

1. **John D., Woodward J., Nicholas M. and Peter T. H., (2005)**, “*Biometrics: Identity Assurance in the Information Age*”, McGraw-Hill, pp. 1-416.
2. **Ruud M. B., Jonathan H., Connell., Sharath P., Nalini K. Ratha, Andrew W., and Senior., (2004)**, “*Guide to Biometrics*”, Springer, pp. 1-26.
3. **Samir N., Michael T., and Raj N., (2002)**, “*Biometrics: Identity Verification in a Networked World*”, Wiley, First Edition, pp. 1-320.
4. **Fu K. S., (1970)**, “*Sequential Methods in Pattern Recognition and Machine Learning*”, Academic Press, pp. 1-13.
5. **Zhou J., Sun D., Qiu Z., Xiong K., Liu D., and Zhang Y., (2009)**, “*Palmprint Recognition by Fusion of Multi-Color Components Cyber-Enabled Distributed Computing and Knowledge Discovery*” The Int’l Civil Aviation Organization Journal, pp. 273–278.
6. **Nabiyev V. V., (2010)**, “*Yapay Zeka İnsan Bilgisayar Etkilesimi, Seçkin Yayıncılık*”, Ankara, Türkiye, pp. 477-480.
7. **Senior A. W., and Robinson A. J., (1998)**, “*An Off-line Cursive Handwriting Recognition System*”, Proceedings of IEEE, Pattern Recognition and Machine Intelligence, PAMI, pp. 309-322.
8. **Castleman K. R., (1996)**, “*Digital Image Processing*”, Prentice Hall, New Jersey, pp. 315-321.

9. **Yang J., Lee N., and Menq C. H., (1995),** “*Application of Computer Vision in Reverse Engineering for 3D Coordinate Acquisition*” American Society of Mechanical Engineers, Manufacturing Engineering Division, MED, Concurrent Product and Process Engineering, pp. 143-156.
10. **Gonzalez R. C., and Woods, R. E., (2002),** “*Digital Image Processing*”, Prentice Hall, pp. 112-115.
11. **Yan J., and Lazaro A., (2003),** “*Reverse Engineering of Sheet Metal Parts Using Machine Vision*”, Proceedings of the ASME Design Engineering Technical Conference, pp. 1085-1095.
12. **Ergen B. and Çalışkan A., (2011),** “*Biyometrik Sistemler ve El Tabanlı Biyometrik Tanıma Karakteristikleri*”, 6th International Advanced Technologies Symposium (IATS’11), Fırat Üniversitesi, Elazığ, Turkey, pp. 121-124.
13. **Türkoglu, I. (1996),** “*Yapay Sinir Ağları ile Nesne Tanıma*”, Fırat Üniversitesi Fen Bilimleri Enstitüsü, pp. 9-30.
14. **Young I. T., Gerbrands J. J., and Villet L. J. V., (1998),** “*Fundamentals of Image Processing*”, pp. 49-56.
15. **Dede G. and Sazlı, M. H., (2009),** “*Biyometrik Sistemlerin Örüntü Tanıma Perspektifinden İncelenmesi ve Ses Tanıma Modülü Simülasyonu*”, EEBBM Ulusal Kongresi (Elektrik–Elektronik-Bilgisayar ve Biyomedikal Mühendisliği 13. Ulusal Kongresi ve Fuarı), ‘Teknolojide Bulusuyoruz’, ODTÜ, Ankara, pp. 1-5.
16. **Image Processing Toolbox for use with MATLAB, (1998),** User’s Guide, The Mathworks Inc., pp. 7-18.

17. **Ahonen T., Hadid, A., and Pietikainen, M. (2004)**, “*Face Recognition with Local Binary Patterns*”. Proceedings of European Conference Computer Vision. pp. 469-481.
18. **Li S. Z., Chu, R., Liao, S. and Zhang, L. (2007)**, “*Illumination Invariant Face Recognition Using Near-Infrared Images*” IEEE Transactions on Pattern Analysis and Machine Intelligence, Vol. 29, pp. 627-639.
19. **Gonzales R. C. and Woods, R. E. (2001)**, “*Digital Image Processing*”, 259nd Edit ion, ABD, pp. 1-750.
20. **Özdemir A., (2007)**, “*Dalgacik Dönüşümünü Kullanarak ön Cepheden Çekilmiş İnsan Yüzü Resimlerinin Tanınması*”, Yüksek Lisans Tezi, Kahramanmaraş Sütcü Imam Üniversitesi Fen Bilimleri Enstitüsü, Kahramanmaraş, Türkiye, pp. 1-27.
21. **Murase H. and Nayar S. K., (1995)**, “*Visual Learning and Recognition of 3-D Objects From appearance*”, International Journal of Computer Vision, pp. 5–24.
22. **Ahmed N., Natarajan T. and Rao K. R., (1974)**, “*On Image Processing and a Discrete Cosine Transform*”, IEEE Transactions on Computers, pp. 90–93.
23. **Crane R., (1997)**, “*A Simplified Approach to Image Processing*”, Prentice Hall, New Jersey, pp. 123-132.
24. **Manjunath B. S. and Ma W.Y., (1996)**, “*Texture Features for Browsing and Retrieval of Image Data*”, IEEE Transaction on Pattern Analysis and Machine Intelligence, pp. 837-842.
25. **Abe S., (2001)**, “*Neuro-Fuzzy Methods and Their Comparison*”, Springer-Verlag, London, pp. 120-131.

26. **Tao J., Jiang W., Gao, Z., Chen, S. and Wang, C., (2006)**, “*Palmprint Recognition Based on Dimensional PCA*”, First International Conference on Innovative Computing, Information and Control, Beijing, pp. 326-330.
27. **Lu J., Zhang, E., Kang X., Xue Y. and Chen Y., (2006)**, “*Palmprint Recognition Using Wavelet Decomposition and 2D Principal Component Analysis*”, International Conference on Communication, Circuits, and Systems, Guilin, pp. 2133-2136.
28. **Lu G., Wang K. and Zhang D., (2004)**, “*Wavelet Based Independent Component Analysis for Palmprint Identification*”, 3rd. International Conference on Machine Learning and Cybernetics, Shanghai, pp. 3547-3550.
29. **Zhang L. and Zhang D., (2004)**, “*Characterization of Palmprints by Wavelet Signatures via Directional Context Modeling*”, IEEE Transactions on Systems, Man, and Cybernetics, pp. 1335-1347.
30. **Wu X., Zhang D. and Wang K., (2003)**, “*Fisherpalms Based Palmprint Recognition, Pattern Recognition Letters*”, International Journal of Computer Vision, pp. 2829–2838.
31. **Lu G., Zhang D., and Wang K., (2003)**, “*Palmprint Recognition Using Eigenpalms Features, Pattern Recognition Letters*”, International Journal of Computer Vision, pp. 1463–1467.
32. **Wang Y., and Ruan Q., (2006)**, “*Kernel Fisher Discriminant Analysis for Palmprint Recognition*”, The 18th International Conference on Pattern Recognition, Hong Kong, pp. 57–60.
33. **Jing X. Y., and Zhang D., (2004)**, “*A Face and Palmprint Recognition Approach Based on Discriminant DCT Feature Extraction*”, IEEE Transactions on Systems, Man, and Cybernetics, pp. 2405–2415.

- 34. Jiang W., Tao J. and Wang L., (2006),** “*A Novel Palmprint Recognition Algorithm Based on PCA and FLD*”, Int. Conference. on Digital Telecommunications. Cote d'Azur, pp. 28-28.
- 35. Kumar A. and Zhang D., (2006),** “*Personal Recognition Using Hand Shape and Texture*”, IEEE Transactions on Image Processing, pp. 2454–2460.
- 36. Zhang D., Kongi W., You J. and Wong M., (2003),** “*Online Palmprint Identification*”, IEEE Transactions on Pattern Analysis and Machine Intelligence, pp. 1041–1049.
- 37. Kong A., Zhang D., and Kamel M. (2009),** “*A Survey of Palmprint recognition*” Journal of Pattern Recognition, Vol. 42, pp. 1408–1418.
- 38. Goh K. O. M., Tee C. and Andrew B. J. T., (2004),** “*A Contactless Biometric System Using Palm Print and Palm Vein Features*” Advanced Biometric Technologies, pp. 155-180.
- 39. Hietmeyer R., (2000),** “*Biometric Identification Promises Fast and Secure Processing of Airline Passengers*”, The Int’l Civil Aviation Organization Journal, Vol. 55, No. 9, pp. 10–11.
- 40. Chin C. H., Hsu L. C., Chih L. L. and Kuo C. F., (2003),** “*Personal Authentication Using Palmprint Features*”, Pattern Recognition, Volume 36, Issue 2, February, pp. 371-381.
- 41. Shahla S., Nasrollah M. C., (2014),** “*Palmprint Authentication Based on Discrete Orthonormal S-Transform*”, Original Research Article Applied Soft Computing, Vol. 21, pp. 341-351.

- 42. Feng Y., and Wangmeng Z., (2014),** “*Consistency Analysis on Orientation Features for Fast and Accurate Palmprint Identification*”, Original Research Article Information Sciences, Vol. 268, pp. 78-90.
- 43. Antonio I., Alessandro S. S., and Giosue C., (2014),** “*An Ultrasound Technique for 3D Palmprint Extraction*”, Original Research Article, Sensors and Actuators A: Physical, Vol. 212, pp. 18-24.
- 44. Xiumei G., Weidong Z., and Yu W., (2014),** “*Palmprint Recognition Algorithm with Horizontally Expanded Blanket Dimension*”, Original Research Article, Neurocomputing, Vol. 127, pp. 152-160.
- 45. Ojala T., and Pietikainen H. M., (1996),** “*A Comparative Study of Texture Measures with Classification Based on Feature Distributions*”, Pattern Recognition, Vol. 29, No. 1, pp. 51–59.
- 46. Maenpaa T., Ojala T., Pietikainen M., and Maricor S., (2000),** “*Robust Texture Classification by Subsets of Local Binary Patterns in Pattern Recognition*”, International Conference on, Vol. 3, pp. 39-47.
- 47. Haralick R. M., Shanmugam K., and Dinstein I., (1973),** “*Textural Features for Image Classification,*” Transactions on Systems, Man and Cybernetics, Vol. 3, No. 6, pp. 610-621.
- 48. Nissim K., and Harel E., (1997),** “*A Texture Based Approach to Defect Analysis of Arapefruits*”, Proceeding IPDPS '05 Proceedings of the 19th IEEE International Parallel and Distributed Processing Symposium (IPDPS'05), Vol. 1, pp. 42-49.
- 49. Alam F. I., and Faruqui R. U., (2011),** “*Optimized Calculations of Haralick Texture Features*”, European Journal of Scientific Research, Vol. 50 No. 4, pp. 543-553.

50. <http://www4.comp.polyu.edu.hk>, (Data Download Date: 15.09.2014).

51. **Benson G., (2002)**, “*A New Distance Measure for Comparing Sequence Profiles Based on Paths Along an Entropy Surface*” In Proceedings of the European Conference on Computational Biology, pp. 44-53.



## APPENDICES A

### CURRICULUM VITAE

#### PERSONAL INFORMATION

**Surname, Name:** FARGO, Janan

**Date and Place of Birth:** 22 March 1980, Baghdad, Iraq

**Marital Status:** Single

**Phone:** Turkey 00905380406823 - Iraq 009647903339596

**Email:** iamjanancs@yahoo.com



#### EDUCATION

Degree	Institution	Year of Graduation
M.Sc.	Çankaya University	2015
B.Sc.	University of Technology	2003
High School	Al Morog High School	1999

#### FOREIGN LANGUAGES

English.

#### HOBBIES

Travel, Reading Books, Swimming, Fitness and Playing Video Games.