



**SPEED CONTROL OF BLDC MOTOR BASED ON MULTICRITERIA
OPTIMIZATION
WITH GENETIC ALGORITHM**

NURULLAH SEZİK

FEBRUARY 2020

**SPEED CONTROL OF BLDC MOTOR BASED ON MULTICRITERIA
OPTIMIZATION**

WITH GENETIC ALGORITHM

A THESIS SUBMITTED TO

THE GRADUATE SCHOOL OF NATURAL AND APPLIED

SCIENCES OF

ÇANKAYA UNIVERSITY

BY

NURULLAH SEZİK

IN PARTIAL FULFILLMENT OF THE REQUIREMENTS FOR THE

DEGREE OF

MASTER OF SCIENCE

IN

THE DEPARTMENT OF

MECHATRONICS ENGINEERING

FEBRUARY 2020

Title of the Thesis: **Speed Control of BLDC Motor Based on Multicriteria Optimization with Genetic Algorithm**

Submitted by **Nurullah SEZİK**

Approval of the Graduate School of Natural and Applied Sciences, Çankaya University.



Prof. Dr. Can ÇOĞUN

Director

I certify that this thesis satisfies all the requirements as a thesis for the degree of Master of Science.



Assist. Prof. Dr. Ulaş BELDEK

Head of Department

This is to certify that we have read this thesis and that in our opinion it is fully adequate, in scope and quality, as a thesis for the degree of Master of Science.

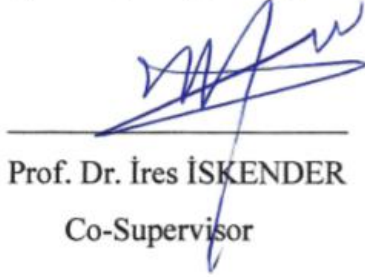

Prof. Dr. İres İSKENDER
Co-Supervisor

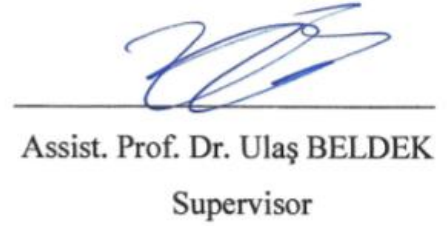

Assist. Prof. Dr. Ulaş BELDEK
Supervisor

Examination Date: 07.02.2020

Examining Committee Members

Prof. Dr. Klaus Werner SCHMIDT (METU)

Assist. Prof. Dr. Ulaş BELDEK (Çankaya Univ.)

Assist. Prof. Dr. Halit ERGEZER (Çankaya Univ.)



STATEMENT OF NON-PLAGIARISM PAGE

I hereby declare that all information in this document has been obtained and presented in accordance with academic rules and ethical conduct. I also declare that, as required by these rules and conduct, I have fully cited and referenced all material and results that are not original to this work.

Name, Last Name : Nurullah SEZİK
Signature : 
Date : 07.02.2020

ABSTRACT

SPEED CONTROL OF BLDC MOTOR BASED ON MULTICRITERIA OPTIMIZATION WITH GENETIC ALGORITHM

NURULLAH SEZİK

M.Sc., Department of
Mechatronics Engineering

Supervisor: Assist. Prof. Dr. Ulaş BELDEK

Co-Supervisor: Prof. Dr. İres İSKENDER

February 2020, 73 pages

In this thesis, a brushless DC (BLDC) motor's speed control is handled by developing two different control structures using Genetic Algorithm. The speed control application is governed as a multi-criteria optimization problem where each criterion is taken as the time domain performance criteria of the controlled closed loop system. Within this scope, the main objective is to capture the reference speed signal as quickly as possible by the help of rise time and settling time criteria, minimizing the steady-state error value, keeping overshoot as minimum as possible and observing no undershoot. For this purpose, Genetic Algorithm (GA) method is utilized to adjust either a proportional-integral (PI) controller parameters or to select the most suitable inputs and the outputs parameters for normalization factors of Fuzzy Logic Controller (FLC). All optimization process is carried out using a BLDC Motor Model.

Keywords: BLDC Motor, Linearization, Multicriteria Optimization, Genetic Algorithm, PI Controller, Fuzzy Logic Controller, Transfer Function, Root Locus.

ÖZ

GENETİK ALGORİTMA İLE ÇOK AMAÇLI OPTİMİZASYON TABANLI BLDC MOTOR HIZI KONTROLÜ

NURULLAH SEZİK

Yüksek Lisans

Mekatronik Mühendisliği

Anabilim Dalı

Tez Yöneticisi: Dr. Öğr. Üye. Ulaş BELDEK

Ortak Tez Yöneticisi: Prof. Dr. İres İSKENDER

Şubat 2020, 73 pages

Bu tezde, Fırçasız DC (BLDC) motorun hızı, iki farklı kontrol yapısı geliştirilerek, Genetik Algoritma kullanılarak kontrol edilmiştir. Hız kontrol uygulaması, her kriterin kontrollü kapalı döngü sisteminin zaman alanı performans kriterleri olarak alındığı çok kriterli bir optimizasyon problemi olarak yönetilir. Bu kapsamda temel hedefler referans hız sinyalinin yükselme zamanı ve çökme süresi kriterleri yardımıyla mümkün olduğunca çabuk yakalamak, kararlı durum hata değerini en aza indirmek, mümkün olan en az aşımı sürdürmek ve bir aşınma gözlemlememek olarak belirlenmiştir. Bu amaçla Genetik Algoritma (GA) yöntemi, orantılı-integral (PI) denetleyici parametrelerini ayarlamak ve Bulanık Mantık Denetleyicisinin (FLC) normalleştirme faktörleri için en uygun giriş ve çıkış parametrelerini seçmek için kullanılır. Tüm bu optimizasyon işlemleri BLDC Motor Modeli kullanılarak gerçekleştirilmiştir.

Anahtar Kelimeler: Fırçasız DC Motor, Doğrusallaştırma, Çok Kriterli Optimizasyon, Genetik Algoritma, Oransal-İntegral Kontrol, Bulanık Mantık Kontrolör, Transfer Fonksiyonu, Kök Yerleşimi.

ACKNOWLEDGEMENTS

I would like to express my sincere gratitude to Assist. Prof. Dr. Ulaş BELDEK for his supervision, special guidance, suggestions, and encouragement through the development of this thesis.

I would like to express special thanks to my Co-Supervisor Prof.Dr. İres İSKENDER at the same time.



TABLE OF CONTENTS

STATEMENT OF NON-PLAGIARISM.....	iii
ABSTRACT.....	iv
ÖZ.....	v
ACKNOWLEDGEMENTS.....	vi
TABLE OF CONTENTS.....	vii
LIST OF FIGURES.....	xii
LIST OF TABLES.....	xvi
LIST OF ABBREVIATIONS.....	xvii

CHAPTERS:

1. INTRODUCTION.....	1
1.1. BLDC Motors.....	1
1.2. Thesis Organization.....	4
2. BLDC MOTOR MATHEMATICAL MODEL.....	5
3. CONTROLLER STRUCTURES.....	8
3.1. Controllers.....	9
3.2. Step Responses.....	11
4. GENETIC ALGORITHM.....	12
4.1. Explanation of Genetic Algorithm.....	12

4.1.1. Gen.....	12
4.1.2. Chromosome.....	13
4.1.3. Population.....	13
4.2. Application of Genetic Algorithm.....	13
4.3. PI Test Result (With GA Single) Table.....	19
4.4. PI Test Result (With GA Multiple) Table.....	20
4.5. FLC Test Result (With GA Multiple) Table.....	20
4.6. Optimization&Validation Table for All Controllers.....	20
5. THE PERFORMANCE INDICES OF CONTROLLERS.....	21
5.1. CASE 1 PERFORMANCE INDICES OF CONTROLLERS.....	21
5.1.1. FLC [14] 0-20.....	21
5.1.2. PI (R.L) [14] 0-20.....	22
5.1.3. PI (GA) (Single) 0-20.....	22
5.1.4. PI (GA) (Multiple) 0-20.....	23
5.1.5. FLC (GA) (Multiple) 0-20.....	23
5.1.6. FLC [14] 20-40.....	24
5.1.7. PI (R.L) [14] 20-40.....	24
5.1.8. PI (GA) (Single) 20-40.....	25
5.1.9. PI (GA) (Multiple) 20-40.....	25
5.1.10. FLC (GA) (Multiple) 20-40.....	26
5.1.11. FLC [14] 0-100.....	26
5.1.12. PI (R.L) [14] 0-100.....	27
5.1.13. PI (GA) (Single) 0-100.....	27

5.1.14. PI (GA) (Multiple) 0-100.....	28
5.1.15. FLC (GA) (Multiple) 0-100.....	28
5.1.16. FLC [14] 0-400.....	29
5.1.17. PI (R.L) [14] 0-400.....	29
5.1.18. PI (GA) (Single) 0-400	30
5.1.19. PI (GA) (Multiple) 0-400.....	30
5.1.20. FLC (GA) (Multiple) 0-400.....	31
5.1.21. FLC [14] 200-400.....	31
5.1.22. PI (R.L) [14] 200-400.....	32
5.1.23. PI (GA) (Single) 200-400.....	32
5.1.24. PI (GA) (Multiple) 200-400.....	33
5.1.25. FLC (GA) 200-400 (Multiple).....	33
5.1.26. FLC [14] 380-400.....	34
5.1.27. PI (R.L) [14] 380-400.....	34
5.1.28. PI (GA) (Single) 380-400.....	35
5.1.29. PI (GA) (Multiple) 380-400.....	35
5.1.30. FLC (GA) (Multiple) 380-400.....	36
5.1.31. FLC [14] 300-350.....	36
5.1.32. PI (R.L) [14] 300-350.....	37
5.1.33. PI (GA) (Single) 300-350.....	37
5.1.34. PI (GA) (Multiple) 300-350.....	38
5.1.35. FLC (GA) (Multiple) 300-350.....	38
5.1.36. OPTIMIZATION PHASE (CASE 1) RESULTS.....	41
5.2. CASE 2 PERFORMANCE INDICES OF CONTROLLERS.....	42

5.2.1. FLC [14] (40)-(20).....	42
5.2.2. PI (R.L) [14] (40)-(20).....	43
5.2.3. PI (GA) (Single) (40)-(20).....	43
5.2.4. PI (GA) (Multiple) (40)-(20).....	44
5.2.5. FLC (GA) (Multiple) (40)-(20).....	44
5.2.6. FLC [14] (-20)-(-40).....	45
5.2.7. PI (R.L) [14] (-20)-(-40).....	45
5.2.8. PI (GA) (Single) (-20)-(-40).....	46
5.2.9. PI (GA) (Multiple) (-20)-(-40).....	46
5.2.10. FLC (GA) (Multiple) (-20)-(-40).....	47
5.2.11. FLC [14] (0)-(-400).....	47
5.2.12. PI (R.L) [14] (0)-(-400).....	48
5.2.13. PI (GA) (Single) (0)-(-400).....	48
5.2.14. PI (GA) (Multiple) (0)-(-400).....	49
5.2.15. FLC (GA) (Multiple) (0)-(-400).....	49
5.2.16. FLC [14] (400)-(380).....	50
5.2.17. PI (R.L) [14] (400)-(380).....	50
5.2.18. PI (GA) (Single) (400)-(380).....	51
5.2.19. PI (GA) (Multiple) (400)-(380).....	51
5.2.20. FLC (GA) (Multiple) (400)-(380).....	52
5.2.21. FLC [14] (-380)-(-400).....	52
5.2.22. PI (R.L) [14] (-380)-(-400).....	53
5.2.23. PI (GA) (Single) (-380)-(-400).....	53
5.2.24. PI (GA) (Multiple) (-380)-(-400).....	54

5.2.25. FLC (GA) (Multiple) (-380)-(-400).....	54
5.2.26. VALIDATION PHASE (CASE 2) RESULTS.....	56
6. EFFECT OF NORMALIZATION OF COST FUNCTION.....	58
6.1. FLC NORMALIZATION 1 FOR OPTIMIZATION PHASE (CASE 1).....	60
6.1.1. FLC (GA)(Multiple) 0-20.....	60
6.1.2. FLC (GA)(Multiple) 20-40.....	60
6.1.3. FLC (GA)(Multiple) 0-100.....	61
6.1.4. FLC (GA)(Multiple) 0-400.....	61
6.1.5. FLC (GA)(Multiple) 200-400.....	62
6.1.6. FLC (GA)(Multiple) 380-400.....	62
6.1.7. FLC (GA)(Multiple) 300-350.....	63
6.2. FLC NORMALIZATION 2 FOR OPTIMIZATION PHASE (CASE 1).....	63
6.2.1. FLC (GA)(Multiple) 0-20.....	63
6.2.2. FLC (GA)(Multiple) 20-40.....	64
6.2.3. FLC (GA)(Multiple) 0-100.....	64
6.2.4. FLC (GA)(Multiple) 0-400.....	65
6.2.5. FLC (GA)(Multiple) 200-400.....	65
6.2.6. FLC (GA)(Multiple) 380-400.....	66
6.2.7. FLC (GA)(Multiple) 300-350.....	66
7. CONCLUSION	70
REFERENCES.....	71
APPENDICES.....	73
A. CURRICULUM VITAE.....	73

LIST OF FIGURES

FIGURES

- Figure 1** Open Loop BLDC Motor Model
- Figure 2** Sub-system model of open loop BLDC motor
- Figure 3** The structure of the PI Controller
- Figure 4** The structure of the FLC
- Figure 5** The Inner Structure of the FLC
- Figure 6** Closed loop PI control for the angular speed of the BLDC Motor
- Figure 7** Closed loop FLC control for the angular speed of the BLDC Motor
- Figure 8** Step Responses
- Figure 9** The structure of a chromosome representing PI controller
- Figure 10** The structure of a chromosome Representing FLC controller
- Figure 11** FLC [14] 0-20
- Figure 12** PI (R.L) [14] 0-20
- Figure 13** PI (GA) (Single) 0-20
- Figure 14** PI (GA) (Multiple) 0-20
- Figure 15** FLC (GA) (Multiple) 0-20
- Figure 16** FLC [14] 20-40
- Figure 17** PI (R.L) [14] 20-40
- Figure 18** PI (GA) (Single) 20-40
- Figure 19** PI (GA) (Multiple) 20-40
- Figure 20** FLC (GA) (Multiple) 20-40
- Figure 21** FLC [14] 0-100

- Figure 22** PI (R.L) [14] 0-100
- Figure 23** PI (GA) (Single) 0-100
- Figure 24** PI (GA) (Multiple) 0-100
- Figure 25** FLC (GA) (Multiple) 0-100
- Figure 26** FLC [14] 0-400
- Figure 27** PI (R.L) [14] 0-400
- Figure 28** PI (GA) (Single) 0-400
- Figure 29** PI (GA) (Multiple) 0-400
- Figure 30** FLC (GA) (Multiple) 0-400
- Figure 31** FLC [14] 200-400
- Figure 32** PI (R.L) [14] 200-400
- Figure 33** PI (GA) (Single) 200-400
- Figure 34** PI (GA) (Multiple) 200-400
- Figure 35** FLC (GA) (Multiple) 200-400
- Figure 36** FLC [14] 380-400
- Figure 37** PI (R.L) [14] 380-400
- Figure 38** PI (GA) (Single) 380-400
- Figure 39** PI (GA) (Multiple) 380-400
- Figure 40** FLC (GA) (Multiple) 380-400
- Figure 41** FLC [14] 300-350
- Figure 42** PI (R.L) [14] 300-350
- Figure 43** PI (GA) (Single) 300-350
- Figure 44** PI (GA) (Multiple) 300-350
- Figure 45** FLC (GA) (Multiple) 300-350
- Figure 46** FLC [14] (40)-(20)

- Figure 47** PI (R.L) [14] (40)-(20)
- Figure 48** P I (GA) (Single) (40)-(20)
- Figure 49** PI (GA) (Multiple) (40)-(20)
- Figure 50** FLC (GA) (Multiple) (40)-(20)
- Figure 51** FLC [14] (-20)-(-40)
- Figure 52** PI (R.L) [14] (-20)-(-40)
- Figure 53** PI (GA) (Single) (-20)-(-40)
- Figure 54** PI (GA) (Multiple) (-20)-(-40)
- Figure 55** FLC (GA) (Multiple) (-20)-(-40)
- Figure 56** FLC [14] (0)-(-400)
- Figure 57** PI (R.L) [14] (0)-(-400)
- Figure 58** PI (GA) (Single) (0)-(-400)
- Figure 59** PI (GA) (Multiple) (0)-(-400)
- Figure 60** FLC (GA) (Multiple) (0)-(-400)
- Figure 61** FLC [14] (400)-(380)
- Figure 62** PI (R.L) [14] (400)-(380)
- Figure 63** PI (GA) (Single) (400)-(380)
- Figure 64** PI (GA) (Multiple) (400)-(380)
- Figure 65** FLC (GA) (Multiple) (400)-(380)
- Figure 66** FLC [14] (-380)-(-400)
- Figure 67** PI (R.L) [14] (-380)-(-400)
- Figure 68** PI (GA) (Single) (-380)-(-400)
- Figure 69** PI (GA) (Multiple) (-380)-(-400)
- Figure 70** FLC (GA) (Multiple) (-380)-(-400)
- Figure 71** FLC (GA) (Multiple) Norm 1 (0)-(20)

- Figure 72** FLC (GA) (Multiple) Norm 1 (20)-(40)
- Figure 73** FLC (GA) (Multiple) Norm 1 (0)-(100)
- Figure 74** FLC (GA) (Multiple) Norm 1 (0)-(400)
- Figure 75** FLC (GA) (Multiple) Norm 1 (200)-(400)
- Figure 76** FLC (GA) (Multiple) Norm 1 (380)-(400)
- Figure 77** FLC (GA) (Multiple) Norm 1 (300)-(350)
- Figure 78** FLC (GA) (Multiple) Norm 2 (0)-(20)
- Figure 79** FLC (GA) (Multiple) Norm 2 (20)-(40)
- Figure 80** FLC (GA) (Multiple) Norm 2 (0)-(100)
- Figure 81** FLC (GA) (Multiple) Norm 2 (0)-(400)
- Figure 82** FLC (GA) (Multiple) Norm 2 (200)-(400)
- Figure 83** FLC (GA) (Multiple) Norm 2 (380)-(400)
- Figure 84** FLC (GA) (Multiple) Norm 2 (300)-(350)

LIST OF TABLES

TABLES

- Table 1** BLDC motor values in BLDC motor model
- Table 2** Rule base structure of the FLC controller
- Table 3** Speed Ranges Case 1
- Table 4** Speed Ranges Case 2
- Table 5** Best Chromosomes for PI (GA Multiple) Controller
- Table 6** Best Chromosomes for PI (GA Multiple) Controller
- Table 7** Best Chromosomes for FLC (GA Multiple) Controller
- Table 8** Optimization Phase (Case 1) Motor Ranges Results
- Table 9** Validation Phase (Case 2) Motor Ranges Results
- Table 10** Best Chromosomes for FLC (GA Multiple) Norm 1&2
Controller
- Table 11** FLC (GA Multiple) Normalization 1&2 For Case 1

LIST OF ABBREVIATIONS

PMBLDC	Permanent Magnet Brushless DC
PI	Proportional Integral
FLC	FLC Logic Controller
PWM	Pulse Width Modulation
Back- EMF	Back Electromagnetic Force
RPM	Revolutions Per Minute
BLDC	Brushless DC
P	Proportional
PID	Proportional Integral Derivative
PMS	Permanent Magnet Synchronous
E_a, E_b, E_c	Back-EMF for each phase
I_a, I_b, I_c	Stator currents for each phase
V_{ab}, V_{bc}, V_{ca}	Line to line voltage
V_{dc}	Supply voltage
I_{dc}	Supply current
R_a, R_b, R_c	The stator resistance for each phase
L_a, L_b, L_c	Inductance for each phase
PMAC	Permanent Magnet Alternating Current
w_m	The Mechanical speed
K_e	Motor voltage constants
T_e	Total electromagnetic torque
T_L	Load torque
p	Number of poles

I_{\max}	Max current
K_T	Torque constant of the motor
T_{\max}	Maximum current
t_r	Rise time
t_s	Settling time
w_r	Electrical speed
W_{m_ss}	Steady-State Mechanical Speed
Final W_{m_ss}	Final Steady-State Mechanical Speed



CHAPTER 1

INTRODUCTION

1.1 BLDC Motors

Brushless DC Motors (BLDC) have been widely used as they are suitable for different kinds of applications [1-7]. Their area of application ranges from industry to aerospace. BLCD motors can be applied for constant load, variable load and positioning applications in respective of their size and dimensions. Recently, one of the main issues that the researchers mainly focus on about BLDC motors is their control structure [5], [8], [9]. Various conventional control strategies like P, PI control can be applied to these motor [5], [14] as well as intelligent techniques such as FLC Logic [10], [12], [14] Neural Networks [11].

Deeper information about BLDC motors can be obtained from [12], [14]. Besides the mathematical model for some types of these motor also exist in [12], [13], [14].

Two different control modes should be used in harmony to control the BLDC motor. The first control mode is used for adjustment and reshaping of the stator currents of the BLDC motor in terms of magnitude and structure and that process is accomplished generally by the help of hysteresis or PWM current control techniques [6], [7], [12], [14]. The second control mode is used for the main control purpose where the motor is intentionally driven for various control applications. Among these control applications one of them is (angular) speed control. In [14] linearization of the model of a BLDC motor having a hysteresis stator current control mode is performed and approximate linearized system model is obtained. Due to the linearized model of the BLDC motor possessing hysteresis current control mode, P and PI controllers are designed for the second control mode which is actually the speed control application. The design of the P and PI controllers are performed by

the help of Root Locus technique. After P and PI controllers are designed, their performance is compared with FLC structure that is working properly for the same speed control applications. This procedure to obtain P and PI controllers in [14] has two drawbacks. Firstly in [14] the PI and P controllers were obtained due to linearized model of the BLDC motor in a specific speed range. However at various speed ranges different linearization of the model might be more accurate compared to specific speed range chosen for linearization in [14]. For this reason, it is better to implement different PI or P controllers in different speed ranges or new technique should be considered that adjust to parameters of the P or PI controllers accounting different speed ranges. Secondly the P and PI controllers in [14] are developed only examining frequency domain information: the closed loop pole locations of the approximate linearized model are evaluated by the help of Root Locus technique. In [14], generally time domain performance indices such as steady-state error, rise time, maximum overshoot, settling time and undershoot (if available in the system response) are just controlled after the controller structure is determined and maintained. These performance indices such as rise time, settling time, maximum overshoot and steady-state error are not part of the controller design process instead they are passively obtained after the nonlinear system is driven by the P or PI controller. Hence these performance indices in some simulations tend to demonstrate unsatisfactory results. In [14] the rule-structure of the FLC controller used in [12] is implemented using Gaussian membership functions whereas in [12] trapezoidal membership functions are employed. Besides the nominal values of the FLC controller input and output normalization parameters in [12] are not explicitly given. Hence in [14] these FLC parameters are obtained by some trial and error method. With all of these settings P and PI controllers developed in [14] are compared with the FLC controller developed in [14] and FLC controller generally exhibits better results in terms of the performance indices. However, the FLC can also be made more efficient by parameter tuning. Besides a new method can be proposed to develop the FLC by considering different speed levels into account. For improving the drawbacks of the previous study, the aim of this thesis is determined as generating better control structures by taking different aspects especially the time domain performance indices into account.

For this reason, in this thesis a multi-criteria cost optimization problem is set that to adjust the parameters of a PI controller and the FLC. Each time domain performance index is assigned as a criterion of the cost. After the criteria are evaluated the cost is obtained as a total summation of each criterion with their own weight value. Then GA is applied in order to minimize the cost function. For developing the PI controllers, the cost function is minimized to obtain the most satisfactory PI parameters whereas for developing the FLC the cost function is minimized to adjust the normalization factors of the FLC whose rule structure is the same as the rule-structure of [12], [14]. Besides the optimization process is handled with different intentions. In some optimization applications (for PI controller and FLC design) the controller structure is developed by considering different speed levels into account in the cost function whereas in some other optimization applications (PI controller design) a single speed level is used in the optimization process to adjust the controller parameters. The first approach is called as either Multiple PI approach (in case a PI controller is developed) or Multiple FLC approach (in case a FLC controller is developed) the second approach is called as Single PI approach (in case single PI controller is developed for each speed range separately). In [12] the performance of the controllers (whether it is PID or FLC) is only tested for a single speed range: the controllers are trying to adjust the speed of the BLDC motor from 0 rot/min (0 rad/sec) to 4000 rot/min (418.879 rad/sec). However, in reality in order to demonstrate the performance of the controller the controller should be tested also in different speed ranges. That issue is not considered in [12]. In [14] after the controller structures are developed only some tests are carried out for different speed ranges. One of the missing issues in both [12] and [14] are also the simulation parameters in MATLAB/Simulink. In both of these studies [12], [14] two of the most important simulation parameters are not mentioned: it is the step size of the solver and selected differential equation solver. Throughout the simulations done in this thesis, it is observed that, these parameters are so important for the stability and transient behavior of the closed loop system and the optimization duration. Hence for a fair comparison of PI and FLC controllers they should be selected similarly. After the controllers are developed the efficiency of the control structures can be tested with different step-sizes in test applications. Lastly in important parameter for multi-

criteria optimization applications is weight adjustment. In different optimization runs weight adjustment is also performed to tune the comparative effects of each criterion at the cost function in this thesis.

1.2 Thesis Organization

The thesis consists of seven sections. The first section gives general information about BLDC Motors and thesis subject. The second section describes the mathematical model of the BLDC motor. The third section gives information about type of controllers that are employed. The fourth chapter gives details about the usage of GA for optimizing controller parameters employing a multi-criteria cost function: describes how the Single PI, Multiple PI and Multiple FLC approaches are integrated into the optimization process by application of GA and this chapter also demonstrates the results of the optimization applications and compares them with the previous studies re-simulated results. Chapter five and six gives conclusion graphs and tables of optimization phase (Case1), validation phase (Case 2) and normalization of cost function based on different aspects. Chapter 7 includes the concluding remarks.

CHAPTER 2

BLDC MOTOR MATHEMATICAL MODEL

In this thesis the mathematical model of the BLDC motor put forward in [12], [13] and [14] are implemented employing MATLAB/SIMULINK code produced for [14]. The model produced in [14] has two parts. The first part is the uncontrolled plant model of the BLDC motor where the input to the plant is the torque applied to the BLDC motor and the output is the corresponding angular velocity of the motor. The second part is the controller. What is done in this thesis is integrating the first part of the model produced in [14] inside a GA optimization process that minimizes a multi-criteria GA cost function that weighs the comprehensive importance of time domain performance criteria in closed loop system response by adjusting either the parameters of a PI controller or the normalization factors of a FLC. For this purpose, the BLDC model parameters in [12] that are also applied [14] are preferred. These parameters are given in Table 1.

Table 1: BLDC motor values in BLDC motor model [12], [14].

Number of Phase	3(star)
Rated speed	4228 rpm (442.7551 rad/sec)
Rated current	6.8 A
Number of poles	8
Moment of inertia (J)	0.000019 Nm-
Voltage constant (K_e)	0.0419 V/(rad/s)
Torque constant (K_t)	0.0419 Nm/A
Stator equivalent resistance (R)	0.348
Stator equivalent inductance (L)	0.000314 H

Using the plant mathematical structure explained in [12] and [14], the corresponding BLDC motor model given in Figure 1 is obtained. In this model the system is in uncontrolled (open loop) form. Its input is T_{max} (in Newton.m) which is the applied torque to the motor and output is the angular velocity of the motor which is in rad/sec. In this model in order not to let the current exceed critical values some saturation element is also inserted to the model which limits the current value between 40 Amperes and -40 Amperes.

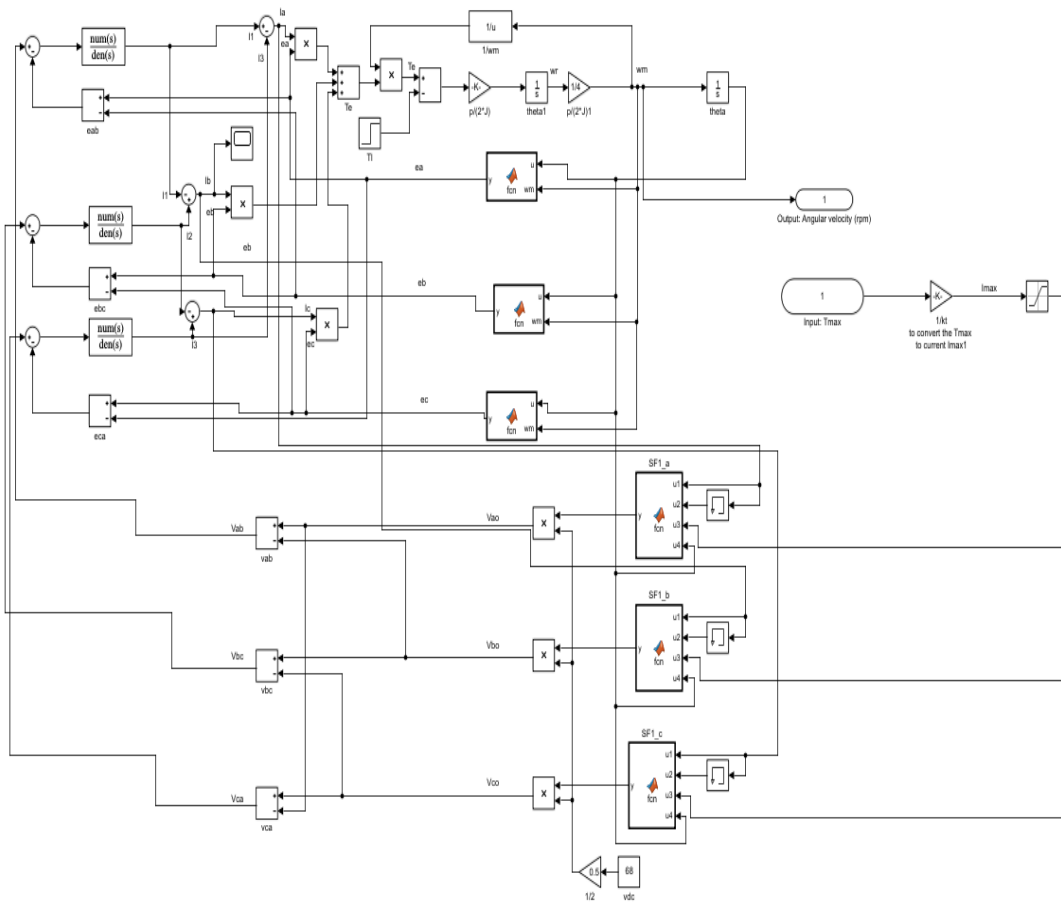

Figure 1: Open Loop BLDC Motor Model

This model is defined as a sub-system block in MATLAB/SIMULINK. The corresponding sub-system block that can be replaced instead of the model in Figure 1 is obtained. The sub-system block is given in Figure 2.

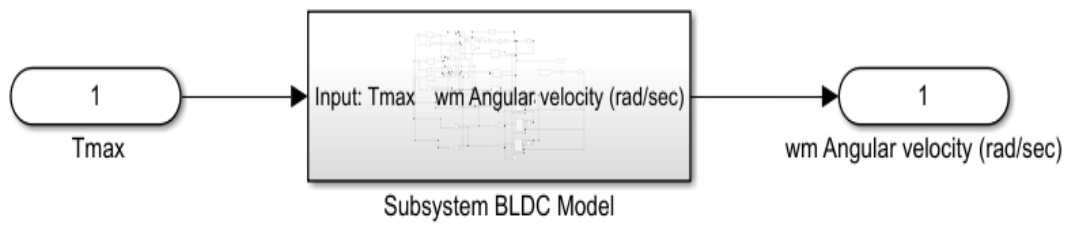

Figure 2: Sub-system model of open loop BLDC motor.



CHAPTER 3

CONTROLLER STRUCTURES

In order to control the open loop system given in Chapter 2 that is described by the block diagram in Figures 1 or 2, two controller structures are proposed. The first controller structure is a PI controller and the second one is a FLC controller. In previous works of [12] and [14] either a fixed control structure whose parameter are determined intuitively is put forward assuming that the controller structure performs the control task sufficiently well in terms of time-domain performance criteria or the system's linearized model is used as in [14] to further develop P or PI controller structures based on the frequency domain analysis (Root Locus) of the linearized system. Both of these implementations lack some important issue.

First of all, the controller parameters are set without any optimization based on experience hence none of the performance criteria in time-domain are considered. Secondly the number of scenarios to create the controller structures seems to be insufficient for both studies. For example, in [14] system identification process of the non-linear system to approximate it as a linear system is handled in a wide range of angular speed span of the BLDC motor. The identification process is done as follows: the motor is driven by a rated current starting from stand still position (motionless) and as the result the motor reaches to the rated speed value in a time range. The corresponding data was used in the system identification process. This identification process might give unsatisfactory results as the non-linearity of the system increases.

A better idea can be using linearization in different speed ranges separately. Similarly, the FLC's efficiency is tested only for a few scenarios where the number of speed span is limited. It is possible to increase the efficiency of the FLC by accounting more speed ranges into consideration and defining a suitable

parameter update procedure to handle all of these ranges. For these reasons, an optimization process is defined to equip these controllers with sophisticated characteristics.

3.1 Controllers

The working principle of both PI and FLC are similar. At the beginning the set value and actual value of the controlled variable are subtracted from each other to obtain an error signal. Then the error signal goes through a mathematical process which creates the manipulated signal that drives the plant.

The aim of this process is to make set value and the actual value of the controlled variable as close as possible. As the process requires a repetitive comparison of the set and actual value of the controlled signal, it is called as a feedback control process. The structure of the control process for a PI controller and a FLC are given in Figures 3 and 4 respectively.

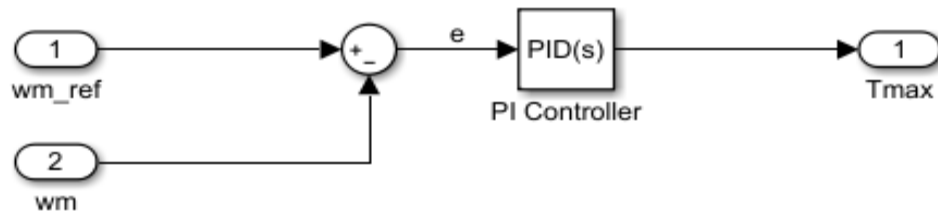

Figures 3: The structure of the PI Controller

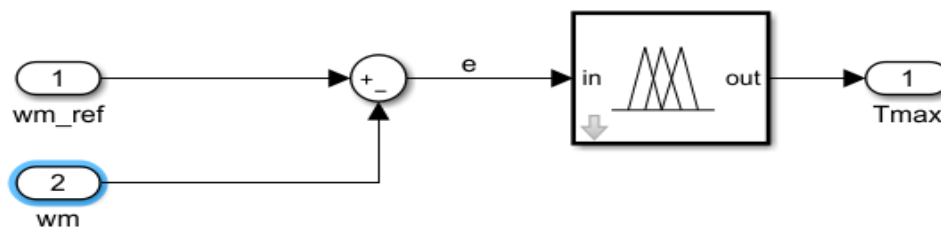

Figures 4: The structure of the FLC

In Figure 3 and 4, controlled variable is the angular speed of the motor ' w_m '. The reference set value of the controlled variable is ' w_{m_ref} '. The error signal ' e ' is simply obtained by subtracting w_m from ' w_{m_ref} '. The controller processes the error signal and as the result ' T_{max} ' the torque value that is driving the BLDC motor is obtained. In Figure 5 the inner structure of the FLC controller is given. FLC controller has 3 parameters, these are ' N_{e1} ', ' N_{e2} ' and ' N_u '. These parameters are

normalization factors and they should be selected wisely in order to increase the performance of the FLC.

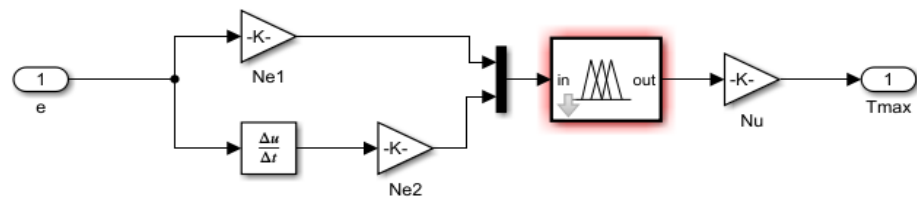

Figure 5: The Inner Structure of the FLC

The structure of the PI controller is much simpler than FLC. The controller takes the error signal ‘e(t)’ as input and as the result it produces the output signal T_{max} . The mathematical relation between e(t) and T_{max} is given in Equation 1 as;

$$T_{max} = P e(t) + I \int_0^t e(t) dt \quad (1)$$

where ‘P’ is the proportional gain and ‘I’ is the integral gain parameters of the PI controller.

When the PI controller or FLC is employed, the closed loop system structure becomes as in Figure 6 (in case PI controller is used) and Figure 7 (in case FLC is used).

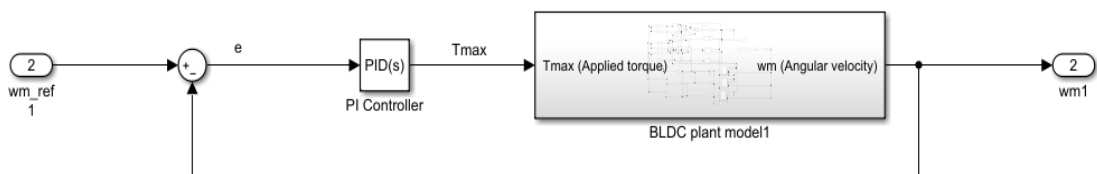

Figure 6: Closed loop PI control for the angular speed of the BLDC Motor

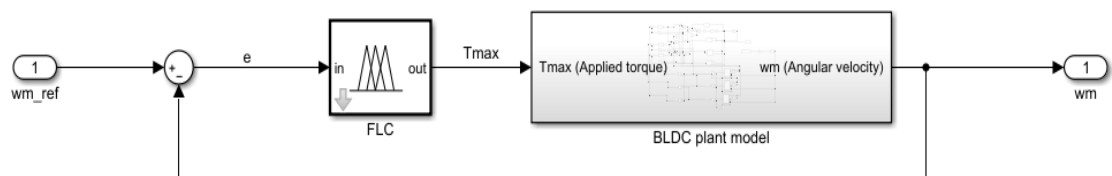

Figure 7: Closed loop FLC control for the angular speed of the BLDC Motor

3.2 Step Responses

In order to examine the time domain performance of a stable system there are 4 critical performance index (criteria). These are rise-time, settling time, maximum overshoot and steady-state error value. These criteria are obtained from the output signal which exhibits stable characteristics due to application of a reference signal resembling a step input. As the reference signal is applied the controller manipulates the control signal that drives the plant and output is obtained. If the closed loop system is stable, the response shape will be similar to the one in Figure 8 where each performance criteria are is demonstrated graphically. For a properly working controller, from these performance criteria the settling time value and rise-time value should be as small as possible to guarantee a fast response structure. Besides the steady-state error value which is the difference between the reference signal and the steady-state value of the response should approach to 0. Finally, the maximum-overshoot value which is the percentage ratio of the difference between the peak value of the response and the steady-state value of the response to steady-state value of the response should also be minimized.

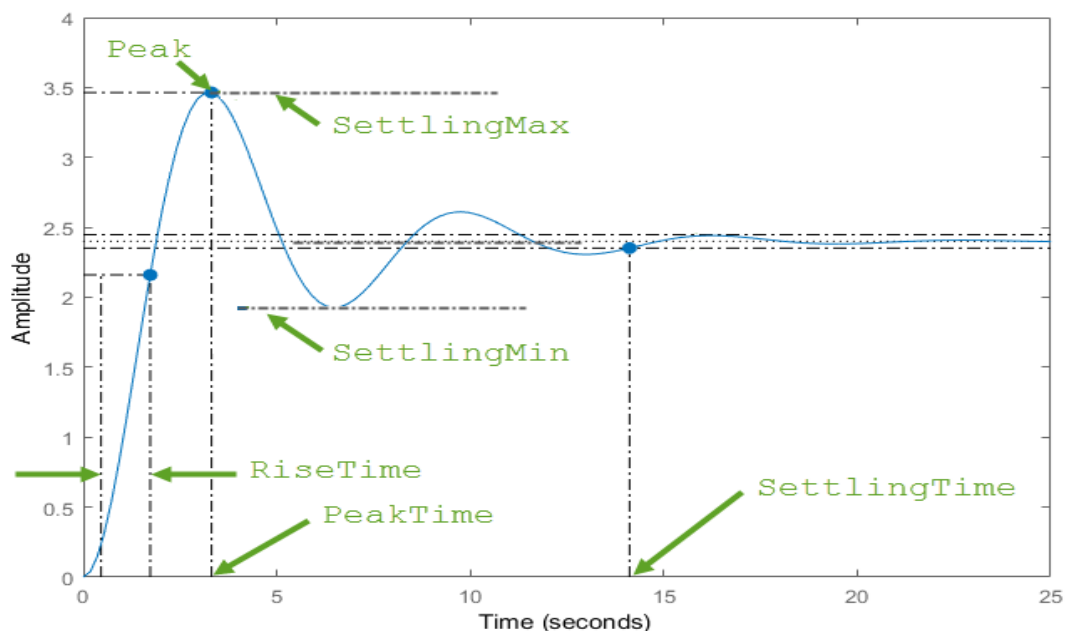

Figure 8: Step Response [16]

CHAPTER 4

GENETIC ALGORITHM

4.1 Explanation of Genetic Algorithm

Genetic Algorithms (GA) is an optimization method taking its roots from the mechanism of survival of the species in nature. This mechanism can be explained by a single rule: the destruction of bad generations and genes while the good generations and genes protect themselves and have the ability to carry their characteristics to the new generations. GA is used for optimization problems where the mathematical modeling cannot be properly made or there is no definite solution.

GA use operators such as fitness function, crossover and modification to produce new solutions. One of the important features of the GA is that it seeks the solution on a group and thus selects the best from a large number of solutions. In other words, GA is an intuitive search technique based on parameter coding that tries to find solutions using random search techniques. GA application areas are Optimization, Automatic Programming, Information Systems, Image processing, Mechanical Learning, Finance and marketing etc. [15]. The parameters used in GA search and the values of these parameters should be determined properly in order to achieve success.

4.1.1. Gen:

In GA, the smallest structural unit that carries genetic information on its own is called a gene. Combining these small structures with partial information, the chromosome (sequence) forms an entire solution set.

In an optimization process where GA is used, the gene structures depend on the defined optimization problems' variables. The information contained in a gene describes these variables in the form of either binary numbers or decimal numbers or

hexadecimal numbers. Therefore, according to the optimization problem, the gene content is very important and it can change due to coding of the variable [15].

4.1.2. Chromosome:

When one or more gene structures come together and they form a chromosome and the chromosome contain all the information related to the solution of the problem. Chromosomes come together to create a population which is a group of different solutions. Each chromosome is also called an individual of the population and it is a candidate for the solution of the optimization problem [15].

4.1.3. Population:

Population is called a possible solution stack formed by the combination of chromosome. The number of chromosomes in the population is generally fixed and is determined depending on the size of the optimization problem [15].

Operators that determine the functioning of GA and influence the success of GA are as follows;

1. Initial population
2. Fitness function
3. Selection
4. Crossover
5. Mutation

4.2 Application of Genetic Algorithm

In this thesis, GA is used as the optimization method that is employed to minimize a multi-criteria cost function which is calculated as weighted sum of the performance criteria of the step response of the BLDC plant model when either PI controller or FLC is used to control the plant. In case the controller structure is a PI controller a chromosome will contain two genes where the first gene is the proportional gain value P and the second gene is the integral gain value I of the controller. These

values are also given in Equation 1. In this context, a PI controller has a chromosome structure as in Figure 9.

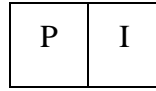

Figure 9: The structure of a chromosome representing a PI controller.

Similarly, if a FLC is used, this time the controller structure should have three genes that are the normalization factors shown in Figure 5. Hence the FLC structure can be coded as the chromosome shown in Figure 10.

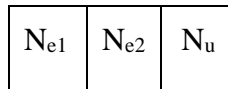

Figure 10: The structure of a chromosome representing a FLC controller.

Each of these chromosomes are indeed coded versions of the controller structure they are representing. The controller defined by the chromosome drives the plant in the closed loop system model shown in Figures 6 or 7 (according to the controller structure determined) and as the result, for a specific step input type reference signal they produce the system response (output) which is the angular speed of the BLDC motor. The response is examined and corresponding rise time, settling time, maximum overshoot, steady-state error and undershoot values are recorded (undershoot is similar to overshoot however undershoot occurs generally in the early steps of the step response and is oriented towards the opposite direction to overshoot). The GA cost function is defined as a weighted sum of each of these five performance criteria as;

$$\text{Cost} = M_1 \times \text{rise_time} + M_2 \times \text{settling_time} + M_3 \times \text{percentage_overshoot} + M_4 \times \text{percentage_steady_state_error} + M_5 \times \text{undershoot} \quad (2)$$

In Equation 2, M_1 to M_5 represents the weights of each performance criteria respectively.

From these performance criteria, rise time (rise_time) is defined as the time required for the response to reach from 10% to 90% of its steady-state value. For the settling time (settling_time), band where the output function gets into 5% neighborhood of its steady-state value is used. Steady-state value of the response is necessary for determining rise time and settling time values. It is observed that the outputs due to step response for the nonlinear system demonstrate fluctuations as the response

reaches to its steady-state value. Hence the steady-state value of the response is defined as the average of the output values calculated for the last 10% of the total simulation duration and that resulting value is recorded as the steady-state value. For percentage steady-state error value (percentage_steady_state_error) the formula below is employed.

$$percentage_steady_state_error = \frac{|reference_value - steady_state_value|}{|reference_value - initial_velocity|} \times 100 \quad (3)$$

In order to calculate percentage_overshoot the formula given below is used;

$$percentage_overshoot = \frac{|peak_value - steady_state_value|}{|steady_state_value - initial_velocity|} \times 100 \quad (4)$$

Undershoot is calculated similar to maximum-overshoot (throughout simulations undershoot values are always obtained very close to 0).

After the Cost is obtained for a chromosome in a specific speed range, the fitness of the chromosome at that specific speed range is calculated using reciprocal of the cost function.

$$Fitness_{speed_range_i} = \frac{1}{Cost} \quad (5)$$

With this cost function settings, different optimization procedures are carried out: The first group of optimizations are carried out to find best suiting PI controller structure that drives the BLDC motor in different speed ranges separately. This approach is named as Single PI approach. For this approach Equation 5 is used to calculate the fitness of a chromosome. For the second group of optimization, instead of composing different PI controllers for different speed ranges it is intended to develop as single controller for all the speed ranges altogether: this approach is called as Multiple PI approach. And finally, to develop a strong FLC control with a fixed rule-base whose structure is given in Table 2, a similar approach to Multiple PI approach is carried out which is named as Multiple FLC approach. The details of the rule-base structure given in Table 2 and how the rule-base structure interpolates the data are explained in [14].

Table 2: Rule base structure of the FLC controller [14].

e_1 and e_2	PB	PM	PS	Z	NS	NM	NB
PB	PB	PB	PM	PM	PS	PS	Z
PM	PB	PM	PM	PS	PS	Z	NS
PS	PM	PM	PS	PS	Z	NS	NS
Z	PM	PS	PS	Z	NS	NS	NM
NS	PS	PS	Z	NS	NS	NM	NM
NM	PS	Z	NS	NS	NM	NM	NB
NB	Z	NS	NS	NM	NM	NB	NB

For Multiple PI approach and Multiple FLC approach controller is developed accounting all the speed ranges into account together in the optimization process. Hence, the GA fitness function defined in Equation 5 is changed; the new fitness function calculates the summation of the fitness values obtained for each separate speed range. Thus, the fitness of a chromosome for Multiple PI and Multiple FLC approaches is defined as;

$$Fitness = \sum_{i=1}^7 Fitness_{speed_range_i} \quad (6)$$

Where $Fitness_{speed_range_i}$ represents the fitness value of the chromosome calculated for the i^{th} speed range (7 speed ranges are defined). Hence the fitness of a chromosome is summation of all the fitness values in each speed ranges. For controllers which are developed using multiple approach (either Multiple PI or Multiple FLC), 7 different speed ranges are employed in the optimization phase (Case 1) and 5 different speed ranges are used as validation phases (Case 2). On the other hand, for Single PI approach all the 7 controllers are developed only considering their associated speed range in the optimization phase (Case 1). However, only 5 of these controllers are examined in validation phase (Case 2). These speed ranges of the optimization phase and validation phase are given in Table 3 and Table 4 respectively. The speed ranges emphasizes the initial angular velocity value and the final (reference) angular velocity value of the step input signal applied to the closed loop system as input for the blocks defined in Figure 6 and Figure 7.

Table 3: Speed Ranges Case 1 (used in optimization phase)

CASE 1	Initial angular speed value (rad/sec)	Final angular speed value (reference speed) (rad/sec)
Speed range 1	0	20
Speed range 2	20	40
Speed range 3	0	100
Speed range 4	0	400
Speed range 5	200	400
Speed range 6	380	400
Speed range 7	300	350

Table 4: Speed Ranges Case 2 (used in validation phase)

CASE 2	Initial angular speed value (rad/sec)	Final angular speed value (reference speed) (rad/sec)
Speed range 1	40	20
Speed range 2	-20	-40
Speed range 3	0	-400
Speed range 4	400	380
Speed range 5	-380	-400

The optimization simulations are compared with the results obtained in [14]. For optimization simulations in Multiple FLC approach to speed up the optimization process, a fixed step size of 0.001 seconds is used with Runge-Kutta Solver. For

Multiple and Single PI approaches as the computation is faster compared to FLC a fixed step size 0.0001 (ten times smaller than Multiple FLC approach) seconds is used with Runge-Kutta Solver. However, for a fair comparison, at the end, all the developed controllers and the controller produced in [14] are run with a fixed step size of 0.00001.

The simulations are carried out with the following parameters for Single PI, Multiple PI and Multiple FLC:

Number of generations: 100,

Number of chromosomes in each generation: 100

Mutation rate: 0.04

Reproduction rate: 0.06 (with elitism method)

Crossover rate: 0.9

In the formation of the initial population for FLC the parameter ranges are taken as $0.001 \leq N_{e1} \leq 1$, $0.5 \times 10^{-7} \leq N_{e1} \leq 1$ and $1 \leq N_{e1} \leq 6000$. These ranges are determined based on the values of the same parameters in [14] which cover at least 4 times the ranges they cover in [14]. Similarly, in formation of the initial population for PI controller parameter ranges are taken as $0 \leq P \leq 1000$, $0 \leq I \leq 1000$.

The weight values of the cost function for all controller developed are taken as;

$M_1=1000$, $M_2=1000$, $M_3=10$, $M_4=100000$, $M_5=1$

In order to guarantee that a positive cost function is obtained (that is necessary to maintain a non-negative fitness value for each chromosome) M_1 up to M_5 should all have positive numerical values. Otherwise due to the selection of the fitness function given in Equation 6, negative fitness values can be encountered for some chromosomes and this will disturb the progress of GA search. In reality M_1 up to M_5 are determined as the result of trial and error: In the early optimization simulations after GA search is finished, the comparative impact of each performance criteria over the cost function is monitored. Due to this data M_1 up to M_5 values are updated.

4.3 PI Test Result (With GA Single) Table

Table 5: Best Chromosomes for PI (GA Single) Controller

Test Results_PI	0-20		20-40	
fitness_best	1.3163e-04		6.3370e-05	
population_best (P&I)	426.6227	16.3825	400.0572	386.7493
[fitness,cost]	8.8879e-05	1.1251e+04	4.7566e-05	2.1024e+04

Test Results_PI	0-100		0-400	
fitness_best	1.1118e-04		1.3408e-04	
population_best (P&I)	353.6439	0.8086	429.7182	0.7383
[fitness,cost]	8.9432e-05	1.1182e+04	4.2263e-05	2.3661e+04

Test Results_PI	200-400		300-350	
fitness_best	5.9707e-05		1.7100e-05	
population_best (P&I)	721.1782	30.6848	890.0671	304.5454
[fitness,cost]	4.1404e-05	2.4152e+04	1.3413e-05	7.4555e+04

Test Results_PI	380-400			
fitness_best	6.3948e-06			
population_best (P&I)	578.9623	319.7824		
[fitness,cost]	4.9568e-06	2.0174e+05		

4.4 PI Test Result (With GA Multiple) Table

Table 6: Best Chromosomes for PI (GA Multiple) Controller

Test Results_PI	ALL RANGES	
fitness_best	4.9769e-04	
population_best (P&I)	820.0666	42.7608

4.5 FLC Test Result (With GA Multiple) and Optimization&Validation Tables

Table 7: Best Chromosomes for FLC (GA Multiple) Controller

Test Results_FLC	ALL RANGES		
fitness_best	7.8391e-07		
population_best (P&I)	0.0006	9.4145	0.0518
Ne1,Ne2,Nu 1/K1,1/K2,K3	56.4749	941450	5183.9

4.6 Optimization&Validation Table for All Controllers

Table 8: Optimization&Validation Parameters for All Controllers

	FLC[14], PI(R.L)[14]	PI (GA) (Single), PI (GA) (Multiple)	FLC (GA) (Multiple)	FLC (GA) (Multiple) Norm 1&2
Opt.	--	0.0001	0.001	0.0001
Val.	0.00001	0.00001	0.00001	0.00001

CHAPTER 5

THE PERFORMANCE INDICES OF CONTROLLERS

The most appropriate P and I coefficients obtained by Single PI Approach and Multiple PI Approach and Ne1, Ne2 and Nu coefficients obtained by Multiple FLC approach (the results of the optimization simulations) are used in the controllers and corresponding angular speeds (outputs) are obtained. These outputs are compared with the outputs that were obtained by the PI and FLC controller developed previously in [14] (the controllers are named as FLC[14] and PI(R.L)[14]). In this chapter 'CASE 1' represents the optimization results and 'CASE 2' represents validation results for the speed ranges given in Table 3 and Table 4 respectively.

5.1. CASE 1 [(0)-(20)], [(20)-(40)], [(0)-(100)], [(0)-(400)], [(200)-(400)], [(300)-(350)], [(380)-(400)]

5.1.1. FLC [14] 0-20

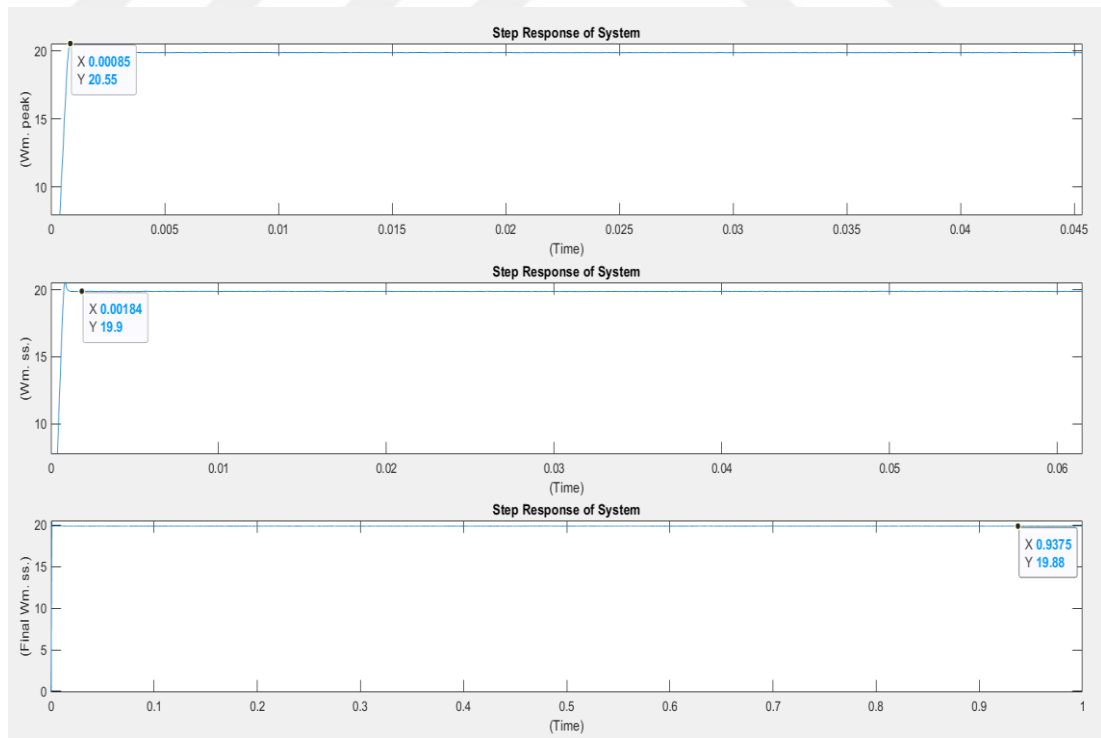

Figure 11: FLC [14] 0-20 (Wm_peak(rad/sec):20.55, tr (sec.):0.0008, Wm_ss(rad/sec):19.9 , ts (sec.):0.0018, Final Wm_ss(rad/sec):19.88)

5.1.2. PI (R.L) [14] 0-20

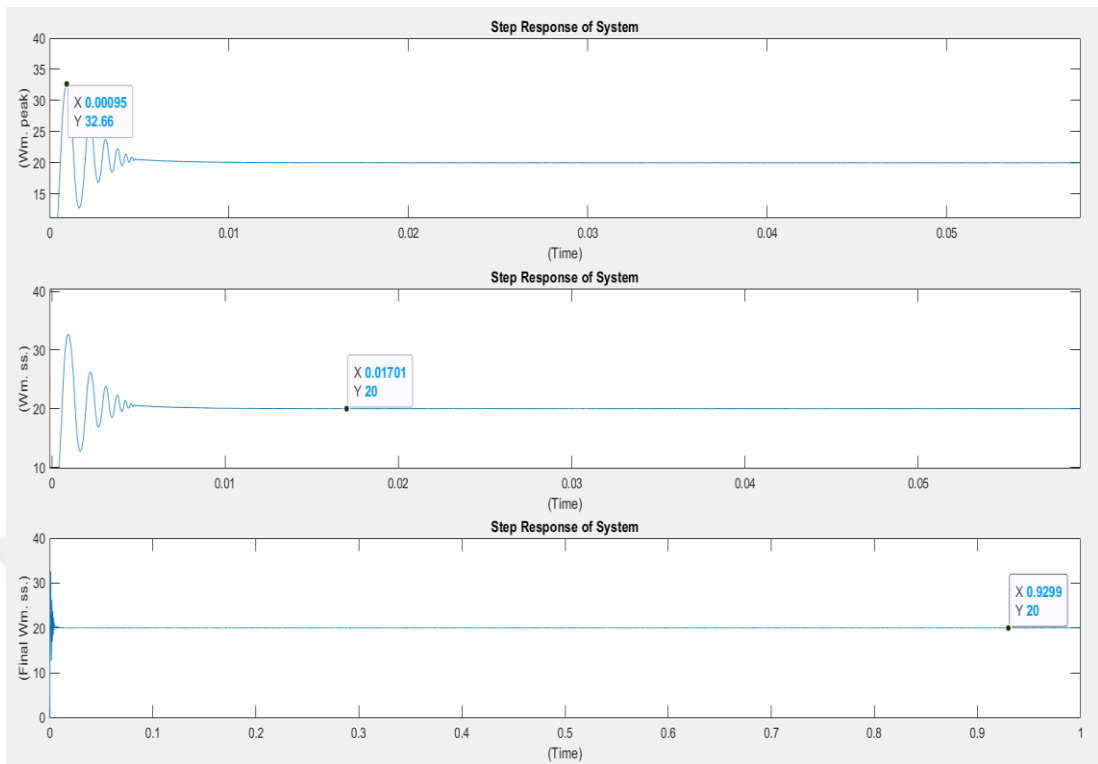

Figure 12: PI(R.L)[14] 0-20 (Wm_peak(rad/sec):32.66 , tr (sec.):0.0009,
Wm_ss(rad/sec):20 , ts (sec.):0.017, Final Wm_ss(rad/sec):20)

5.1.3. PI (GA)(Single) 0-20

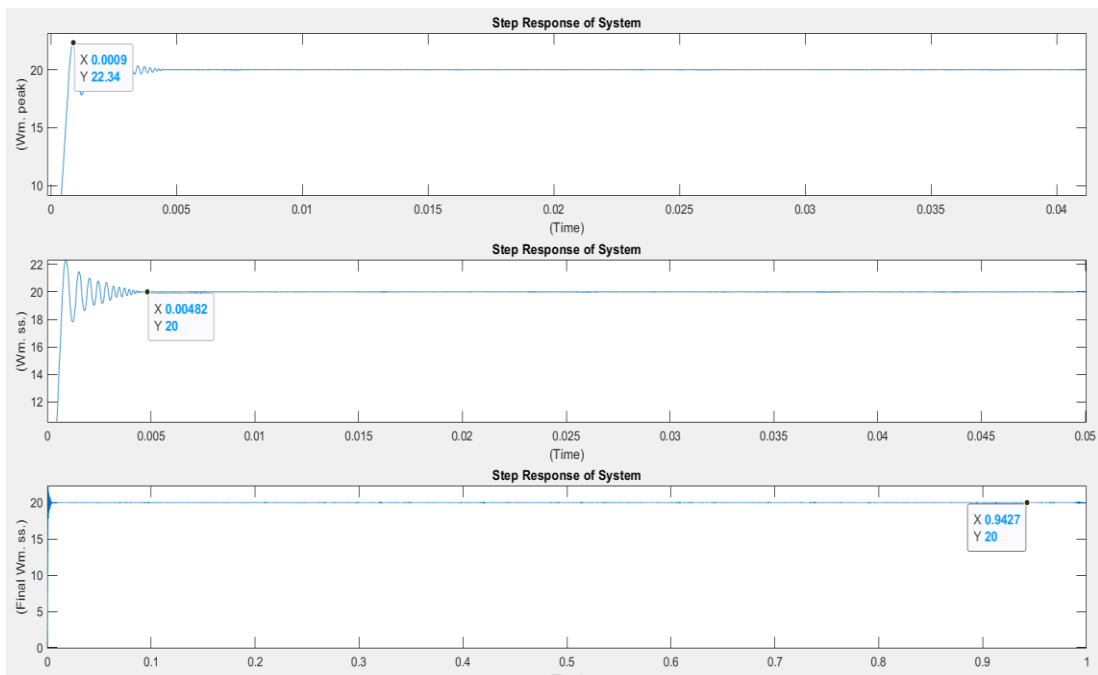

Figure 13: PI (GA)(Single) 0-20 (Wm_peak(rad/sec):22.34, tr (sec.):0.0009,
Wm_ss(rad/sec):20, ts (sec.):0.0048, Final Wm_ss(rad/sec):20)

5.1.4. PI (GA)(Multiple) 0-20

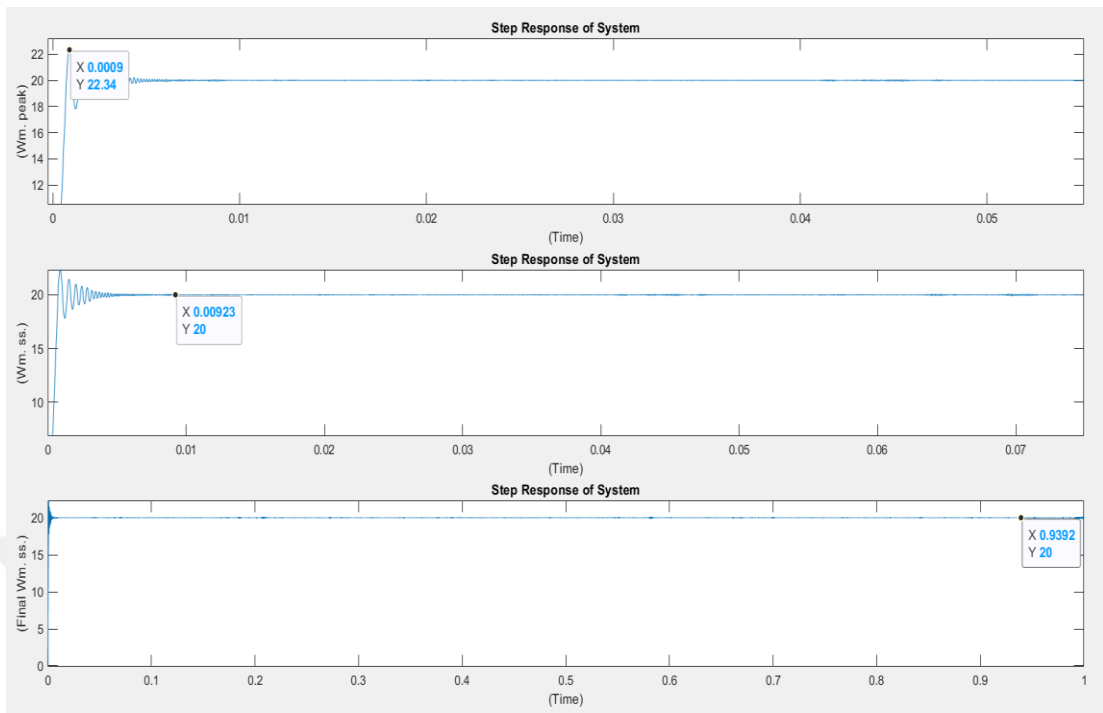

Figure 14: PI (GA)(Multiple) 0-20 (Wm_peak(rad/sec):22.34, tr (sec.):0.0009, Wm_ss(rad/sec):20, ts (sec.):0.0092, Final Wm_ss(rad/sec):20)

5.1.5. FLC (GA) (Multiple) 0-20

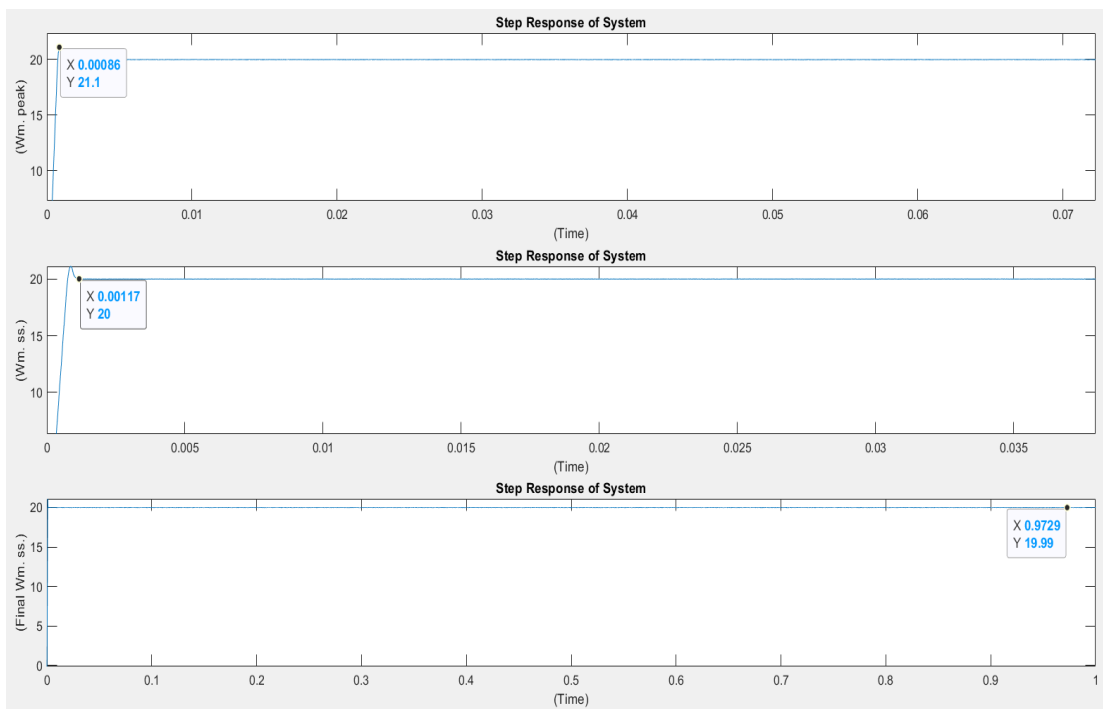

Figure 15: FLC (GA) (Multiple) 0-20 (Wm_peak(rad/sec):21.1, tr (sec.):0.0008, Wm_ss(rad/sec): 20, ts (sec.):0.0011, Final Wm_ss(rad/sec):19.99)

5.1.6. FLC[14] 20-40

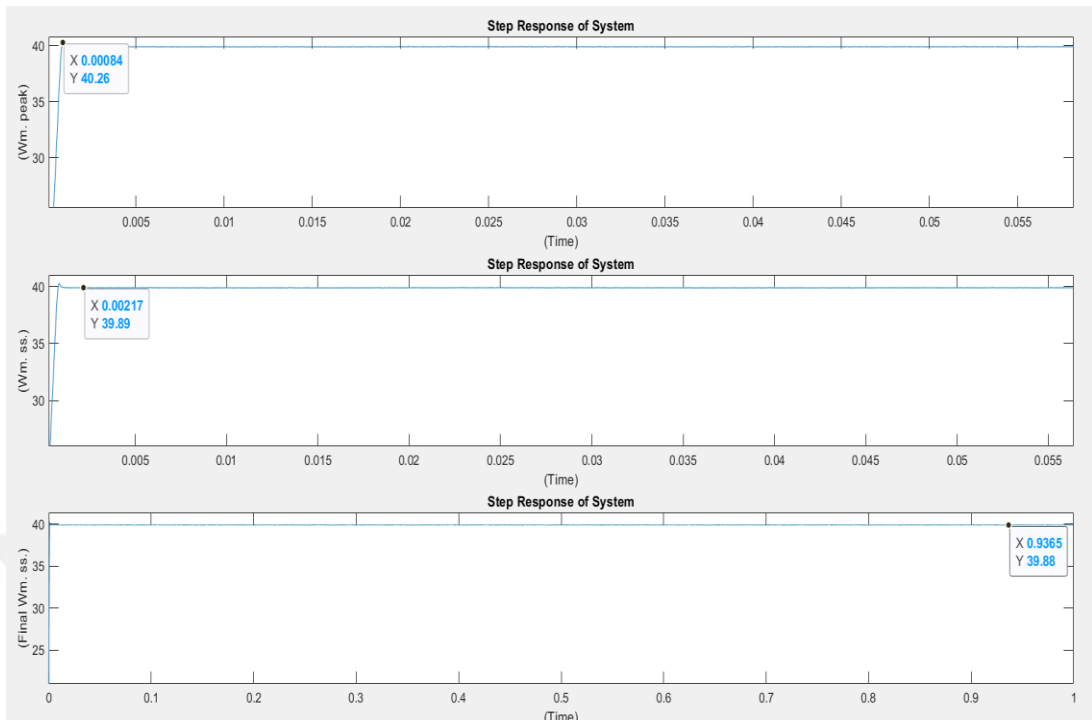

Figure 16: FLC[14] 20-40 (Wm_peak(rad/sec):40.26, tr (sec.):0.0008, Wm_ss(rad/sec): 39.89, ts (sec.):0.0021, Final Wm_ss(rad/sec):39.88)

5.1.7. PI(R.L)[14] 20-40

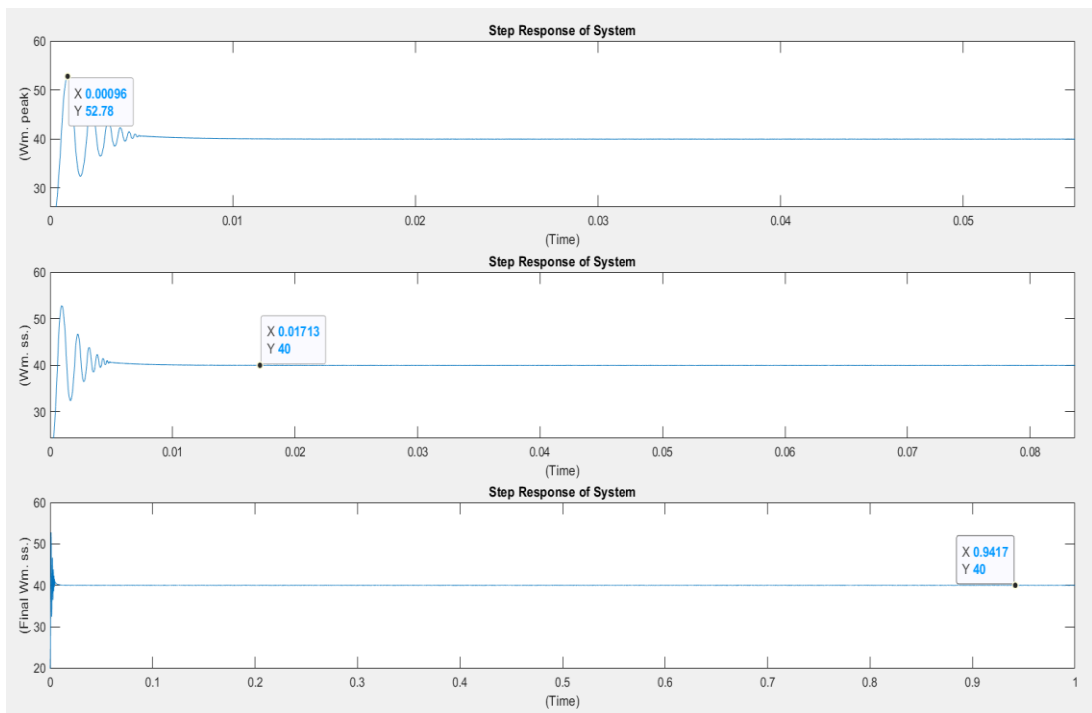

Figure 17: PI(R.L)[14] 20-40 (Wm_peak(rad/sec):52.78, tr (sec.):0.0009, Wm_ss(rad/sec): 40, ts (sec.):0.017, Final Wm_ss(rad/sec): 40)

5.1.8. PI (GA)(Single) 20-40

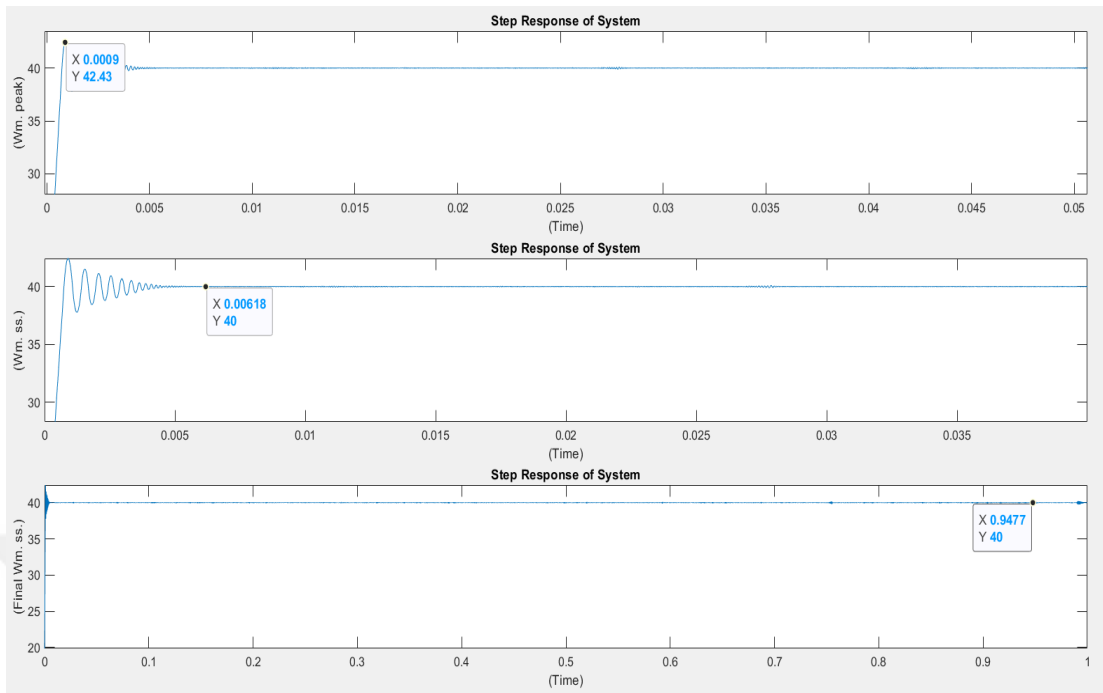

Figure 18: PI (GA)(Single) 20-40 (Wm_peak(rad/sec): 42.43, tr (sec.): 0.0009, Wm_ss(rad/sec):40, ts (sec.): 0.0061, Final Wm_ss(rad/sec): 40)

5.1.9. PI (GA)(Multiple) 20-40

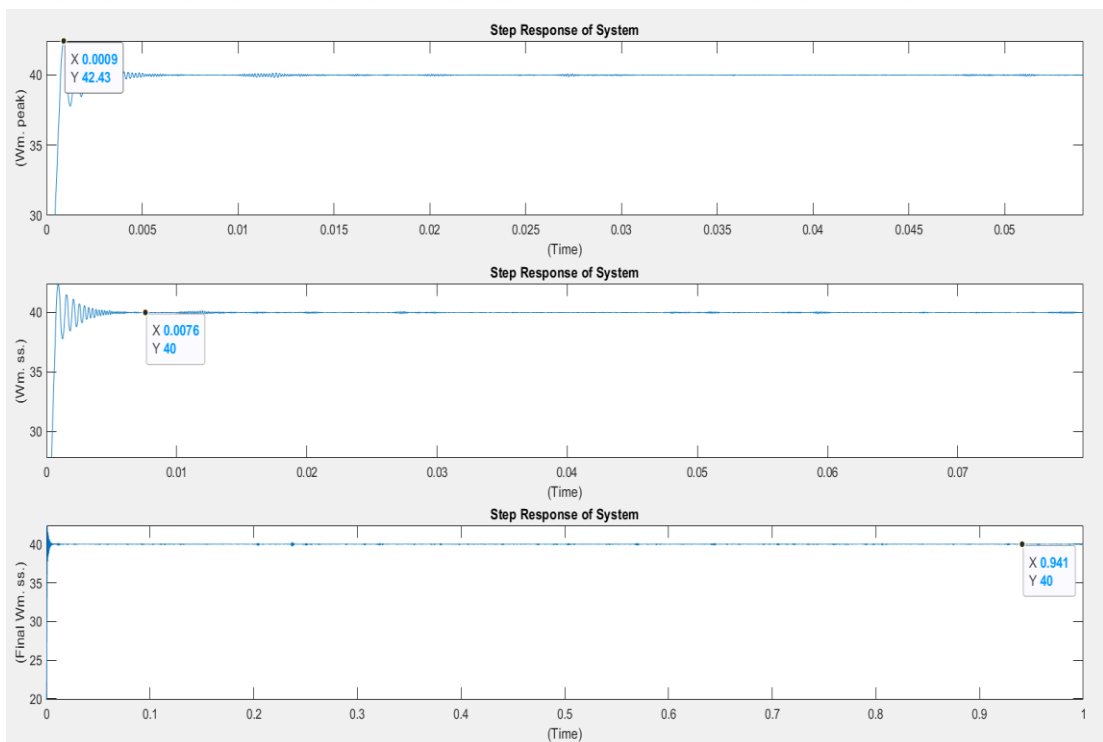

Figure 19: PI (GA)(Multiple) 20-40 (Wm_peak(rad/sec): 42.43, tr (sec.): 0.0009, Wm_ss(rad/sec): 40, ts (sec.): 0.0076, Final Wm_ss(rad/sec): 40)

5.1.10. FLC (GA)(Multiple) 20-40

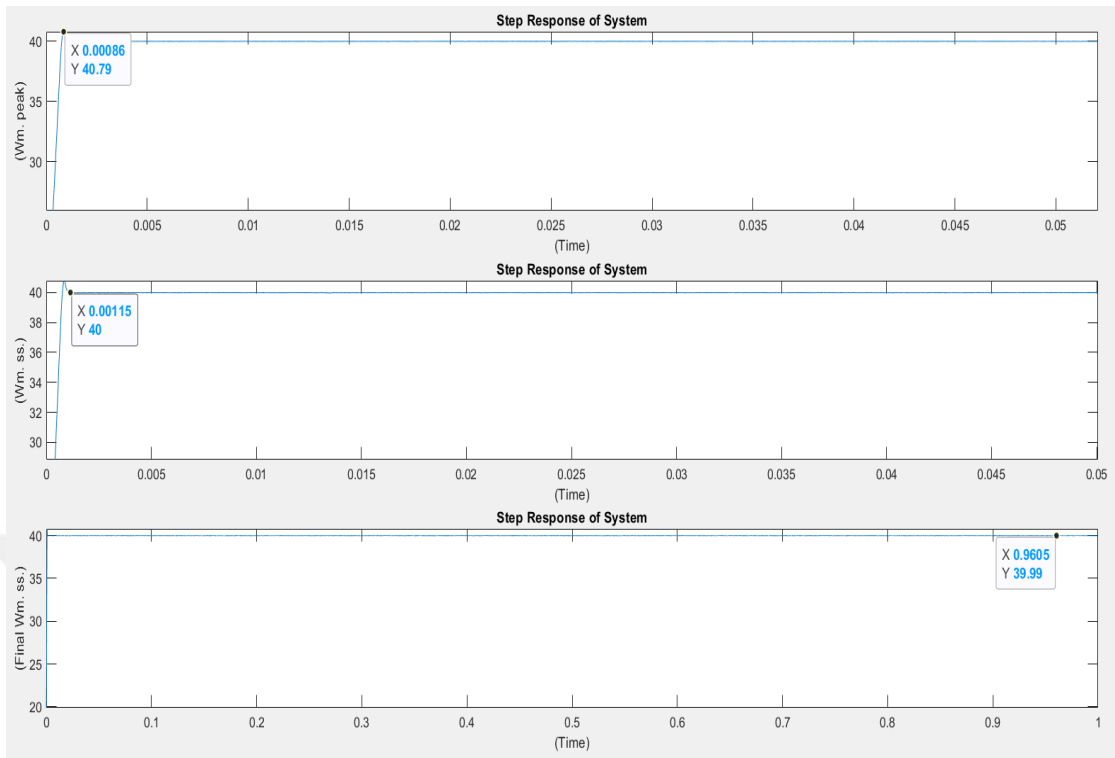

Figure 20: FLC (GA) (Multiple) 20-40 (Wm_peak(rad/sec): 40.79, tr (sec.): 0.0008, Wm_ss(rad/sec): 40, ts (sec.): 0.0011, Final Wm_ss(rad/sec): 39.99)

5.1.11. FLC[14] 0-100

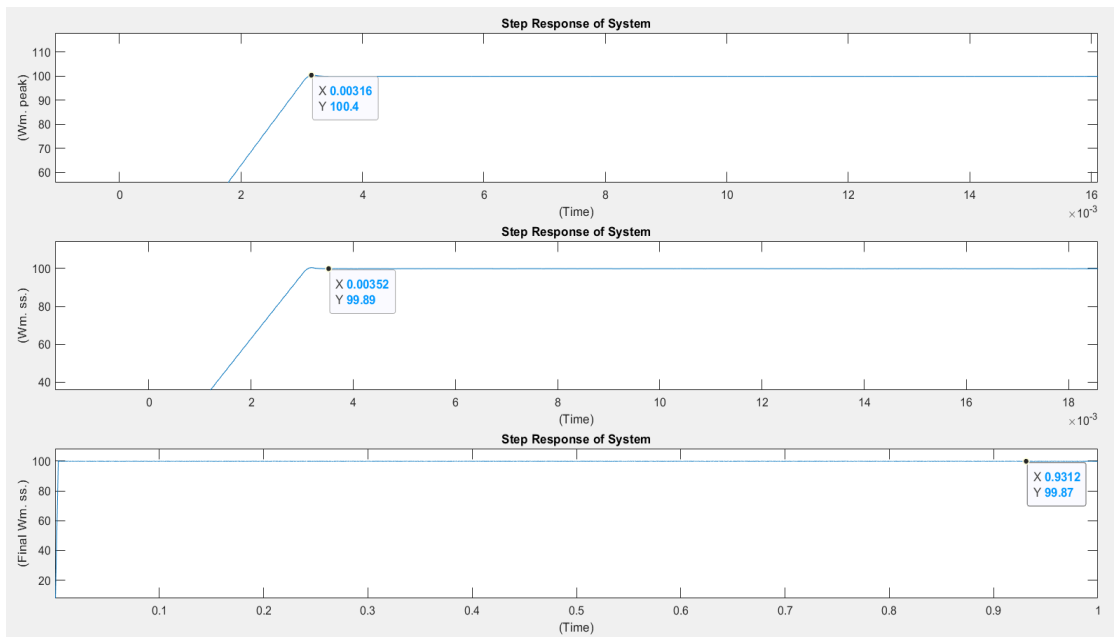

Figure 21: FLC [14] 0-100 (Wm_peak(rad/sec): 100.4, tr (sec.): 0.0031, Wm_ss(rad/sec): 99.89, ts (sec.): 0.0035, Final Wm_ss(rad/sec): 99.87)

5.1.12. PI(R.L)[14] 0-100

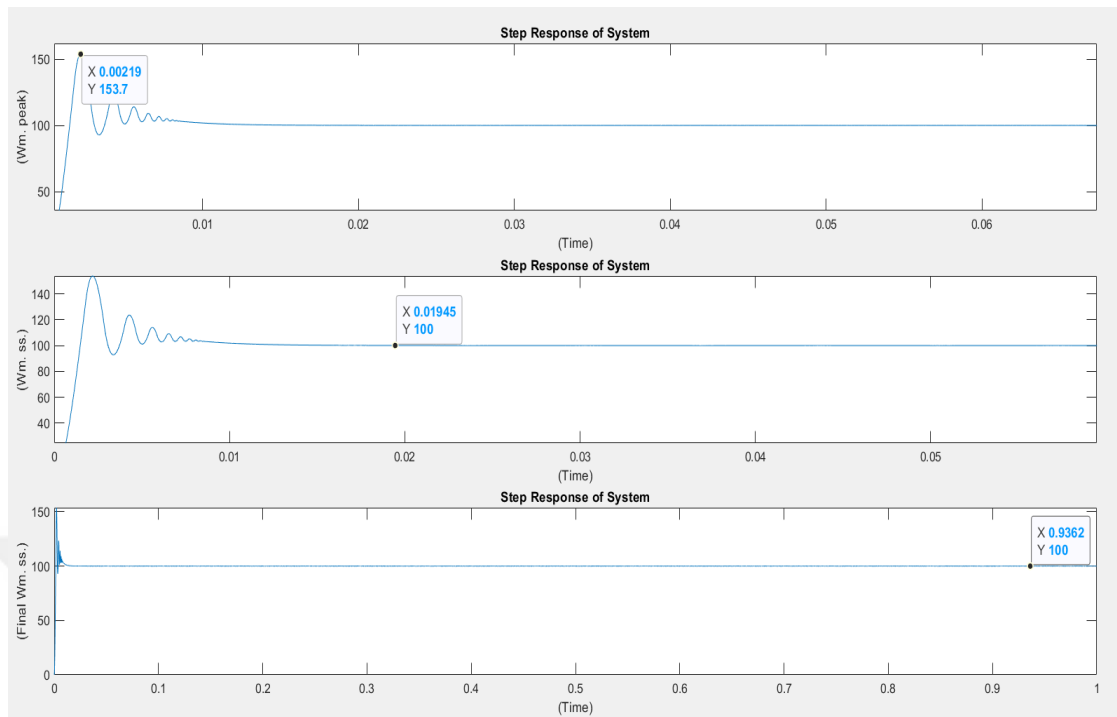

Figure 22: PI(R.L)[14] 0-100 (Wm_peak (rad/sec): 153.7, tr (sec.): 0.0021, Wm_ss (rad/sec): 100, ts (sec.): 0.019, Final Wm_ss (rad/sec): 100)

5.1.13. PI (GA)(Single) 0-100

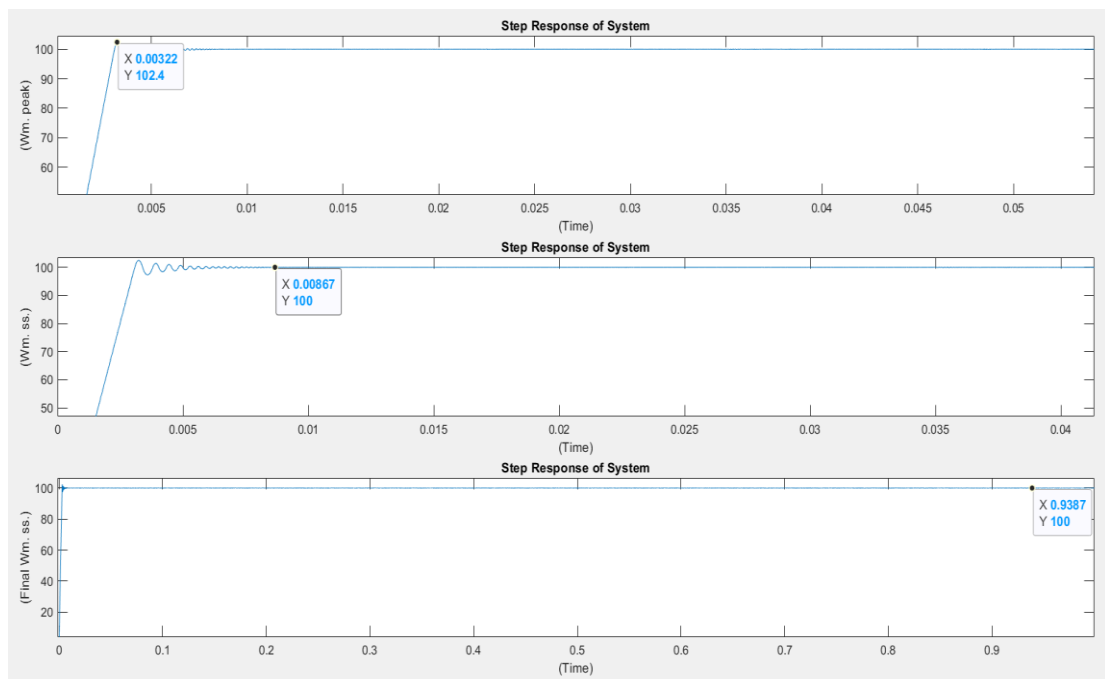

Figure 23: PI (GA)(Single) 0-100 (Wm_peak (rad/sec): 102.4, tr (sec.): 0.0032, Wm_ss (rad/sec): 100, ts (sec.): 0.0086, Final Wm_ss (rad/sec): 100)

5.1.14. PI (GA)(Multiple) 0-100

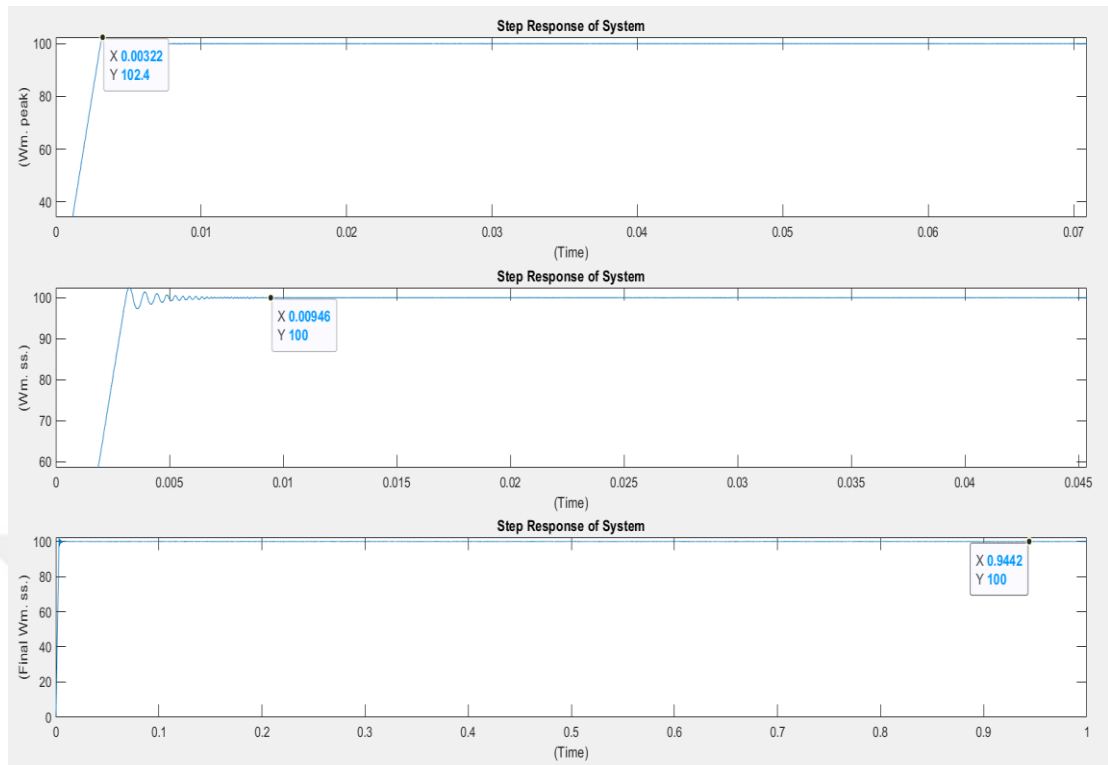

Figure 24: PI (GA)(Multiple) 0-100 (Wm_{peak}(rad/sec): 102.4, tr (sec.): 0.0032, Wm_{ss}(rad/sec): 100, ts (sec.): 0.0094, Final Wm_{ss}(rad/sec): 100)

5.1.15. FLC (GA)(Multiple) 0-100

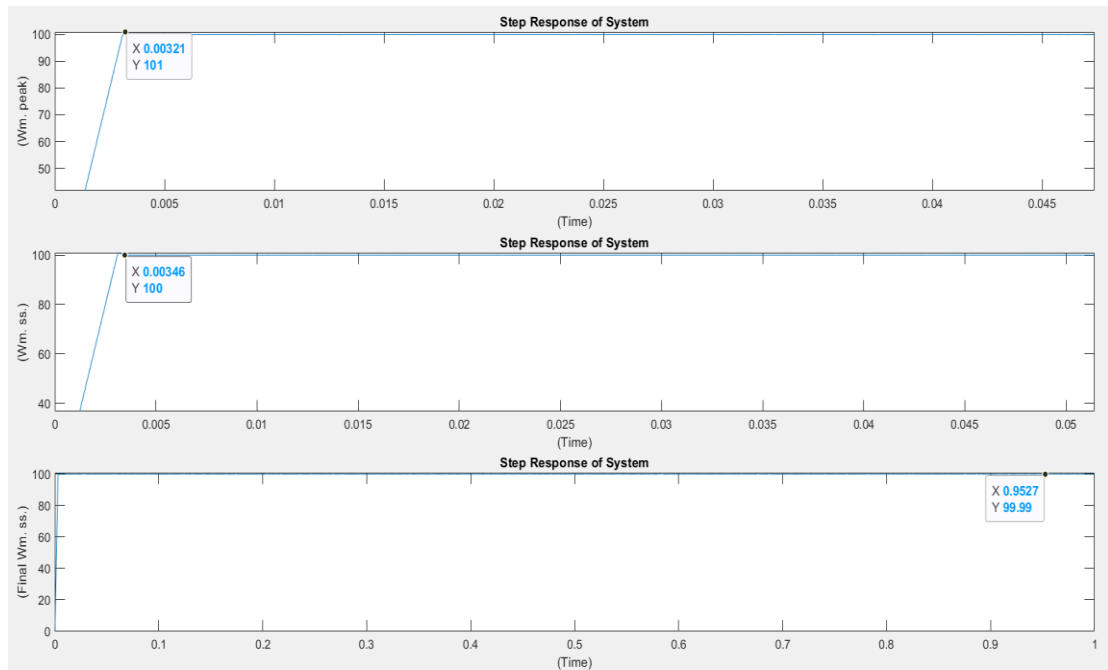

Figure 25: FLC (GA) (Multiple) 0-100 (Wm_{peak}(rad/sec): 101, tr (sec.): 0.0032, Wm_{ss}(rad/sec): 100, ts (sec.): 0.0034, Final Wm_{ss}(rad/sec): 99.99)

5.1.16. FLC[14] 0-400

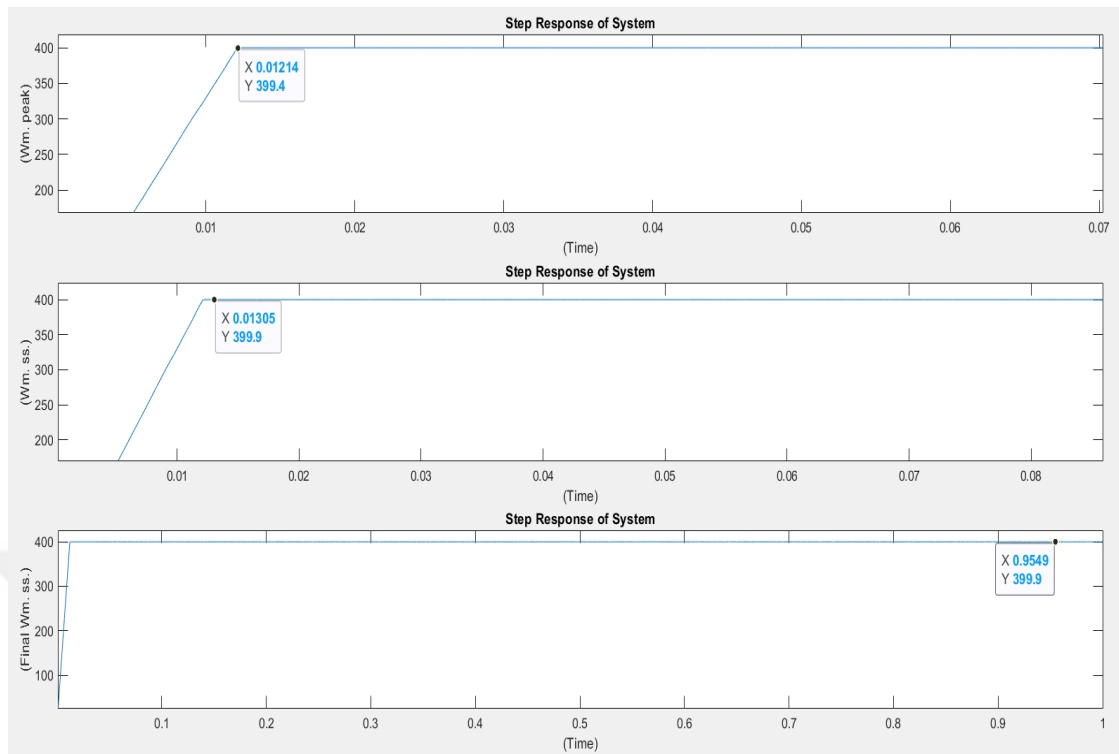

Figure 26: FLC[14] 0-400 (Wm_peak(rad/sec): 399.4, tr (sec.): 0.012, Wm_ss(rad/sec): 399.9, ts (sec.): 0.013, Final Wm_ss(rad/sec): 399.9)

5.1.17. PI(R.L)[14] 0-400

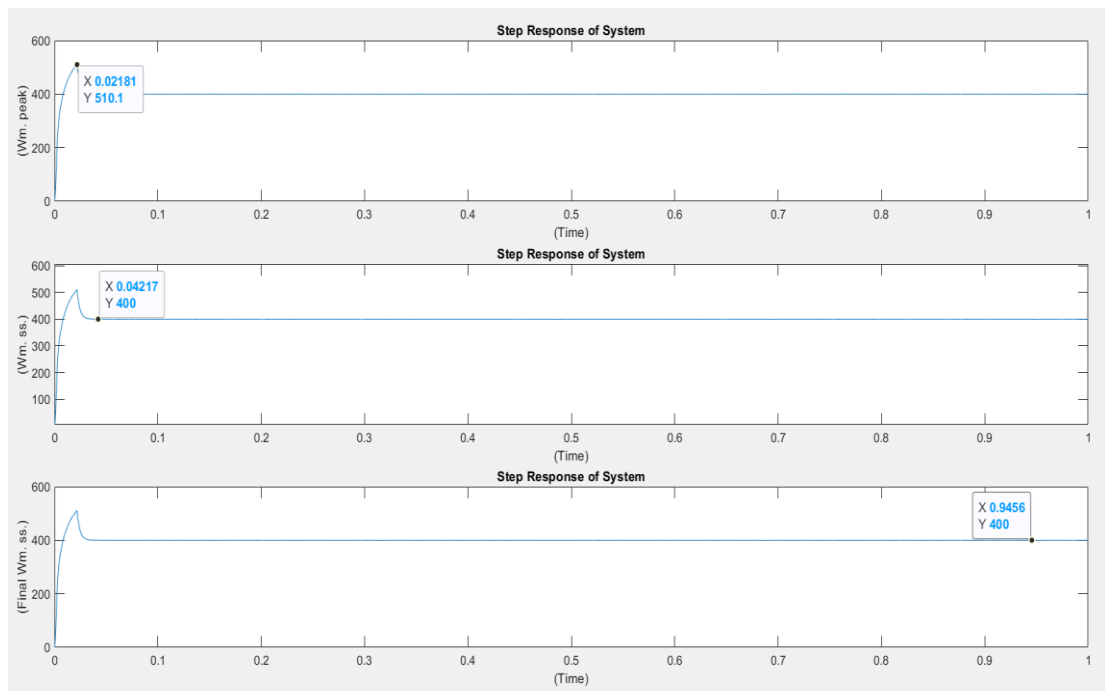

Figure 27: PI(R.L)[14] 0-400 (Wm_peak(rad/sec): 510.1, tr (sec.): 0.021, Wm_ss(rad/sec): 400, ts (sec.): 0.042, Final Wm_ss(rad/sec): 400)

5.1.18. PI (GA)(Single) 0-400

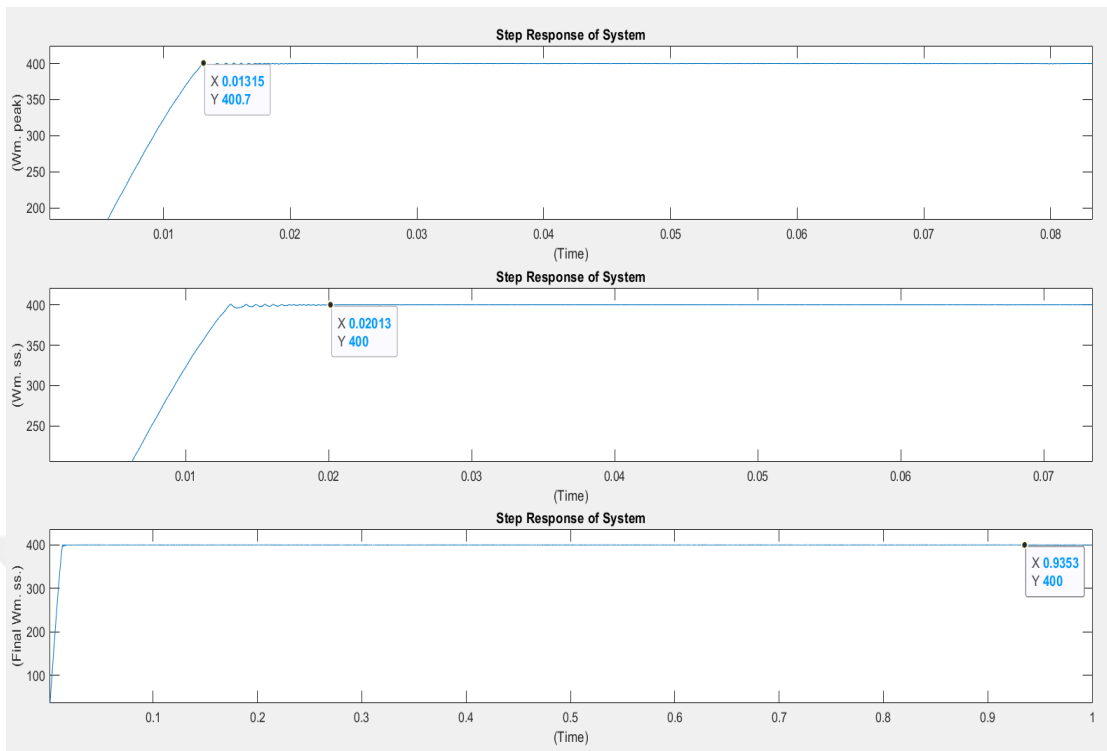

Figure 28: PI (GA)(Single) 0-400 (Wm_peak(rad/sec): 400.7, tr (sec.): 0.013, Wm_ss(rad/sec): 400, ts (sec.): 0.020, Final Wm_ss(rad/sec): 400)

5.1.19. PI (GA)(Multiple) 0-400

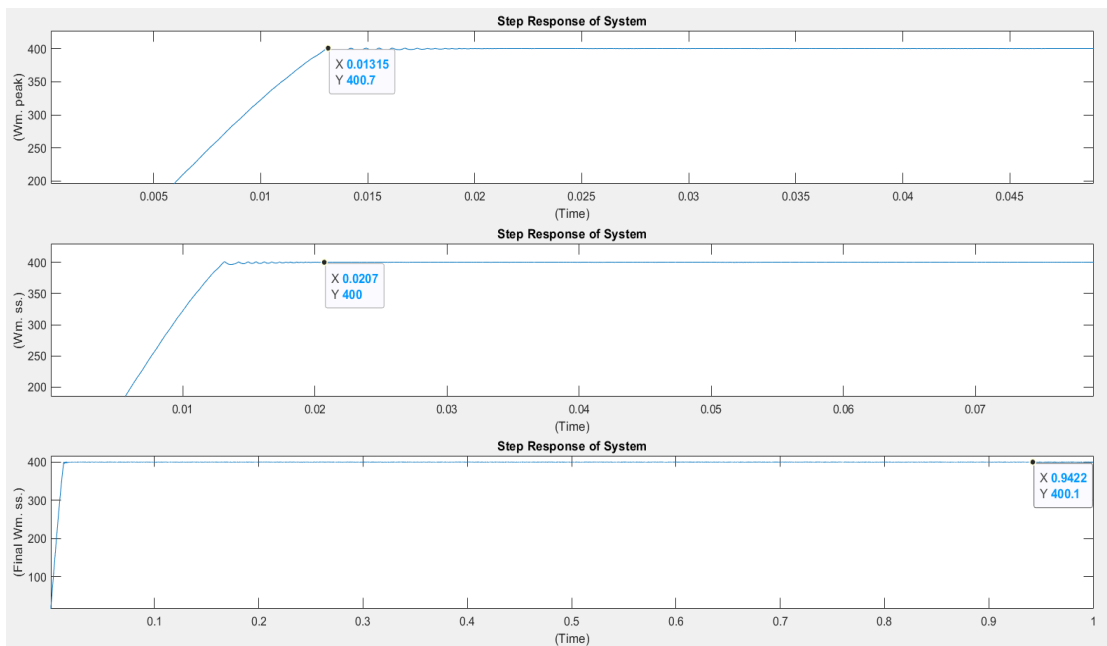

Figure 29: PI (GA)(Multiple) 0-400 (Wm_peak(rad/sec): 400.7, tr (sec.): 0.013, Wm_ss(rad/sec): 400, ts (sec.): 0.020, Final Wm_ss(rad/sec): 400.1)

5.1.20. FLC (GA)(Multiple) 0-400

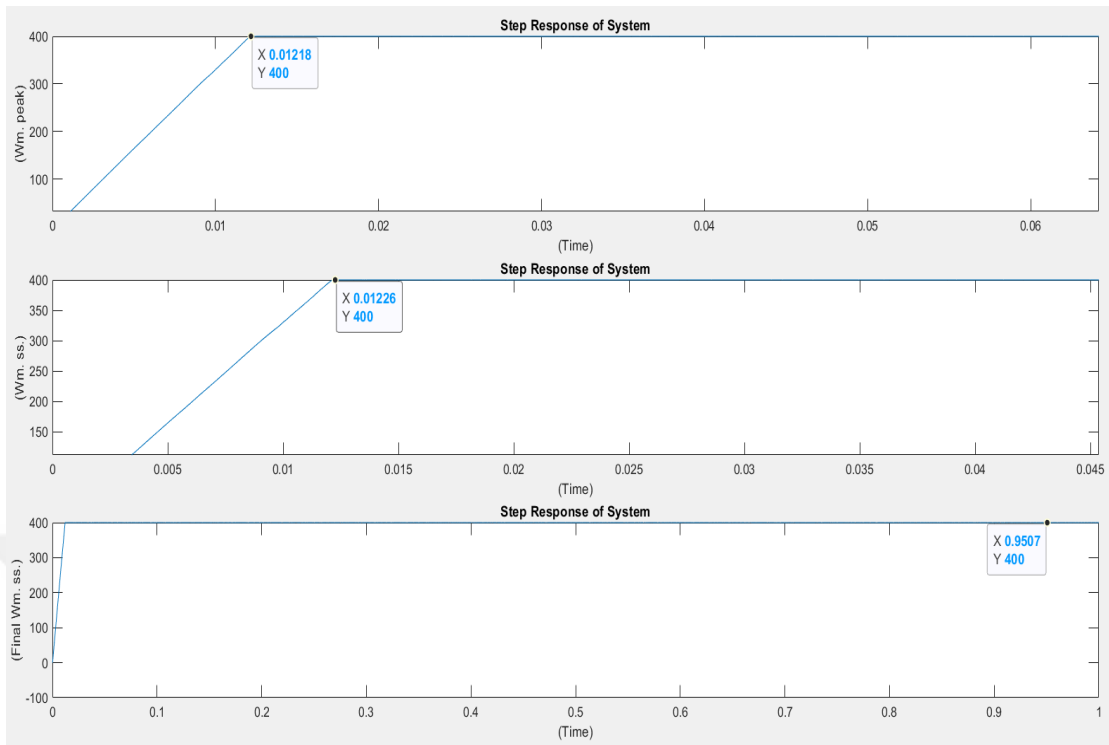

Figure 30: FLC (GA) (Multiple) 0-400 (Wm_peak(rad/sec): 400, tr (sec.): 0.012, Wm_ss(rad/sec): 400, ts (sec.): 0.012, Final Wm_ss(rad/sec): 400)

5.1.21. FLC[14] 200-400

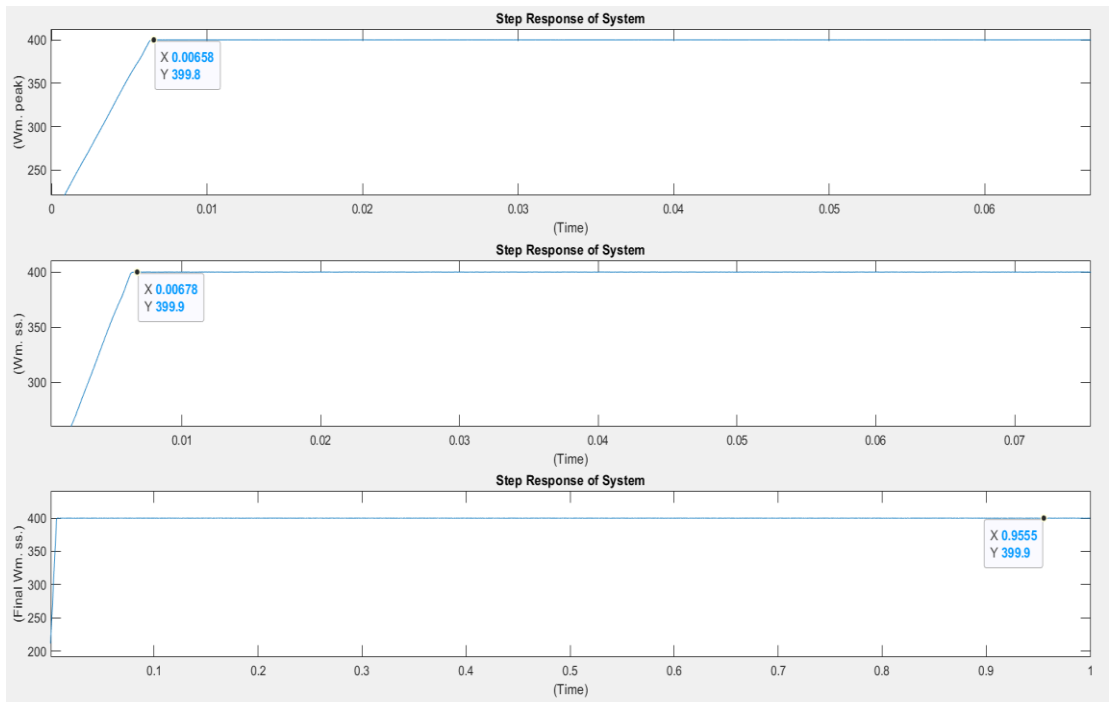

Figure 31: FLC[14] 200-400 (Wm_peak(rad/sec): 399.8, tr (sec.): 0.0065, Wm_ss(rad/sec): 399.9, ts (sec.): 0.0067, Final Wm_ss(rad/sec): 399.9)

5.1.22. PI(R.L)[14] 200-400

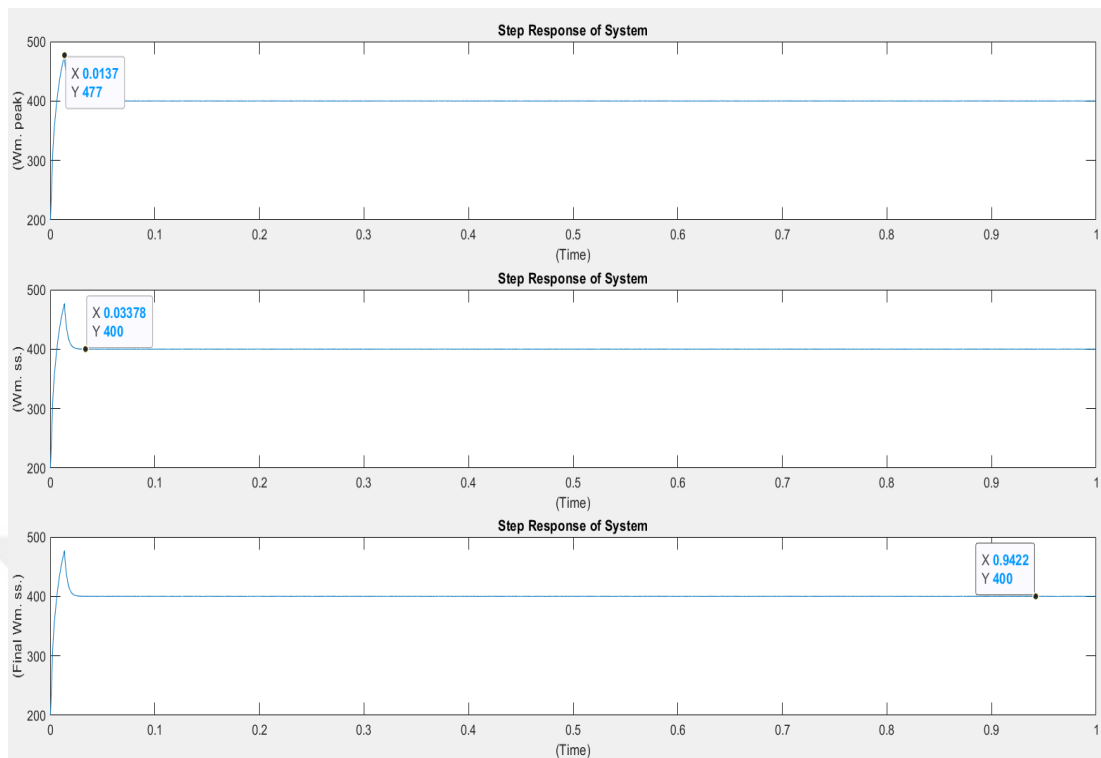

Figure 32: PI(R.L)[14] 200-400 (Wm_peak(rad/sec): 477, tr (sec.): 0.0137, Wm_ss(rad/sec): 400, ts (sec.): 0.033, Final Wm_ss(rad/sec): 400)

5.1.23. PI (GA)(Single) 200-400

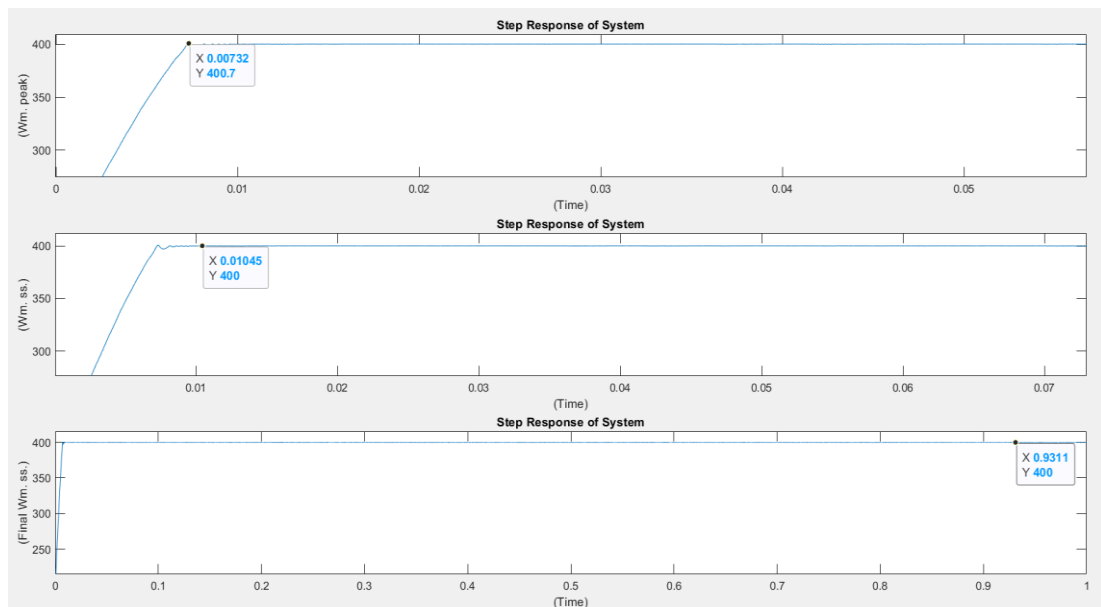

Figure 33: PI (GA)(Single) 200-400 (Wm_peak(rad/sec): 400.7, tr (sec.): 0.0073, Wm_ss(rad/sec): 400, ts (sec.): 0.0104, Final Wm_ss(rad/sec): 400)

5.1.24. PI (GA)(Multiple) 200-400

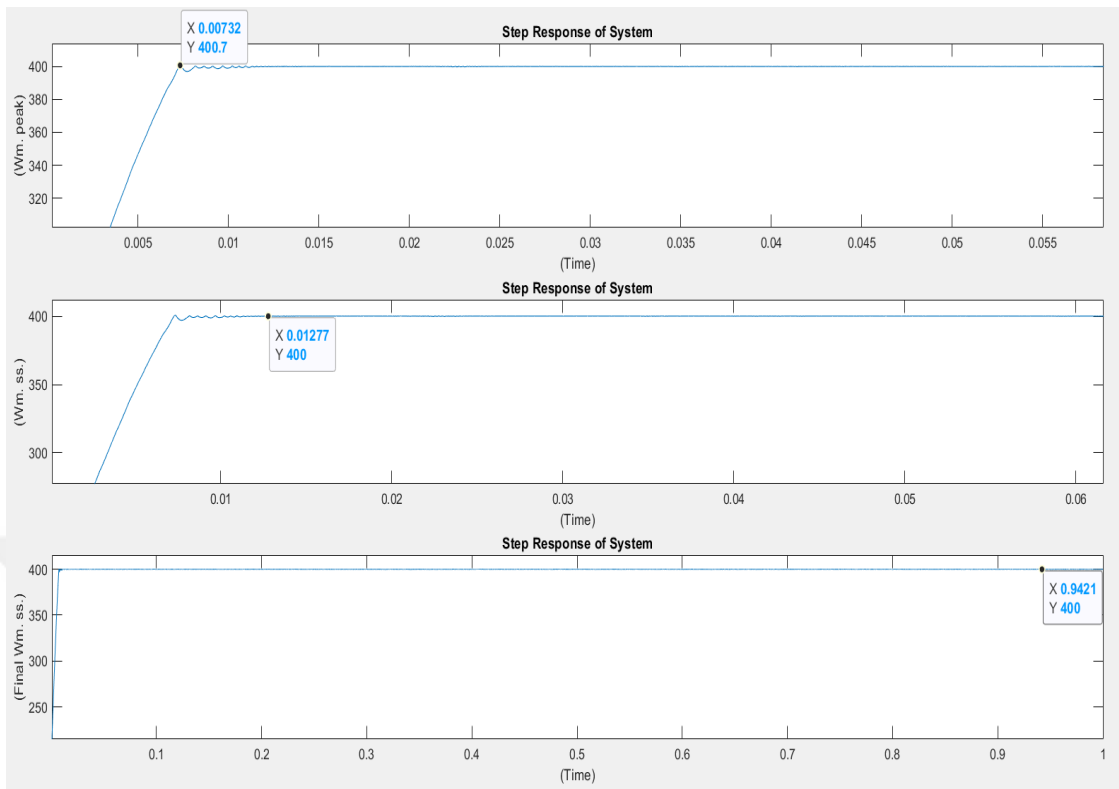

Figure 34: PI (GA)(Multiple) 200-400 (Wm_peak(rad/sec): 400.7, tr (sec.): 0.0073, Wm_ss(rad/sec): 400, ts (sec.): 0.0127, Final Wm_ss(rad/sec): 400)

5.1.25. FLC (GA)(Multiple) 200-400

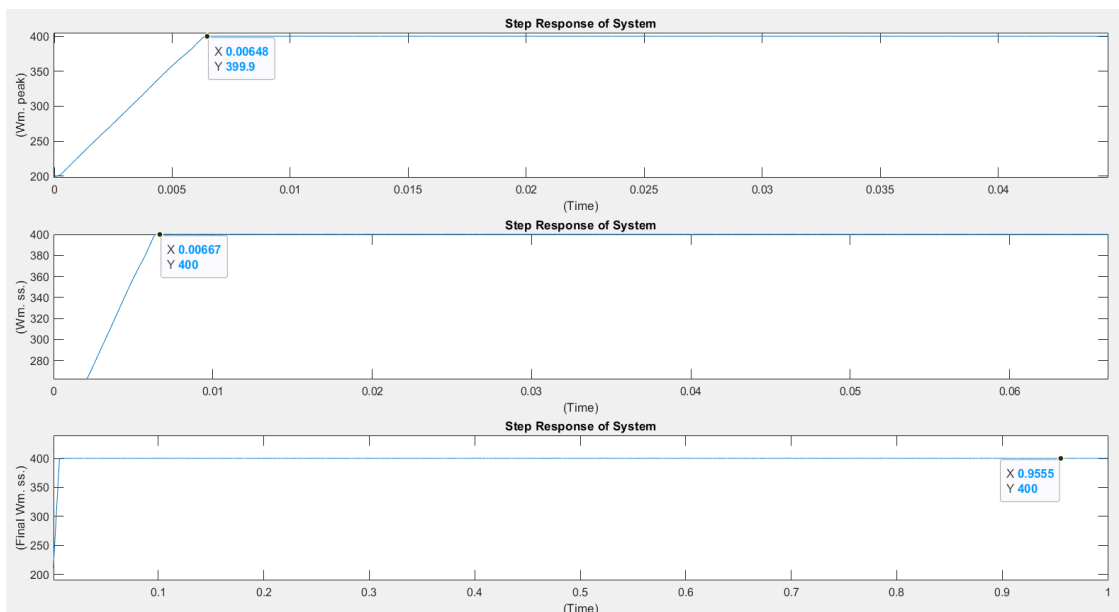

Figure 35: FLC (GA) (Multiple) 200-400 (Wm_peak(rad/sec): 399.9, tr (sec.): 0.0064, Wm_ss(rad/sec): 400, ts (sec.): 0.0066, Final Wm_ss(rad/sec): 400)

5.1.26. FLC[14] 380-400

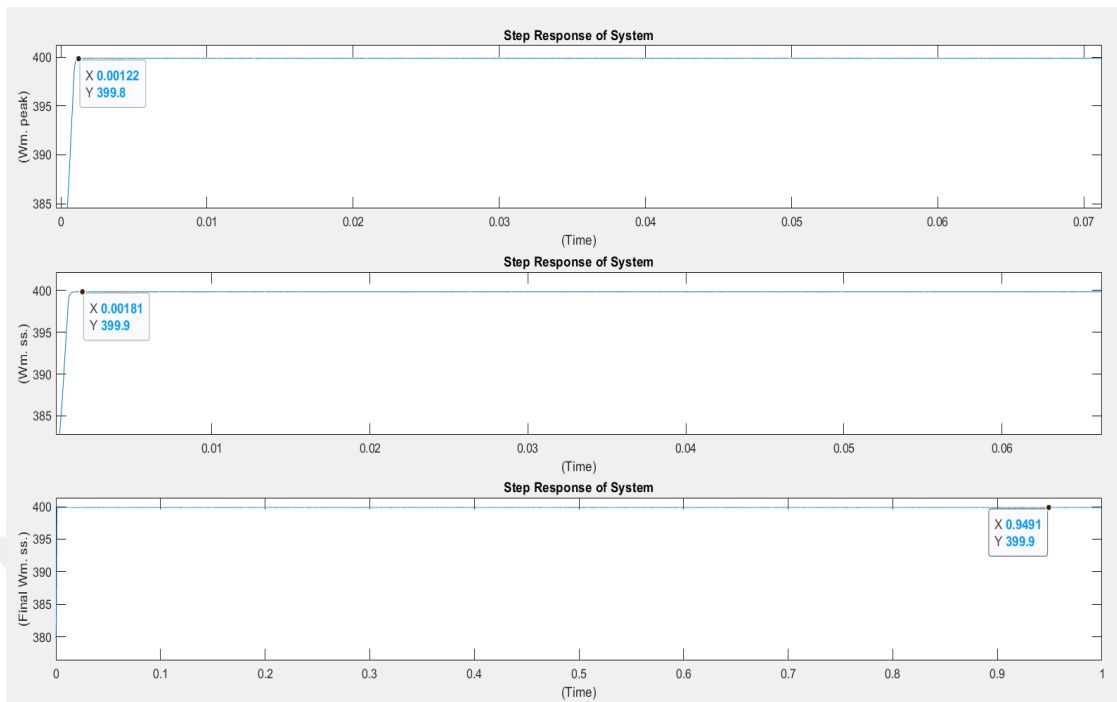

Figure 36: FLC[14] 380-400 (Wm_peak (rad/sec): 399.8, tr (sec.): 0.0012, Wm_ss (rad/sec): 399.9, ts (sec.): 0.0018, Final Wm_ss (rad/sec): 399.9)

5.1.27. PI(R.L)[14] 380-400

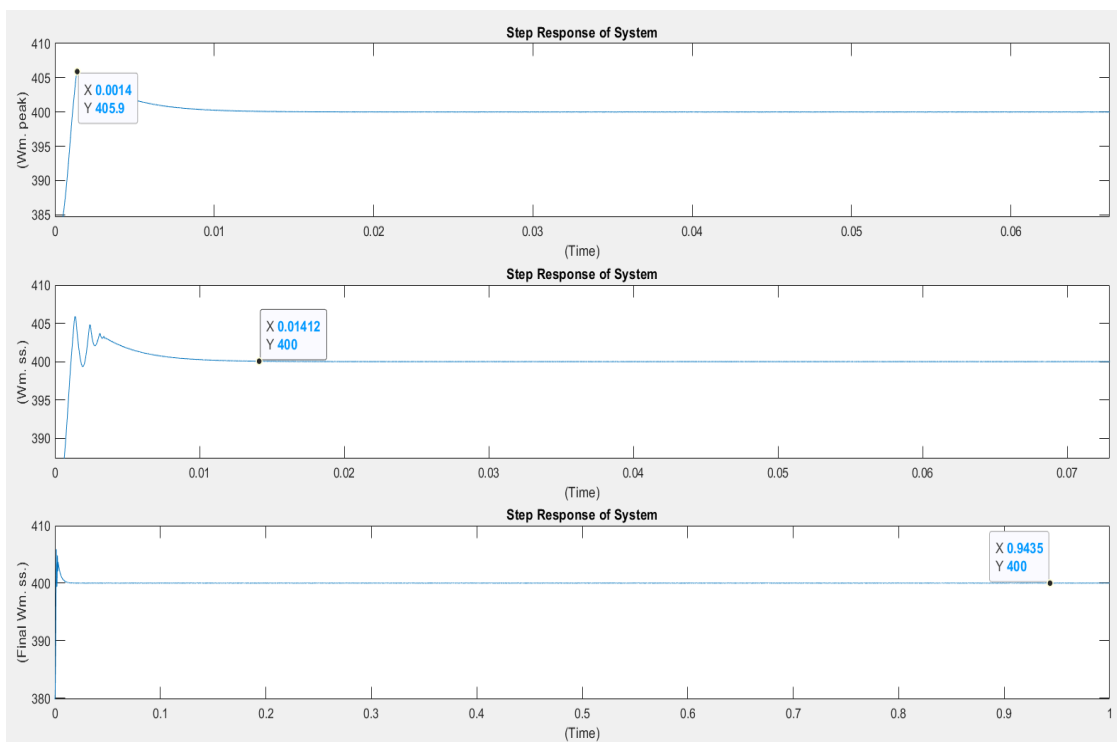

Figure 37: PI(R.L)[14] 380-400 (Wm_peak (rad/sec): 405.9, tr (sec.): 0.0014, Wm_ss (rad/sec): 400, ts (sec.): 0.014, Final Wm_ss (rad/sec): 400)

5.1.28. PI (GA)(Single) 380-400

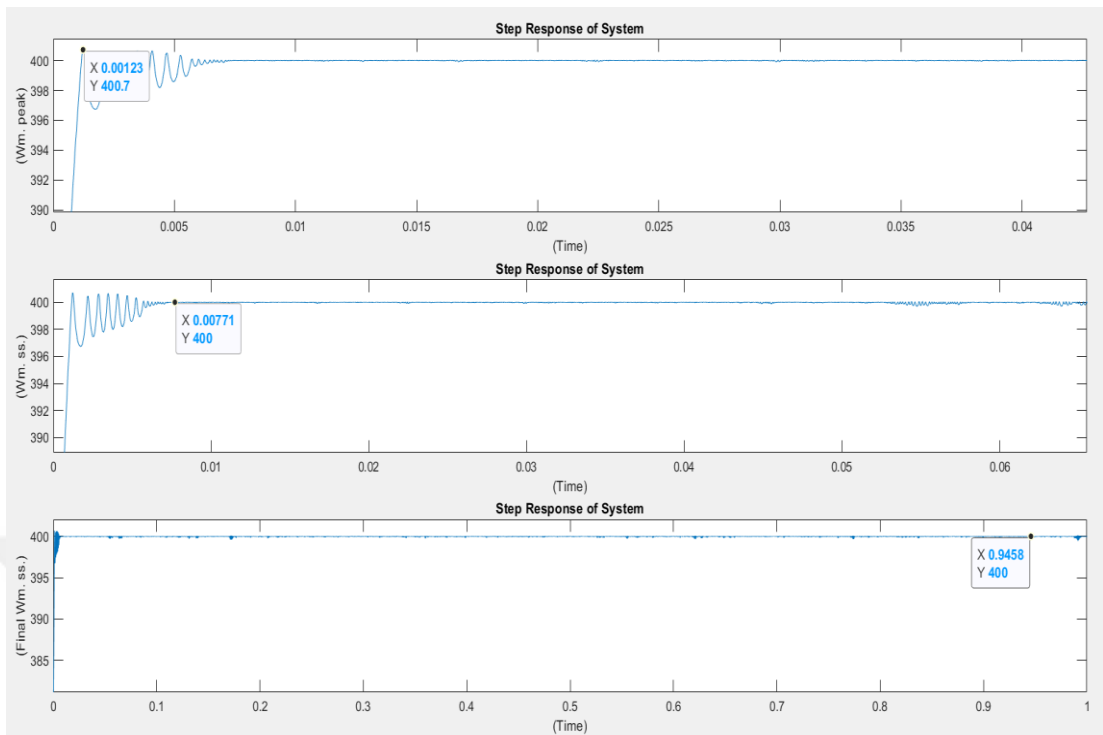

Figure 38: PI (GA)(Single) 380-400 (Wm_peak (rad/sec): 400.7, tr (sec.): 0.0012, Wm_ss (rad/sec): 400, ts (sec.): 0.0077, Final Wm_ss (rad/sec): 400)

5.1.29. PI (GA)(Multiple) 380-400

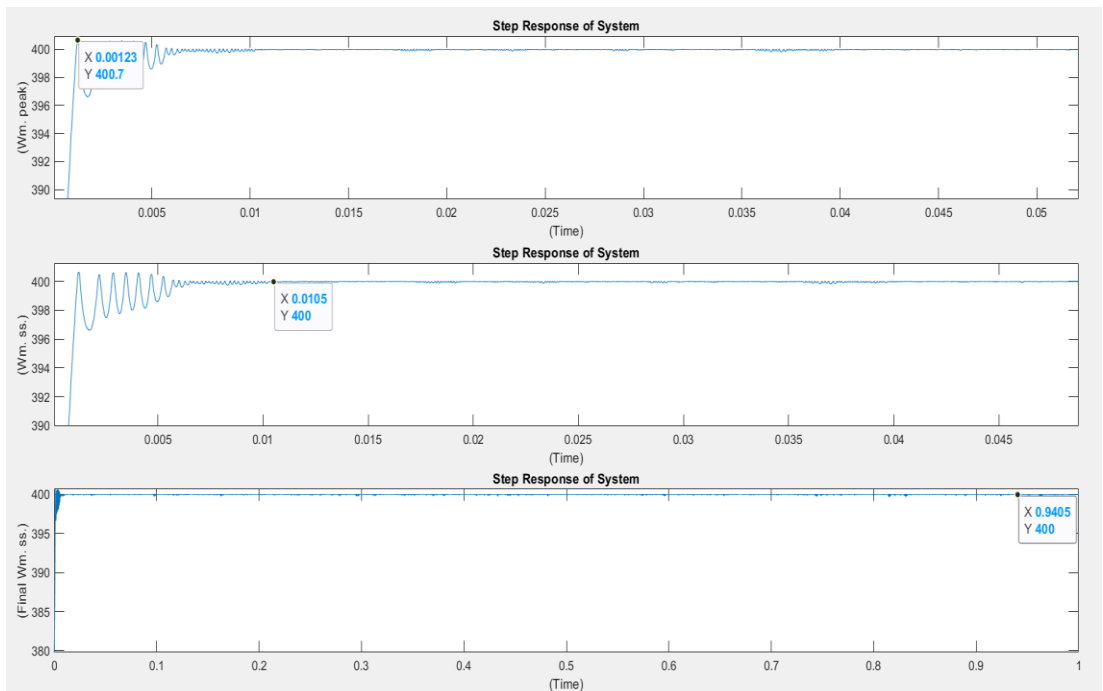

Figure 39: PI (GA)(Multiple) 380-400 (Wm_peak (rad/sec): 400.7, tr (sec.): 0.0012, Wm_ss (rad/sec): 400, ts (sec.): 0.0105, Final Wm_ss (rad/sec): 400)

5.1.30. FLC (GA)(Multiple) 380-400

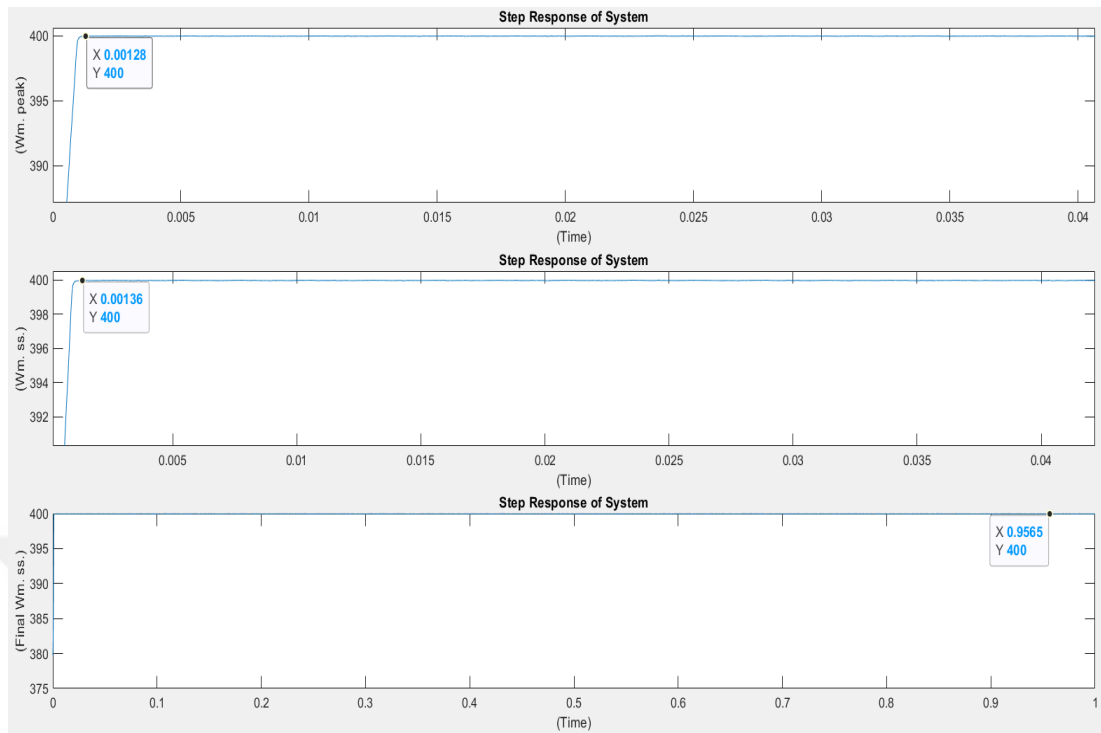

Figure 40: FLC (GA) (Multiple) 380-400 (Wm_peak(rad/sec): 400, tr (sec.): 0.0012, Wm_ss(rad/sec): 400, ts (sec.): 0.0013, Final Wm_ss(rad/sec): 400)

5.1.31. FLC[14] 300-350

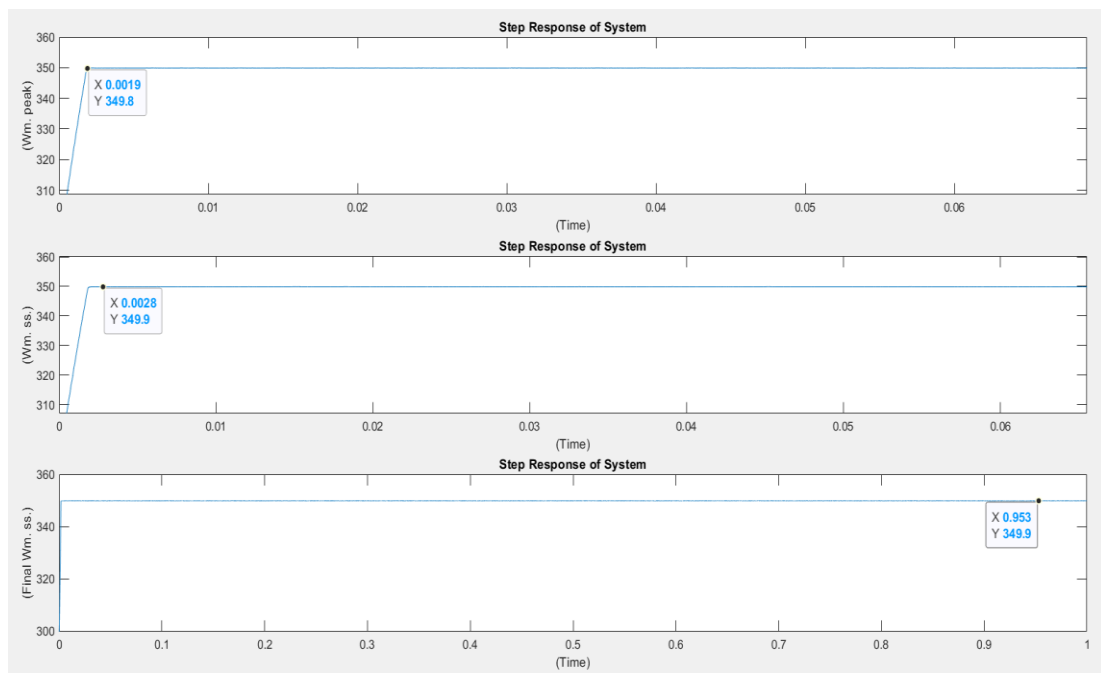

Figure 41: FLC[14] 300-350 (Wm_peak(rad/sec): 349.8, tr (sec.): 0.0019, Wm_ss(rad/sec): 349.9, ts (sec.): 0.0028, Final Wm_ss(rad/sec): 349.9)

5.1.32. PI(R.L)[14] 300-350

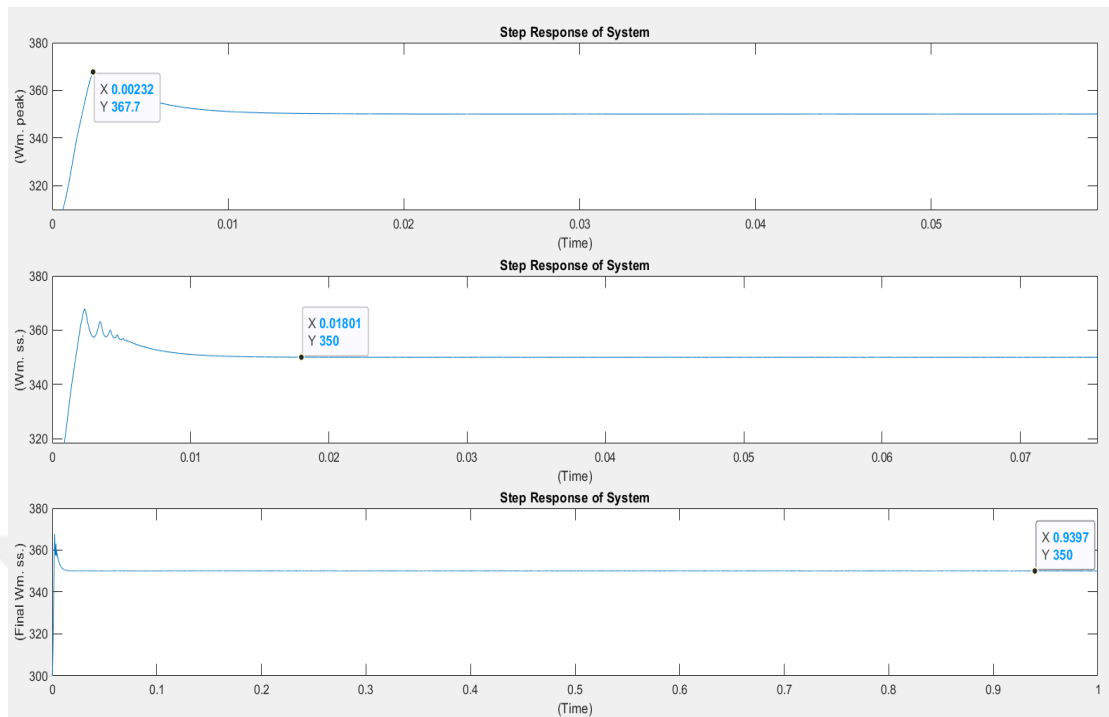

Figure 42: PI(R.L)[14] (Wm_peak(rad/sec): 367.7, tr (sec.): 0.0023, Wm_ss(rad/sec): 350, ts (sec.): 0.018, Final Wm_ss(rad/sec): 350)

5.1.33. PI (GA)(Single) 300-350

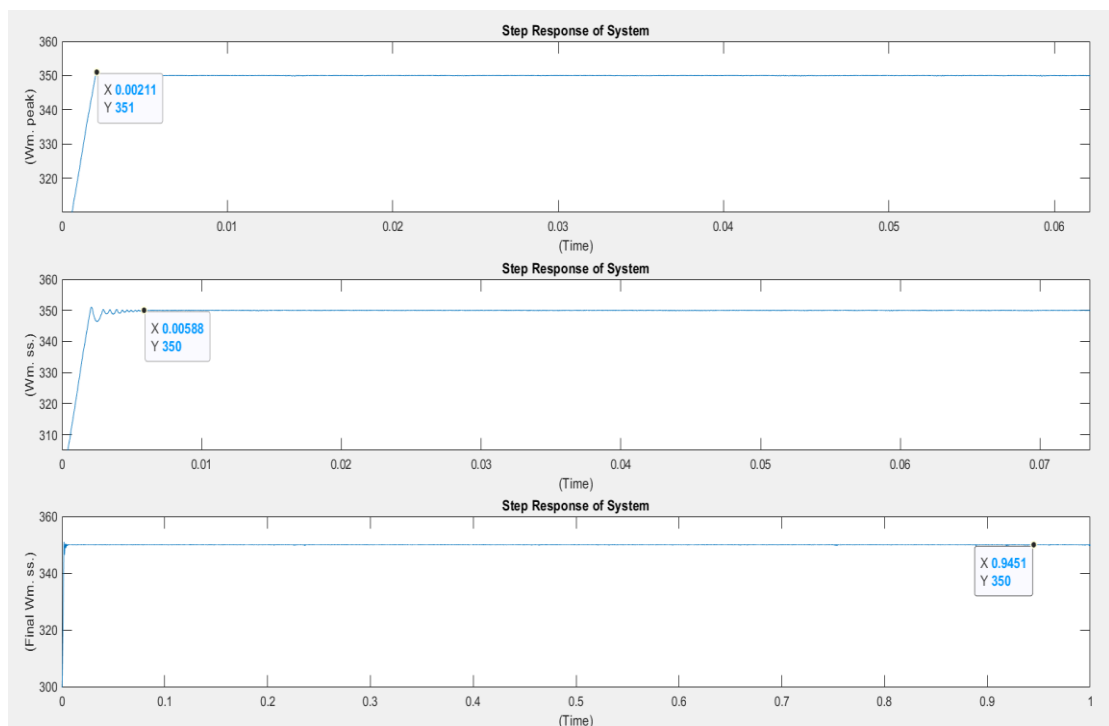

Figure 43: PI (GA)(Single) 300-350 (Wm_peak(rad/sec): 351, tr (sec.): 0.0021, Wm_ss(rad/sec): 350, ts (sec.): 0.0058, Final Wm_ss(rad/sec): 350)

5.1.34. PI (GA)(Multiple) 300-350

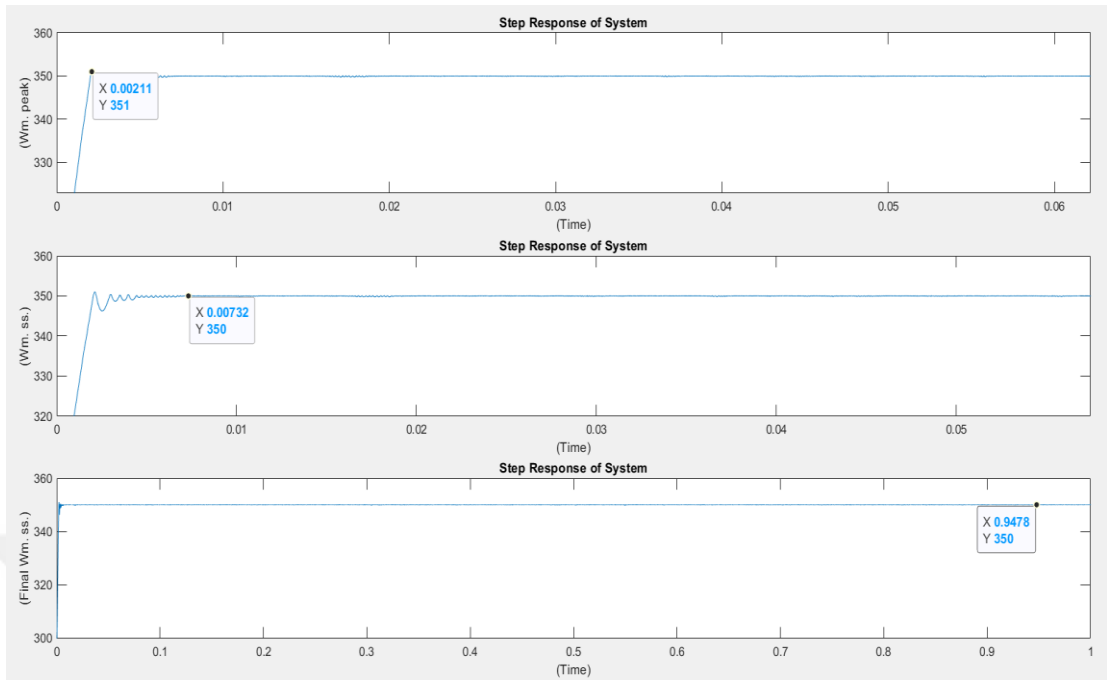

Figure 44: PI (GA)(Multiple) 300-350 (Wm_peak (rad/sec): 351, tr (sec.): 0.0021, Wm_ss (rad/sec): 350, ts (sec.): 0.0073, Final Wm_ss (rad/sec): 350)

5.1.35. FLC (GA)(Multiple) 300-350

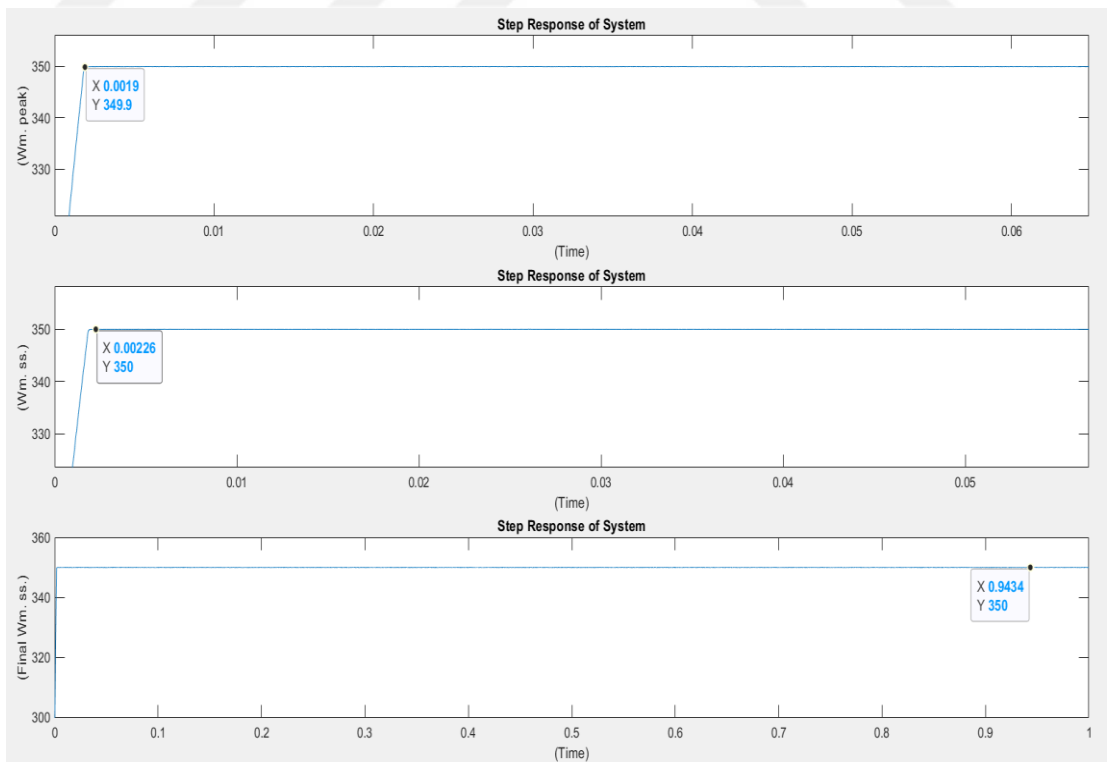

Figure 45: FLC (GA) (Multiple) 300-350 (Wm_peak (rad/sec): 349.9, tr (sec.): 0.0019, Wm_ss (rad/sec): 350, ts (sec.): 0.0022, Final Wm_ss (rad/sec): 350)

**CASE 1[(0)-(20)], [(20)-(40)], [(0)-(100)], [(0)-(400)], [(200)-(400)],
[(380)-(400)], [(300)-(350)]**

Table 8: Optimization Phase (Case 1) Motor Ranges Results

0-20 (rad/sec)	FLC[14]	PI(R.L)[14]	PI(GA) (Single)	PI(GA) (Multiple)	FLC(GA) (Multiple)
Wm_peak(rad/sec), Max. Os%	20.55, 2.75%	32.66, 57.2%	22.34, 11.7%	22.34, 11.7%	21.1, 5.5%
tr (sec.)	0.0008	0.0009	0.0009	0.0009	0.0008
Wm_ss(rad/sec)	19.9	20	20	20	20
ts (sec.)	0.0018	0.017	0.0048	0.0092	0.0011
Final Wm_ss(rad/sec), Max. Os%	19.88, 0.6%	20, 0%	20, 0%	20, 0%	19.99, 0.05%

0-20 FLC[14], PI(R.L)[14], PI(GA)(Single), PI(GA)(Multiple), FLC(GA)(Multiple)

20-40 (rad/sec)	FLC[14]	PI(R.L)[14]	PI(GA) (Single)	PI(GA) (Multiple)	FLC(GA) (Multiple)
Wm_peak(rad/sec), Max. Os%	40.26, 0.65%	52.78, 21.11%	42.43, 6.07%	42.43, 6.07%	40.79, 1.97%
tr (sec.)	0.0008	0.0009	0.0009	0.0009	0.0008
Wm_ss(rad/sec)	39.89	40	40	40	40
ts (sec.)	0.0021	0.017	0.0061	0.0076	0.0011
Final Wm_ss(rad/sec), Max. Os%	39.88, 0.29%	40, 0%	40, 0%	40, 0%	39.99, 0.025%

20-40 FLC[14], PI(R.L)[14], PI(GA)(Single), PI(GA)(Multiple), FLC(GA)(Multiple)

0-100 (rad/sec)	FLC[14]	PI(R.L)[14]	PI(GA) (Single)	PI(GA) (Multiple)	FLC(GA) (Multiple)
Wm_peak(rad/sec), Max. Os%	100.4, 0.4%	153.7, 53.7%	102.4, 2.4%	102.4, 2.4%	101, 1%
tr (sec.)	0.0031	0.0021	0.0032	0.0032	0.0032
Wm_ss(rad/sec)	99.89	100	100	100	100
ts (sec.)	0.0035	0.019	0.0086	0.0094	0.0034
Final Wm_ss(rad/sec), Max. Os%	99.87, 0.13%	100, 0%	100, 0%	100, 0%	99.99, 0.01%

0-100 FLC[14], PI(R.L)[14], PI(GA)(Single), PI(GA)(Multiple), FLC(GA)(Multiple)

0-400 (rad/sec)	FLC[14]	PI(R.L)[14]	PI(GA) (Single)	PI(GA) (Multiple)	FLC(GA) (Multiple)
Wm_peak(rad/sec), Max. Os%	399.4, 0.15%	510.1, 27.52%	400.7, 0.175%	400.7, 0.175%	400, 0%
tr (sec.)	0.012	0.021	0.013	0.013	0.012
Wm_ss(rad/sec)	399.9	400	400	400	400
ts (sec.)	0.013	0.042	0.020	0.020	0.012
Final Wm_ss(rad/sec), Max. Os%	399.9, 0.025%	400, 0%	400, 0%	400.1, 0.025%	400, 0%

0-400 FLC[14], PI(R.L)[14], PI(GA)(Single), PI(GA)(Multiple), FLC(GA)(Multiple)

200-400 (rad/sec)	FLC[14]	PI(R.L)[14]	PI(GA) (Single)	PI(GA) (Multiple)	FLC(GA) (Multiple)
Wm_peak(rad/sec), Max. Os%	399.8, 0.05%	477, 19.25%	400.7, 0.17%	400.7, 0.17%	399.9, 0.025%
tr (sec.)	0.0065	0.0137	0.0073	0.0073	0.0064
Wm_ss(rad/sec)	399.9	400	400	400	400
ts (sec.)	0.0067	0.033	0.0104	0.0127	0.0066
Final Wm_ss(rad/sec), Max. Os%	399.9, 0.025%	400, 0%	400, 0%	400, 0%	400, 0%

200-400 FLC[14], PI(R.L)[14], PI(GA)(Single), PI(GA)(Multiple), FLC(GA)(Multiple)

380-400 (rad/sec)	FLC[14]	PI(R.L)[14]	PI(GA) (Single)	PI(GA) (Multiple)	FLC(GA) (Multiple)
Wm_peak(rad/sec), Max. Os%	399.8, 0.05%	405.9, 1.47%	400.7, 0.17%	400.7, 0.17%	400, 0%
tr (sec.)	0.0012	0.0014	0.0012	0.0012	0.0012
Wm_ss(rad/sec)	399.9	400	400	400	400
ts (sec.)	0.0018	0.014	0.0077	0.0105	0.0013
Final Wm_ss(rad/sec), Max. Os%	399.9, 0.025%	400, 0%	400, 0%	400, 0%	400, 0%

380-400 FLC[14], PI(R.L)[14], PI(GA)(Single), PI(GA)(Multiple), FLC(GA)(Multiple)

300-350 (rad/sec)	FLC[14]	PI(R.L)[14]	PI(GA) (Single)	PI(GA) (Multiple)	FLC(GA) (Multiple)
Wm_peak(rad/sec), Max. Os%	349.8, 0.05%	367.7, 5.05%	351, 0.28%	351, 0.28%	349.9, 0.028%
tr (sec.)	0.0019	0.0023	0.0021	0.0021	0.0019
Wm_ss(rad/sec)	349.9	350	350	350	350
ts (sec.)	0.0028	0.018	0.0058	0.0073	0.0022
Final Wm_ss(rad/sec), Max. Os%	349.9, 0.028%	350, 0%	350, 0%	350, 0%	350, 0%

300-350 FLC[14], PI(R.L)[14], PI(GA)(Single), PI(GA)(Multiple), FLC(GA)(Multiple)

5.1.36. OPTIMIZATION PHASE (CASE 1) RESULTS

In all the simulations in this chapter, the initial angular speeds and reference angular speeds of the BLDC are taken as in Table 3. For all simulations the load torque is taken as 0.5 Nm. and applied DC voltage is taken as $V_{DC} = 68$ Volt. These values are same as the ones applied in [14].

It is observed that that PI (R.L)[14] has the biggest percentage overshoot value and slowest settling time. But the good side is of this controller is, the angular speed finishes the simulation very close to reference angular speed value and hence it has a good (very small) steady-state error.

FLC[14] controller has very small percentage overshoot value and its performance criteria are generally satisfactory. But biggest disadvantage of FLC[14] is, it never reaches the reference angular speed value during simulation time. It has always a small steady-state error value.

The controller that are obtained by Single PI and Multiple PI Approach have better percentage overshoot and rise time values compared to the PI (R.L)[14] controller, and its performance is very close to FLC[14]. The advantage of these controller's, they have the minimum steady-state error values in all speed ranges.

When Single PI Approach and Multiple PI approach are compared with each other, It is observed that their results are generally indifferent but outputs of PI Multiple approach has slightly higher settling time.

The Multiple FLC Approach presents the best rise time and settling time values with almost minimal steady-state error values. We can say Multiple FLC outperforms other controller nearly in all speed ranges.

5.2. CASE 2 [(40)-(20)], [(-20)-(-40)], [(0)-(-400)], [(400)-(380)], [(-380)-(-400)]

5.2.1. FLC[14] 40-20

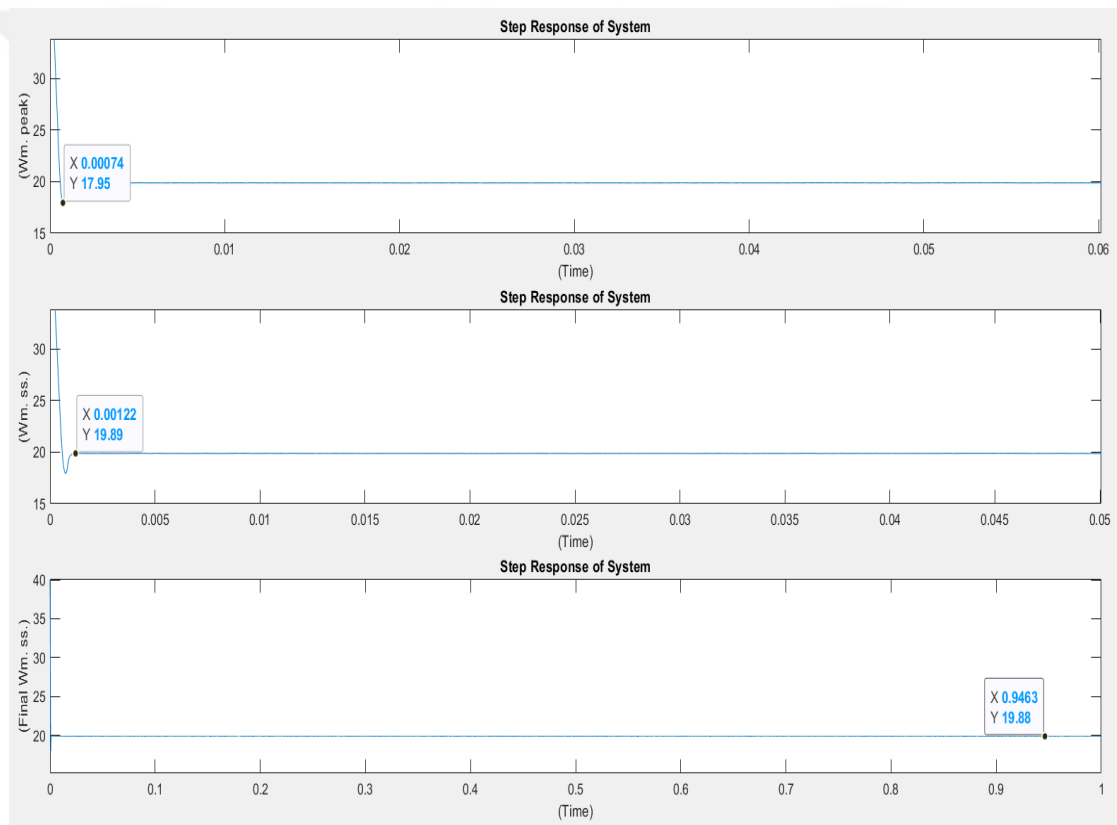

Figure 46: FLC[14] 40-20 (Wm_{peak} (rad/sec): 17.95, tr (sec.): 0.00074, Wm_{ss} (rad/sec): 19.89, ts (sec.): 0.00122, Final Wm_{ss} (rad/sec): 19.88)

5.2.2. PI(R.L)[14] 40-20

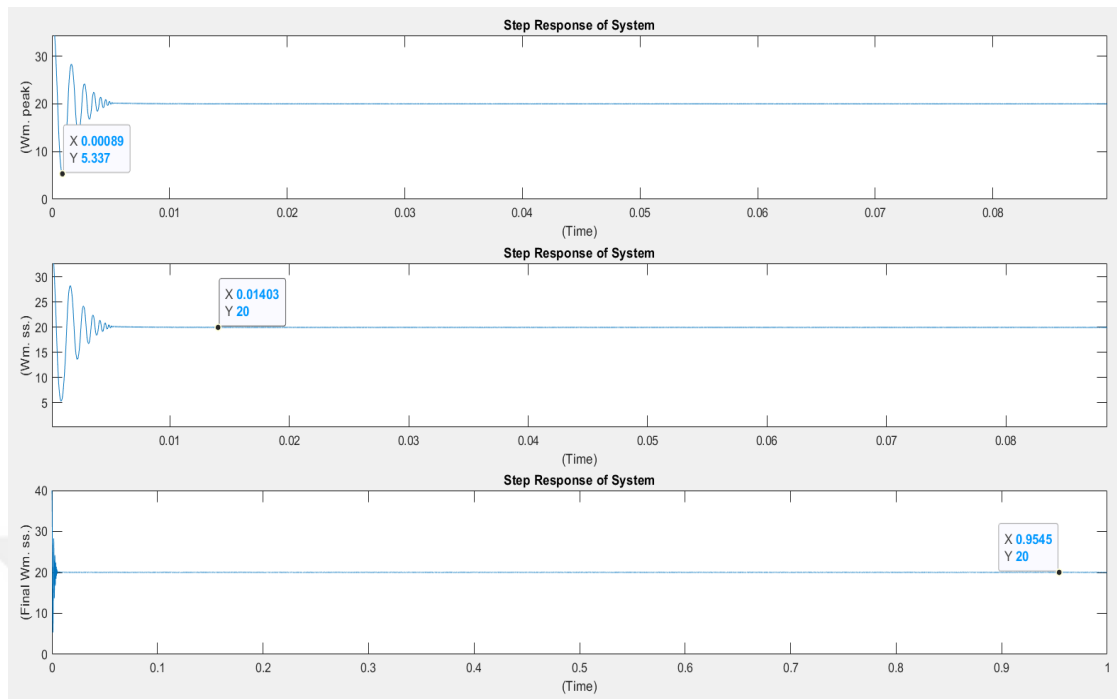

Figure 47: PI(R.L)[14] 40-20 (Wm_peak(rad/sec): 5.33, tr (sec.): 0.00089, Wm_ss(rad/sec): 20, ts (sec.): 0.014, Final Wm_ss(rad/sec): 20)

5.2.3. PI (GA)(Single) 40-20

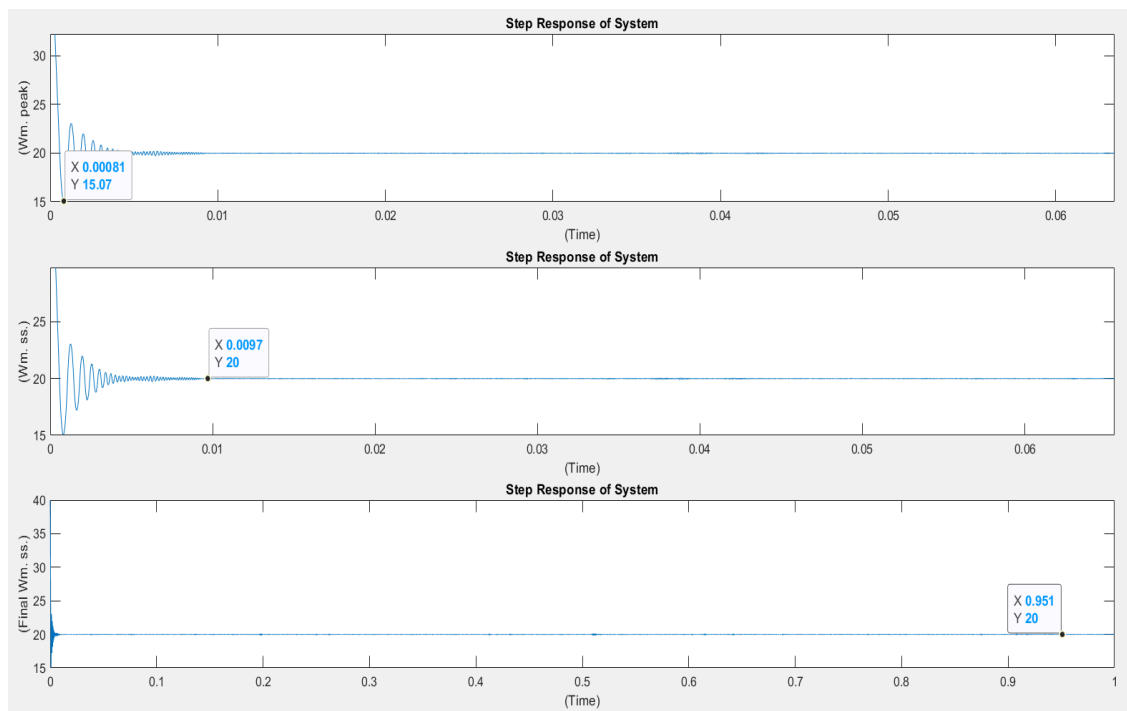

Figure 48: PI (GA)(Single) 40-20 (Wm_peak(rad/sec): 15.07, tr (sec.): 0.00081, Wm_ss(rad/sec): 20, ts (sec.): 0.0097, Final Wm_ss(rad/sec): 20)

5.2.4. PI (GA)(Multiple) 40-20

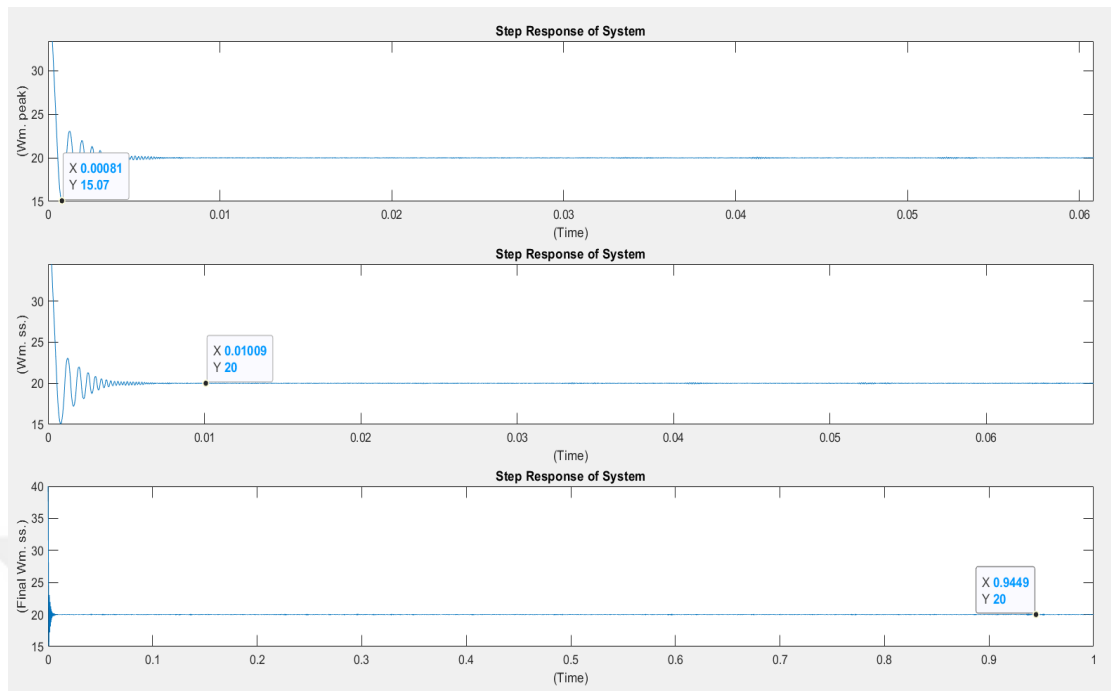

Figure 49: PI (GA)(Multiple) 40-20 (Wm_peak(rad/sec): 15.07, tr (sec.): 0.00081, Wm_ss(rad/sec): 20, ts (sec.): 0.0100, Final Wm_ss(rad/sec): 20)

5.2.5. FLC (GA)(Multiple) 40-20

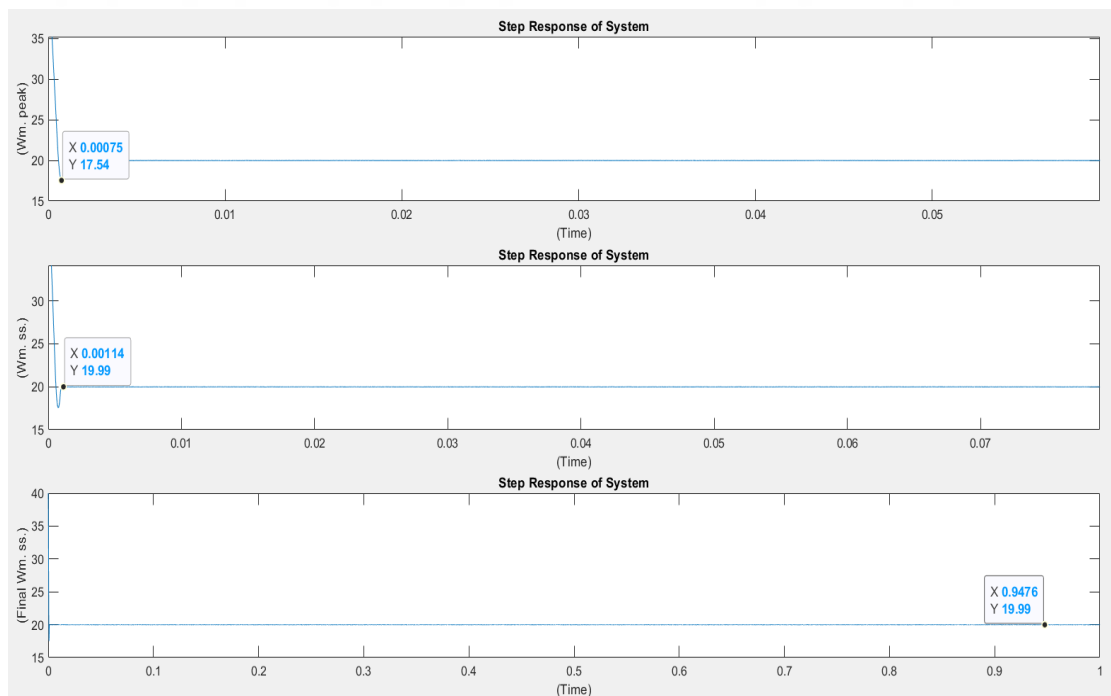

Figure 50: FLC (GA) (Multiple) 40-20 (Wm_peak(rad/sec): 17.54, tr (sec.): 0.00075, Wm_ss(rad/sec): 19.99, ts (sec.): 0.00114, Final Wm_ss(rad/sec): 19.99)

5.2.6. FLC[14] (-20)-(-40)

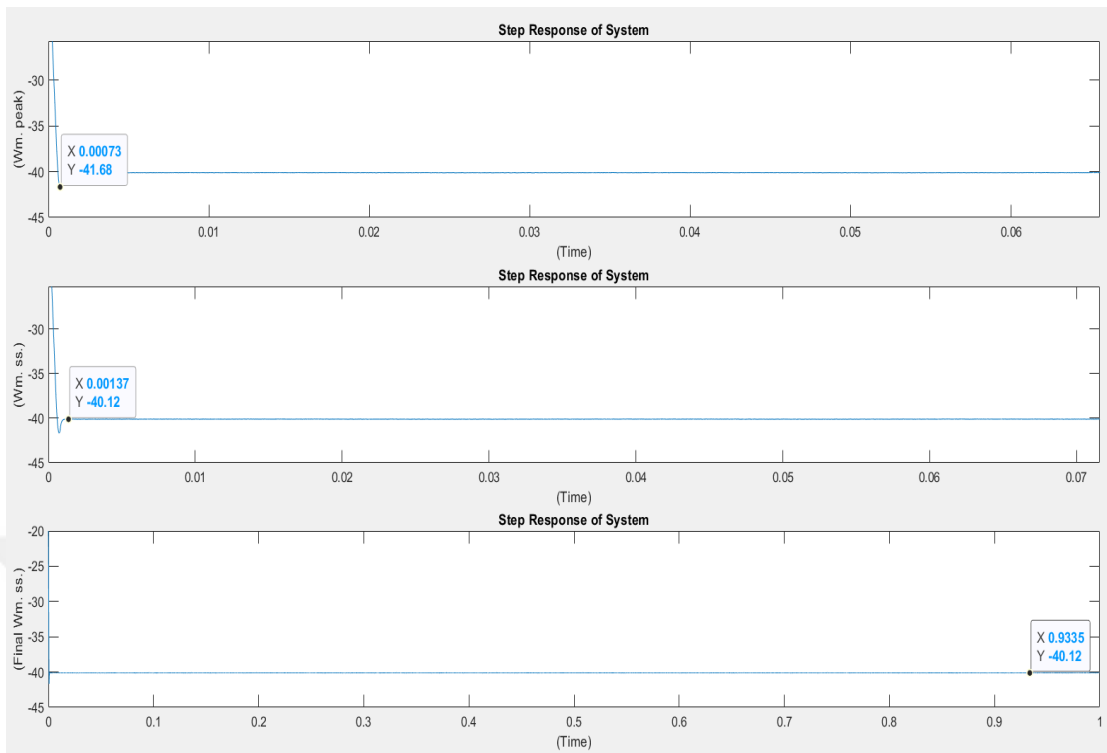

Figure 51: FLC[14] (-20)-(-40) (Wm_{peak}(rad/sec): -41.68, tr (sec.): 0.00073, Wm_{ss}(rad/sec): -40.12, ts (sec.): 0.00137, Final Wm_{ss}(rad/sec): -40.12)

5.2.7. PI(R.L)[14] (-20)-(-40)

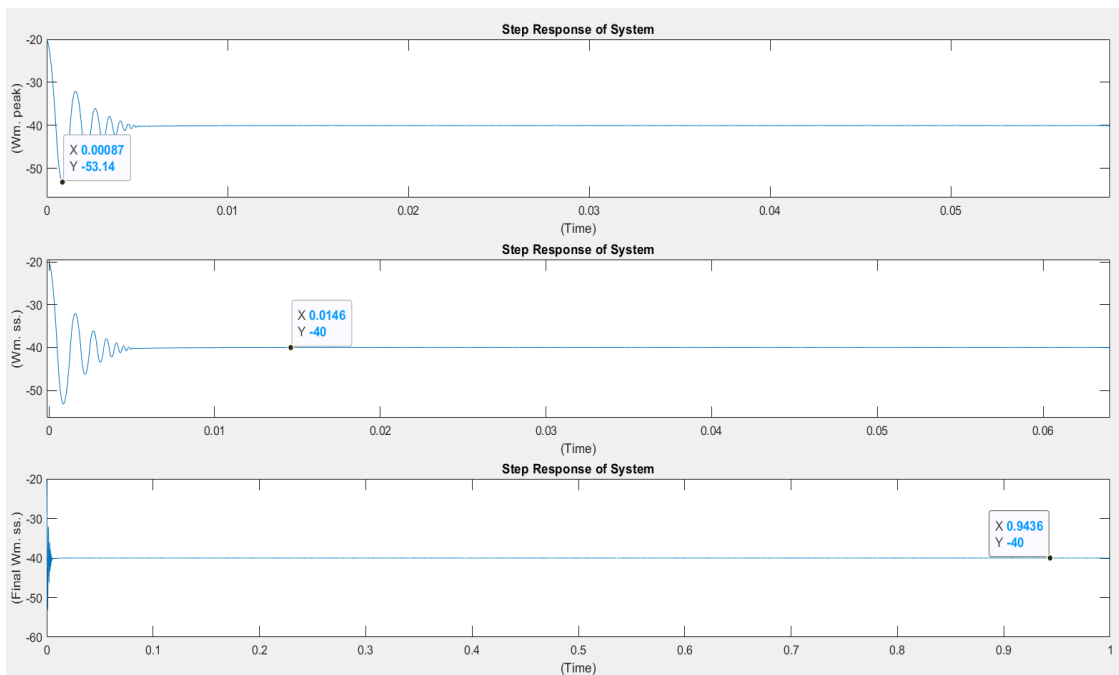

Figure 52: PI(R.L)[14] (-20)-(-40) (Wm_{peak}(rad/sec): -53.14, tr (sec.): 0.00087, Wm_{ss}(rad/sec): -40, ts (sec.): 0.0146, Final Wm_{ss}(rad/sec): -40)

5.2.8. PI (GA)(Single) (-20)-(-40)

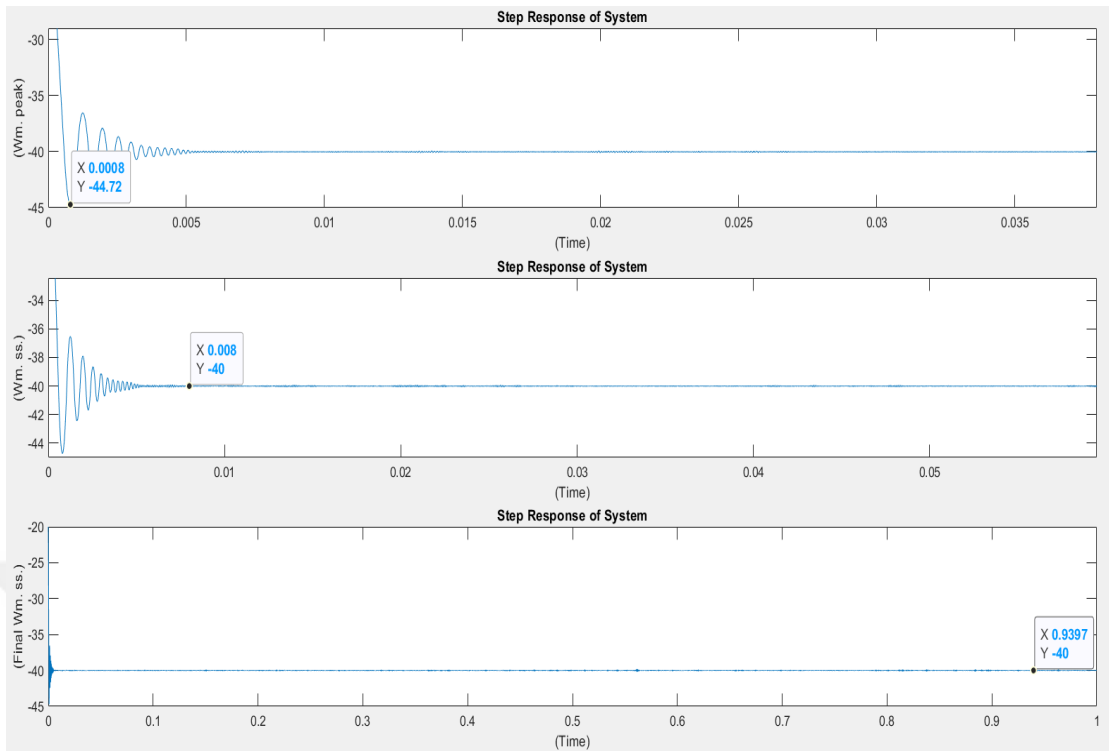

Figure 53: PI (GA)(Single) (-20)-(-40) (Wm_peak(rad/sec): -44.72, tr (sec.): 0.0008, Wm_ss(rad/sec): -40, ts (sec.): 0.0080, Final Wm_ss(rad/sec): -40)

5.2.9. PI (GA)(Multiple) (-20)-(-40)

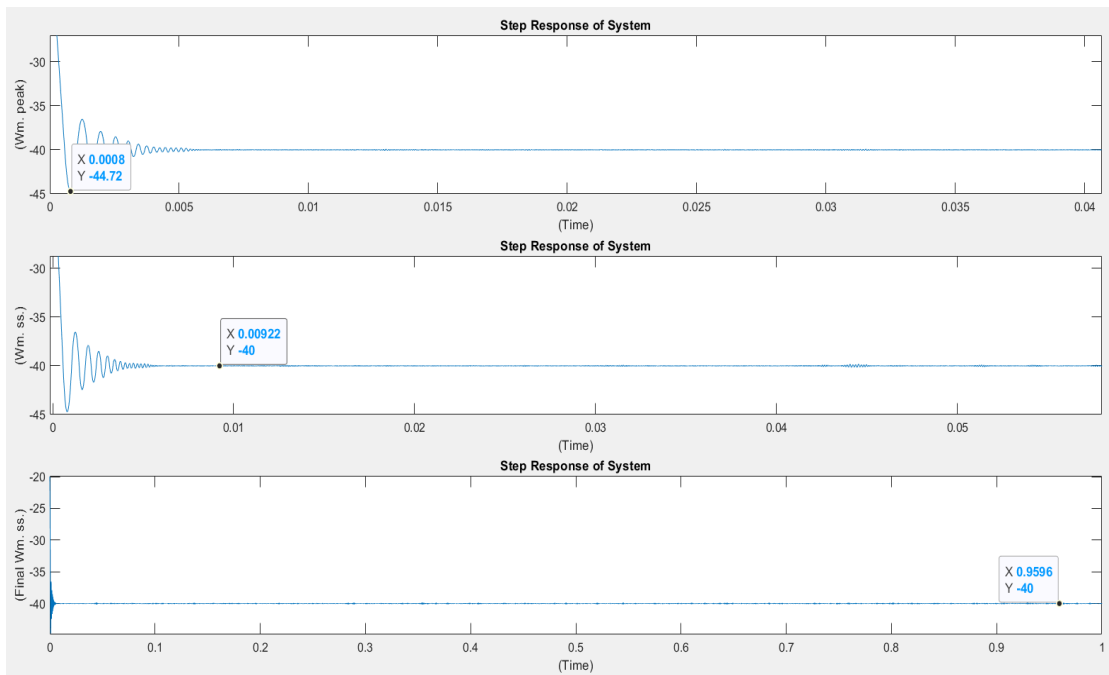

Figure 54: PI (GA)(Multiple) (-20)-(-40) (Wm_peak(rad/sec): -44.72, tr (sec.): 0.0008, Wm_ss(rad/sec): -40, ts (sec.): 0.0092, Final Wm_ss(rad/sec): -40)

5.2.10. FLC (GA)(Multiple) (-20)-(-40)

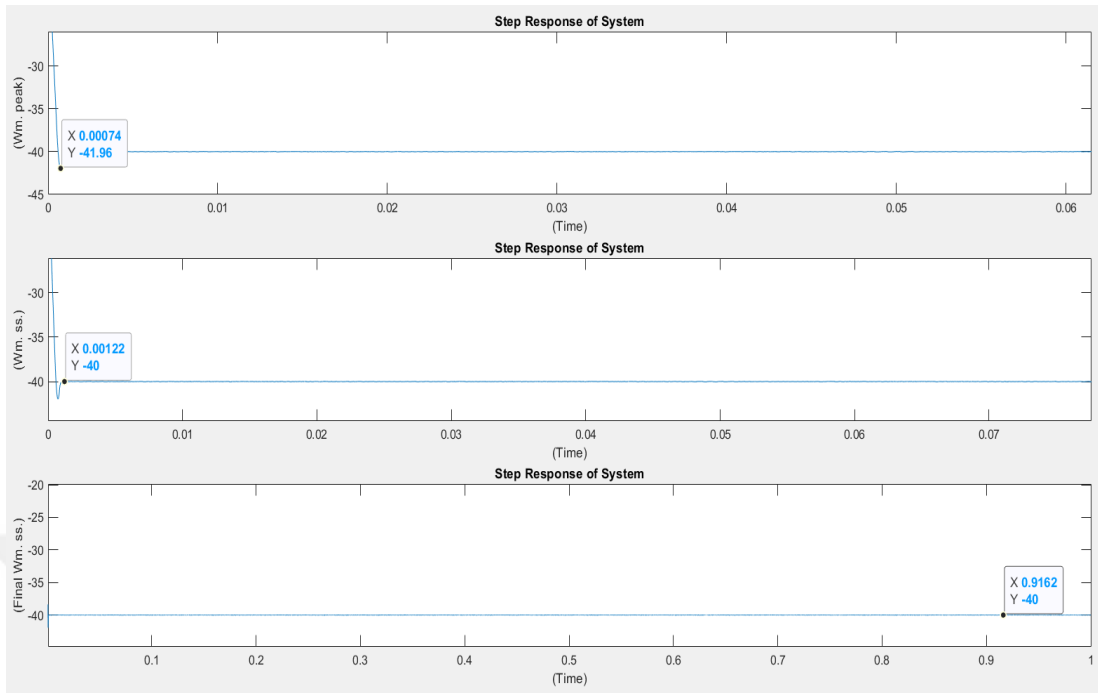

Figure 55: FLC (GA) (Multiple) (-20)-(-40) (Wm_peak(rad/sec): -41.96, tr (sec.): 0.00074, Wm_ss(rad/sec): -40, ts (sec.): 0.00122, Final Wm_ss(rad/sec): -40)

5.2.11. FLC[14] (0)-(-400)

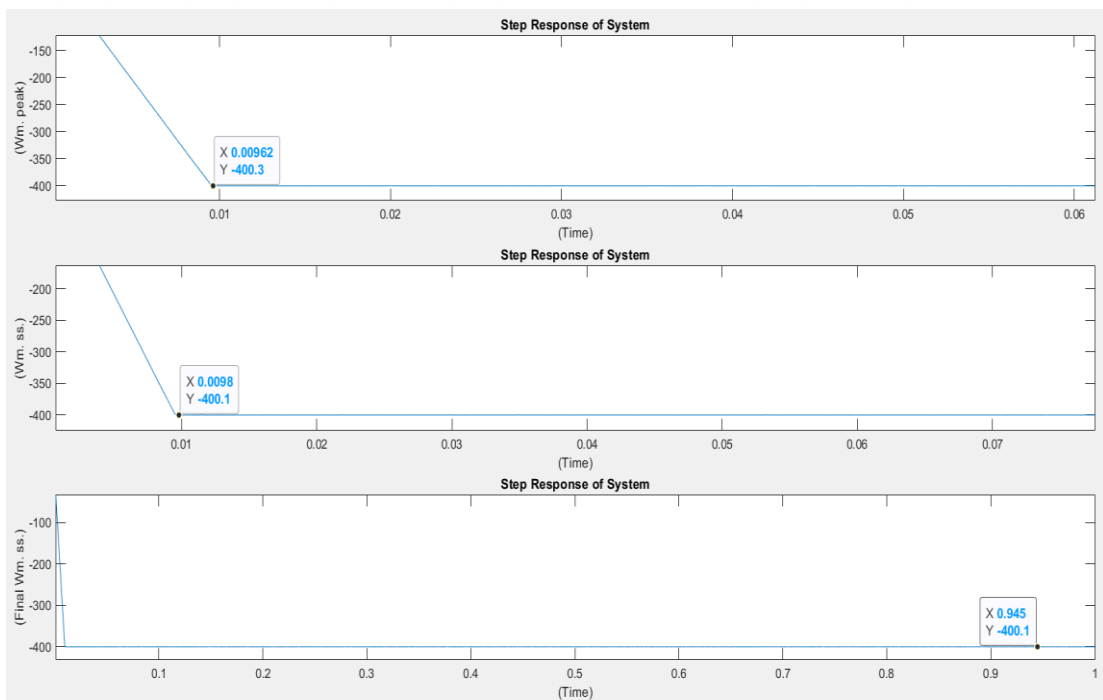

Figure 56: FLC[14] (0)-(-400) (Wm_peak(rad/sec): -400.3, tr (sec.): 0.00962, Wm_ss(rad/sec): -400.1, ts (sec.): 0.0098, Final Wm_ss(rad/sec): -400.1)

5.2.12. PI(R.L)[14] (0)-(-400)

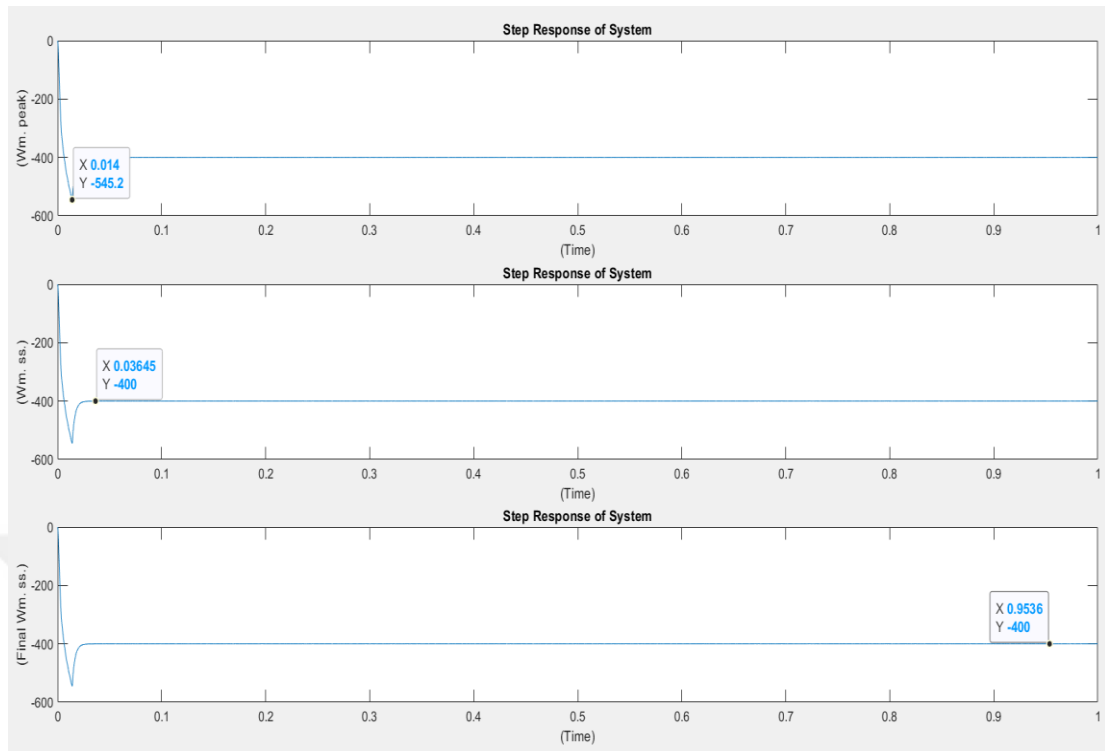

Figure 57: PI(R.L)[14] (0)-(-400) (Wm_peak(rad/sec): -545.2, tr (sec.): 0.0140, Wm_ss(rad/sec): -400, ts (sec.): 0.036, Final Wm_ss(rad/sec): -400)

5.2.13. PI (GA)(Single) (0)-(-400)

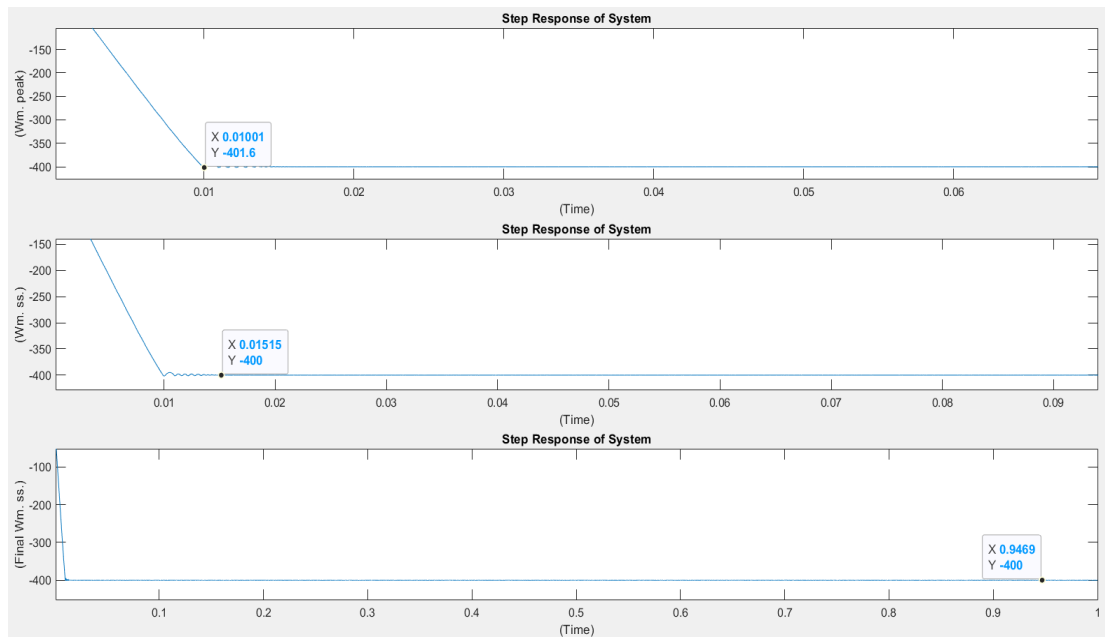

Figure 58: PI (GA)(Single) (0)-(-400) (Wm_peak(rad/sec): -401.6, tr (sec.): 0.0100, Wm_ss(rad/sec): -400, ts (sec.): 0.0151, Final Wm_ss(rad/sec): -400)

5.2.14. PI (GA)(Multiple) (0)-(-400)

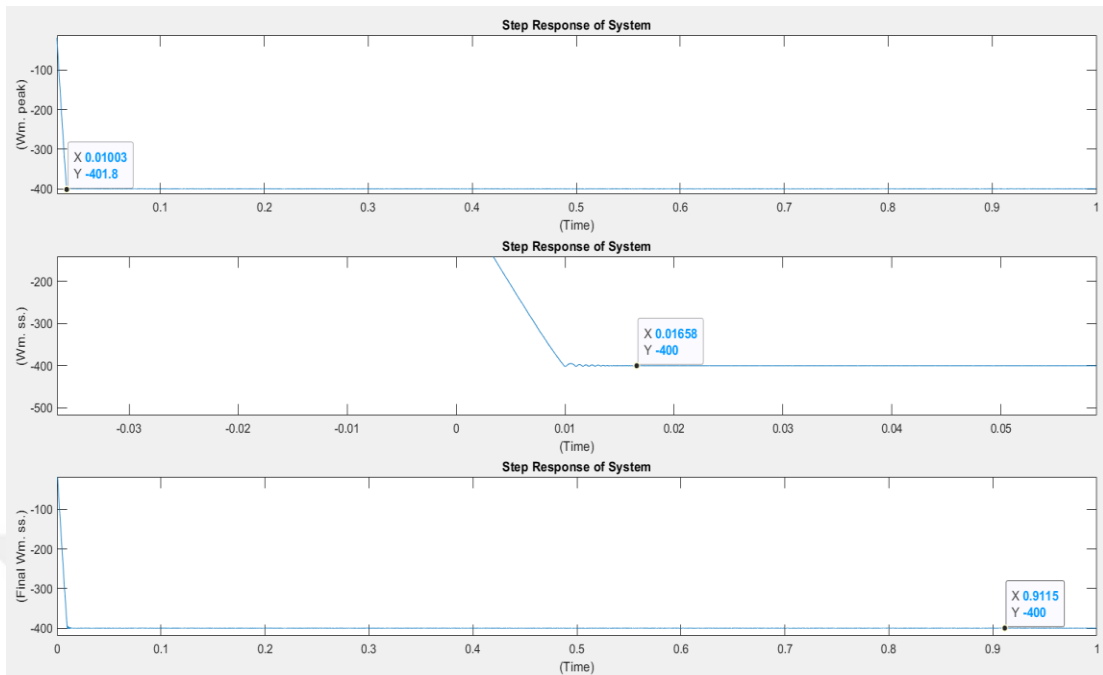

Figure 59: PI (GA)(Multiple) (0)-(-400) (Wm_peak(rad/sec): -401.8, tr (sec.): 0.0100, Wm_ss(rad/sec): -400, ts (sec.): 0.0165, Final Wm_ss(rad/sec): -400)

5.2.15. FLC (GA)(Multiple) (0)-(-400)

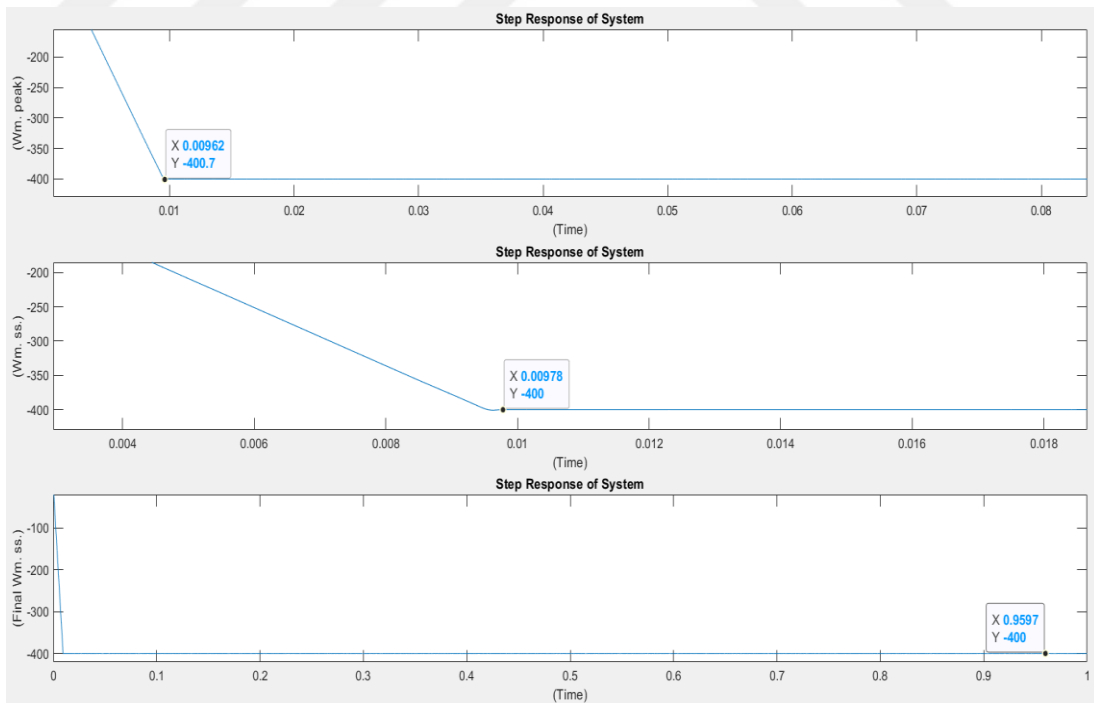

Figure 60: FLC (GA) (Multiple) (0)-(-400) (Wm_peak(rad/sec): -400.7, tr (sec.): 0.00962, Wm_ss(rad/sec): -400, ts (sec.): 0.0097, Final Wm_ss(rad/sec): -400)

5.2.16. FLC[14] 400-380

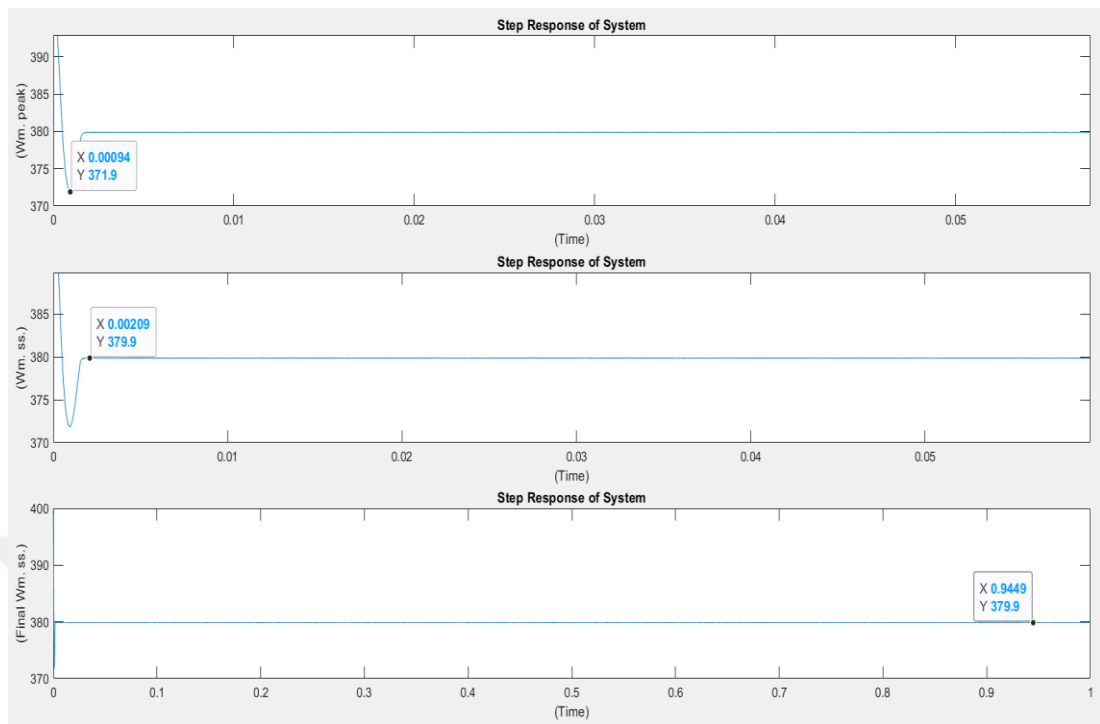

Figure 61: FLC[14] 400-380 (Wm_peak (rad/sec): 371.9, tr (sec.): 0.00094, Wm_ss (rad/sec): 379.9, ts (sec.): 0.00209, Final Wm_ss (rad/sec): 379.9)

5.2.17. PI(R.L)[14] 400-380

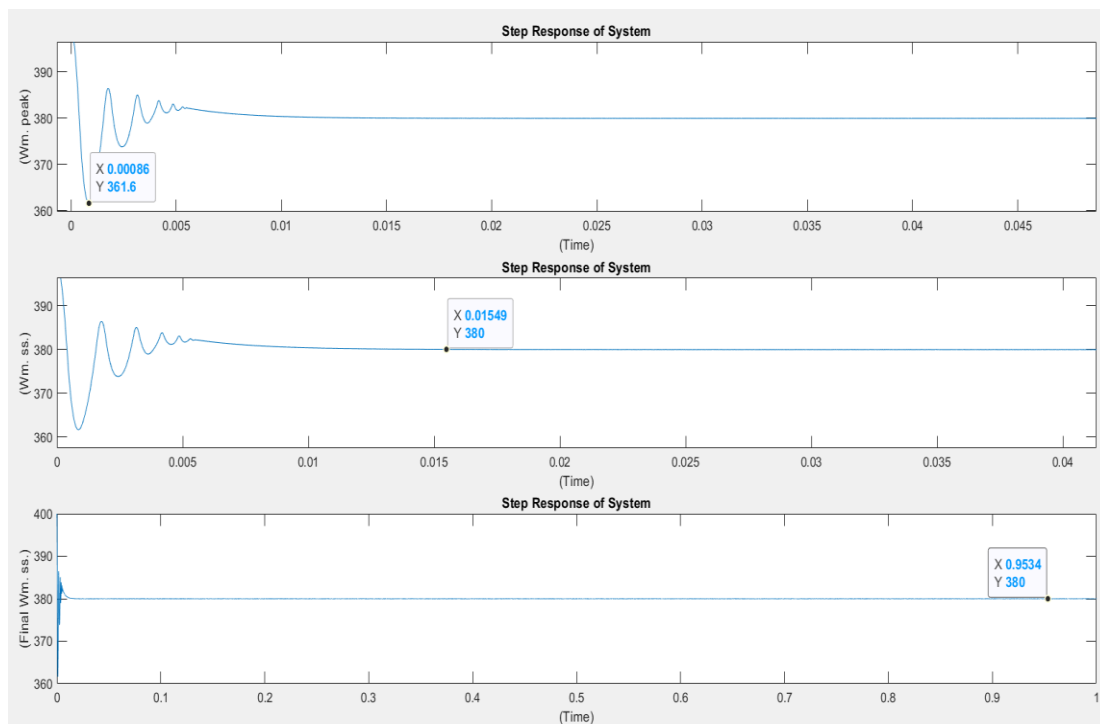

Figure 62: PI(R.L)[14] 400-380 (Wm_peak (rad/sec): 361.6, tr (sec.): 0.00086, Wm_ss (rad/sec): 380, ts (sec.): 0.015, Final Wm_ss (rad/sec): 380)

5.2.18. PI (GA)(Single) 400-380

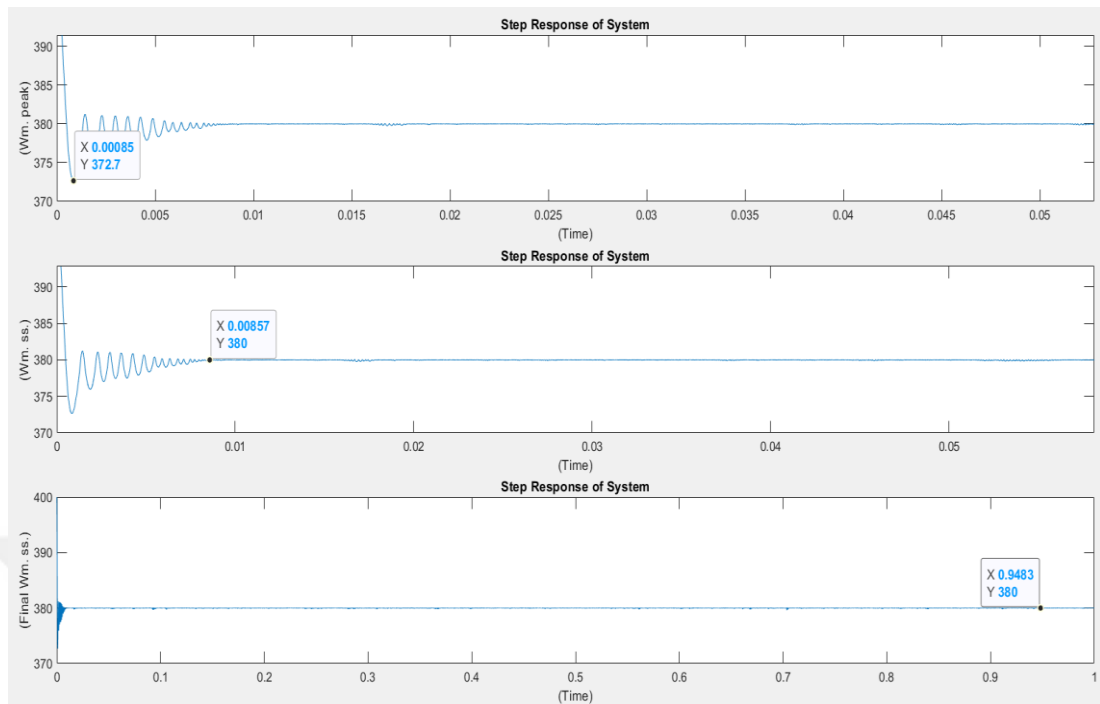

Figure 63: PI (GA)(Single) 400-380 (Wm_peak(rad/sec): 372.7, tr (sec.): 0.00085, Wm_ss(rad/sec): 380, ts (sec.): 0.0085, Final Wm_ss(rad/sec): 380)

5.2.19. PI (GA)(Multiple) 400-380

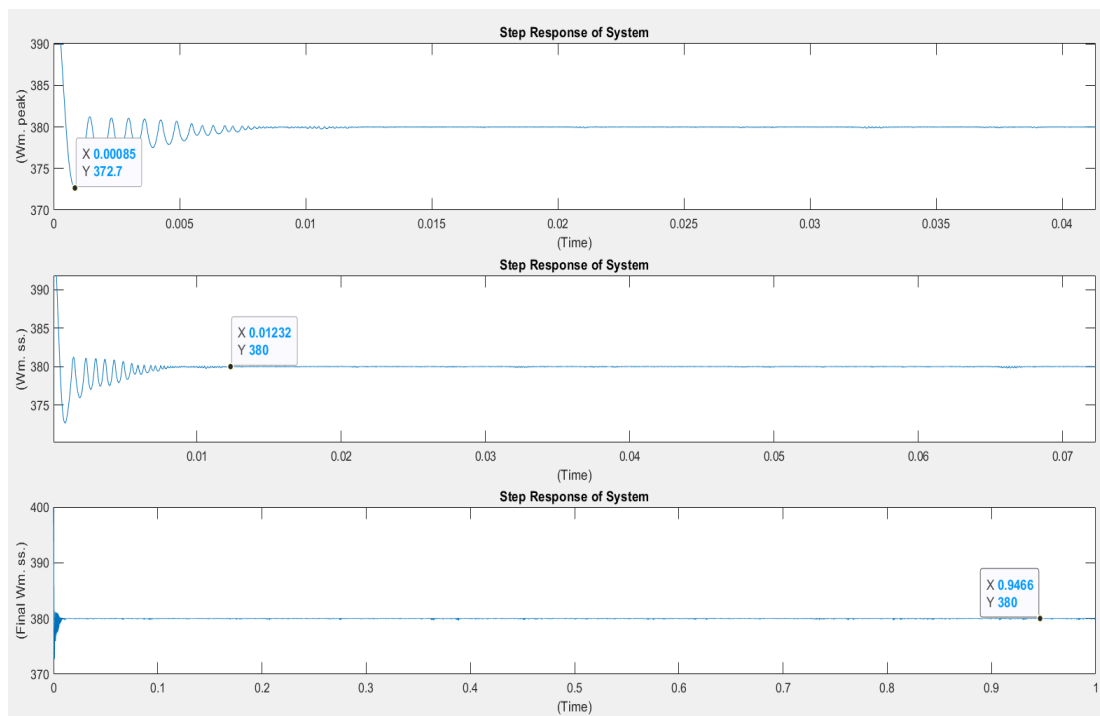

Figure 64: PI (GA)(Multiple) 400-380 (Wm_peak(rad/sec): 372.7, tr (sec.): 0.00085, Wm_ss(rad/sec): 380, ts (sec.): 0.0123, Final Wm_ss(rad/sec): 380)

5.2.20. FLC (GA)(Multiple) 400-380

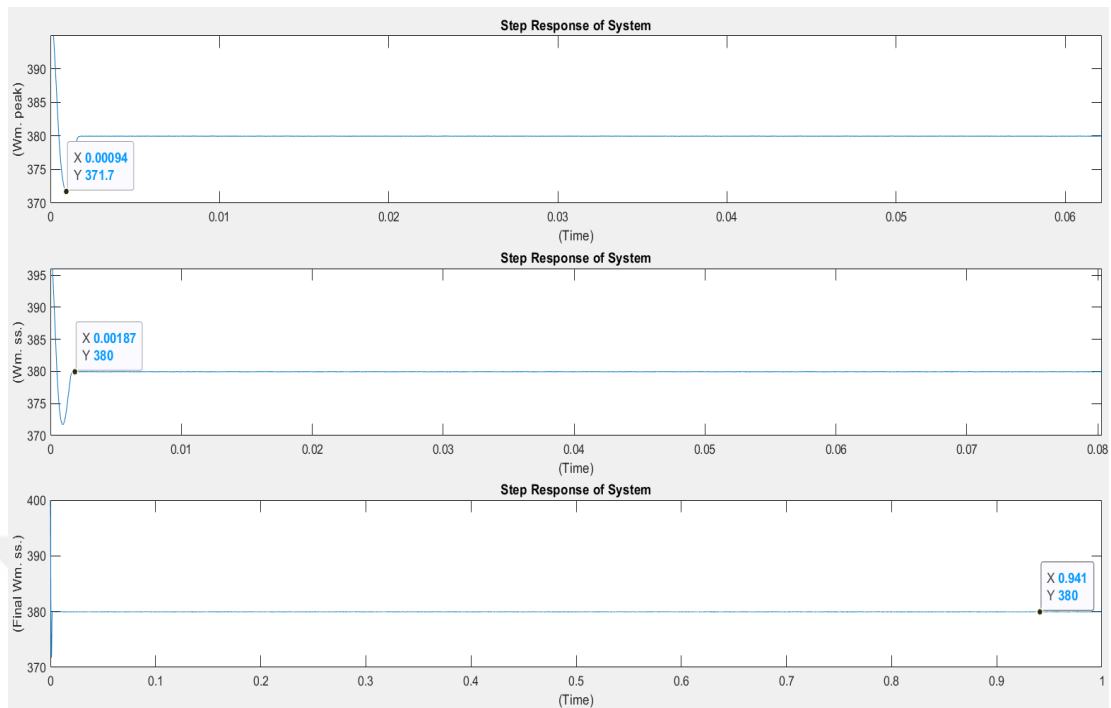

Figure 65: FLC (GA) (Multiple) 400-380 (Wm_peak(rad/sec): 371.7, tr (sec.): 0.00094, Wm_ss(rad/sec): 380, ts (sec.): 0.00187, Final Wm_ss(rad/sec): 380)

5.2.21. FLC[14] (-380)-(-400)

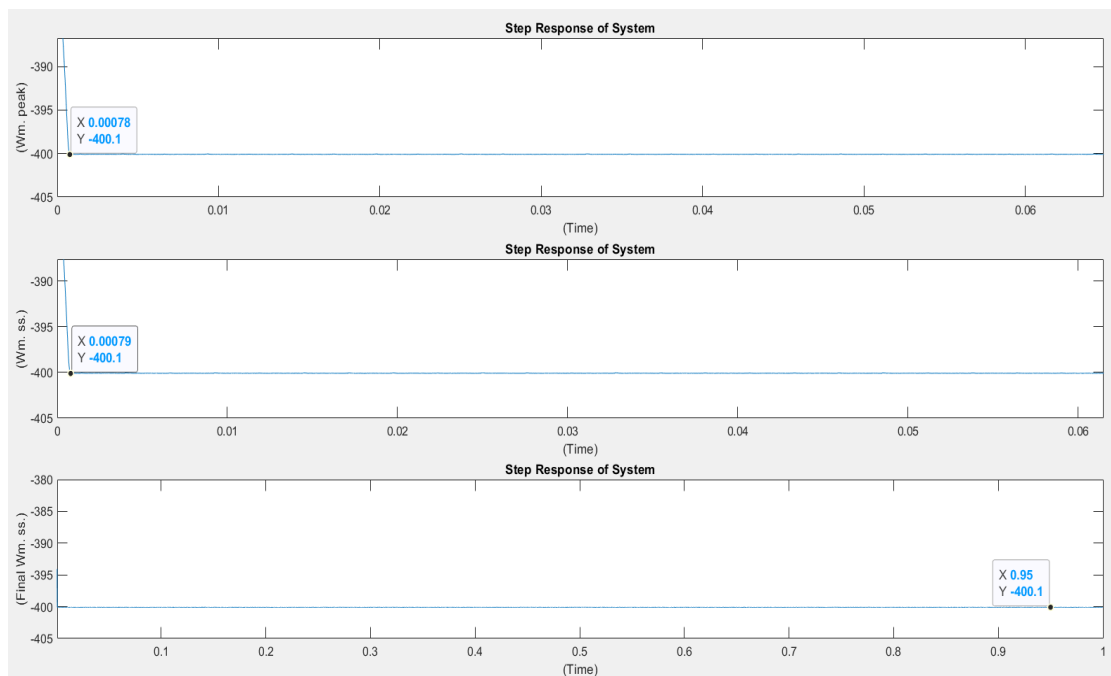

Figure 66: FLC[14] (-380)-(-400) (Wm_peak(rad/sec): -400.1, tr (sec.): 0.00078, Wm_ss(rad/sec): -400.1, ts (sec.): 0.00079, Final Wm_ss(rad/sec): -400.1)

5.2.22. PI(R.L)[14] (-380)-(-400)

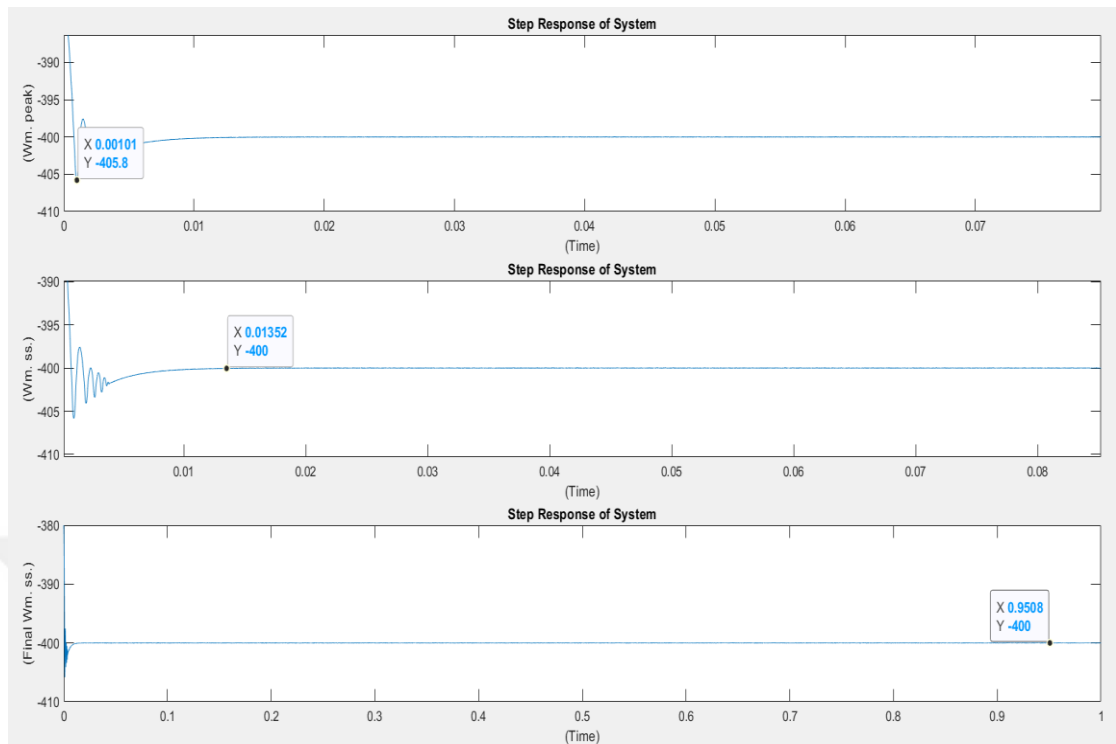

Figure 67: PI(R.L)[14] (-380)-(-400) (Wm_peak(rad/sec): -405.8, tr (sec.): 0.00101, Wm_ss(rad/sec): -400, ts (sec.): 0.0135, Final Wm_ss(rad/sec): -400)

5.2.23. PI (GA)(Single) (-380)-(-400)

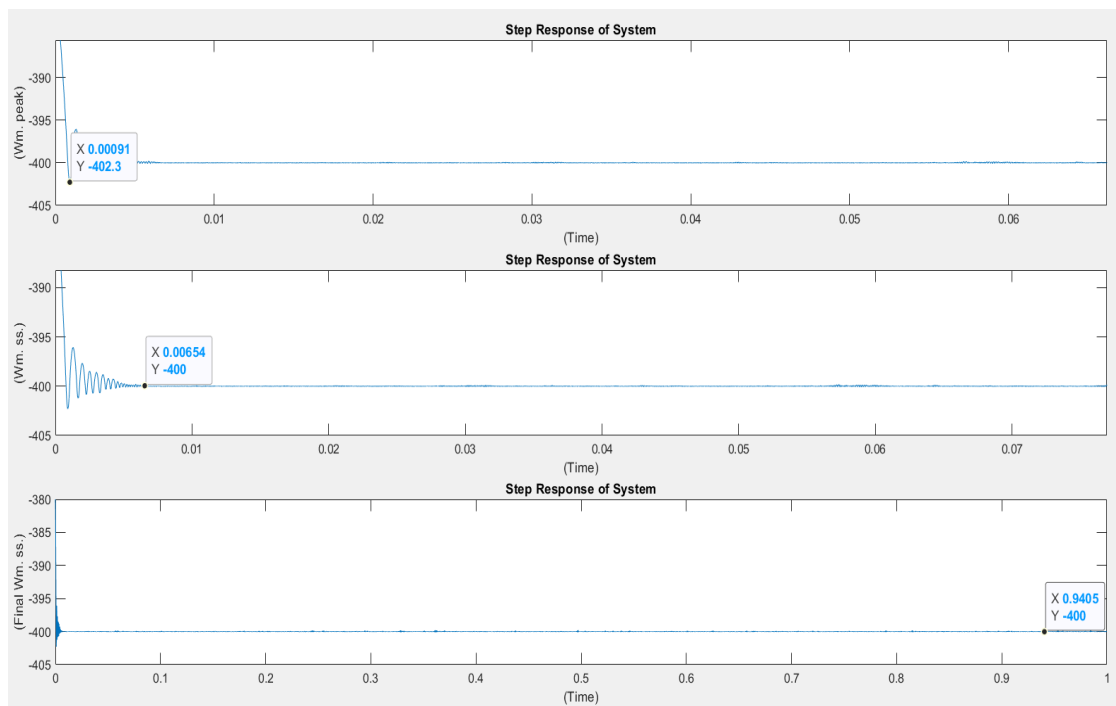

Figure 68: PI (GA)(Single) (-380)-(-400) (Wm_peak(rad/sec): -402.3, tr (sec.): 0.00091, Wm_ss(rad/sec): -400, ts (sec.): 0.0065, Final Wm_ss(rad/sec): -400)

5.2.24. PI (GA)(Multiple) (-380)-(-400)

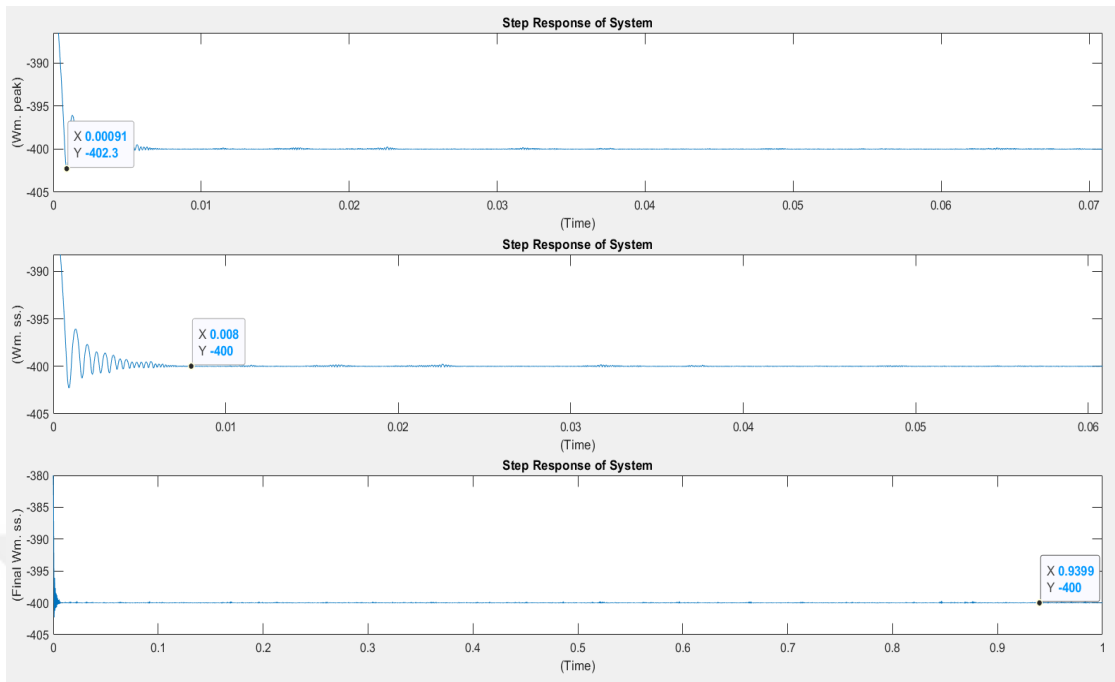

Figure 69: PI (GA)(Multiple) (-380)-(-400) (Wm_peak(rad/sec): -402.3, tr (sec.): 0.00091, Wm_ss(rad/sec): -400, ts (sec.): 0.0080, Final Wm_ss(rad/sec): -400)

5.2.25. FLC (GA)(Multiple) (-380)-(-400)

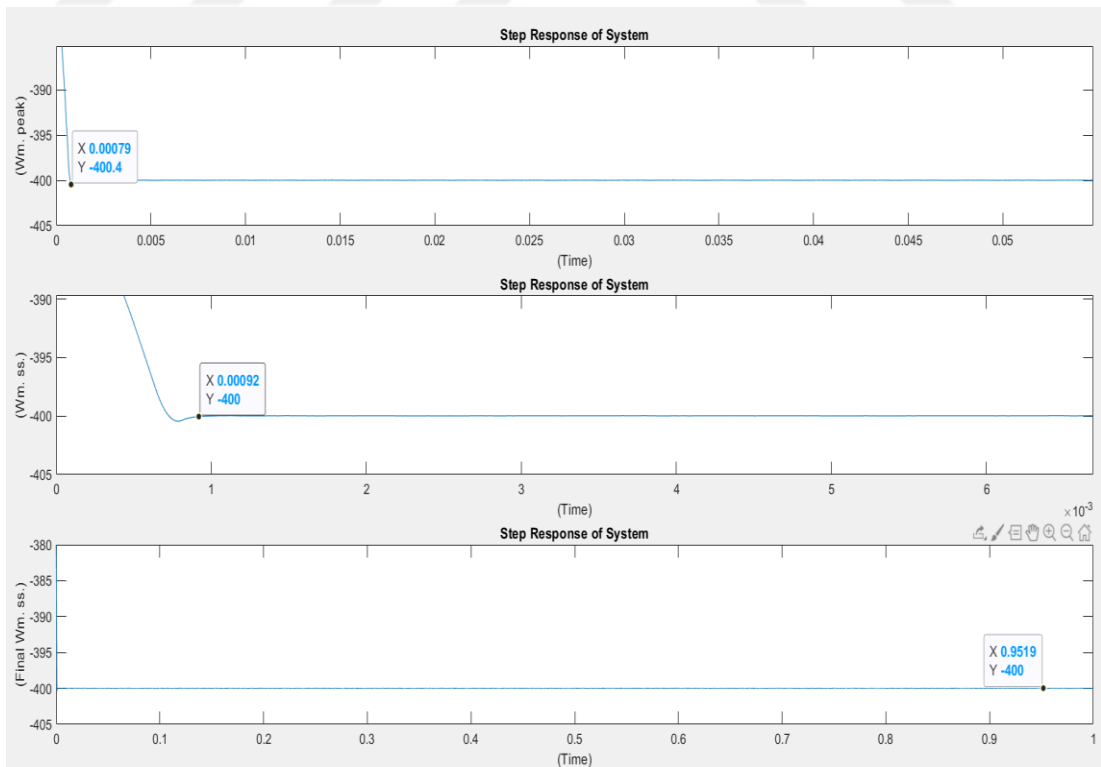

Figure 70: FLC (GA) (Multiple) (-380)-(-400) (Wm_peak(rad/sec): -400.4, tr (sec.): 0.00079, Wm_ss(rad/sec): -400, ts (sec.): 0.00092, Final Wm_ss(rad/sec): -400)

CASE 2 [(40)-(-20)], [(-20)-(-40)], [(0)-(-400)], [(400)-(380)], [(-380)-(-400)]

Table 9: Validation Phase (Case 2) Motor Ranges Results

40-20 (rad/sec)	FLC[14]	PI(R.L)[14]	PI(GA) (Single)	PI(GA) (Multiple)	FLC(GA) (Multiple)
Wm_peak(rad/sec), Max. Os%	17.95, 10.25%	5.33, 73.35%	15.07, 24.65%	15.07, 24.65%	17.54, 12.3%
tr (sec.)	0.00074	0.00089	0.00081	0.00081	0.00075
Wm_ss(rad/sec)	19.89	20	20	20	19.99
ts (sec.)	0.00122	0.014	0.0097	0.0100	0.00114
Final Wm_ss(rad/sec), Max. Os%	19.88, 0.6%	20, 0%	20, 0%	20, 0%	19.99, 0.05%

40-20 FLC[14], PI(R.L)[14], PI(GA)(Single), PI(GA)(Multiple), FLC(GA)(Multiple)

(-20)-(-40) (rad/sec)	FLC[14]	PI(R.L)[14]	PI(GA) (Single)	PI(GA) (Multiple)	FLC(GA) (Multiple)
Wm_peak(rad/sec), Max. Os%	-41.68, 4.2%	-53.14, 32.85%	-44.72, 11.8%	-44.72, 11.8%	-41.96, 4.9%
tr (sec.)	0.00073	0.00087	0.0008	0.0008	0.00074
Wm_ss(rad/sec)	-40.12	-40	-40	-40	-40
ts (sec.)	0.00137	0.0146	0.0080	0.0092	0.00122
Final Wm_ss(rad/sec), Max. Os%	-40.12, 0.29%	-40, 0%	-40, 0%	-40, 0%	-40, 0%

(-20)-(-40) FLC[14], PI(R.L)[14], PI(GA)(Single), PI(GA)(Multiple), FLC(GA)(Multiple)

(0)-(-400) (rad/sec)	FLC[14]	PI(R.L)[14]	PI(GA) (Single)	PI(GA) (Multiple)	FLC(GA) (Multiple)
Wm_peak(rad/sec), Max. Os%	-400.3, 0.07%	-545.2, 36.3%	-401.6, 0.40%	-401.8, 0.45%	-400.7, 0.175%
tr (sec.)	0.00962	0.0140	0.0100	0.0100	0.00962
Wm_ss(rad/sec)	-400.1	-400	-400	-400	-400
ts (sec.)	0.0098	0.036	0.0151	0.0165	0.0097
Final Wm_ss(rad/sec), Max. Os%	-400.1, 0.25%	-400, 0%	-400, 0%	-400, 0%	-400, 0%

(0)-(-400) FLC[14], PI(R.L)[14], PI(GA)(Single), PI(GA)(Multiple), FLC(GA)(Multiple)

400-380 (rad/sec)	FLC[14]	PI(R.L)[14]	PI(GA) (Single)	PI(GA) (Multiple)	FLC(GA) (Multiple)
Wm_peak(rad/sec), Max. Os%	371.9, 2.13%	361.6, 4.84%	372.7, 1.92%	372.7, 1.92%	371.7, 2.18%
tr (sec.)	0.00094	0.00086	0.00085	0.00085	0.00094
Wm_ss(rad/sec)	379.9	380	380	380	380
ts (sec.)	0.00209	0.015	0.0085	0.0123	0.00187
Final Wm_ss(rad/sec), Max. Os%	379.9, 0.02%	380, 0%	380, 0%	380, 0%	380, 0%

400-380 FLC[14], PI(R.L)[14], PI(GA)(Single), PI(GA)(Multiple), FLC(GA)(Multiple)

(-380)-(-400) (rad/sec)	FLC[14]	PI(R.L)[14]	PI(GA) (Single)	PI(GA) (Multiple)	FLC(GA) (Multiple)
Wm_peak(rad/sec), Max. Os%	-400.1, 0.025%	-405.8, 1.45%	-402.3, 0.57%	-402.3, 0.57%	-400.4, 0.1%
tr (sec.)	0.00078	0.00101	0.00091	0.00091	0.00079
Wm_ss(rad/sec)	-400.1	-400	-400	-400	-400
ts (sec.)	0.00079	0.0135	0.0065	0.0080	0.00092
Final Wm_ss(rad/sec), Max. Os%	-400.1, 0.025%	-400, 0%	-400, 0%	-400, 0%	-400, 0%

(-380)-(-400) FLC[14],PI(R.L)[14],PI(GA)(Single),PI(GA)(Multiple),FLC(GA)(Multiple)

5.2.26. VALIDATION PHASE (CASE 2) RESULTS

In the validation simulations, the best controller structures obtained at optimization phases and the controllers obtained in [14] are compared. This time the controller is let drive the BLDC motor in the opposite direction according to the speed rangers given in Table 4 under the same conditions explained in Section 5.1.36.

As seen, controller PI(R.L)[14] has the highest percentage overshoot and settling time values. Its performance is satisfactory for the steady-state error value as the motor reaches the reference angular speed value in each validation simulation.

FLC[14] controller shows minimum percentage overshoot with generally good settling time performance. However, FLC[14] always have a very slight steady-state error value.

Multiple PI Approach and Single PI Approach results are better compared to PI(R.L)[14] in all categories. However, they show only better results in terms of steady-state error values compared to FLC[14]. For other performance criteria FLC[14] is superior.

Comparing both Single PI Approach and Multiple PI Approach results, one can conclude that there is not a significant difference between them except the settling time. For settling time Single PI Approach demonstrate better results.

Multiple FLC Approach presents the very close values to FLC[14] in terms of rise time and for most of the case its settling time value is the best among all other controllers. Besides for most of the cases its steady-state error value is approaching to 0. There is only a small difference compared to FLC[14] in terms of percentage overshoot. Hence one can make the conclusion that it has the best transient behavior compared to other controllers in the validation scenarios.

CHAPTER 6

EFFECT OF NORMALIZATION OF COST FUNCTION

The effect of normalizing the performance index weights in the optimization phase is considered in this chapter in case Multiple FLC Approach is used. For this reason, the cost function given in Equation 2 is adjusted and two new cost functions are defined. These cost functions are,

$$\text{Cost} = \text{norm_rise_time} + \text{norm_percentage_overshoot} + \text{norm_percentage_steady_state_error} \quad (7)$$

$$\text{Cost} = \text{norm_rise_time} + \text{norm_settling_time} + \text{norm_percentage_steady_state_error} \quad (8)$$

In these new cost functions, the performance criteria parameters are normalized and the effect of normalization in the optimization process is checked. As seen from Equation 7 and Equation 8, effect of undershoot is totally excluded from the equations as no undershoot is encountered in the previous simulations. Besides in Equation 7 effect of settling time and in Equation 8 effect of percentage overshoot is excluded to demonstrate the comparative effects of different performance criteria in the simulations. The normalization of the performance criteria is performed as follows:

Depending on the results of Chapter 5, nearly the minimum values of settling time and rise time are recorded for all speed ranges. These minimum values are divided by the speed ranges and some characteristic values are obtained for normalization. It is observed that these values are 2 or 3 times smaller than 10^{-4} when it is done for rise time and 2 or 3 times smaller than 1.625×10^{-4} when it is done for settling time. Hence normalization of all performance criteria is defined as,

$$\begin{aligned} \text{if } \frac{\text{rise_time}}{\text{speed_range}} \geq 10^{-4} \text{ then } \text{norm_rise_time} &= 1 \\ \text{else } \text{norm_rise_time} &= \frac{1}{10^{-4}} \times \frac{\text{rise_time}}{\text{speed_range}} \end{aligned} \quad (9)$$

$$\text{if } \frac{\text{settling_time}}{\text{speed_range}} \geq 1.625 \times 10^{-4} \text{ then } \text{norm_settling_time} = 1 \quad (10)$$

$$\text{else } \text{norm_settling_time} = \frac{1}{1.625 \times 10^{-4}} \times \frac{\text{settling_time}}{\text{speed_range}}$$

$$\text{norm_percentage_overshoot} = \frac{\text{percentage_overshoot}}{100} \quad (11)$$

$$\text{norm_percentage_steady_state_error} = \frac{\text{percentage_steady_state_error}}{100} \quad (12)$$

Using the Equations 9, 10, 11, 12 inside Equation 7 and Equation 8 the cost in a single speed range is obtained and then using Equation 5 and then Equation 6 the fitness function accounting all speed ranges is calculated. In these new optimization simulations, the GA parameters are taken as;

Number of generations: 40,

Number of chromosomes in each generation: 40,

Mutation rate: 0.05,

Reproduction rate: 0.05 (with elitism method),

Crossover rate: 0.9,

Step size= 0.0001 (as the step size is decreased optimization simulations for a chromosome takes higher computation time. But as an advantage better chromosome emerges at the early steps of the optimization runs)

Problem Solver: Runge Kutta

The results are as follows:

Table 10: Best Chromosomes for FLC (GA Multiple) Norm 1&2 Controller

Test Results_FLC (GA Multiple) Norm 1&2	ALL RANGES		
	Ne1,Ne2,Nu 1/K1,1/K2,K3 NORM 1	416.3573	1.6265e+07
Ne1,Ne2,Nu 1/K1,1/K2,K3 NORM 2	822.2741	1.1484e+07	3.7017e+03

6.1. FLC NORMALIZATION 1 FOR OPTIMIZATION PHASE (CASE 1)

6.1.1. FLC (GA)(Multiple) Norm 1 0-20

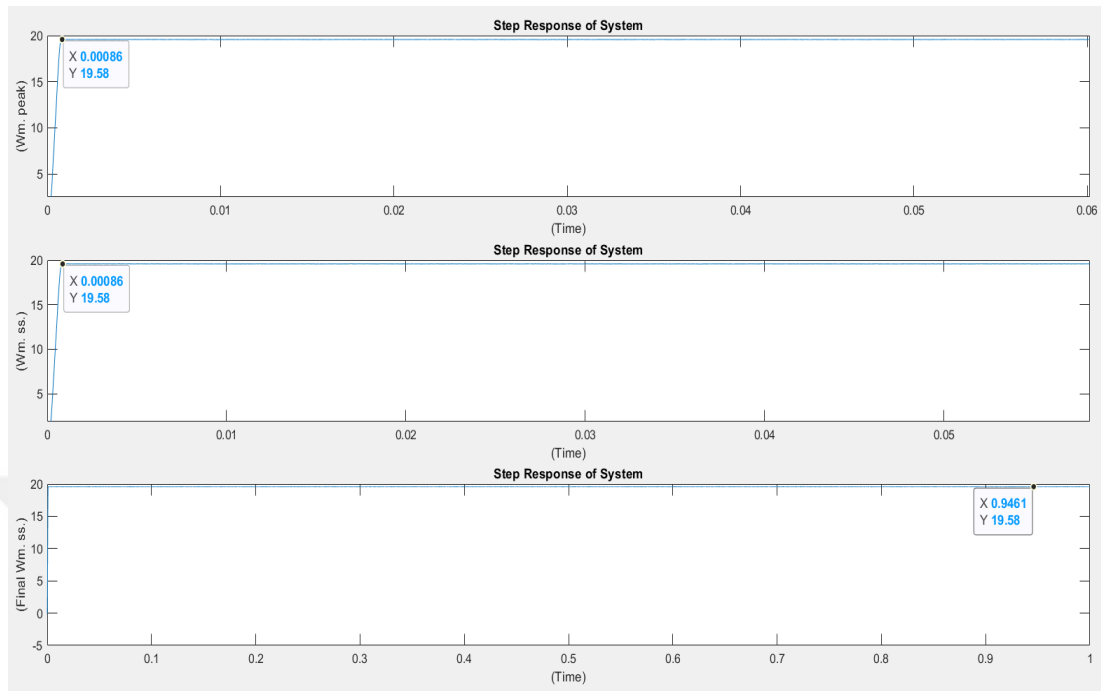

Figure 71: FLC (GA) (Multiple) Norm 1 (0)-(20) (Wm_peak(rad/sec): 19.58, tr (sec.): 0.00086, Wm_ss(rad/sec): 19.58, ts (sec.): 0.00086, Final Wm_ss(rad/sec): 19.58)

6.1.2. FLC (GA)(Multiple) Norm 1 20-40

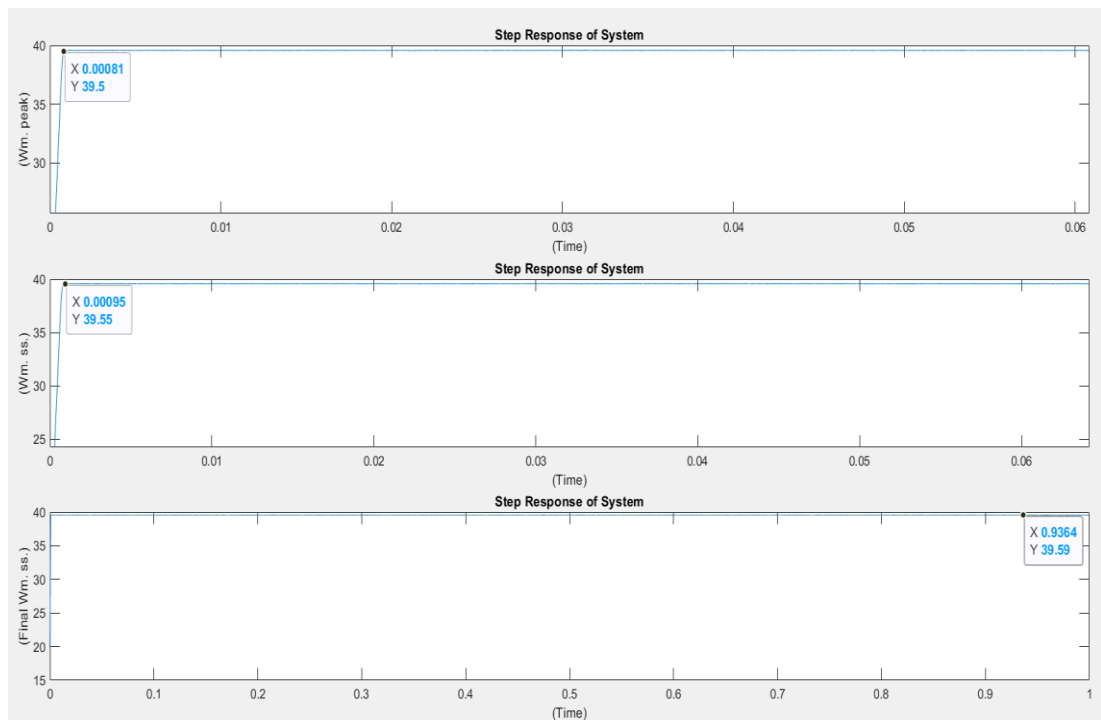

Figure 72: FLC (GA) (Multiple) Norm 1 (20)-(40) (Wm_peak(rad/sec): 39.5, tr (sec.): 0.00081, Wm_ss(rad/sec): 39.55, ts (sec.): 0.00095, Final Wm_ss(rad/sec): 39.59)

6.1.3. FLC (GA)(Multiple) Norm 1 0-100

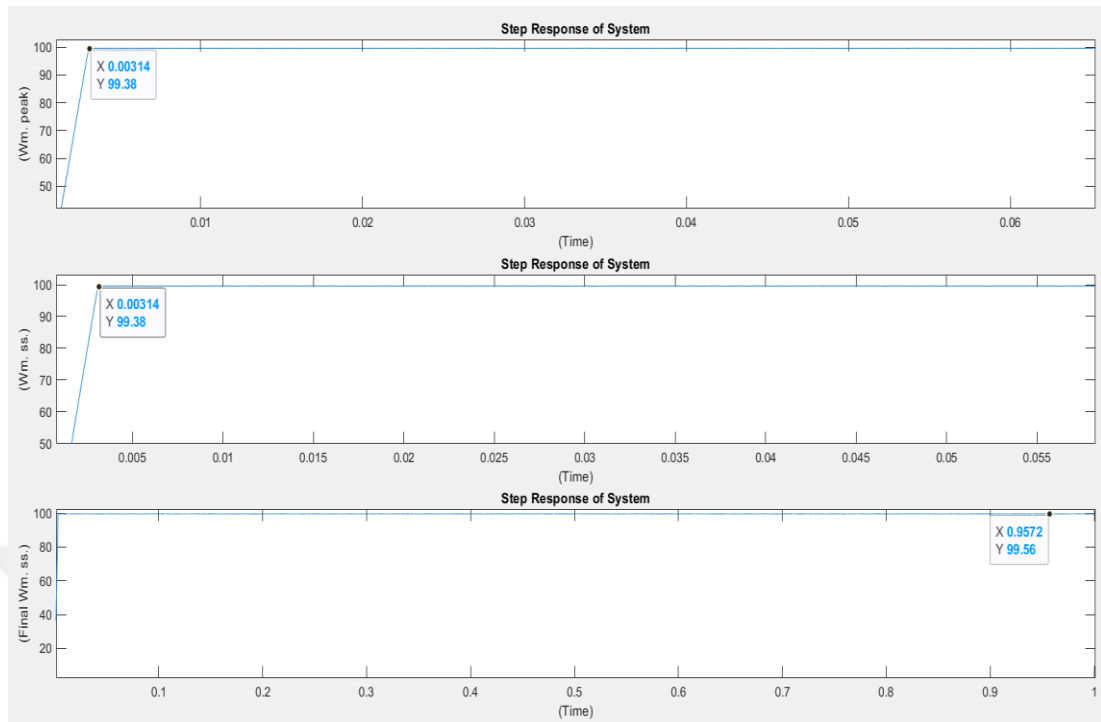

Figure 73: FLC (GA) (Multiple) Norm 1 (0)-(100) (Wm_peak(rad/sec): 99.38, tr (sec.): 0.00314, Wm_ss(rad/sec): 99.38, ts (sec.): 0.00314, Final Wm_ss(rad/sec): 99.56)

6.1.4. FLC (GA)(Multiple) Norm 1 0-400

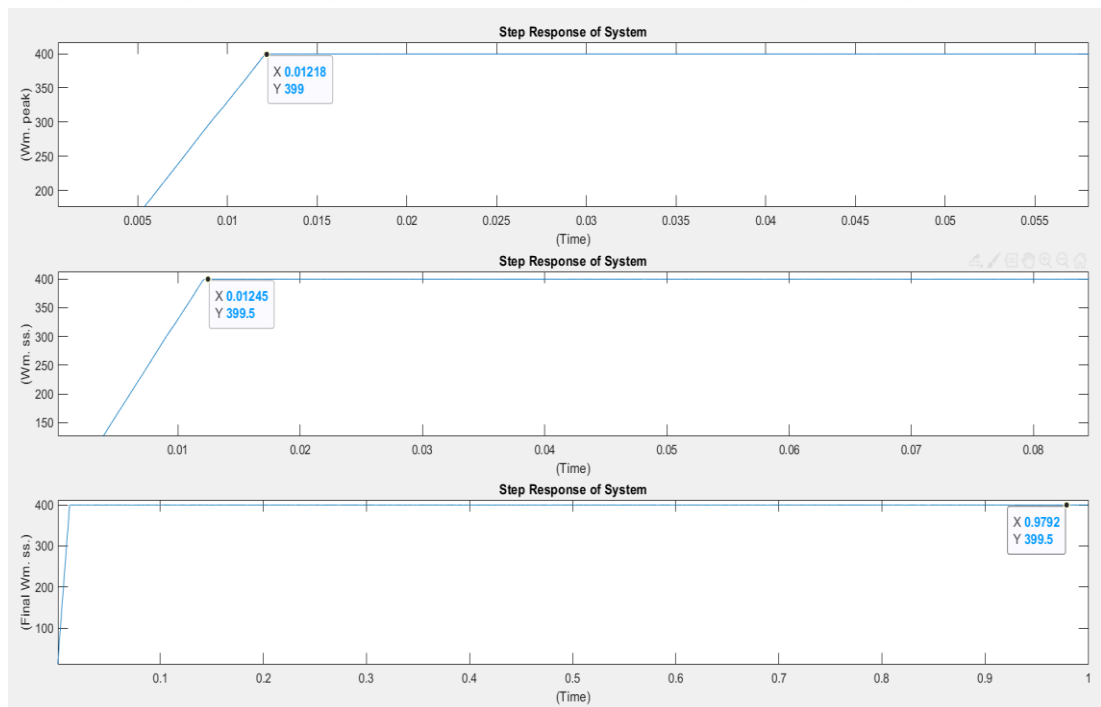

Figure 74: FLC (GA) (Multiple) Norm 1 (0)-(400) (Wm_peak(rad/sec): 399, tr (sec.): 0.01218, Wm_ss(rad/sec): 399.5, ts (sec.): 0.01245, Final Wm_ss(rad/sec): 399.5)

6.1.5. FLC (GA)(Multiple) Norm 1 200-400

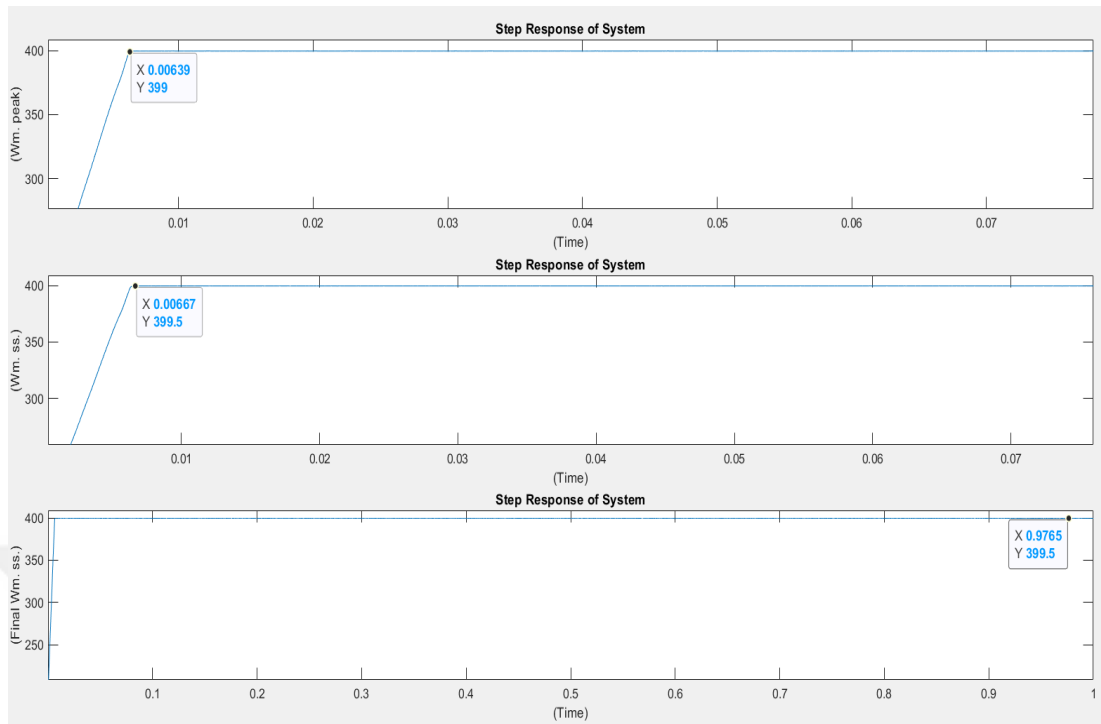

Figure 75: FLC (GA) (Multiple) Norm 1 (200)-(400) (Wm_peak (rad/sec): 399, tr (sec.): 0.00639, Wm_ss (rad/sec): 399.5, ts (sec.): 0.00667, Final Wm_ss (rad/sec): 399.5)

6.1.6. FLC (GA)(Multiple) Norm 1 380-400

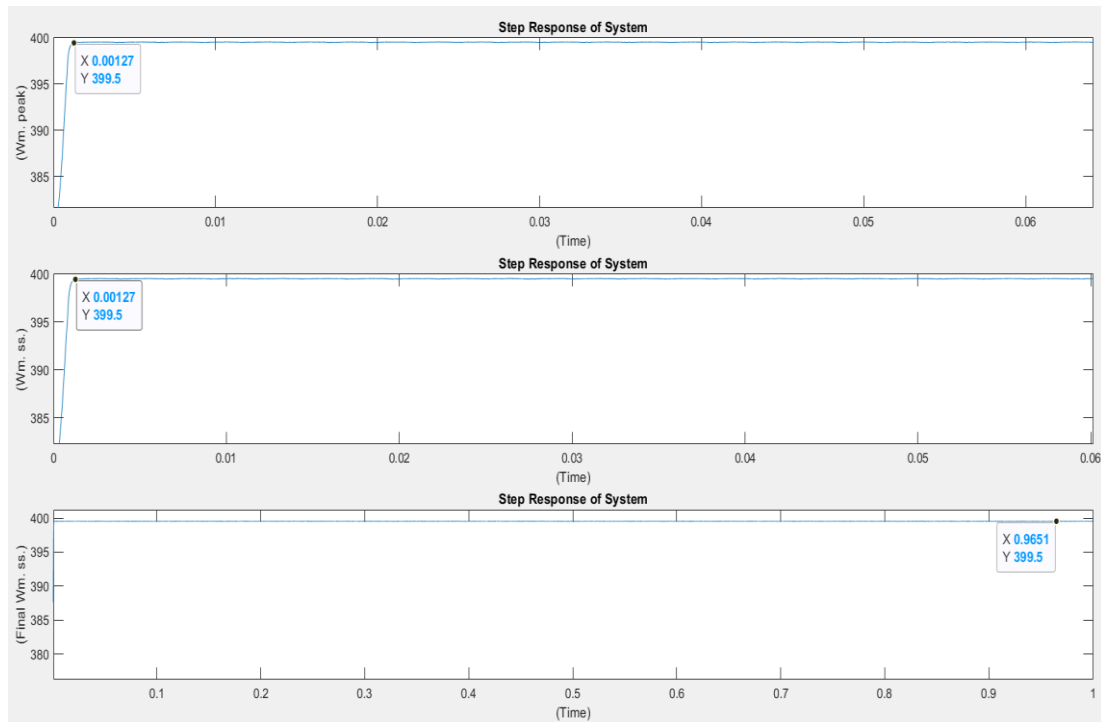

Figure 76: FLC (GA) (Multiple) Norm 1 (380)-(400) (Wm_peak (rad/sec): 399.5, tr (sec.): 0.00127, Wm_ss (rad/sec): 399.5, ts (sec.): 0.00127, Final Wm_ss (rad/sec): 399.5)

6.1.7. FLC (GA)(Multiple) Norm 1 300-350

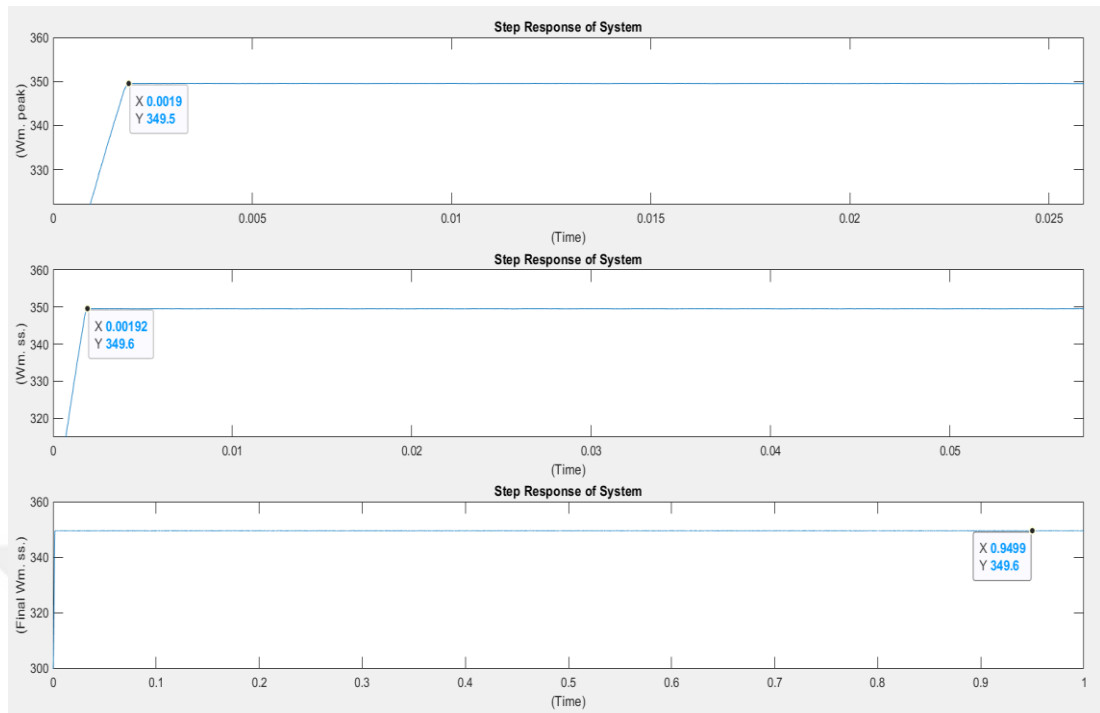

Figure 77: FLC (GA) (Multiple) Norm 1 (300)-(350) (Wm_peak(rad/sec): 349.5, tr (sec.): 0.0019, Wm_ss(rad/sec): 349.6, ts (sec.): 0.00192, Final Wm_ss(rad/sec): 349.6)

6.2. FLC NORMALIZATION 2 FOR OPTIMIZATION PHASE (CASE 1)

6.2.1. FLC (GA)(Multiple) Norm 2 0-20

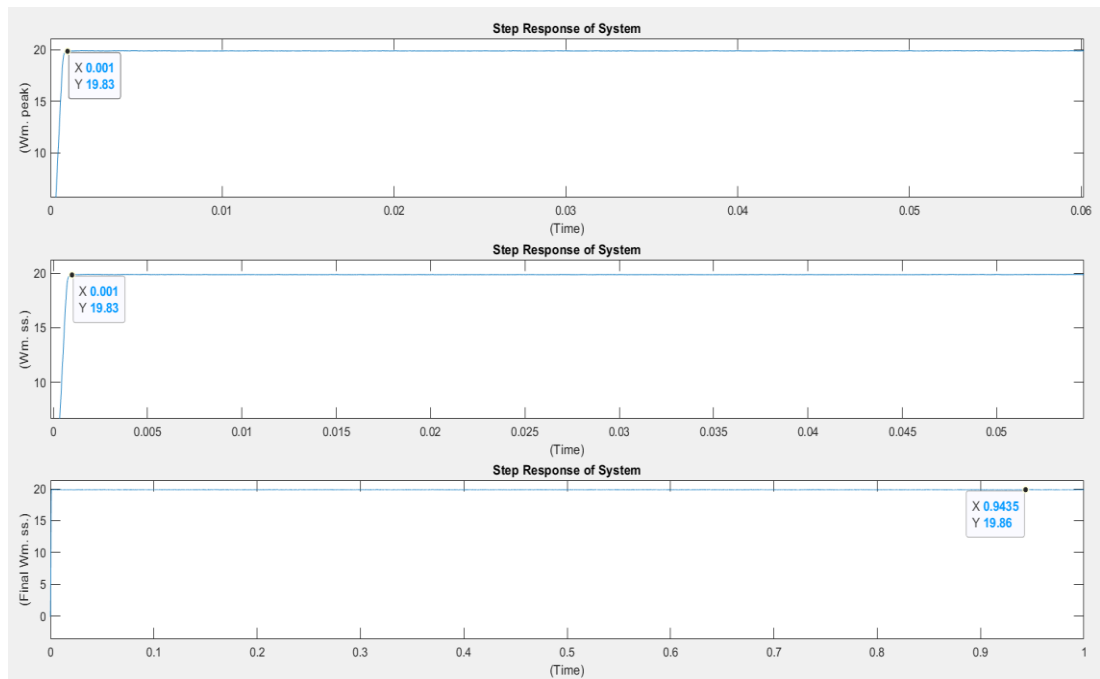

Figure 78: FLC (GA) (Multiple) Norm 2 (0)-(20) (Wm_peak(rad/sec): 19.83, tr (sec.): 0.001, Wm_ss(rad/sec): 19.83, ts (sec.): 0.001, Final Wm_ss(rad/sec): 19.86)

6.2.2. FLC (GA)(Multiple) Norm 2 20-40

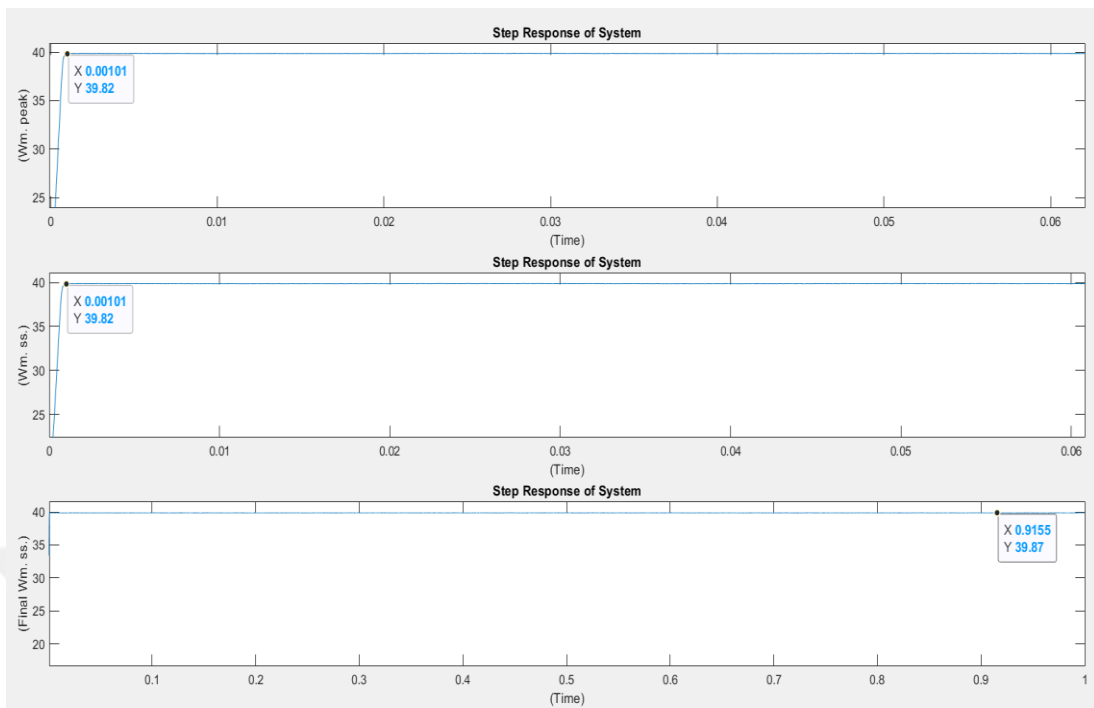

Figure 79: FLC (GA) (Multiple) Norm 2 (20)-(40) (Wm_peak(rad/sec): 39.82, tr (sec.): 0.001, Wm_ss(rad/sec): 39.82, ts (sec.): 0.001, Final Wm_ss(rad/sec): 39.87)

6.2.3. FLC (GA)(Multiple) Norm 2 0-100

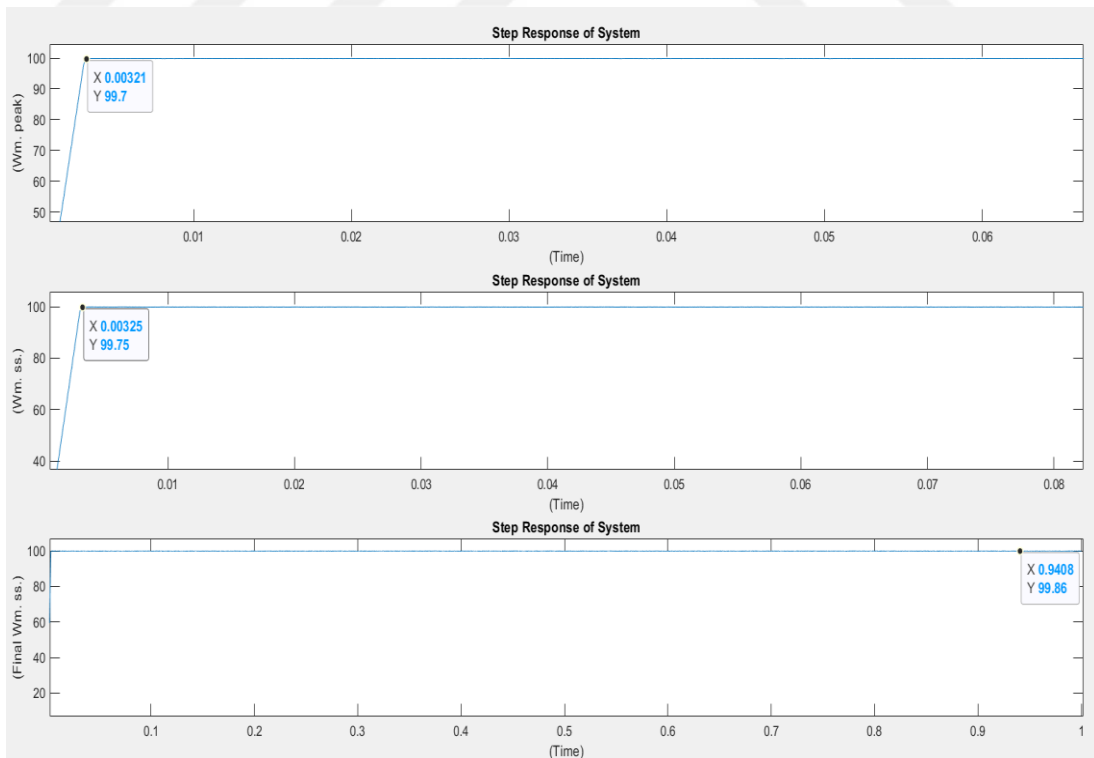

Figure 80: FLC (GA) (Multiple) Norm 2 (0)-(100) (Wm_peak(rad/sec): 99.7, tr (sec.): 0.0032, Wm_ss(rad/sec): 99.75, ts (sec.): 0.0032, Final Wm_ss(rad/sec): 99.86)

6.2.4. FLC (GA)(Multiple) Norm 2 0-400

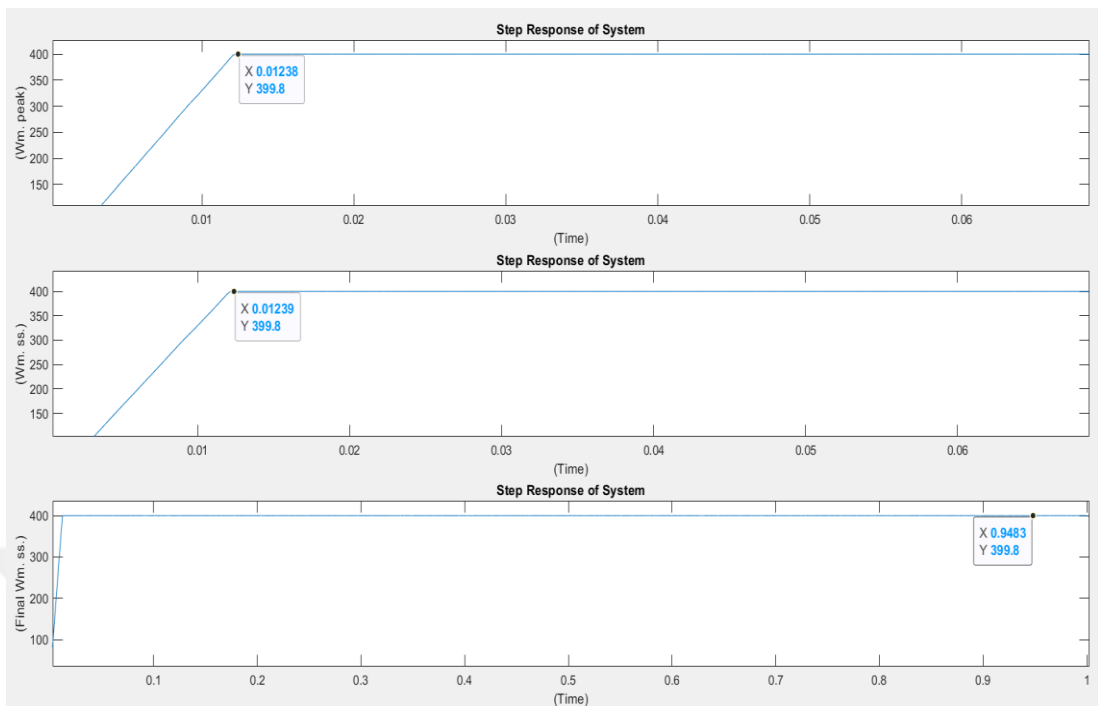

Figure 81: FLC (GA) (Multiple) Norm 2 (0)-(400) (Wm_peak(rad/sec): 399.8, tr (sec.): 0.012, Wm_ss(rad/sec): 399.8, ts (sec.): 0.012, Final Wm_ss(rad/sec): 399.8)

6.2.5. FLC (GA)(Multiple) Norm 2 200-400

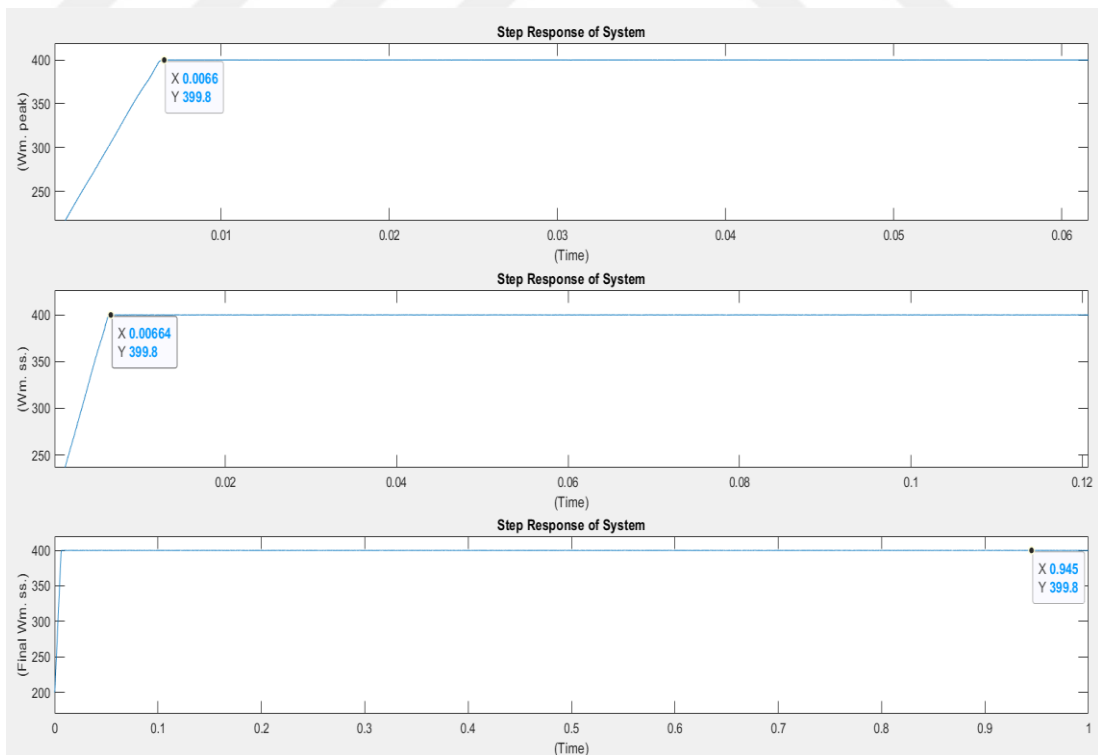

Figure 82: FLC (GA) (Multiple) Norm 2 (200)-(400) (Wm_peak(rad/sec): 399.8, tr (sec.): 0.0066, Wm_ss(rad/sec): 399.8, ts (sec.): 0.0066, Final Wm_ss(rad/sec): 399.8)

6.2.6. FLC (GA)(Multiple) Norm 2 380-400

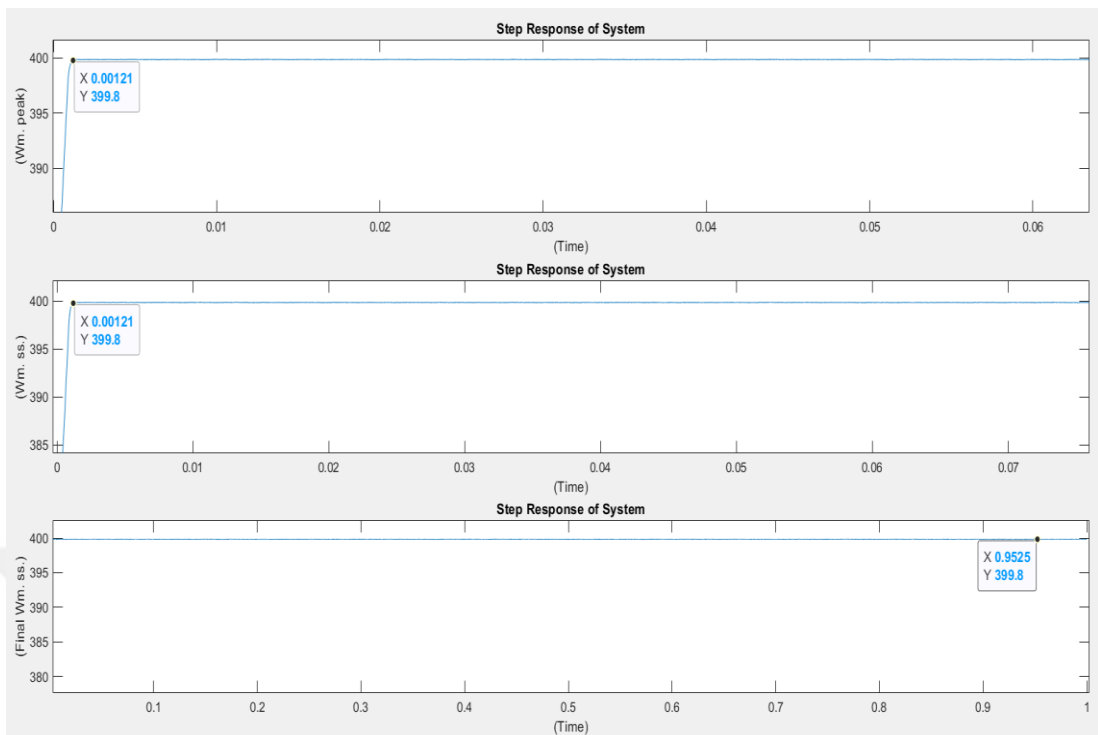

Figure 83: FLC (GA) (Multiple) Norm 2 (380)-(400) (Wm_peak(rad/sec): 399.8, tr (sec.): 0.0012, Wm_ss(rad/sec): 399.8, ts (sec.): 0.0012, Final Wm_ss(rad/sec): 399.8)

6.2.7. FLC (GA)(Multiple) Norm 2 300-350

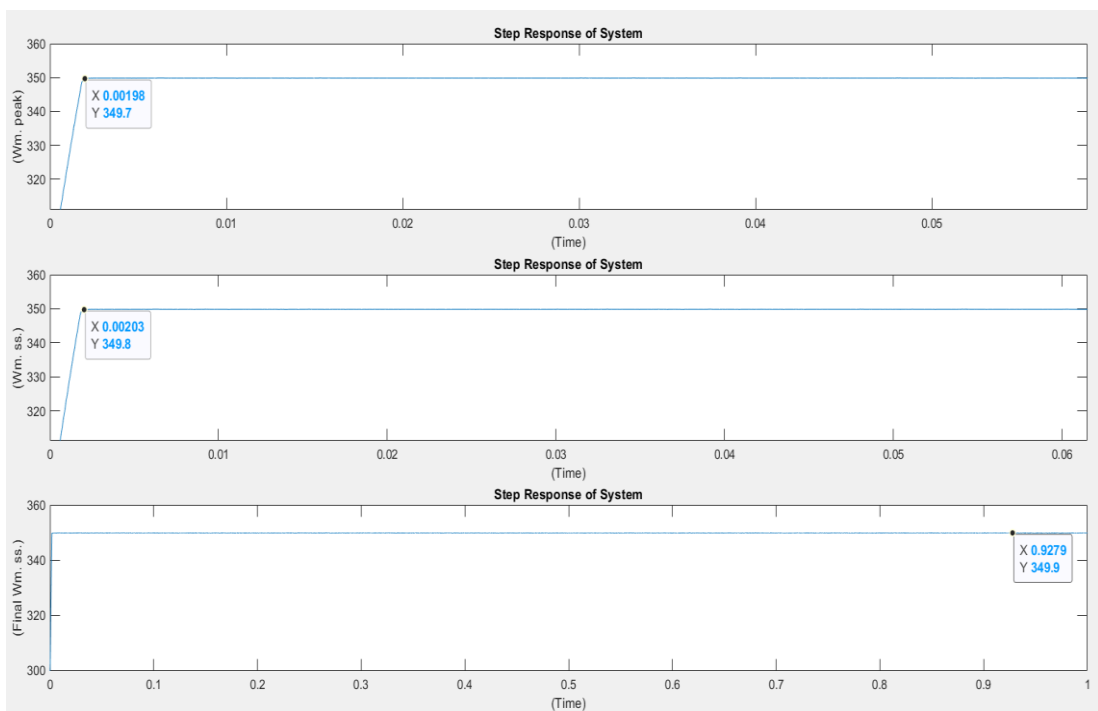

Figure 84: FLC (GA) (Multiple) Norm 2 (300)-(350) (Wm_peak(rad/sec): 349.7, tr (sec.): 0.0019, Wm_ss(rad/sec): 349.8, ts (sec.): 0.0020, Final Wm_ss(rad/sec): 349.9)

TABLE 11: FLC (GA Multiple) Normalization 1&2 For Case 1

0-20 (rad/sec)	FLC (GA) (Multiple)	FLC (GA) (Multiple) Norm 1	FLC (GA) (Multiple) Norm 2
Wm_peak(rad/sec), Max. Os%	21.1, 5.5%	19.58, 2.1%	19.83, 0.85%
tr (sec.)	0.0008	0.0008	0.001
Wm_ss(rad/sec)	20	19.58	19.83
ts (sec.)	0.0011	0.0008	0.001
Final Wm_ss(rad/sec), Max. Os%	19.99, 0.05%	19.58, 2.1%	19.86, 0.7%

0-20 FLC (GA)(Multiple), FLC (GA)(Multiple) Norm 1, FLC (GA)(Multiple) Norm 2

20-40 (rad/sec)	FLC (GA) (Multiple)	FLC (GA) (Multiple) Norm 1	FLC (GA) (Multiple) Norm 2
Wm_peak(rad/sec), Max. Os%	40.79, 1.97%	39.5, 1.25%	39.82, 0.45%
tr (sec.)	0.0008	0.0008	0.001
Wm_ss(rad/sec)	40	39.55	39.82
ts (sec.)	0.0011	0.00095	0.001
Final Wm_ss(rad/sec), Max. Os%	39.99, 0.025%	39.59, 1.025%	39.87, 0.325%

20-40 FLC (GA)(Multiple), FLC (GA)(Multiple) Norm 1, FLC (GA)(Multiple) Norm 2

0-100 (rad/sec)	FLC (GA) (Multiple)	FLC (GA) (Multiple) Norm 1	FLC (GA) (Multiple) Norm 2
Wm_peak(rad/sec), Max. Os%	101, 1%	99.38, 0.62%	99.7, 0.3%
tr (sec.)	0.0032	0.0031	0.0032
Wm_ss(rad/sec)	100	99.38	99.75
ts (sec.)	0.0034	0.0031	0.0032
Final Wm_ss(rad/sec), Max. Os%	99.99, 0.01%	99.56, 0.44%	99.86, 0.14%

0-100 FLC (GA)(Multiple), FLC (GA)(Multiple) Norm 1, FLC (GA)(Multiple) Norm 2

0-400 (rad/sec)	FLC (GA) (Multiple)	FLC (GA) (Multiple) Norm 1	FLC (GA) (Multiple) Norm 2
Wm_peak(rad/sec), Max. Os%	400, 0%	399, 0.25%	399.8, 0.05%
tr (sec.)	0.012	0.012	0.012
Wm_ss(rad/sec)	400	399.5	399.8
ts (sec.)	0.012	0.012	0.012
Final Wm_ss(rad/sec), Max. Os%	400, 0%	399.5, 0.25%	399.8, 0.05%

0-400 FLC (GA)(Multiple), FLC (GA)(Multiple) Norm 1, FLC (GA)(Multiple) Norm 2

200-400 (rad/sec)	FLC (GA) (Multiple)	FLC (GA) (Multiple) Norm 1	FLC (GA) (Multiple) Norm 2
Wm_peak(rad/sec), Max. Os%	399.9, 0.025%	399, 0.25%	399.8, 0.05%
tr (sec.)	0.0064	0.0063	0.0066
Wm_ss(rad/sec)	400	399.5	399.8
ts (sec.)	0.0066	0.0066	0.0066
Final Wm_ss(rad/sec), Max. Os%	400, 0%	399.5, 0.125%	399.8, 0.05%

200-400 FLC (GA)(Multiple), FLC (GA)(Multiple) Norm 1, FLC (GA)(Multiple) Norm 2

380-400 (rad/sec)	FLC (GA) (Multiple)	FLC (GA) (Multiple) Norm 1	FLC (GA) (Multiple) Norm 2
Wm_peak(rad/sec), Max. Os%	400, 0%	399.5, 0.125%	399.8, 0.05%
tr (sec.)	0.0012	0.0012	0.0012
Wm_ss(rad/sec)	400	399.5	399.8
ts (sec.)	0.0013	0.0012	0.0012
Final Wm_ss(rad/sec), Max. Os%	400, 0%	399.5, 0.125%	399.8, 0.05%

380-400 FLC (GA)(Multiple), FLC (GA)(Multiple) Norm 1, FLC (GA)(Multiple) Norm 2

300-350 (rad/sec)	FLC (GA) (Multiple)	FLC (GA) (Multiple) Norm 1	FLC (GA) (Multiple) Norm 2
Wm_peak(rad/sec), Max. Os%	349.9, 0.028%	349.5, 0.14%	349.7, 0.08%
tr (sec.)	0.0019	0.0019	0.0019
Wm_ss(rad/sec)	350	349.6	349.8
ts (sec.)	0.0022	0.0019	0.0020
Final Wm_ss(rad/sec), Max. Os%	350, 0%	349.6, 0.11%	349.9, 0.03%

300-350 FLC (GA)(Multiple), FLC (GA)(Multiple) Norm 1, FLC (GA)(Multiple) Norm 2

As seen from the result, there is not much change compared to previous optimization runs. But when the cost function is normalized overshoot values tend to become slightly negative as reference angular velocity values are never maintained with a very small steady-state error value. These controllers seem to have similar performance in total. But one should not forget that the controllers developed due to normalization are obtained by less computational effort compared the controllers obtained in previous sections as number of chromosomes and number of populations are decreased compared to GA optimization phases at the previous chapters.

CHAPTER 7

CONCLUSION

In this thesis, the performance of the controllers designed by GA based on a multi-criteria cost function assessing and evaluating the comparative importance of time domain performance criteria of a closed loop control system defined for a BLDC motor angular velocity control application are compared with controllers previously mentioned as reference for the same control application. The results are grouped for optimization phase (Case 1) and validation phase (Case 2) simulations. Single PI Approach, Multiple PI Approach and Multiple FLC Approach are employed to develop controller structures by GA and these controllers are compared with the previously obtained controller structures in [14] and advantages and disadvantages are of these controllers are mentioned as the outcome of comparison process. Later the performance indices are normalized and effect of these normalizations in the optimization phase is monitored in Chapter 6.

REFERENCES

1. **Kumar J.S., Joice S.R., (2011)**, *“Practical Implementation of Four Quadrant Operation of Three Phase Brushless DC Motor using dsPIC”*, pp.91-94.
2. **Krishnan R., Beutler A.J., (1985)**, *“Performance and Design of An Axial Field Permanent Magnet Synchronous Motor Servo Drive”*, in Proc. IEEE IAS Annu. Meeting, pp. 634-640.
3. **Mazenc M., Villanueva C., Hector J., (1985)**, *“Study and Implementation Of A Hysteresis Controlled Inverter On A Permanent Magnet Synchronous Machine”*, IEEE Transaction on Industrial Applications, vol. IA-21 no.2, pp408-413.
4. **Hanselman D., (2006)**, *“Brushless Permanent Magnet Motor Design”*, 2nd Edition, Magna Physics Publication, United States of America, pp. 1-226.
5. **Singh A.K., Kumar K., (2002)**, *“Modelling and Simulation of PID Controller Type PMBLDC Motor”*, Proceedings of National Seminar on Infrastructure Development Retrospect and prospects Institution of Engineers (I),(India) , vol. 1, pp. 137-146.
6. **Jahns T. M., (1984)**, *“Torque Production In Permanent-Magnet Synchronous Motor Drives With Rectangular Current Excitation”*, IEEE Trans. Ind. Appl., vol. 20, no. 4, pp. 803-813.
7. **Funabiki S., Himei T., (1985)**, *“Estimation of Torque Pulsation Due To The Behavior Of A Converter And An Inverter In A Brushless Dc-Drive System”*, Proc. Inst. Elec. Eng., vol. 132, no. 4, pp. 215-222.

8. **Dwivedi A. , Tiwari A., (2013)**, “*A Review : Speed Control of Brushless DC Motor*”, *IJBSTR*, vol. 1, no. 6, pp. 14–19.
9. **Rambabu S., (2007)**, “*Modeling And Control of A Brushless Dc Motor*”, M.S. Thesis, National Institute of Technology, Rourkela.
10. **Singh C. P., Kulkarni S., Rana S.C., (2013)**, “*Scientists State-Space Based Simulink Modeling of BLDC Motor and its Speed Control using FLC PID Controller*”, *International Journal of Advances in Engineering Science and Technology*, vol. 2 , no. 3, pp.359-369.
11. **Ricketts D. , Kankam M., (2002)**, “*Development And Implementation of An Adaptive FLC-Neural-Network Controller for Brushless Drives*”, *IEEE Industry Applications Society*, USA, vol.38, no.2.
12. **Cunkas M., Aydogdu O., (2010)**, “*Realization Of FLC Logic Controlled Brushless Dc Motor Drives Using Matlab/Simulink*”, *Mathematical And Computational Applications*, vol. 15, no.2, pp. 218-229.
13. **Immaneni H., (2013)**, “*Mathematical Modelling And Position Control Of Brushless Dc (BLDC) Motor*”, *International Journal Of Engineering Research and Applications*, vol.3, no.3, pp. 1050-1057.
14. **Ibrahim R.A., (2015)**, “*Designing Efficient Three Phase Brushless Dc Motor Control Systems*”. M.S. Thesis, Çankaya University, Turkey, vol. 2, pp. 6-19.
15. **Çetin E.,(2018)**,” *Artificial Intelligence Applications*”,vol. 17, pp.435-436, vol. 4, pp. 440-441
16. **From the Website of MathWorks**,
“<https://www.mathworks.com/help/control/ref/stepinfo.html>”.

APPENDICES A

CURRICULUM VITAE

PERSONAL INFORMATION

Surname, Name: SEZİK Nurullah

Date and Place of Birth: 21 Sep. 1981, ERZURUM

Email: nsezik@gmail.com

EDUCATION

Degree	Institution	Year of Graduation
M.Sc.	Çankaya University, Mechatronics Engineering, Ankara	2020
B.Sc.	Near East University Electric and Electronic Engineering, Nicosia	2006
High School	Yenimahalle Anatolian Vocational High School, Ankara	1999

FOREIGN LANGUAGES

English