

KADIR HAS UNIVERSITY  
GRADUATE SCHOOL OF SCIENCE AND ENGINEERING



COMPUTATION OF TWO-VARIABLE MIXED ELEMENT NETWORK  
FUNCTIONS

NAUMAN TABASSUM

ISTANBUL, JUNE 2018





Nauman Tabassum

(M.S) Thesis

June 2018

# COMPUTATION OF TWO-VARIABLE MIXED ELEMENT NETWORK FUNCTIONS



NAUMAN TABASSUM

Submitted to the Graduate School of Engineering  
In partial fulfillment of the requirements for the degree of  
Master of Science  
In  
Electronics Engineering

KADIR HAS UNIVERSITY  
ISTANBUL, JUNE 2018

## DECLARATION OF RESEARCH ETHICS / METHODS OF DISSEMINATION

I, NAUMAN TABASSUM, hereby declare that;

- This Master's Thesis is my own original work and that due references have been appropriately provided on all supporting literature and resources.
- This Masters's Thesis contains no material that has been submitted or accepted for a degree or diploma in any educational institution.
- I have followed the "Kadir Has University Academic Ethics Principles" prepared in accordance with the "The Council of Higher Education's Ethical Principles".

In addition, I understand that any false claim in respect to this work will result in disciplinary action in accordance with University regulations.

Furthermore, both printed and electronic copies of my work will be kept in Kadir Has Information Center under the following condition as indicated below;

- The full content of my thesis will be accessible from everywhere by all means.

NAUMAN TABASSUM



Date: 08/06/2018

KADIR HAS UNIVERSITY  
GRADUATE SCHOOL OF SCIENCE AND ENGINEERING

**ACCEPTANCE AND APPROVAL**

This work entitled **COMPUTATION OF TWO-VARIABLE MIXED ELEMENT NETWORK FUNCTIONS** prepared by **NAUMAN TABASSUM** has been judged to be successful at the defense exam held on **JUNE 8, 2018** and accepted by our jury as **MSc THESIS**.

APPROVED BY:

Asst. Prof. Dr. Atilla ÖZMEN (Kadir Has University, Istanbul.)  
(Thesis Supervisor)

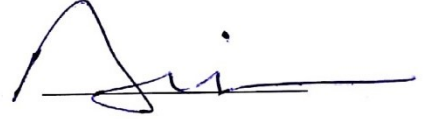

Assoc. Prof. Dr. Metin ŞENGÜL (Kadir Has University, Istanbul.)  
(Thesis Co-supervisor)

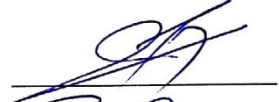

Assoc. Prof. Dr. Yasin ÖZÇELEP (Istanbul University, Cerrahpaşa.)



Asst. Prof. Dr. Baran TANDER (Kadir Has University, Istanbul.)

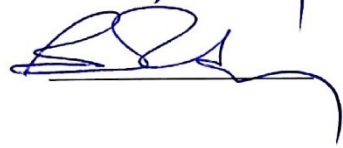

I certify that the above signatures belong to the faculty members named above.

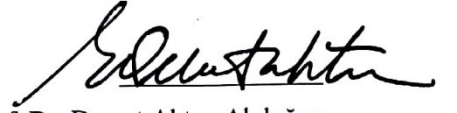

Assoc. Prof. Dr. Demet Akten Akdoğan

Dean of Graduate School of Science and Engineering

DATE OF APPROVAL: ( 8/06/2018)

# Table of Contents

<b>Table of Contents.....</b>	<b>ii</b>
<b>List of Figures .....</b>	<b>iv</b>
<b>Abstract .....</b>	<b>v</b>
<b>Özet.....</b>	<b>vi</b>
<b>Aknowledgements.....</b>	<b>vii</b>
<b>Dedication.....</b>	<b>ix</b>
<b>1 INTRODUCTION .....</b>	<b>1</b>
1.1 Overview .....	1
1.2 Literature Review .....	1
1.3 Thesis Contribution .....	4
1.4 Thesis Outline .....	4
<b>2 FUNDAMENTAL PROPERTIES OF LOSSLESS TWO-PORT NETWORKS .....</b>	<b>6</b>
2.1 Port, Two-Port and n-Port Network .....	6
2.2 Scattering Representation of Two-port Networks .....	7
2.3 Scattering Transfer Representation of Two-Ports .....	14
2.4 Canonic Representation of Scattering and Scattering Transfer Matrix .....	15
2.5 Distributed Networks with Commensurate lines.....	17
2.6 Network Composed of Mixed Elements (Lumped and Distributed).....	20
<b>3 A SEMI-ANALYTIC PROCEDURE FOR DESCRIBING LOSSLESS TWO-PORT MIXED (LUMPED AND DISTRIBUTED ELEMENT) NETWORKS.....</b>	<b>22</b>
3.1 Two Variable Characterization of Cascaded Mixed Elements (Lumped and Distributed) Two-port Networks .....	22
3.1.1 Basic Definitions and Properties .....	24
3.1.2 Cascaded Lumped-Distributed Two-Port Networks .....	29
3.2 Construction of Two-variable Network for Cascaded Designs.....	36
3.2.1 Factorization of Two-Variable Polynomials .....	36
3.2.2 Construction of Low-Pass Ladders with Unit Elements(UEs).....	42

<b>4 PROPOSED APPROACH TO FIND ANALYTICAL SOLUTION FOR LPLU OF DEGREE FIVE .....</b>	<b>61</b>
4.1 Problem Statement: .....	61
4.2 Explicit Solution for LPLU of Degree Five: .....	61
4.2.1 Case-I (Three Lumped and Two Distributed ( $np = 3, n\lambda = 2$ )) .....	61
4.2.2 Case-II (Three Distributed and Two Lumped ( $n\lambda = 3, np = 2$ )) .....	64
<b>5 CONCLUSION AND REMARKS .....</b>	<b>72</b>
5.1 Standard Decomposition Technique to Solve Fundamental Equation Set Representing a General Lossless Mixed Two-port Network Cascade .....	72
5.2 Standard Decomposition Algorithm to Build a General Lossless Mixed Two-port Network Cascade.....	73
5.3 Remarks.....	76
<b>6 MATLAB CODE .....</b>	<b>77</b>
6.1 Case-I (Three Lumped and Two Distributed ( $np = 3, n\lambda = 2$ )) .....	77
6.2 Case-I (Three Lumped and Two Distributed ( $np = 2, n\lambda = 3$ )) .....	81
<b>References .....</b>	<b>86</b>
<b>CURRICULUM VITAE .....</b>	<b>89</b>



## List of Figures

<b>Figure 1.1</b> Lossless Two-port Darlington equivalent Network (Darlington, 1939).....	3
<b>Figure 2.1</b> General two-port network (four-terminal network).....	6
<b>Figure 2.2</b> Doubly terminated two-port network (Medely, 1993).....	7
<b>Figure 2.3</b> Representation of transmission line unit elements and their counterparts in Richards transformation (ŞENGÜL, 2006).....	19
<b>Figure 2.4</b> Application of Richards theorem.....	20
<b>Figure 3.1</b> Simple Lumped Section.....	24
<b>Figure 3.2</b> Simple Distributed Section.....	27
<b>Figure 3.3</b> a) Cascaded Distributed Design and Lossless Lumped Ladder. b) Cascaded Decomposition. c) Cascade of Simple Lumped and Distributed Section.....	34
<b>Figure 3.4</b> Low-pass Ladder with Unit Elements.....	42
<b>Figure 3.5</b> LPLU Section of Degree Two.....	46
<b>Figure 3.6</b> LPLU Section of Degree Three.....	48
<b>Figure 3.7</b> LPLU Section of Degree Four.....	52
<b>Figure 3.8</b> LPLU Section of Degree Five.....	56
<b>Figure 3.9</b> Higher Order LPLUs as Cascades of Elementary LPLU Section.....	60
<b>Figure 4.1</b> Physical Realization of LPLU Section of Degree Five ( $np = 3, n\lambda = 2$ ).....	64
<b>Figure 4.2</b> Example N0.1 Physical Realization of LPLU Section of Degree Five ( $np = 2,$ $n\lambda = 3$ ).....	69
<b>Figure 4.3</b> Example No.2 Physical Realization of LPLU Section of Degree Five ( $np = 2,$ $n\lambda = 3$ ).....	71

## COMPUTATION OF TWO-VARIABLE MIXED ELEMENT NETWORK FUNCTIONS

### Abstract

In this dissertation, the algorithm known as “*Standard Decomposition Technique (SDT)*” is used together with Belevitch’s canonic representation of scattering polynomial for two-port networks operate on high frequency, to find the analytical solutions for “*Fundamental equation set (FES)*”. This FES is extracted by using Belevitch canonic polynomials “ $g(p, \lambda)$ ,  $h(p, \lambda)$  and  $f(p, \lambda)$ ” used for the description of mixed lumped and distributed lossless two-port cascaded networks in two variables of degree five and the obtained solutions are further used to synthesis the realizable networks. The solution to the problem is also classified into two cases, first case is discussed for three lumped and two distributed ( $n_p = 3, n_\lambda = 2$ ) and the second is for three distributed and two lumped important ( $n_p = 2, n_\lambda = 3$ ) the solution for both these cases are expressed separately with conclusive examples.

**Keywords:** Standard Decomposition Technique (SDT), Belevitch’s canonic representation, scattering polynomials, Two-port networks, Fundamental equation set (FES), Mixed lumped and distributed lossless networks, Cascaded networks in two variables, Networks of degree five.

## İKİ DEĞİŞKENLİ KARIŞIK ELEMENLİ DEVRE FONKSİYONLARININ HESABI

### Özet

Bu tezde, Standart Ayırıştırma Tekniği (SDT) olarak bilinen algoritma, yüksek frekansta çalışan iki portlu ağlar için Belevitch'in saçılma polinomunun kanonik gösterimi ile birlikte, Temel Denklem Seti (FES) için analitik çözümler bulmak amacıyla kullanılmıştır. Bu denklem seti, Belevitch'in iki değişkenli karışık toplu ve dağıtılmış kayıpsız iki portlu kaskad ağların tanımı için kullanılan  $g(p, \lambda)$ ,  $h(p, \lambda)$  ve  $f(p, \lambda)$  kanonik polinomlarından elde edilmiş ve elde edilen sonuçlar daha sonra gerçekleştirilebilir devrelerin sentezinde kullanılmıştır. Problem üç toplu ve iki dağıtılmış ( $n_p = 3, n_\lambda = 2$ ) ile iki toplu ve üç dağıtılmış ( $n_p = 2, n_\lambda = 3$ ) eleman olacak şekilde iki ayrı durum için ele alınmış ve çözüm her bir durum için ayrı ayrı verilmiştir.

**Anahtar Kelimeler:** Standart Ayırıştırma Tekniği (SDT), Belevitch'in kanonik gösterimi, Saçılma polinomları, İki portlu ağlar, Temel denklem seti (FES), Karışık lumped ve dağıtık kayıpsız ağlar, İki değişkenli basamaklı ağlar, Beşinci dereceden ağlar.

## Acknowledgements

In the name of Allah, the most Gracious, the most Merciful and the most Beneficent. I am thankful to Almighty Allah for giving me strength and blessed me with all kind of needs to complete my thesis. I would love to offer my heartiest praises to the Prophet Muhammad (ﷺ), the Mightiest and final Prophet of Almighty Allah, has been sent as the best of teachers to humankind, to teach humanity and to live a purposeful life.

Special appreciation goes to Dr. Atilla ÖZMEN, who is not just my thesis advisor but also a nice and kind human being in all aspects of life. I am thankful, from the depth of my heart for his through supervision, continuous support and precious pieces of advice, without his efforts, this dissertation would not even be anywhere near to possible. I believe he put his best to make my efforts into a success. It is only because of his insight, enthusiasm and continuous encouragement which helped me to complete this task. I would also like to thank and appreciate Dr. Metin ŞENGÜL, co-advisor to my work, for the guidelines and ideas. I found him one of the best in the field, I have learned a lot from his work and his research was a great help to complete my thesis. This was an honor and great learning experience to work with both of these personalities.

I express my deepest gratitude to all the faculty member of Department of Electrical and Electronics Engineering and Graduate School of Science and Engineering, especially Dr. Ayşe Hümeyra BİLGE, Dr. Funda SAMANLIOĞLU, DR. Hakan Ali ÇIRPAN, Dr. Arif Selçuk ÖĞRENCİ and Dr. Serhat ERKÜÇÜK.

I would also like to thank my parents, Mr. Ghulam Farid and Mrs. Shafqat Bibi, because without them I am nothing, both of them are very important part of my life and a driving force for me to find positive ways for existence and to achieve goals. They are the reason behind all of my success and learnings. I am grateful for all of their support and prays that made me finish this degree with success. My parents are my mantors. I would like to thank my brothers and sisters Mr. Adnan Farid, Miss. Ayesha Farid, Miss. Aqsa Farid, Mr. Muhammad Usman Farid, and Mr. Muhammad Ateeq-ur- Rehman for having belief in me and showing their presence at the time of need and making my family the best family and keeping my home a sweet home.

Finally, I would like to thank some of my Turkish friends, Mr. Hakan TURAN, Miss. Zozan KARAKAŞ, my brother Mr. Yasin KOÇ and a great family of Mr. Serdar CELEBCI his wife Miss Perveen and their small daughter Maya for their great love and hospitality. I would like to thank my friends especially Mr. Waqas Khan Abbasi, Mr. Abdul Mohemine, Mr. Mohsin Kiani and Miss. Zoya Javaid for supporting me and giving me the best of advice. There are lots of name of friends and relative I want to count but cannot point them all, so compositely I am thankful to all for being a beautiful part of my life.

I am completing the segment of the novel with this prayer.

رَبِّ اشْرَحْ لِي صَدْرِي وَيَسِّرْ لِي أَمْرِي وَاخْلُلْ عُقْدَةً مِنْ لِسَانِي يَفْقَهُوا قَوْلِي (القرآن)

O my Lord! Open for me my chest (grant me self-confidence, contentment, and boldness); Ease my task for me; And remove the impediment from my speech, so they may understand what I say (Al-Quran)

**Nauman Tabassum**

## Dedication

وَبِالْوَالِدَيْنِ إِحْسَانًا (القرآن)

And treat you parents with kindness (Al-Quran)

To my parents.





# 1 INTRODUCTION

## 1.1 Overview

In the field of communication systems design and development, one of the most crucial problems is to design a coupling circuit model, that work over a broadest attainable frequency band to achieve optimum performance. A coupling circuit is used to match one device to another, also known as impedance matching network or equalizer network. Characteristically, the problem here is to design an impedance matching network, to convert a provided impedance to a particular one, the phenomenon usually referred to as equalization or impedance matching. The problem of designing, matching networks was considered seriously in literature for several decades. The development of millimeter-wave and microwave integrated circuit technology motivated new ventures in the design and development of wideband communication systems and also stimulated a renewed interest in broadband matching.

High-frequency telecommunication systems such as satellites, antennas, amplifiers, filter and high-frequency transistors contain front-end, inter-stage, and back-end blocks and these blocks can be distinguished and classified by their measured data. For these type of high-frequency systems, to control the power flow between above-described stages, filters and equalizer circuits are designed by using recognized analytical and semi-analytical techniques. Modeling of numerically explained components is mandatory, either by practicable circuit functions or components. From this discussion, aim is to develop ability to model numerically define device by mean of lossless components by using recent analytic design methods (ŞENGÜL, 2006).

## 1.2 Literature Review

It is contemplated that the broadband matching theory is originated after the development of restricted load impedance gain-bandwidth theory and restricted load impedance is composed of a parallel combination of a resistor and a capacitor (Bode, 1945). After more developments, a generalized gain-bandwidth theory is presented for any random load impedance (Fano, 1950) (Youla, 1964). Circuit modeling is critically important to design broadband matching circuits



(Chen, 1988). The requirement is to develop an optimum lossless two-port matching network (Carlin & Amstutz, 1981) that is able to transfer maximum power between load and source at broadest possible frequency band (Aksen, 1994). Here, source and load can be represented by numerical data and can also be considered as complex one port networks (ŞENGÜL, 2006) (Yarman, 1982). To implement the Analytical Gain-Band Width Theory (Carlin, 1977) (Belevitch, 1968) it is necessary to understand basic of complex one port networks. Later on, to encounter the broadband matching problems many other researchers had published extended works with better elaboration. While working with complex practical application and designing complicated matching circuits, the current broadband matching theory faces serious problems. Therefore, plenty of literature is available that focused on finding more practical ways to design matching networks.

Precious work is available in the literature about data modeling (Smilen, 1964) (Baum, 1948) is available but semi-analytic computer-aided and numerical techniques are practiced because of difficulties and presence of inaccuracy in existing methods of modeling the matching problems (Kody & Stoer, 1972) (Kotiveeriah, 1972). Carlin (Carlin, 1977) and Yarman (Carlin & Yarman, 1983) proposed Real Frequency Technique (RFT), further advancements are made by several researchers to encounter the difficulties of modeling the matching problems. These latest and efficient and accurate modeling and matching with help of analytic methods are still unable to answer all fundamental problems for researchers (Yarman, 1982) (Yarman, 1982) (Beccari, 1984) (Yarman & Aksen, 1992). To full the industrial requirements like microwave amplifier design problems and equalizer circuit design problems several computer programs have been developed (Hatley, 1967). Although these circuit design computer programs are very helpful for several practical problems but still insufficient to encounter all kinds of complicated design problem, as their working principle is Brute Force method (Yarman & Fettweis, 1990) (Fettweis & Pandel, 1987) (Yarman, 1985) (Carlin & Civalleri, 1985).

It is a normal practice to define the load is by reflection parameters calculated in the desired frequency bandwidth or by amplitude and phase or real and imaginary pairs. While modeling such types of numerical data, the circuit functions realizability conditions and constraints must be considered. Here, a numerical defined physical device as a lossless two-port network (Darlington equivalent) (Darlington, 1939).

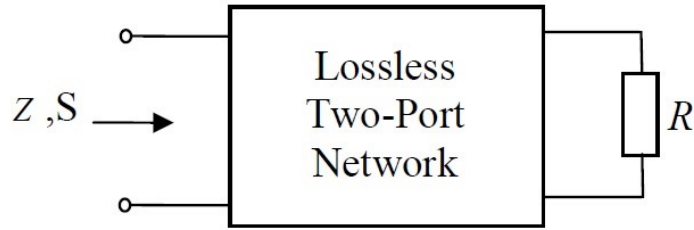

**Figure 1.1 Lossless Two-port Darlington equivalent Network (Darlington, 1939).**

In literature, to model, the impedance data two most widely used methods are:

1. Select a network topology and designate the best appropriate values of components.
2. Determination of impedance or reflection function which is suitable for the data and synthesizes the function to obtain the model.

In the first method, an optimization tool is applied, after choosing the network topology, to define the suitable values to component. Although this is a very easy and uncomplicated method, it carries some difficulties: The process of optimization is highly nonlinear with respect to the values of component, can achieve a local minimum or can diverge from it. The satisfactory result can be achieved after the optimization process, by a proper and careful choice of initial values and it is a very hard task to find suitable initial values (Yarman, 1991).

There is an additional obstacle, there is no explicit answer to, what is the suitable network topology for the provided data? Hence, the modeler will try several network topologies to select the best suitable or the problem will be unsolved.

Several data modeling methods are proposed to model the provided impedance or reflection data. In the easiest one, rational functions are used to depict impedance data and by using interpolation, to estimate the coefficients of the function. A similar rational function  $Z(p)$  is given in 1.1;

$$Z(p) = \frac{\sum_{j=0}^{n-1} \alpha_j p^j}{\sum_{j=0}^{n-1} \beta_j p^j} \quad j = 0, 1, \dots, (n-1) \quad (1.1)$$

where, complex frequency variable  $p = \sigma + i\omega$  and  $\alpha_j$  and  $\beta_j$  are positive real coefficients. But, positive real function cannot be obtained at the end of this technique. Two other modeling tools are proposed, and these methods are based on working with scattering parameters or input impedance of the device. The first method, named as Immittance Approach, impedance or admittance values are used. Approximation of real part of the input impedance is calculated by using a minimum reactance function, then minimum reactive data is removed after this Foster function is used to model the remaining imaginary data. In the second method, reflection coefficient data is modeled by a bounded function and the method is called Reflection Parameter Approach.

### 1.3 Thesis Contribution

In the available literature two port networks of degree five consist of mixed lumped and distributed elements, the transfer function and canonic representation are not represented on pure analytical basis. In simple words, there is no analytical solution for LPLU of degree five exist in literature. So, in this study, the objective is to use a modeling method named “*Standard Decomposition Technique*” and focus will be on the network consist of the cascade of mixed lumped and distributed elements of degree five to find analytical solution to the problem.

### 1.4 Thesis Outline

Chapter 1 of the thesis is an introductory novel to the topic and its brief overview, it is also covering the previous research in the related field with the contribution of this dissertation.

Chapter 2 is covering the fundamental concepts of network theory, those are related and helpful for further study. The chapter contains a brief introduction of lossless two-port networks, scattering representation, canonic representation of scattering matrix and mixed, lumped and distributed elements.

In chapter 3 our focus will be on the description of mixed lumped and distributed elements, the issues involving in the fabrication of two-variable network function are also discussed. A semi-analytical technique is presented to elaborate two-port cascaded mixed networks.

In chapter 4 the focus is to find the analytical solutions for LPLU of degree five for some real and realizable values. A two-variable polynomial with degree five is generated LPLU of degree

five, first the discussion is made for three lumped and two distributed ( $n_p = 3, n_\lambda = 2$ ) and the second will be with three distributed and two lumped important ( $n_p = 3, n_\lambda = 2$ ).

Chapter 5 is concluding the discussion and developing the remarks, at the end some important Matlab code are given, used to develop the solutions.



## 2 FUNDAMENTAL PROPERTIES OF LOSSLESS TWO-PORT NETWORKS

This chapter is dedicated to investigating and discuss the basic ideas related to network theory. A review of basic definition and elementary properties regarding the scattering parameters description of lossless two-port networks has made. Fundamental properties of the network functions related to lossless two-port lumped and distributed networks are elaborated. A brief introduction of mixed lumped and distributed elements network is also discussed.

### 2.1 Port, Two-Port and n-Port Network

In network theory, a pair of terminals joining an electrical network or a circuit to another external circuit is known as a port and the current entering through one terminal is always equal to the current leaving through the other terminal of a port. These terminals are also called nodes. Circuit components like capacitors, resistors, inductors, transistors etc., may have two or more terminals. The combination of these components in a meaningful manner form networks. Figure 2.1 is representing a two-port lossless network a kind of quadripole network consist of two ports or four terminals also representing the values of voltages and current on each terminal. Generally, mathematical representation obtained from the values of currents and voltages of external terminals are used to determine the source and load response connected to the network.

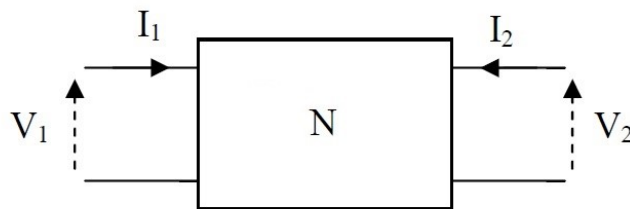

**Figure 2.1 General two-port network (four-terminal network).**

## 2.2 Scattering Representation of Two-port Networks

It is a fact that impedance, admittance and transmission parameters are widely used to calculate the terminal response of a two-port lossless network and they also work quite beautifully. Impedance and admittance parameters are determined with respect to infinite or zero loads at the ports although they conclude a useful information about two-port networks. There is no assurance of equally well results for all type two-port networks because of the requirement of infinite or zero loads at the ports. On contrary, scattering parameters are well defined with respect to finite loads and also exist for all kinds of networks. It is well established that scattering parameters are used as a powerful tool to understand the power transfer characteristics of networks like filter and matching networks especially at microwave frequencies, under specific terminations.

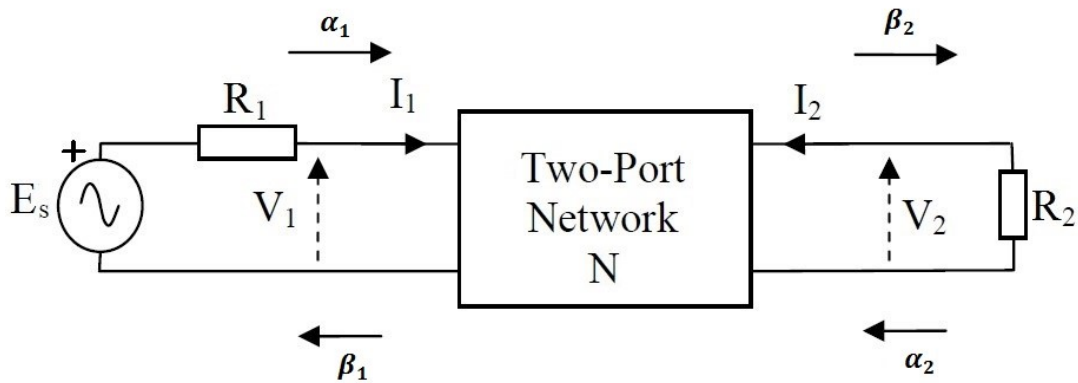

**Figure 2.2 Doubly terminated two-port network (Medely, 1993)**

Figure 2.2 is referring to a two-port network which is excited at port 1 by a voltage source  $E_s$ , through impedance  $R_1$ , and terminated at port 2 by load impedance  $R_2$ .  $R_1$  and  $R_2$ , can be of any value because they are just reference impedances, although  $50\Omega$  is the most commonly used value. Figure 2.2 is explaining the definitions of current  $I_j$ , voltage  $V_j$  and impedance  $R_j$  and also, two new parameters  $\alpha_j$  and  $\beta_j$  can also be defined as (Medely, 1993).

$$\alpha_j = \frac{V_j + R_j I_j}{2\sqrt{|ReR_j|}} \quad (2.1)$$

and

$$\beta_j = \frac{V_j - R_j^* I_j}{2\sqrt{|ReR_j|}} \quad (2.2)$$

by solving 2.1 and 2.2, the results are

$$V_j = (\alpha_j + \beta_j)\sqrt{Re|R_j|} \quad (2.3)$$

and

$$I_j = \frac{(\alpha_j - \beta_j)}{\sqrt{Re|R_j|}} \quad (2.4)$$

here  $R_j^*$  and  $Re|R_j|$  is the complex conjugate and real part of reference Impedance  $R_j$  respectively. Equations for scattering parameters for two-port in Figure 2.2 can be defined as (Medely, 1993).

$$\beta_1 = S_{11}\alpha_1 + S_{12}\alpha_2 \quad (2.5)$$

$$\beta_2 = S_{21}\alpha_1 + S_{22}\alpha_2 \quad (2.6)$$

Expression for scattering parameter in matrix form any n-port network is

$$\boldsymbol{\beta} = \mathbf{S}\boldsymbol{\alpha} \quad (2.7)$$

The evaluation of coefficients of 2.5 and 2.6 can be estimated by placing  $\alpha_1 = 0$  and  $\alpha_2 = 0$ . Now consider the Figure 2.2, the output voltage is  $-I_2 R_2$  and substituting this value in 2.1 the result is;

$$\alpha_2 = \frac{-V_2 R_2 + V_2 R_2}{2\sqrt{|ReR_2|}} = 0 \quad (2.8)$$

If any of the ports is not connected to the source and having reference impedance on termination that specific  $\alpha_j$  is always zero. Transmission line theory (Medely, 1993) the expression can be written as,

$$V_j = v_{ji} + v_{jr} \quad (2.9)$$

and,

$$I_j = \frac{v_{ji} - v_{jr}}{R_j} \quad (2.10)$$

here the subscripted  $i$  and  $r$  are representing the incident component and reflected component of voltage, respectively. Considering  $R_j$  to be real and substituting in 2.1

$$\alpha_j = \frac{(v_{ji} + v_{jr}) + R_j \left( \frac{v_{ji} - v_{jr}}{R_j} \right)}{2\sqrt{|ReR_j|}} = \frac{v_{ji}}{\sqrt{|ReR_j|}} \quad (2.11)$$

and from 2.2,

$$\beta_j = \frac{(v_{ji} + v_{jr}) - R_j^* \left( \frac{v_{ji} - v_{jr}}{R_j} \right)}{2\sqrt{|ReR_j|}} = \frac{v_{jr}}{\sqrt{|ReR_j|}} \quad (2.12)$$

It can be seen in 2.11 that  $\alpha_j$  is the function of incident voltage and  $\beta_j$  is a function of reflected voltage by 2.12. It can also be observed that the squares of  $\alpha_j$  and  $\beta_j$  gives us the dimensions of power. Mathematically;

$$|\alpha_j|^2 = \frac{|v_{ji}|^2}{|ReR_j|} \quad \text{and} \quad |\beta_j|^2 = \frac{|v_{jr}|^2}{|ReR_j|} \quad (2.13)$$

So,  $\alpha_j$  and  $\beta_j$  are representing incident and reflected waves respectively, also  $|\alpha_j|^2$  and  $|\beta_j|^2$  are representing incident and reflected powers respectively. From 2.5 and 2.6, it can be observed that the reflected wave from any port is equal to the submission of modified incident waves from all the ports, this modification is made by S-parameter matrix.



Mathematically,  $|\alpha_j|^2$  can be represented by Figure 2.2,

$$|\alpha_1|^2 = \left| \frac{V_1 + R_1 \left( \frac{E_s - V_1}{R_1} \right)}{2\sqrt{\text{Re}R_1}} \right|^2 = \frac{|E_s|^2}{4|\text{Re}R_1|} \quad (2.14)$$

From 2.14 it can be observed that  $|\alpha_1|^2$  is total power available from the source, by subtracting reflected power from total available power, power delivered to the network can be obtained, that is represented as,

$$|\alpha_j|^2 - |\beta_j|^2 = \alpha_j \alpha_j^* - \beta_j \beta_j^* \quad (2.15)$$

$$\begin{aligned} &= \frac{(V_1 + R_1 I_1)(V_1^* + R_1^* I_1^*)}{4|\text{Re}R_1|} - \frac{(V_1 - R_1 I_1)(V_1^* - R_1^* I_1^*)}{4|\text{Re}R_1|} \\ &= \frac{2R_1(V_1 I_1^* + V_1^* I_1)}{4|\text{Re}R_1|} \\ &= \frac{R_1}{|\text{Re}R_1|} \text{Re}(V_1 I_1^*) \end{aligned} \quad (2.16)$$

If the source is terminating port 1, then  $|\alpha_j|^2$  will be zero and  $|\beta_j|^2$  can be expressed as,

$$|\beta_2|^2 = \left| \frac{V_2 - R_2^* I_2}{2\sqrt{\text{Re}R_2}} \right|^2 = |\text{Re}R_2| |I_2|^2 \quad (2.17)$$

where 2.17 is representing the delivered load power.

Coefficients  $S_{mn}$  of S-parameter matrix are representing the ratios between reflected and incident waves, is most appropriate depiction of microwave circuits. When a source with available power  $|\alpha_j|^2$  is attached to port  $j$ , value of  $\alpha$  for port  $j$  and value of  $\beta$  for all ports can be calculated.

At port  $j$ ,  $S_{jj}$  will be,

$$S_{jj} = \frac{\beta_j}{\alpha_j} = \frac{V_j - R_j^* I_j}{V_j + R_j I_j} = \frac{\Omega_{in} I_j - R_j^* I_j}{\Omega_{in} I_j + R_j I_j} = \frac{\Omega_{in} - R_j^*}{\Omega_{in} + R_j} \quad (2.18)$$

in 2.18,  $\Omega_{in}$  is representing the input impedance of port  $j$ . The reflection coefficient of port  $j$  will be  $\rho_{in}$  and is equal to  $S_{jj}$ , power loss at port  $j$  can be given by,

$$|S_{jj}|^2 = \frac{|\beta_j|^2}{|\alpha_j|^2} = \frac{\text{Reflected power from input port}}{\text{Availale power at source to port}} \quad (2.19)$$

at any other port  $k$  and  $j \neq k$ , transducer power gain can be given as,

$$|S_{kj}|^2 = \frac{|\beta_k|^2}{|\alpha_j|^2} = \frac{\text{Power delivered to the load}}{\text{Availale power at source to port}} \quad (2.20)$$

By the law of conservation of energy, the total incident power at all the ports of a passive network system must be equal to the power dissipated by in the network and power reflected from the network. The dissipated power by the network can be calculated by subtracting the reflected power from incident power as  $|\alpha_j|^2 - |\beta_j|^2$ . The total dissipated power  $P_\Delta$  can be given as the summation of the dissipated powers at every port of the network (Medely, 1993).

$$P_\Delta = \sum_{j=1}^m (|\alpha_j|^2 - |\beta_j|^2) = \sum_{j=1}^m \alpha_j \alpha_j^* - \sum_{j=1}^m \beta_j \beta_j^* \quad (2.21)$$

or,

$$P_\Delta = [\alpha^*]^t \alpha - [\beta^*]^t \beta \quad (2.22)$$

here  $[\alpha^*]^t$  and  $[\beta^*]^t$  are representing the transpose of complex conjugate of each element of  $\alpha$  and  $\beta$ . By 2.7,

$$[\beta^*]^t = [S^*]^t [\alpha^*]^t \quad (2.23)$$

substituting 2.23 in 2.22,

$$P_\Delta = [\alpha^*]^t \alpha - [S^*]^t [\alpha^*]^t S \alpha \quad (2.24)$$

after simplifying,

$$P_{\Delta} = [\alpha^*]^t \{I - [S^*]^t S\} \alpha \quad (2.25)$$

the term in curly braces of 2.25 determines whether the dissipated power is positive or negative. The definition can be given as (Medely, 1993).

$$W = I - [S^*]^t S \quad (2.26)$$

The expression in 2.26 is showing the dissipation matrix and if  $W$  is nonnegative quantity the behavior of network will be passive means the dissipated power is zero or greater than zero.

For two-port passive networks,

$$|S_{11}|^2 + |S_{21}|^2 \leq 1 \quad \text{and} \quad |S_{22}|^2 + |S_{12}|^2 \leq 1 \quad (2.27)$$

For two-ports lossless networks the power dissipation will be zero and the expression in 2.26 will become,

$$I = [S^*]^t S \quad (2.28)$$

or in matrix form,

$$\begin{bmatrix} 1 & 0 \\ 0 & 1 \end{bmatrix} = \begin{bmatrix} S_{11}^* & S_{21}^* \\ S_{12}^* & S_{22}^* \end{bmatrix} \begin{bmatrix} S_{11} & S_{12} \\ S_{21} & S_{22} \end{bmatrix} \quad (2.29)$$

and the can also be

$$S_{11}^* S_{11} + S_{21}^* S_{21} = 1 \quad (2.30)$$

$$S_{11}^* S_{12} + S_{21}^* S_{22} = 0 \quad (2.31)$$

$$S_{12}^* S_{11} + S_{22}^* S_{21} = 1 \quad (2.32)$$

$$S_{12}^* S_{12} + S_{22}^* S_{22} = 0 \quad (2.33)$$

by solving 2.30, 2.31, 2.32 and 2.33 the expression will be,

$$S_{11}^* S_{11} = S_{22}^* S_{22} \quad \text{and} \quad S_{12}^* S_{12} = S_{21}^* S_{21} \quad (2.34)$$

The relations derived earlier are concluding that the magnitudes of reflection coefficients and transmission coefficients are bounded by unity, i.e.  $|S_{kj}| \leq 1$  for  $p = i\omega$ .

The discussion earlier can be summarized as following fundamental properties of lossless two-port networks (ŞENGÜL, 2006) (Aksen, 1994).

1. For real  $p$  the elements of matrix  $S$  are real and rational.
2. In  $Re\ p \geq 0$  the matrix  $S$  will be analytic.
3. Matrix  $S$  is paraunitary and satisfies  $[S^*]^\tau S$  for all  $p$ .
4. The lossless two port system will be reciprocal if matrix  $S$  is symmetric, i.e.  $S_{12} = S_{21}$ .

The corresponding impedance and admittance matrices can be easily estimated if the scattering matrix satisfies all the conditions discussed above. The realizability theory based on Darlington approach, in immittance formalism, can be established and expressed by using the driving point functions of a two-port network terminated at the output by a resistance. At this point of discussion, it is relevant to describe the following fundamental properties in correspondence to the driving point impedance and reflectance functions (ŞENGÜL, 2006) (Aksen, 1994).

- The function  $S_1(p)$  will be bounded and real if
  1. For all real  $p$ ,  $S_1(p)$  is real.
  2. In  $Re\ p > 0$  the matrix  $S_1(p)$  is analytic.
  3.  $|S_1(i\omega)| \leq 1, \forall \omega$ .
- The relative input impedance  $R_1(p)$  of a resistively terminated two-port can be given as,

$$R_1(p) = \frac{1 + S_1(p)}{1 - S_1(p)} \quad (2.35)$$

the impedance function 2.35 is positive real function (*p.r.f*) and satisfying the following properties as well,

1. For all real  $p$ ,  $R_1(p)$  is real.
2. for  $Re p > 0$ ,  $Re R_1(p) > 0$ .

The conclusion can be made for a resistively terminated two-port network that the realizability of driving point functions that, "A rational and positive real impedance function (or also be a bounded real reflection/impedance function) can be achieved as a resistively terminated lossless two-port".

### 2.3 Scattering Transfer Representation of Two-Ports

The more appropriate way of dealing with, cascaded two-port networks, is to use the scattering transfer matrix instead of the scattering matrix. Consider 2.5 and 2.6 , rearrange the port variables  $\alpha_j$  and  $\beta_j$ , the result can be expressed as

$$\beta_1 = T_{11}\alpha_2 + T_{12}\beta_2 \quad (2.36)$$

$$\alpha_2 = T_{21}\alpha_2 + T_{22}\beta_2 \quad (2.37)$$

and the matrix representation of 2.36 and 2.37 is,

$$\begin{bmatrix} \beta_1 \\ \alpha_2 \end{bmatrix} = \begin{bmatrix} T_{11} & T_{12} \\ T_{21} & T_{22} \end{bmatrix} \begin{bmatrix} \alpha_2 \\ \beta_2 \end{bmatrix} \quad (2.38)$$

The definition of scattering transfer matrix  $T$  is explained in 2.38, the members of matrix  $S$  are related to the members of matrix  $T$ , as follows,

$$T_{11} = -\frac{\det S}{S_{21}}, T_{21} = -\frac{S_{22}}{S_{21}}, T_{12} = \frac{S_{11}}{S_{21}} \text{ and } T_{22} = \frac{1}{S_{21}} \quad (2.39)$$

In 2.39  $\det S$  is representing the determinant of matrix  $S$ , also the elements of scattering transfer matrix are rational functions, the reciprocity condition for two-port in the case of scattering transfer matrix is  $S_{12} = S_{21}$  that gives to  $\det T = 1$ .

## 2.4 Canonic Representation of Scattering and Scattering Transfer Matrix

Scattering parameters of a two-port can also be represented in term of compact three canonic polynomials. The Belevitch canonic representation of scattering matrix and scattering transfer matrix can be given as (Belevitch, 1968),

$$S = \frac{1}{g} \begin{bmatrix} h & \sigma f_* \\ f & -\sigma h_* \end{bmatrix} \quad \text{and} \quad T = \frac{1}{f} \begin{bmatrix} \sigma g_* & h \\ \sigma h_* & g \end{bmatrix} \quad (2.40)$$

where  $f_* = f(-p)$  is paraconjugate of a real function. The properties of canonic polynomial  $f, g$ , and  $h$  are given as (Aksen, 1994) (ŞENGÜL, 2006).

- $f$  is monic, i.e. its leading coefficient is equal to unity.
- $g$  is strictly Hurwitz polynomial.
- $f = f(p), g = g(p)$  and  $h = h(p)$  are real polynomials in complex frequency domain.
- The relation between  $f, g$  and  $h$  is,

$$gg_* = ff_* + hh_* \quad (2.41)$$

- $\sigma$  is constant and its value is  $\pm 1$ .

If the two-port network is reciprocal, then the polynomial  $f$  will be either even or odd in the case of even the  $\sigma = +1$  and if it is odd then  $\sigma = -1$ , so as result,

$$\sigma = \frac{f_*}{f} = \pm 1 \quad (2.42)$$

now the relation expressed in 2.41 can be expressed as

$$gg_* = \sigma f^2 + hh_* \quad (2.43)$$

as  $p = i\omega$ , and from 2.41,

$$|h| \leq |g| \quad \text{and} \quad |h| \leq |f| \quad (2.44)$$

which in turn imply following degree relations,

$$\deg h \leq \deg g \quad \text{and} \quad \deg h \leq \deg f \quad (2.45)$$

the notation *deg* stands for degree of the canonic polynomials, the term  $\deg g - \deg f$  is representing the number of transmission zeros at infinity and the information about the degree of lossless two-port network lies and equal to the degree of polynomial  $g$ .

In the canonic representation, there is a possibility of the presence of common factor of  $g, f$  and  $h$  at same time. Simply, generally it is not necessary that  $g$  is least common divider for scattering polynomial  $S_{kj}$ . For example, consider  $g$  and  $f$  have a common factor, the transfer factor  $S_{21}$  will be irreducible from  $f/g$ , and the same description will old for other terms of  $S$ . As from the mentioned characteristics,  $g$  the common divider is strictly Hurwitz polynomial, so any common factor of the canonic polynomials is also necessarily Hurwitz. Moreover from 2.41, a common factor between any two of three polynomials  $g, h$  and  $f$  must necessarily divide the third polynomial or its paraconjugate.

A brief discussion about transmission zeros will be part, in next lines. The transmission zeros for a two-post lossless network in forward direction are defined by the zeros of  $S_{21}(p)$  and in revers direction by zeros of  $S_{12}(p)$ . Hence, the calculation of total transmission zeros can be estimated by the product of irreducible forms of  $f/g$  and  $f/g_*$ , by using 2.41 result is

$$\frac{ff_*}{g^2} = \frac{gg_* - hh_*}{g^2} \quad (2.46)$$

Note from 2.46 that the cancelation of possible common factors between  $ff_*$  and  $g^2$  may only occur at those zeros of  $g$  which are zeroes of  $h$  or  $h_*$ . Here  $ff_*$  is real even polynomial, therefore its zeros must be located symmetrically with respect to  $i\omega$ -axis, and they are double on this axis. On the other hand, since  $g$  is strictly Hurwitz polynomial, there is no possibility of the existence of any cancelation of  $ff_*$  in the close right half plan(RHP), i.e.  $Re p \geq 0$ . Consequently, the number of finite zeros of transmission in  $Re p \geq 0$  are equal to the degree of  $f$ . The number of transmission zeros at infinity is then determine by the degree difference between  $g$  and  $f$ . Obviously, the total number of transmission zeros in  $Re p \geq 0$  including those at infinity is equal to the degree of  $g$ .

If the two-port lossless network is reciprocal, then by 2.42  $ff_* = \sigma f^2$ , and therefore each distinct finite transmission zero occurs with even multiplicity. If, in addition, all the transmission zeros are located on  $i\omega$ -axis including infinity then because of 2.46 and Hurwitzness of  $g$ , the polynomial  $f$ ,  $g$  and  $h$  have no common factor and two-port is all-pass free.

Now consider the input impedance  $R_1(p)$  of the lossless two-port network  $N$  as shown in Figure 2.2, and its output is terminated by a resistor. Using the bilinear relation between  $R_1$  and  $S_{11}$ , the input impedance can be given as,

$$R_1 = \frac{1 + S_{11}}{1 - S_{11}} = \frac{g + h}{g - h} = \frac{n}{d} \quad (2.47)$$

here polynomial ratio  $\frac{n}{d}$  is an irreducible form in above expression.

## 2.5 Distributed Networks with Commensurate lines

While working with microwave frequencies, there are problems related to the realization of the conventional lumped elements, to resolve these issues the phenomenon of distributed networks made by transmission lines are appointed. the designing of the distributed circuit by using transmission lines is a very well discussed topic in the literature.

While synthesizing a distributive network, most of the approaches are based on utilization of a building block of a unit length of a transmission line and commonly known as the unit element



(UE). The original idea by Richard (Richards, 1948) was, in most of the microwave filters and matching design techniques, homogeneous and finite transmission lines of commensurable length are used as ideal unit elements. Carefully focus that all the lengths of line elements must be multiples of UE lengths. By keeping the idea of distributed networks composed of commensurate lengths of transmission lines transformation in mind one can analyze and synthesize the networks as lumped element networks.

$$\lambda = \tanh p\tau \quad (2.48)$$

where  $\tau$  is representing the delay of transmission line and  $p = \sigma + i\omega$  is complex variable for frequency. Also  $\lambda = \Sigma + i\Omega$  is known as Richards variable. By using this transformation, periodic mapping of  $\lambda$ -plan onto  $p$ -plan is possible. The conclusion is, a distributed network employed of commensurated transmission lines shows periodic frequency response with respect to the original real frequency.

The important thing is to take care about while mapping, right half plan (RHP) and left half plan (LHP)  $p$ -plan directly mapped onto the respective right half plan (RHP) and left half plan (LHP)  $\lambda$ -plan as  $\{Re p > 0 \leftrightarrow Re \lambda > 0\} \{Re p < 0 \leftrightarrow Re \lambda < 0\}$ . As realizability conditions as based on the criteria of RHP, so RHP criteria must kept same in  $\lambda$ -domain.

The transmission lines in  $\lambda$ -domain of Richards transformation, can be treated as inductor if they are short circuited and as of capacitor if they are open circuited, in specific case if the length of transmission line is shorted then quarter of wavelength, as shown in Figure 2.3. So, the driving point impedance function of a network composed of open or short-circuited transmission lines, is real and positive rational function of  $\lambda$ . Eventually, synthesis techniques used for lumped reactance two-port networks can be utilized for the networks built by commensurated transmission lines, In the case of cascaded connected transmission line, it has no lumped counterparts so must be dealt separately. This is the reason that the two-port equivalent network of transmission line in  $\lambda$ -domain is taken as a unite element (UE).

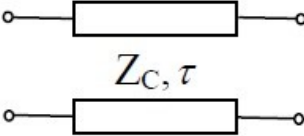
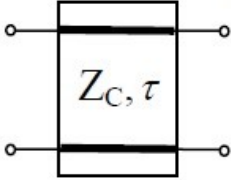
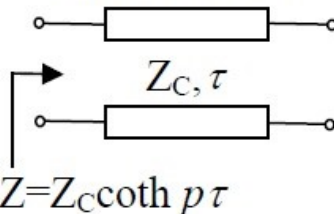
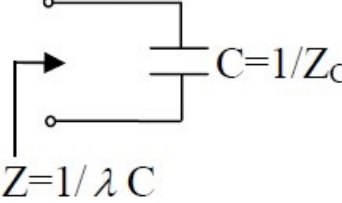
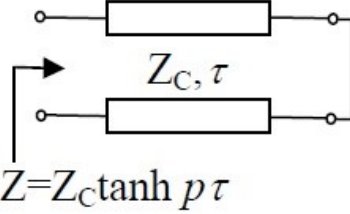
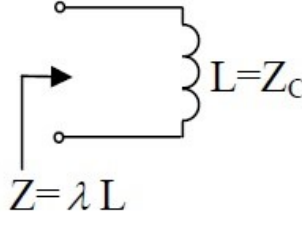
Original frequency domain ( $p$ )	Richards domain ( $\lambda = \tanh p\tau$ )
Transmission Line (TL) 	Unit Element (UE) 
Open ended TL 	$\lambda$ -Capacitor 
Short ended TL 	$\lambda$ -Inductor 

**Figure 2.3 Representation of transmission line unit elements and their counterparts in Richards transformation (ŞENGÜL, 2006).**

The network functions of UEs based networks are clearly are the functions of  $\lambda$ . The input impedance  $Z(\lambda)$  of a unit element terminated network with another impedance  $Z'(\lambda)$  can be expressed as,

$$Z(\lambda) = Z_0 \frac{Z'(\lambda) - \lambda Z_0}{\lambda Z'(\lambda) + Z_0} \quad (2.49)$$

here 2.49 shows that if  $Z'(\lambda)$  is rational then  $Z(\lambda)$  will be rational as well. Conclusion can be give as (ŞENGÜL, 2006) (Aksen, 1994),

- The driving point impedance of a distributed network composed of cascaded UEs is a positive real rational function of  $\lambda$ .

By Richards theorem, UE of characteristic impedance  $Z_0 = Z(1)$  may always be obtained from the positive real impedance function  $Z(\lambda)$  as in 2.49 and the expression became,

$$Z'(\lambda) = Z(1) \frac{Z(\lambda) - \lambda Z(1)}{Z(1) - \lambda Z(\lambda)} \quad (2.50)$$

$Z'(\lambda)$  is also a positive real function with degree not higher than that of  $Z(\lambda)$  in Figure 2.4. Moreover, for  $\lim_{\lambda \rightarrow 1} Z(\lambda) = 0$  in that case the degree of  $Z'(\lambda)$  will be one less than  $Z(\lambda)$ . A very similar expression of the theorem can also be given for the input reflection function (Carlin, 1971).

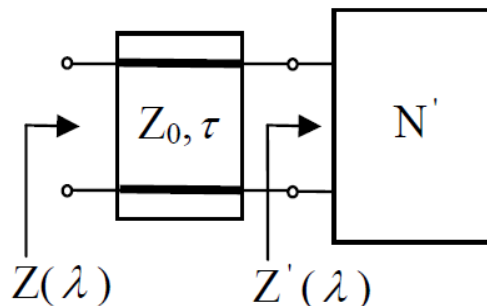

**Figure 2.4 Application of Richards theorem.**

## 2.6 Network Composed of Mixed Elements (Lumped and Distributed)

Working with waves of micro and millimeter frequency range, for circuit realization the use of lumped component only, causes serious implementation difficulties, these problems are physical interconnection of components and parasitic effects. To resolve these problems distributed structures made up of transmission line are used between the lumped element, these transmission lines are also helpful for design problems to improve the performance. A very

useful model can be concluded by the cascaded network of two-port reciprocal networks connected by mean of equal delayed ideal transmission lines.

In literature, designing of mixed lumped and distributed element was very important and has grasped attention for long time but still not able to develop and complete design theory for mixed lumped and distributed elements. Although some concepts of classical network theory have been used to design some types of mixed element two-port networks but not able to do approximation and synthesis of all arbitrary mixed element completely.

In the literature, work and devotion can be observed specifically for the mixed elements networks composed of lumped reactance and uniform ideal transmission lines (lossless and uniform). The idea is, cascaded lossless lumped two-ports connected with ideal transmission lines (UEs) (ŞENGÜL, 2006) (Aksen, 1994).

Matching networks and microwave filters are composed of this kind of cascaded structures. It is so obvious that they have properties of both lumped and distributed networks. These structures also offer advantages over those networks, designed only by transmission lines or lumped elements alone, harmonic filtering property is the most important benefit of the mixed structure. Furthermore, the physical circuit interconnections are made by nonredundant transmission line elements, help and contribute to the filtering performance of the structure.

### **3 A SEMI-ANALYTIC PROCEDURE FOR DESCRIBING LOSSLESS TWO-PORT MIXED (LUMPED AND DISTRIBUTED ELEMENT) NETWORKS**

This chapter is committed to initiating the fundamental concepts and description of two-variable cascaded mixed (lumped and distributed elements) networks. Two-variable characterization of mixed cascades will be encountered and the discussion on the problems related to the creation of network functions with two variables will be studied, based on scattering parameters.

#### **3.1 Two Variable Characterization of Cascaded Mixed Elements (Lumped and Distributed) Two-port Networks**

In several engineering problems, complex function with multivariable are commonly used to describe the response of a system. Design of a micro wave lossless two-port network constituted mixed lumped-distributed elements can be considered as a best example as designing of microwave lossless two-ports composed of mixed lumped-distributed elements. A microwave filter or a matching network may contain equal length transmission lines as well as lumped elements. To work with these kind of problems, the lumped sections of problems are expressed in terms of the complex frequency variable  $p$  and the distributed section is described by using Richards variable  $\lambda = \tanh p\tau$ . To describe this system mathematically, a complex two variable function is used. Indeed, both complex variables  $\lambda$  and  $p$  are hyperbolically dependent so that makes it a single variable problem. However, if we assume that both complex variables  $\lambda$  and  $p$  are independent then it can be solved as two variable problem (Koga, 1971). KOGA has studied the existence of a relationship between multivariable and a certain class of single-variable transcendental functions (Koga, 1971). His work is redesigned for two-variable case is as follows;

- A rational multivariable function  $S(p, \lambda)$  is bounded if and only if the single variable function  $S(p, \lambda = \tanh p\tau)$  is bounded for all  $\tau$ .

Two variable scattering matrix representation of a lossless two-ports composed of mixed lumped-distributed elements is  $S(p, \lambda)$  and transfer scattering matrix representation is  $T(p, \lambda)$ . The canonic representation of  $S(p, \lambda)$  and  $T(p, \lambda)$ , in terms of two-variable polynomials  $g(p, \lambda)$ ,  $h(p, \lambda)$ , and  $f(p, \lambda)$  is (Fettweis, 1982);

$$S(p, \lambda) = \frac{1}{g(p, \lambda)} \begin{bmatrix} h(p, \lambda) & \sigma f(-p, -\lambda) \\ f(p, \lambda) & -\sigma h(-p, -\lambda) \end{bmatrix} \quad (3.1)$$

$$T(p, \lambda) = \frac{1}{f(p, \lambda)} \begin{bmatrix} \sigma g(-p, -\lambda) & h(p, \lambda) \\ \sigma h(-p, -\lambda) & g(p, \lambda) \end{bmatrix} \quad (3.2)$$

The properties of canonic polynomial  $f, g, and h$  are given as (Aksen, 1994) (ŞENGÜL, 2006).

- $f$  is monic, i.e. its leading coefficient is equal to unity.
- $g$  is strictly Hurwitz polynomial.
  1.  $g(p, \lambda) \neq 0$  for  $\text{Re} \{p, \lambda\} > 0$ ,
  2.  $g(p, \lambda) \neq 0$  is relatively prime with  $g(-p, -\lambda)$ .
- $f = f(p, \lambda), g = g(p, \lambda)$  and  $h = h(p, \lambda)$  are real polynomials in complex frequency domain.
- The relation between  $f, g$  and  $h$  is,

$$g(p, \lambda)g(-p, -\lambda) = h(p, \lambda)h(-p, -\lambda) + f(p, \lambda)f(-p, -\lambda) \quad (3.3)$$

- $\sigma$  is constant with value  $\pm 1$ .
- If two-port network includes UEs, then the definition of  $f$  will be,

$$f(p, \lambda) = f(p)f(\lambda) = f(p)f(1 - \lambda^2)^{n_\lambda/2} \quad (3.4)$$

where  $n_\lambda$  is showing the number of unit elements UEs.

In the upcoming sections, the discussion on the cascades of mixed lumped and distributed two-port lossless networks is entirely based on the canonic representation of scattering matrix.

### 3.1.1 Basic Definitions and Properties

In this section, to get understanding and awareness about common terminologies, some fundamental definitions will be introduced to represent the properties of lossless two-port networks made up of mixed lumped and distributed elements.

#### 3.1.1.1 Lossless Lumped ladder

**Definition 1:** A lossless two-port, consists of just a single transmission zero in  $p$  domain will be referred to as *simple lumped section* (SLS).

The transmission zeros of the SLS on the finite  $i\omega$ -axis are located at  $p = 0$ ,  $p = \infty$  and  $p = i\omega$  and realization of the concept is shown in Figure 3.1. The point should be noted that the transmission zeroes of  $i\omega$ -axis must always be present with its complex conjugate as a pair. To fulfill the practical desires, transmission zeroes at  $p = 0$  and/or  $p = \infty$  are preferred to be work with.

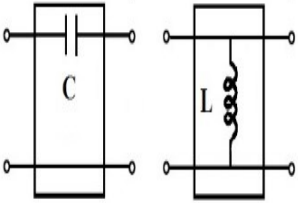
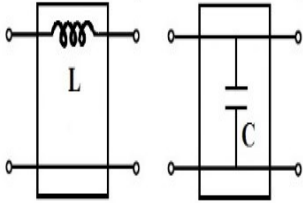
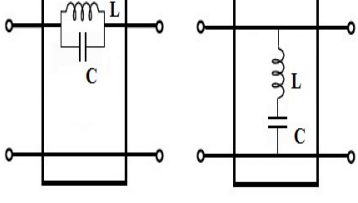
Transmission zeros and their corresponding realization in $p$ domain		
$p = 0$	$p = \infty$	$p = \pm i\omega_0$
		

**Figure 3.1 Simple Lumped Section.**

**Definition 2:** Cascaded connection of SLS, consists of just  $i\omega$  transmission zeros in  $p$  domain will be referred to as *lossless lumped ladder* (LLL) or simply *ladder network*.

Belevitch's scattering representation of an LLL network is,

$$S(p) = \frac{1}{g(p)} \begin{bmatrix} h(p) & \sigma f(-p) \\ f(p) & -\sigma h(-p) \end{bmatrix} \quad (3.5)$$

The properties of canonic real polynomial  $f(p)$ ,  $g(p)$ , and  $h(p)$  are given as (Aksen, 1994) (ŞENGÜL, 2006).

- $f$  is monic, i.e. its leading coefficient is equal to unity.
- $g$  is strictly Hurwitz polynomial.
- $f = f(p)$ ,  $g = g(p)$  and  $h = h(p)$  are real polynomials in complex frequency domain.
- The relation between  $f$ ,  $g$  and  $h$  is,

$$g(p)g(p) = h(p)h(-p) + \sigma f^2(p) \quad (3.6)$$

- $\sigma$  is constant and  $f(\sigma = \pm 1)$ .

Equation 3.6 in turn imply following degree relations,

$$\deg h \leq \deg g \quad \text{and} \quad \deg h \leq \deg f \quad (3.7)$$

The term  $\deg g - \deg f$  is representing the number of transmission zeros at infinity and the information about the degree of lossless two-port network lies and equal to the degree of polynomial  $g$ .

Consider  $n_p = \deg g$  and the coefficient form of  $f(p)$ ,  $g(p)$ , and  $h(p)$ .

$$f(p) = \sum_{k=0}^{n_p} f_k p^k, \quad h(p) = \sum_{k=0}^{n_p} h_k p^k, \quad g(p) = \sum_{k=0}^{n_p} g_k p^k \quad (3.8)$$



In 3.8 all the polynomials are considered as of degree  $n_p$  for the sake of convenience to formulate the upcoming equations. From 3.7, the inequality relations of degree of polynomial that if  $\deg f < n_p$  and  $\deg h < n_p$  one must set corresponding coefficient of the polynomial  $h$  and  $f$  equal to zero. Consider 3.6 which led us to,

$$\begin{aligned} F(-p^2) &= f(p)f(-p) = \sum_{k=0}^{n_p} f_k p^{2k} \\ H(-p^2) &= h(p)h(-p) = \sum_{k=0}^{n_p} h_k p^{2k} \\ G(-p^2) &= g(p)g(-p) = \sum_{k=0}^{n_p} g_k p^{2k} \end{aligned} \quad (3.9)$$

The coefficient of  $F_k$ ,  $G_k$  and  $H_k$  can be given as,

$$F_k = \sum_{l=0}^{2k} f_l f_{2k-l}, \quad G_k = \sum_{l=0}^{2k} (-1)^{2k-l} g_l g_{2k-l}, \quad H_k = \sum_{l=0}^{2k} (-1)^{2k-l} h_l h_{2k-l} \quad (3.10)$$

where set the values of  $f_l = g_l = h_l = 0$  for  $l > n_p$  and by using the relationship in 3.10 the lossless relation in 3.6 can be given as,

$$G(-p^2) = H(-p^2) + F(-p^2) \quad (3.11)$$

The following set of  $n_p + 1$  quadratic equations can be obtained.

$$\begin{aligned} g_0^2 &= h_0^2 + f_0^2 \\ g_k^2 + 2 \sum_{l=0}^{k-1} (-1)^{k-l} g_l g_{2k-l} &= h_k^2 + f_k^2 + 2 \sum_{l=0}^{k-1} (-1)^{k-l} (h_l h_{2k-l} + f_l f_{2k-l}) \\ &\vdots \\ g_{n_p}^2 &= h_{n_p}^2 + f_{n_p}^2 \end{aligned} \quad \text{for } k = 1, 2, \dots, n_p - 1 \quad (3.12)$$

where set the values of  $f_l = g_l = h_l = 0$  for  $l > n_p$ .

### 3.1.1.2 Cascaded Distributed Section

**Definition 1:** A lossless two-port network, consists of just a single transmission line of characteristic impedance  $Z_0$  and delay length  $\tau$  is called a *simple distributed section* (SDS).

It is clear now, that SDS may include a unit element or open or short remnant in series or shunt configuration. Figure 3.2 is a depiction of the Richard's domain realization and transmission zeroes associated with *simple distributed section* and here open stubs are represented by  $\lambda$ -capacitors and short stubs are represented by  $\lambda$ -inductors.

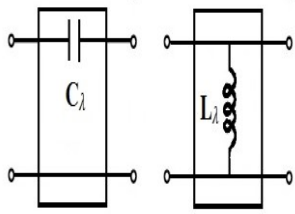
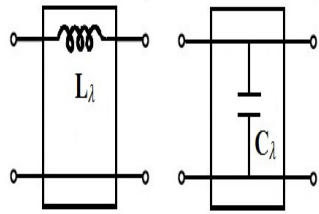
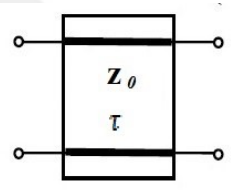
Transmission zeros and their corresponding realization in $p$ domain		
$\lambda = 0$	$\lambda = \infty$	$\lambda = \pm 1$
		

**Figure 3.2 Simple Distributed Section.**

**Definition 2:** Cascaded connection of equal length SDS, will be referred to as *cascaded distributed section* (CDS).

**Definition 3:** A CDS, that consist of only commensurated UEs, will be called as *cascaded UE section* (CUS).

Generally, a normal CDS can be expressed in term of its bounded real scattering parameters by using Richard's variable  $\lambda$ . In this case,  $p$  will be changed into  $\lambda$  in 3.5, expression for canonic polynomial representation and a factor  $f(1 - \lambda^2)^{1/2}$  will be introduced in polynomial  $f(\lambda)$  as explained in earlier sections.

$$f(\lambda) = f_0(\lambda)f(1 - \lambda^2)^{n/2} \quad (3.13)$$

where  $f_0(\lambda)$  is real polynomial could be even or odd and  $n$  is showing the number of UEs in cascade.

Like the lumped element case, CDS can also be expressed completely in terms of  $h(\lambda)$  if  $f(\lambda)$  is preselected. So 3.6 can be written as,

$$g(\lambda)g(-\lambda) = h(\lambda)h(-\lambda) + \sigma f^2(\lambda)f(1 - \lambda^2)^n \quad (3.14)$$

where  $\sigma$  is constant, as expressed earlier.

Consider all the polynomials  $g(\lambda)$ ,  $h(\lambda)$  and  $f(\lambda)$  are of degree  $n_\lambda$  for the sake of convenience to formulate the upcoming equations. If  $h(\lambda)$  and  $f(\lambda)$  are known then the value of  $g(\lambda)$  can be estimated explicitly by factorization of  $g(\lambda)g(-\lambda)$  given in 3.14 or by solving set of quadratic equations, can be derived in similar manner as of lumped case discussed above,

$$\begin{aligned} g_0^2 &= h_0^2 + f_0^2 \\ g_k^2 + 2 \sum_{l=0}^{k-1} (-1)^{k-l} g_l g_{2k-l} &= h_k^2 + f_k^2 + 2 \sum_{l=0}^{k-1} (-1)^{k-l} (h_l h_{2k-l} + f_l f_{2k-l}) \\ &\vdots \\ g_{n_\lambda}^2 &= h_{n_\lambda}^2 + f_{n_\lambda}^2 \end{aligned} \quad \text{for } k = 1, 2, \dots, n_\lambda - 1 \quad (3.15)$$

where set the values of  $f_l = g_l = h_l = 0$  for  $l > n_\lambda$ .  $g(\lambda)$  is strictly Hurwitz polynomial.

The above discussion can be concluded in following points.

- Any LLL and CDS can completely described in terms of real coefficient of  $h$  polynomial, if  $f$  is known in advance. To achieve the desire goal, carry out Hurwitz factorization to generate  $g$  a strictly Hurwitz polynomial.
- There is another alternative method to generate  $g$ , a strictly Hurwitz polynomial. In this method a set of quadratic equation is obtained by solving the losslessness equation 3.6 and 3.14, and solve them to get  $g$ .

- In the above formulations of transfer scattering function, the numerator polynomial  $f(\lambda)$  or  $f(p)$  imposes restricted class of topologies such as ladder or cascaded distributed section. Despite the selective choice of  $f(\lambda)$  or  $f(p)$ , still there is a possibility of ending up with different circuit configurations within the past class topologies.
- While in working with one kind of network elements, either only lumped elements or only commensurate transmission line and synthesis procedures are well established in  $\lambda$  or  $p$  domain. The synthesis can easily be completed by extracting the transmission zeros, which in turn yields a degree reduction in the *driving point function*. In this case, the driving point function may be expressed as a reflection or immittance function, in Darlington sense. Extraction of simple transmission zeros from a given driving point function is equivalent to the extraction of a simple section. In this type of cascade synthesis procedure, it is not necessary to have the knowledge about *how the simple section are connected to each other*. The information about the connection is imbedded in the synthesis procedure, in the realization of single variable driving point function.

### 3.1.2 Cascaded Lumped-Distributed Two-Port Networks

**Definition 1:** A lossless two-port network, that consist of cascade connection of simple lumped section and commensurated length simple distributed sections, is known as *cascaded lumped-distributed two-port* (CLDT).

**Definition 2:** A special cascaded lumped-distributed two-port, that is formed by employing commensurate length UEs placed between the elements of an LLL referred to as *low-pass ladder with UEs* (LPLU). Here an assumption has been made that the low-pass type LLL includes the transmission zeros only at  $\infty$ .

A CLDT can be represented by using the two-variable scattering parameters, function of complex frequency variable  $\lambda$  and  $p$ . The scattering matrix representation of a CLDT can be denoted as  $S = S(p, \lambda)$  and for scattering transfer matrix  $T = T(p, \lambda)$ . The Belevitch's canonic representation in terms of two variable polynomial is as  $f = f(p, \lambda)$ ,  $g = g(p, \lambda)$  and  $h = h(p, \lambda)$  follows,

$$S = \frac{1}{g} \begin{bmatrix} h & \sigma f_* \\ f & -\sigma h_* \end{bmatrix} \quad \text{and} \quad T = \frac{1}{f} \begin{bmatrix} \sigma g_* & h \\ \sigma h_* & g \end{bmatrix} \quad (3.16)$$

where  $f_* = f(-p, -\lambda)$  is paraconjugate of a real function. The properties of canonic polynomial  $f, g$ , and  $h$  are given as (Aksen, 1994) (ŞENGÜL, 2006).

- $f$  is monic, i.e. its leading coefficient is equal to unity.
- $\sigma$  is constant and  $\sigma = \pm 1$ .
- $g$  is strictly Hurwitz polynomial.
  1.  $g(p, \lambda) \neq 0$  for  $\text{Re} \{p, \lambda\} > 0$ ,
  2.  $g(p, \lambda) \neq 0$  is relatively prime with  $g(-p, -\lambda)$ .
- $f, g$  and  $h$  are real polynomials with complex variable  $\lambda$  and  $p$ .
- The relation between  $f, g$  and  $h$  is,

$$gg_* = ff_* + hh_* \quad (3.17)$$

- If two-port network includes UEs, then the definition of  $f$  will be,

$$f = f_0(p, \lambda) f(1 - \lambda^2)^{n/2} \quad (3.18)$$

where  $u$  is showing the number of unit elements UEs.

### 3.1.2.1 Connectivity Information Cascaded Lumped-Distributed Two-Port Networks

It is proven fact that canonic representation of two-variable network is possible (Fettweis, 1982). As for as the realizability conditions are concerned, it has also been asserted that scattering matrix satisfying the conditions explained in earlier sections (Aksen, 1994). While working with the case of cascaded topology, to insure the realizability and practicability as a cascade network then the scattering matrix and its canonic polynomial with two variables must satisfy some more conditions. The most intuitive way to apply these extra conditions for cascaded structures is to study the effect of the topologic constraints and restrictions on the polynomial form. To achieve our purpose, some properties of the polynomials  $f, g$  and  $h$  related to cascaded lumped-distributed two-port are discussed as follows,

Let's start with the introductory notations and fundamental definition related to the two-variable polynomials, will be used in upcoming discussion. A two variable polynomial say,  $g = g(p, \lambda)$ , its coefficient form will be,

$$g(p, \lambda) = \sum_{k=0}^{n_\lambda} \sum_{l=0}^{n_p} g_{kl} p^l \lambda^k \quad (3.19)$$

where  $n_\lambda$  is a partial degree of  $g$  in the variables  $\lambda$  and  $n_p$  is partial degrees of  $g$  in the variables  $p$ . The arrangement shown in 3.19 can also be rearrange and written as,

$$g(p, \lambda) = \sum_{k=0}^{n_p} g_k(\lambda) p^k = \sum_{k=0}^{n_\lambda} g_k(p) \lambda^k \quad (3.20)$$

There is another form to represent a two-variable polynomial is,

$$g(p, \lambda) = \mathbf{p}^T \mathbf{A}_g \boldsymbol{\lambda} = \boldsymbol{\lambda}^T \mathbf{A}_g \mathbf{p} \quad (3.21)$$

where

$$\mathbf{A}_g = \begin{bmatrix} g_{00} & g_{01} & \dots & g_{0n_\lambda} \\ g_{10} & g_{11} & \dots & g_{1n_\lambda} \\ \vdots & \vdots & \ddots & \vdots \\ g_{n_p 0} & g_{n_p 1} & \dots & g_{n_p n_\lambda} \end{bmatrix}, \mathbf{p} = \begin{bmatrix} 1 \\ p \\ p^2 \\ \vdots \\ p^{n_p} \end{bmatrix} \text{ and } \boldsymbol{\lambda} = \begin{bmatrix} 1 \\ \lambda \\ \lambda^2 \\ \vdots \\ \lambda^{n_\lambda} \end{bmatrix} \quad (3.22)$$

**Definition 1:** The highest power of a variable, with non-zero coefficient is the definition of a two-variable polynomial  $g = g(p, \lambda)$ , i.e.  $n_p = \deg_p g(p, \lambda)$  and  $n_\lambda = \deg_\lambda g(p, \lambda)$ .

**Definition 2:** The absolute total degree of a two-variable polynomial  $g(p, \lambda)$  with partial degrees  $n_p$  and  $n_\lambda$ , will be equal to the sum of these partial degrees and mathematically can be expressed as,

$$n = \max_{g_{kl} \neq 0} \{k + l\} \quad k = 0, 1, \dots, n_p, \quad l = 0, 1, \dots, n_\lambda \quad (3.23)$$

Now from a cascaded topology consider the transmission zeroes. It is critical to select and appropriate  $f(p, \lambda)$  function for a mixed lumped-distributed two-port, because  $f(p, \lambda)$  includes transmission zeros, which in turn enforce topological restrictions on the loss two-port constructed with lumped elements and commensurated distributed elements.

In a mixed element design composed of cascaded connection of  $n_p$  lumped and  $n_\lambda$  distributed elements. The polynomial  $f(p, \lambda)$  can be given as,

$$f(p, \lambda) = \prod_{k=1}^n f_k(p) f_k(\lambda) \quad (3.24)$$

where  $f_k(p)$  and  $f_k(\lambda)$  interpret the transmission zeros of discrete lumped and distributed subsegments present in the cascade. Generally, the transmission zeros can possess any place in the  $p$  and  $\lambda$  plane. From 3.24, an immediate conclusion can be drawn, that in the cascade the transmission zeros in each subsegment have to appear in multiplication form. In simple words, the polynomial  $f(p, \lambda)$  of whole mixed element network can be assumed as product separable form,

$$f(p, \lambda) = f'(p)f''(\lambda) \quad (3.25)$$

$f'(p)$  will be a real even or odd polynomial if the transmission zeroes are considered on the imaginary axis  $i\omega$  or  $i\Omega$ , and general expression for  $f''(\lambda)$  is,

$$f''(\lambda) = f_0(\lambda)f(1 - \lambda^2)^{n/2} \quad (3.26)$$

where  $u$  is indication the number of UEs present in the principal path from input to output of CLDT. By overlooking the zeros of the finite imaginary axis in  $f'(\lambda)$  and  $f''(\lambda)$  (*excluding those at dc*), a realistic form of  $f(p, \lambda)$  can be derived as,

$$f(p, \lambda) = p^{q_1} \lambda^{q_2} f(1 - \lambda^2)^{n/2} \quad (3.27)$$

here total number of transmission zeros at dc of the lumped and distributed are represented by  $q_1$  and  $q_2$  respectively. After excluding the transmission zeros at  $dc$ , the expression in 3.27 can be written as,

$$f(p, \lambda) = f(1 - \lambda^2)^{n/2} \quad (3.28)$$

This is the characteristic configuration of  $f(p, \lambda)$  of an LPLU design composed of simple lumped elements and UEs. It is clear in this case that  $f(p, \lambda)$  is only dependent function of  $\lambda$ . Matrix representation of the real coefficients of  $g(p, \lambda)$  and  $h(p, \lambda)$  is,

$$\mathbf{A}_h = \begin{bmatrix} h_{00} & h_{01} & \dots & h_{0n_\lambda} \\ h_{10} & h_{11} & \dots & h_{1n_\lambda} \\ \vdots & \vdots & \ddots & \vdots \\ h_{n_p 0} & h_{n_p 1} & \dots & h_{n_p n_\lambda} \end{bmatrix}, \quad \mathbf{A}_g = \begin{bmatrix} g_{00} & g_{01} & \dots & g_{0n_\lambda} \\ g_{10} & g_{11} & \dots & g_{1n_\lambda} \\ \vdots & \vdots & \ddots & \vdots \\ g_{n_p 0} & g_{n_p 1} & \dots & g_{n_p n_\lambda} \end{bmatrix} \quad (3.29)$$

**Property 1:** The two-variable polynomial  $g(p, \lambda)$ ,  $h(p, \lambda)$  and  $g(p, \lambda)$  can be expressed in term of a single variable  $p$  by putting  $\lambda = 0$ , the lumped lossless two-port in this case can be completely described by columns of  $\mathbf{A}_h$  matrix.

**Property 2:** The two-variable polynomial  $g(p, \lambda)$ ,  $h(p, \lambda)$  and  $g(p, \lambda)$  can be expressed in term of a single variable  $\lambda$  by putting  $p = 0$ , the lumped lossless two-port in this case can be completely described by rows of  $\mathbf{A}_h$  matrix.

According to the above properties, it can be proved that the coefficient matrices  $\mathbf{A}_h$  and  $\mathbf{A}_g$  can entirely be generated by using first column and first row of matrix  $\mathbf{A}_h$ , if the information about the cascaded connection is pre-known, while assuming the cascaded connections of lumped and distributed two-ports structures, in alternating order. This claim can be proved by considering following assumption,



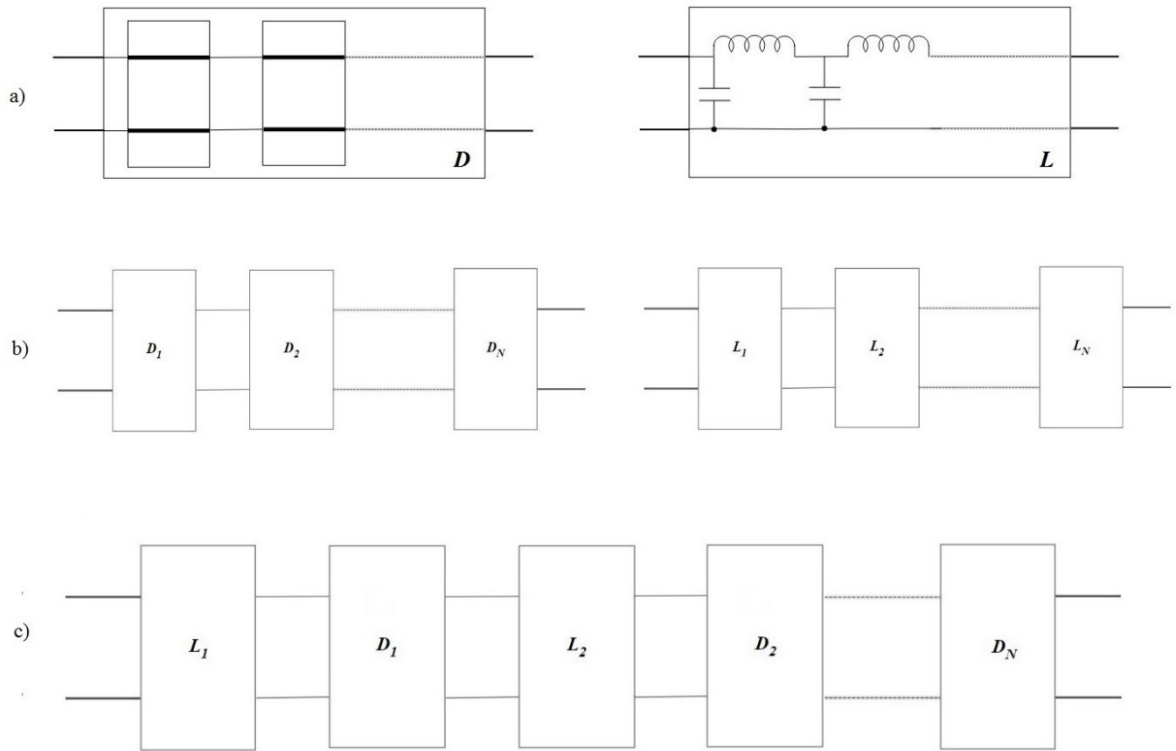

**Figure 3.3 a) Cascaded Distributed Design and Lossless Lumped Ladder. b) Cascaded Decomposition. c) Cascade of Simple Lumped and Distributed Section.**

Consider Figure 3.3(a) where  $L$  is representing LLL (lossless lumped ladder) and  $D$  is denoting CSD (cascaded distributed section). With the help of *algebraic network decomposition technique* (Aksen, 1994) the network present in Figure 3.3 can be decomposed into their  $L_k$  and  $D_k$  subsections as depicted in Figure 3.3(a). Now consider Figure 3.3(c), in which a lossless two-port network is constructed by using alternating ordered cascade connections of lumped and distributed subsections.

Assume that  $S(\lambda)$  and  $S(p)$  are respectively representing the scattering matrix  $S(p, \lambda)$  of cascaded distributed section  $D$  and lossless lumped ladder  $L$ . In this representation, the scattering matrix of the developed mixed composition, can be determined in terms of scattering matrices of subsections  $S_k(\lambda)$  and  $S_k(p)$ , determine from  $S(\lambda)$  and  $S(p)$  respectively. While working on the decomposition of  $S(\lambda)$  and  $S(p)$ , the number of elements and the corresponding zeros of transmission are designer's choice for every subsegment, after these selections with

no effort scattering parameters for each subsection can be derived from  $S(\lambda)$  and  $S(p)$ . The scattering parameters of mixed structure can be calculated effortlessly by cascading these subsections.

The summary of above explained idea can be stated again, regarding to the scattering parameters matrix of mixed lumped-distributed networks, the observations are as following,

- For  $\lambda = 0$ ,  $S(p, 0) = S(p)$
- For  $p = 0$ ,  $S(0, \lambda) = S(\lambda)$

From above points, if the number of subsection pre-chosen and the information about the connections (the order of subsection) is known then from the first row and first column of matrix  $\mathbf{A}_h$ , the scattering parameters  $S(p, \lambda)$  can be obtained easily. If  $\lambda = 0$  and  $f(p)$  is given, then by using  $h(p)$  polynomial of  $S(p)$  the first column of  $\mathbf{A}_h$  and  $\mathbf{A}_g$  can be developed easily. Similarly, if  $p = 0$  and  $f(\lambda)$  is given, then by using  $h(\lambda)$  polynomial of  $S(\lambda)$  the first row of  $\mathbf{A}_h$  and  $\mathbf{A}_g$  can be obtained readily. Afterwards, by using the connectivity information of sequential cascades remain elements of the matrices  $\mathbf{A}_h$  and  $\mathbf{A}_g$  can be generated with the help of  $S_k(\lambda)$  and  $S_k(p)$ . So, the point can be affirmed that by deleting the first row and first column of  $\mathbf{A}_h$  and  $\mathbf{A}_g$  the submatrix can be obtained, and these submatrices are related to the connectivity information of mixed structures.

Let's separate the first columns  $\mathbf{A}_{h_c}$  and  $\mathbf{A}_{g_c}$  and first rows  $\mathbf{A}_{h_r}$  and  $\mathbf{A}_{g_r}$  of matrices  $\mathbf{A}_h$  and  $\mathbf{A}_g$  and the remain matrices can be named as  $\mathbf{A}_{h_k}$  and  $\mathbf{A}_{g_k}$  respectively and can be given as,

$$\mathbf{A}_{h_r} = \begin{bmatrix} h_{00} \\ h_{01} \\ \vdots \\ h_{0n_\lambda} \end{bmatrix}, \quad \mathbf{A}_{h_c} = \begin{bmatrix} h_{00} \\ h_{10} \\ \vdots \\ h_{n_p} \end{bmatrix}, \quad \mathbf{A}_{h_k} = \begin{bmatrix} h_{11} & h_{12} & \cdots & h_{1n_\lambda} \\ h_{21} & h_{22} & \cdots & h_{2n_\lambda} \\ \vdots & \vdots & \ddots & \vdots \\ h_{n_p1} & h_{n_p1} & \cdots & h_{n_p n_\lambda} \end{bmatrix} \quad (3.30)$$

$$\mathbf{A}_{g_r} = \begin{bmatrix} g_{00} \\ g_{01} \\ \vdots \\ g_{0n_\lambda} \end{bmatrix}, \quad \mathbf{A}_{g_c} = \begin{bmatrix} g_{00} \\ g_{10} \\ \vdots \\ g_{n_p} \end{bmatrix}, \quad \mathbf{A}_{g_k} = \begin{bmatrix} g_{11} & g_{12} & \cdots & g_{1n_\lambda} \\ g_{21} & g_{22} & \cdots & g_{2n_\lambda} \\ \vdots & \vdots & \ddots & \vdots \\ g_{n_p1} & g_{n_p1} & \cdots & g_{n_p n_\lambda} \end{bmatrix} \quad (3.31)$$

here,  $[\mathbf{A}_{h_r}, \mathbf{A}_{g_r}]$  and  $[\mathbf{A}_{h_c}, \mathbf{A}_{g_c}]$  are representing the polynomials of  $h(\lambda)$  and  $g(\lambda)$  distributed cascaded designs and lumped cascades respectively, as shown **Error! Reference source not found.** and the information about the connection order of subsection in the cascade is determining the submatrices  $[\mathbf{A}_{h_k}, \mathbf{A}_{g_k}]$  of order  $n_p \times n_\lambda$ .

## 3.2 Construction of Two-variable Network for Cascaded Designs

In this specific part, our goal is to develop a real parameter characterize the lossless two-port networks built with mixed lumped and distributed elements and to achieve our aim simplified real frequency technique(SRFT) is used (Aksen, 1994). Generally, in SRFT a lossless two-port network made up of single kind of elements, lumped or distributed can only be express completely in terms of real polynomial of  $h$  and polynomial  $f$  is given. In our recent problem it may be suitable to apply SRFT to extract real coefficient of  $h(p, \lambda)$  polynomial of lossless mixed two-port with lumped and distributed elements.

### 3.2.1 Factorization of Two-Variable Polynomials

While studying the case of a single polynomial, the factorization of polynomial can be done by simply finding the roots, and there are well established tools are present to find location of roots. But, in the case of multivariable polynomial, root finding is not possible by using conventional tools unless they are separable in each variable (Seaks, 1976) (Bose, 1982). This is the basic reason that causes the major problem in synthesizing the network functions with multivariable.

In designing the lossless mixed two-ports (lumped and distributed elements), paraunitary condition needs to be encounter with, that requires the explicit factorization of a two-variable polynomial of the form  $G(p, \lambda) = g(p, \lambda)g(-p, -\lambda)$  if the network is advised in terms of real coefficients of the  $h(p, \lambda)$  polynomial. Root finding technique to factorize the single variable polynomial may be considered as an equivalent method to find the solution for a set of quadratic equations. By using this approach, it may be possible to obtain a generalized factorization procedure for multivariable polynomials with the restricted condition that  $g(p, \lambda)$  is strictly *Hurwitz polynomial* in nature.

To be more specific, the polynomial  $f(p, \lambda)$ ,  $g(p, \lambda)$  and  $h(p, \lambda)$  can be written as,

$$f(p, \lambda) = \sum_{k=0}^{n_p} f_k(\lambda)p^k, \quad g(p, \lambda) = \sum_{k=0}^{n_p} g_k(\lambda)p^k, \quad (3.32)$$

$$\text{and } h(p, \lambda) = \sum_{k=0}^{n_p} h_k(\lambda)p^k$$

where the coefficients of polynomials  $f_k$ ,  $g_k$  and  $h_k$  are,

$$f_k(\lambda) = \sum_{l=0}^{n_\lambda} f_{kl}\lambda^l, \quad g_k(\lambda) = \sum_{l=0}^{n_\lambda} g_{kl}\lambda^l, \quad h_k(\lambda) = \sum_{l=0}^{n_\lambda} h_{kl}\lambda^l \quad (3.33)$$

unitary conditions from 3.17, can be given as

$$G(p, \lambda) = H(p, \lambda) + F(p, \lambda) \quad (3.34)$$

where,

$$G(p, \lambda) = G(p, \lambda)G(-p, -\lambda), \quad H(p, \lambda) = H(p, \lambda)H(-p, -\lambda), \quad (3.35)$$

$$\text{and } (p, \lambda) = (p, \lambda)(-p, -\lambda)$$

and,

$$G(p, \lambda) = G_0(\lambda) + G_1(\lambda)p + G_2(\lambda)p^2 + \dots + G_{n_p}(\lambda)p^{n_p} \quad (3.36)$$

where the coefficient polynomials  $G_k(\lambda)$  are,

$$G_k(\lambda) = \sum_{l=0}^k (-1)^k g_{k-l}(\lambda)g_l(-\lambda), \quad \text{for } k = 0 \text{ to } 2n_p \quad (3.37)$$

where  $g_l = 0$  for  $l > 0$ .

If the expression 3.37 is examined closely, the fact will be revealed that for even values of  $k$ ,  $G_k(\lambda)$  is even and for odd values of values of  $k$ ,  $G_k(\lambda)$  is odd. The whole expression in 3.34

can be written in the similar generic form used in expression 3.37 and by equating the coefficients polynomial of same power  $p$ , the obtained  $(2n_p + 1)$ , equations can be given as,

$$\sum_{l=0}^k (-1)^k g_{k-l}(\lambda) g_l(-\lambda) = \sum_{l=0}^k (-1)^k [h_{k-l}(\lambda) h_l(-\lambda) + f_{k-l}(\lambda) f_l(-\lambda)] \quad (3.38)$$

$\vdots$   
 for  $k = 0$  to  $2n_p$

where  $g_l = h_l = f_l = 0$  for  $l > n_p$ .

The equation set in 3.38, have  $n_p + 1$  equation with even polynomials and  $n_p$  equation with odd polynomials. Now, substitution the polynomials  $f_k, g_k$  and  $h_k$  of 3.33 in 3.38 and by comparing the coefficients having same power of  $\lambda$  in each polynomial equation, following set of nonlinear equation are obtained,

$$g_{0,m}^2 + 2 \sum_{n=0}^{m-1} (-1)^{m-n} g_{0,n} g_{0,2m-n} = h_{0,m}^2 + f_{0,m}^2$$

$$+ 2 \sum_{n=0}^{m-1} (-1)^{m-n} [h_{0,n} h_{0,2m-n} + f_{0,n} f_{0,2m-n}] \quad (3.39)$$

$\vdots$   
 for  $m = 0$  to  $2n_\lambda$

$$\sum_{l=0}^k \sum_{n=0}^m (-1)^{k-l-n} g_{l,n} g_{k-l,2m-1-n}$$

$$= \sum_{l=0}^k \sum_{n=0}^m (-1)^{k-l-n} [h_{l,n} h_{k-l,2m-1-n} + f_{l,n} f_{k-l,2m-1-n}] \quad (3.40)$$

$\vdots$   
 for  $k = 1, 3, \dots, 2n_p - 1$  and  $m = 0$  to  $2n_\lambda$

$$\begin{aligned}
& \sum_{l=0}^k (-1)^{k-l} (g_{l,m} g_{k-l,m} + 2 \sum_{n=0}^{m-1} (-1)^{m-n} g_{l,n} g_{k-l,2m-n}) \\
&= \sum_{l=0}^k (-1)^{k-l} (h_{l,m} h_{k-l,m} + f_{l,m} f_{k-l,m} \\
&+ 2 \sum_{n=0}^{m-1} (-1)^{m-n} [h_{l,n} h_{k-l,2m-n} + f_{l,n} f_{k-l,2m-n}] \\
&\quad \vdots \quad \text{for } k = 2, 4, \dots, 2n_p - 2 \text{ and } m = 0 \text{ to } n_\lambda
\end{aligned} \tag{3.41}$$

$$\begin{aligned}
g_{n_p,m}^2 + 2 \sum_{n=0}^{m-1} (-1)^{m-n} g_{n_p,n} g_{0,2m-n} &= h_{n_p,m}^2 + f_{n_p,m}^2 \\
+ 2 \sum_{n=0}^{m-1} (-1)^{m-n} [h_{n_p,n} h_{n_p,2m-n} + f_{n_p,n} f_{n_p,2m-n}] & \\
\quad \vdots \quad \text{for } m = 0 \text{ to } n_\lambda &
\end{aligned} \tag{3.42}$$

The set of equations from 3.39 to 3.42 are called as the *fundamental equation set* (FES) because the solution of above set of equations for the coefficient of  $g_{kl}$  is equivalent to factorization of  $G(p, \lambda) = g(p, \lambda)g(-p, -\lambda)$ .

Each equation in FES is quadratic and contains  $g_k$  and  $g_l$  coefficients. By inspection of each subset in each subset of FES, total number of equation  $N_e$  can be calculated and expression can be given as,

$$N_e = (n_p + 1)(n_\lambda + 1) + n_p n_\lambda \tag{3.43}$$

Now to estimate the number of unknown is important, for this purpose consider  $f(p, \lambda)$  is known then total number of unknown coefficients in polynomial  $h(p, \lambda)$  and  $g(p, \lambda)$  will be  $2(n_p + 1)(n_\lambda + 1)$ . If we consider that the first row and first column of matrix  $\mathbf{A}_h$  consists independent descriptive parameters of the lossless two-port network or the pre-known, then the remaining  $\mathbf{A}_h$  coefficients, those compose  $\mathbf{A}_{h_k}$  and all the coefficients of corresponding  $\mathbf{A}_{g_k}$  matrix have to be computed. So, in this scenario the number of unknowns in FES is greater than that number of equations hence the solution set of above equation for unknown cannot be determined. On

the other hand, by using one subset of above system of equation the elements of first row and first column can be calculated. In fact, a close examination of above FES unveils the following,

- As  $n_p + 1$  independent equations are expressed in terms of  $\{g_{k0}, h_{k0}, f_{k0}\}$ , ( $k = 0, 1, \dots, n_p$ ). It reflects that  $f_{k0}, h_{k0}$  are known and the unknowns  $g_{k0}$  can be calculated by the help of  $n_p + 1$  independent equations. i.e.,

$$\begin{aligned}
 g_{0,0}^2 &= h_{0,0}^2 + f_{0,0}^2 \\
 g_{m,0}^2 + 2 \sum_{n=0}^{m-1} (-1)^{m-n} g_{n,0} g_{2m-n,0} \\
 &= h_{m,0}^2 + f_{m,0}^2 + 2 \sum_{n=0}^{m-1} (-1)^{m-n} (h_{n,0} h_{2m-n,0} + f_{n,0} f_{2m-n,0}) \quad (3.44) \\
 &\vdots \\
 g_{n_p,0}^2 &= h_{n_p,0}^2 + f_{n_p,0}^2 \quad \text{for } k = 1, 2, \dots, n_p - 1
 \end{aligned}$$

one thing must be kept in mind while working with this scenario that the resulting coefficients  $g_{k0}$  are positive and real and satisfying the condition that  $g(p, \lambda)$  is strictly scattering Hurwitz polynomial.

- $n_\lambda + 1$  independent equations are expressed in terms of  $\{g_{0l}, h_{0l}, f_{0l}\}$ , ( $k = 0, 1, \dots, n_\lambda$ ). It reflects that  $f_{0l}, h_{0l}$  are known and the unknowns  $g_{0k}$  can be calculated by the help of  $n_\lambda + 1$  independent equations in such a way that the resulting coefficients  $g_{0l}$  are positive and real and satisfying the condition that  $g(p, \lambda)$  is strictly scattering Hurwitz polynomial. i.e.,

$$\begin{aligned}
 g_{0,0}^2 &= h_{0,0}^2 + f_{0,0}^2 \\
 g_{0,m}^2 + 2 \sum_{n=0}^{m-1} (-1)^{k-l} g_{0,n} g_{0,2m-n} \\
 &= h_{0,k}^2 + f_{0,k}^2 + 2 \sum_{n=0}^{m-1} (-1)^{m-n} (h_{0,n} h_{0,2m-n} + f_{0,n} f_{0,2m-n}) \quad (3.45) \\
 &\vdots \\
 &\quad \text{for } k = 1, 2, \dots, n_\lambda - 1
 \end{aligned}$$

$$g_{0,n_\lambda}^2 = h_{0,n_\lambda}^2 + f_{0,n_\lambda}^2$$

Now the problem is to calculate the remaining coefficients in  $g(p, \lambda)$  and  $h(p, \lambda)$  to satisfy the FES and these unknowns coefficients are constitutes of matrices  $\mathbf{A}_{h_k}$  and  $\mathbf{A}_{g_k}$  of order  $n_p \times n_\lambda$ . The total number of unknown  $N_u$  can be given as,

$$N_u = 2n_p n_\lambda \quad (3.46)$$

Subtracting 3.46 from 3.43 the result is,

$$N_e - N_u = n_p + n_\lambda + 1 \quad (3.47)$$

from 3.47, it can be concluded that the solution of FES is still overdetermined. The intuitive approach imposes that for a realistic system the number of equation and number of unknowns must be same. Therefor to picture a practical system  $n_p + n_\lambda + 1$  independent conditions are required. Previously it has been discussed, the coefficients of submatrices  $\mathbf{A}_{h_k}$  and  $\mathbf{A}_{g_k}$  can be readily related to the connectivity information of cascaded systems as shown in Figure 3.3. In this case, the information about connectivity must be given or estimated on such lines that the obtained  $g(p, \lambda)$  is scattering Hurwitz polynomial. On the other hand, to define a generalized explicit solution to obtain  $g(p, \lambda)$  as a strict Hurwitz scattering polynomial is not clear because FES is nonlinear. Therefore, to realize a practical system, some properties of fundamental equation set must be explored, and necessary restriction and constraints must be developed. Unfortunately, there is no general analytical solution has been proposed yet that can give an acceptable solution. However, for some limited classes of circuit configuration, the solution of FES is possible up to a certain complexity by using conventional algebraic numerical methods, provided that a sufficient information about connectivity is given. As an example, the explicit solution for 5 element ladder structure composed of simple lumped sections connected by mean UEs can be calculated. For more general cascades, a new approach has been proposed that based on the algebraic decomposition technique, which results an acceptable solution for FES. The proposed method is called “*Standard Decomposition Technique*” (SDT) explain in upcoming sections.



### 3.2.2 Construction of Low-Pass Ladders with Unit Elements(UEs)

As far as the practical implementation is concerned, alternating connections of simple lumped first order sections with unit elements, is considered as the most practical circuit configuration as shown in Figure 3.3. This kind of circuits are known as *low pass ladders with unit elements* and short form is LPLU or LPLUE. The properties of scattering polynomial describing the LPLU can be summarized as following,

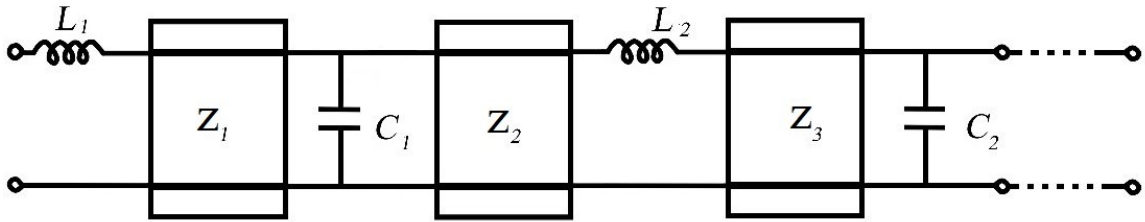

**Figure 3.4 Low-pass Ladder with Unit Elements.**

- LPLU includes first order lumped sections with transmission zero only at  $\infty$ , and unit elements with transmission zeros at  $\lambda = \pm 1$ . So, the polynomial  $f(p, \lambda)$  of the discussed LPLU can be given as,

$$f(p, \lambda) = f(1 - \lambda^2)^{n_\lambda/2} \quad (3.48)$$

where  $n_\lambda$  is representing the number of UEs used in ladder.

- For the sake of normalized input and output, the coefficients of the constant term of the polynomial  $h(p, \lambda)$  are selected as  $g_{00} = 1$  and  $h_{00} = 0$ , for a transform free implementation. A very simple justification of this choice can be given by the characteristic of reflection and transmission functions  $p = \lambda = 0$ . For a transparent network, the condition must be  $S_{11}(0,0) = 0$ , hence  $h_{00} = 0$  and  $S_{21}(0,0) = 1$ , so  $f_{00}/g_{00} = 1$  which is leading us to  $f_{00} = g_{00} = 1$  and can be seen in 3.48.

- By setting  $\lambda = 0$ , will reduce the structure only to the lumped section and the problem is now reduced to single variable problem. In this case the polynomial will be,  $\{f(p, 0), g(p, 0)$  and  $h(p, 0)\}$  are totally representing an LLL structure.
- Similarly, by considering  $p = 0$ , will reduce the structure only to the cascaded UE section and the problem now is also converted into single variable problem. In this case the polynomial will be,  $\{f(0, \lambda), g(0, \lambda)$  and  $h(0, \lambda)\}$  are completely description of a CUS structure.
- The sequential cascaded analysis of general ladder designs leads to the coefficient matrices  $\mathbf{A}_g$  and  $\mathbf{A}_h$  in 3.49 are showing the general form associated with LPLU network.

$$\mathbf{A}_h = \begin{bmatrix} 0 & h_{01} & h_{02} & \dots & h_{0n_\lambda} \\ h_{10} & h_{11} & h_{12} & \dots & h_{1n_\lambda} \\ h_{20} & h_{21} & \dots & \dots & 0 \\ \vdots & \vdots & \dots & \ddots & \vdots \\ h_{n_p 0} & \dots & 0 & \dots & 0 \end{bmatrix}, \mathbf{A}_g = \begin{bmatrix} 1 & g_{01} & g_{02} & \dots & g_{0n_\lambda} \\ g_{10} & g_{11} & g_{12} & \dots & g_{1n_\lambda} \\ g_{20} & g_{21} & \dots & \dots & 0 \\ \vdots & \vdots & \dots & \ddots & \vdots \\ g_{n_p 0} & \dots & 0 & \dots & 0 \end{bmatrix} \quad (3.49)$$

- **Properties of matrices  $\mathbf{A}_g$  and  $\mathbf{A}_h$ :**

1. The elements of  $\mathbf{A}_g$  are nonnegative and real numbers.
2.  $g_{01} = g_{01}g_{10} - h_{01}h_{10}$ ,
3.  $g_{mn} = h_{mn} = 0$  for  $m + n > n_\lambda + 1$  and  $m, n = 0, 1, \dots, n_\lambda$ ,
4.  $h_{m,n} = \rho g_{m,n}$  for  $m + n > n_\lambda + 1$  and  $m, n = 0, 1, \dots, n_\lambda$  where  $\rho = \pm 1$ ,
5.  $n_p = n_\lambda + 1$ , then  $\rho = h_{n_p 0} / g_{n_p 0} = \pm 1$ .

The existence of these properties is because of the recursive behavior of LPLU structure and readily proved in literature (Aksen, 1994).

The connectivity matrices  $\mathbf{A}_{g_k}$  and  $\mathbf{A}_{h_k}$  can easily be extracted form coefficient matrices  $\mathbf{A}_g$  and  $\mathbf{A}_h$  present in 3.49 and both are upper triangular.

$$\mathbf{A}_{h_k} = \begin{bmatrix} h_{11} & h_{12} & h_{13} & \dots & h_{1n_\lambda} \\ h_{21} & h_{22} & h_{23} & \dots & 0 \\ h_{31} & h_{32} & 0 & \dots & 0 \\ \vdots & \vdots & \vdots & \ddots & \vdots \\ h_{n_p 0} & 0 & 0 & \dots & 0 \end{bmatrix}, \mathbf{A}_{g_k} = \begin{bmatrix} g_{11} & g_{12} & g_{13} & \dots & h_{1n_\lambda} \\ g_{21} & g_{22} & g_{23} & \dots & 0 \\ g_{31} & g_{32} & 0 & \dots & 0 \\ \vdots & \vdots & \vdots & \ddots & \vdots \\ g_{n_p 0} & 0 & 0 & \dots & 0 \end{bmatrix} \quad (3.50)$$

In this case, it can be noticed that number of unknowns are reduced because some diagonal terms of the connectivity matrix  $\mathbf{A}_{g_k}$  are equal in magnitude to the matrix  $\mathbf{A}_{h_k}$ , furthermore, some of the coefficients are happened to be zero as well.

By using earlier discussed properties and simplified connectivity matrices  $\mathbf{A}_{g_k}$  and  $\mathbf{A}_{h_k}$ , and FES (fundamental equation set) can be solved and development of explicit solution is possible that can describe the relation between  $\mathbf{A}_g$  and  $\mathbf{A}_h$  up to degree  $n = n_p + n_\lambda$ . In next section an improved review for  $n=5$  has been presented.

### 3.2.2.1 Explicit Solution for Low Order Ladders

In this part of the novel, the explicit formulas are derived for low order and low-pass ladders. The complexity of the structure is considered up to 5 elements, and a FES is developed and solved by using the earlier described properties, to determine the explicit magnitude of the canonic polynomials.

- **LPLU of Degree Two:**

Consider a two-variable polynomial with degree one in each variable as  $n_p = n_\lambda = 1$  and the polynomial  $f, g$  and  $h$  can be given by utilizing the previously discussed details, as

$$f = (1 - \lambda^2)^{\frac{1}{2}}, \quad g = g_0 + g_1 p, \quad h = h_0 + h_1 p, \quad (3.51)$$

where  $g_k = g_{k0} + g_{k1} \lambda, \quad h_k = h_{k0} + h_{k1} \lambda, \quad \text{and} \quad k = 0, 1$

from 3.38 we can obtain,

$$\begin{aligned}
g_{0*} &= h_0 h_{0*} + (1 - \lambda^2) \\
g_1 g_{0*} + g_0 g_{1*} &= h_1 h_{0*} + h_0 h_{1*} \\
g_1 g_{1*} &= h_1 h_{1*}
\end{aligned}$$

Now by substituting the values of  $g_k$  and  $h_k$  and then comparing the coefficients of the same power of  $\lambda$ , the obtained FES will be,

$$\begin{aligned}
g_{00}^2 &= h_{00}^2 + 1 \\
g_{01}^2 &= h_{01}^2 + 1 \\
g_{01} g_{10} + g_{00} g_{11} &= h_{01} h_{01} + h_{00} h_{11} \\
g_{00}^2 &= h_{00}^2 + 1 \\
g_{01}^2 &= h_{01}^2 + 1
\end{aligned} \tag{3.52}$$

Here an assumption is made that  $g_{00} = 1$  and  $h_{00} = 0$  and  $h_{01}$  and  $h_{10}$  is taken as independent coefficients so, 3.52 is giving

$$g_{01} = (h_{01}^2 + 1)^{1/2}, \quad g_{10} = |h_{10}| \tag{3.53}$$

$$g_{11} = g_{01} g_{10} - h_{01} h_{10}, \quad h_{11} = \eta g_{11} \text{ and } \eta = \pm 1 \tag{3.54}$$

where,  $g_{kl} > 0$ , in this specific case,  $g_{01} > |h_{01}|$ .

As the polynomial are satisfying these coefficient relations, so to estimate the realizations following are to proceed. If the boundary case is considered with  $\lambda = 0$  and  $p = 0$ , then it can easily be expressed that they correspond respectively to a simple lumped element and a UE section. It can also be noticed from 3.53 and 3.54, the polynomials and coefficient relations specifically in this case are telling clearly that the values of elements obtained corresponding to respective section is always positive. This is compulsion is true because  $g(p, 0)$  and  $g(0, \lambda)$  is Hurwitz polynomial.

Suppose  $g(p, 0) = g_D$ ,  $f(p, 0) = f_D$  and  $h(p, 0) = h_D$ , also  $g(0, \lambda) = g_L$ ,  $f(0, \lambda) = f_L$  and  $h(0, \lambda) = h_L$  are notations for the representation of the boundary polynomials corresponding to the case  $p = 0$  and  $\lambda = 0$ . Form 3.66 and 3.67, we obtained following,

- **Case I ( $p = 0$ ):**

$$f_D = (1 - \lambda^2)^{\frac{1}{2}}, \quad g_D = 1 + g_{01}\lambda, \quad h_D = h_{01}\lambda, \quad (3.55)$$

where  $g_{01}^2 = 1 + h_{01}^2, \quad g_{01} > |h_{01}|$

these correlates with a UE of characteristic impedance  $R = g_{01} + h_{01} = 1/(g_{01} + h_{01}) > 0$ .

- **Case II ( $\lambda = 0$ ):**

$$f_L = 1, \quad g_L = 1 + g_{10}p, \quad h_L = h_{01}p, \quad (3.56)$$

where  $g_{10} > 0, \quad h_{10} = \eta_1 g_{10} \quad \text{and} \quad \eta_1 = \pm 1$

Here, the negative and positive signs are a representation for capacitor and inductor respectively, but their values are always positive as,  $L = 2g_{10}$  and  $C = g_{10}$ .

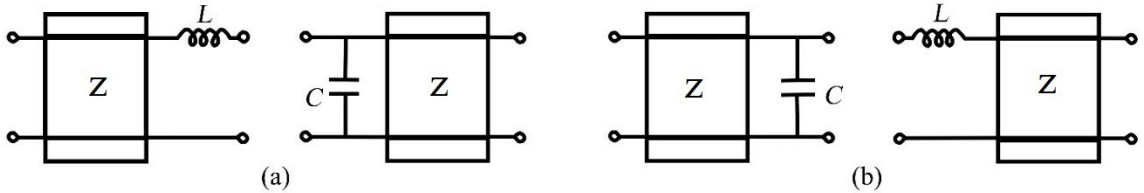

**Figure 3.5 LPLU Section of Degree Two.**

Suppose, the distributed section described by 3.55 is denoted by [D] and lumped section is denoted by [L] and a configuration is in Figure 3.5 . The polynomial corresponding to these configurations will differ only in  $g_{11}$  and  $h_{11}$ , and end up expressions are in the following form,

$$\begin{aligned} [L][D]: \quad g_{11} &= g_{01}g_{10} - h_{01}h_{10}, & h_{11} &= \eta_1 g_{11} \\ [D][L]: \quad g_{11} &= g_{01}g_{10} - h_{01}h_{10}, & h_{11} &= -\eta_1 g_{11} \end{aligned}$$

clearly, it can be noticed that these coefficients are similar to the coefficients in 3.54. It can also be seen that each case consists two configurations based on the sign of  $\eta = \pm 1$ . In above expressions  $h_{11} = \eta g_{11}$ ,  $\eta = \pm \eta_1 = \pm 1$  is used as an additional parameter. For  $\eta = +1$  sections are represented in Figure 3.5 (a) and for  $\eta = -1$  sections are represented in Figure 3.5 (b).

- **LPLU of Degree Three:**

Now Consider a two-variable polynomial with degree three so  $n_p = 2$ ,  $n_\lambda = 1$  and the polynomial  $f, g$  and  $h$  can be given by utilizing the earlier knowledge, as

$$f = (1 - \lambda^2)^{\frac{1}{2}}, \quad g = g_0 + g_1 p + g_2 p^2, \quad h = h_0 + h_1 p + h_2 p^2, \quad (3.57)$$

where  $g_k = g_{k0} + g_{k1} \lambda$ ,  $h_k = h_{k0} + h_{k1} \lambda$ , and  $k = 0, 1$

Here an assumption is made again that  $g_{00} = 1$  and  $h_{00} = 0$  and  $h_{0k}$  and  $h_{k0}$  is taken as independent coefficients so, 3.52 helps to determine  $g_{0k}$  and  $g_{k0}$  as

$$\begin{aligned} g_{01} &= (h_{01}^2 + 1)^{1/2}, & g_{01} &> |h_{01}| \\ g_{10} &= (h_{01}^2 + g_{01})^{1/2}, & g_{20} &= |h_{20}| \\ g_{11} &= g_{01} g_{10} - h_{01} h_{10}, & h_{11} &= \eta g_{11} \text{ and } \eta = \pm 1 \end{aligned} \quad (3.58)$$

where,  $g_{kl} > 0$ .

Remaining FES can be written by using the equation from 3.39 to 3.42 and those are,

$$\begin{aligned} g_{01} g_{10} - g_{11} &= h_{01} h_{10} \\ g_{21}^2 &= h_{21}^2 \\ g_{10} g_{21} - g_{11} g_{20} &= h_{10} h_{21} - h_{20} h_{11} \\ 2g_{01} g_{21} - g_{11}^2 &= h_{01} h_{21} - h_{11}^2 \end{aligned} \quad (3.59)$$

suppose the convention of sign in second equation is taken as  $g_{21} = \eta h_{21}$ , and where  $\eta = \pm 1$ . Last two equations will be as,

$$\begin{aligned}
 h_{11} &= \frac{1}{h_{20}}(g_{20}g_{11} - \varphi g_{21}) \\
 g_{21}^2 &= 2\left(\frac{g_{20}g_{11}}{\varphi} + \frac{\theta}{\varphi^2}h_{20}^2\right)g_{21} - \frac{g_{11}^2}{\varphi^2}(g_{20}^2 - h_{20}^2)
 \end{aligned}
 \tag{3.60}$$

where  $\theta = g_{01} - \eta h_{01}$  and  $\varphi = g_{10} - \eta h_{10}$ , and the term  $\frac{g_{11}^2}{\varphi^2}(g_{20}^2 - h_{20}^2)$  in last equation is zero so the solutions for  $h_{11}$  and  $g_{21}$  can be obtained are,

$$\begin{aligned}
 g_{21} = 0 &\rightarrow h_{11} = \frac{g_{20}}{h_{20}}g_{11} \\
 g_{21} = \frac{2}{\varphi}(g_{20}g_{11} + \frac{\theta}{\varphi}h_{20}^2) &\rightarrow h_{11} = \frac{g_{20}}{h_{20}}g_{11}
 \end{aligned}
 \tag{3.61}$$

From 3.58 and 3.61 it can be noticed that the coefficients of two variable polynomials  $g$  and  $h$  are represented as the combinations of independent coefficients  $\{h_{01}, h_{10}, h_{20}\}$ . Figure 3.6(a) is showing the case of alternating connection of elements where  $g_{21} = 0$  and Figure 3.6(b) is showing the case with  $g_{21} \neq 0$ .

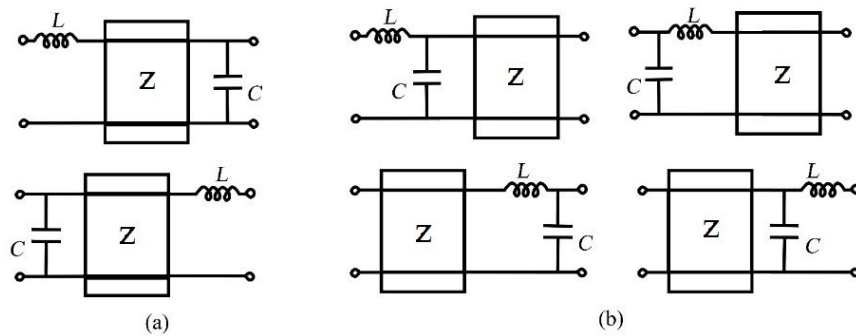

**Figure 3.6 LPLU Section of Degree Three.**

here, the negative and positive signs are a representation for capacitor and inductor respectively, but their values are always positive can be proved similarly to the previous section of LPLU of degree two.

- Suppose  $g(p, 0) = g_D$ ,  $f(p, 0) = f_D$  and  $h(p, 0) = h_D$ , also  $g(0, \lambda) = g_L$ ,  $f(0, \lambda) = f_L$  and  $h(0, \lambda) = h_L$  are notations for the representation of the boundary polynomials corresponding to the case  $p = 0$  and  $\lambda = 0$ . Form 3.66 and 3.67, we obtained following,
- **Case I ( $p = 0$ ):**

Since, the value of  $n_\lambda = 1$  so the results of  $f_D$ ,  $h_D$  and  $h_D$  will be same as shown by 3.55,

$$f_D = (1 - \lambda^2)^{\frac{1}{2}}, \quad g_D = 1 + g_{01}\lambda, \quad h_D = h_{01}\lambda, \quad (3.62)$$

where  $g_{01}^2 = 1 + h_{01}^2, \quad g_{01} > |h_{01}|$

these corelates with a UE of characteristic impedance  $R = g_{01} + h_{01} = 1/(g_{01} + h_{01}) > 0$ .

- **Case II ( $\lambda = 0$ ):**

$$f_L = 1, \quad g_L = 1 + g_{10}p + g_{20}p^2, \quad h_L = h_{01}p + h_{20}p^2, \quad (3.63)$$

where  $g_{10} = (h_{10}^2 + 2g_{20})^{1/2}, \quad h_{20} = \eta_1 g_{20} \quad \text{and} \quad \eta_1 = \pm 1$

It is clear from the impression that the structure is a second order lumped ladder. By applying matrix factorization technique (Aksen, 1994), the polynomial description of each element present in the ladder can be obtained easily. To do so, suppose the setting  $f_L = f_{L_1} = f_{L_2} = 1$  and bring the following decompositions of  $g_L$  and  $h_L$ .



$$f_{L_1} = 1, \quad g_{L_1} = 1 + G_1 p, \quad h_{L_1} = \eta_1 G_1 p,$$

$$\text{where} \quad G_1 = \frac{g_{20}}{g_{10} - \eta_1 h_{10}}$$

(3.64)

$$f_{L_2} = 1, \quad g_{L_2} = 1 + G_2 p, \quad h_{L_2} = -\eta_1 G_2 p,$$

$$\text{where} \quad G_2 = g_{10} - G_1$$

for  $\eta_1 = 1$  the inductor in first section is  $L = 2G_1$  and the capacitor in second section is  $C = 2G_2$  and vice versa for  $\eta_1 = -1$ , and once again it is clear that the values of  $C$  and  $L$  are positive.

If various cascade connections are made by using the sections  $[L_1]$ ,  $[L_2]$  and  $[D]$ , the outcoming two-variable polynomials will be same for the case  $p = 0$  and  $\lambda = 0$ , provided the occurrence order of  $[L_1]$  and  $[L_2]$  in the cascade remain conserved. The change will only occur for the coefficients  $g_{11}$ ,  $h_{11}$  and  $g_{21}$ ,  $h_{21}$  and can be checked readily by using 3.62 and 3.64. consider the example of an alternating connection of the sections like  $([L_1] [D] [L_2])$ , we get

$$g_{21} = h_{21} = 0, \quad g_{11} = g_{01}g_{10} - h_{01}h_{10}, \quad h_{11} = \frac{g_{20}}{h_{20}}g_{11} \quad (3.65)$$

These relations are same as the relations in 3.61 and the Figure 3.6(a) is covering the both case that  $[L_1]$  is and inductor or a capacitor. The correspondence between 3.61 and the Figure 3.6(b) can also be done in same fashion.

- **LPLU of Degree Four:**

Now Consider a two-variable polynomial with degree four so  $n_p = n_\lambda = 2$  and the polynomial  $f, g$  and  $h$  can be given by using similar method that is used earlier, as

$$f = 1 - \lambda^2, \quad g = g_0 + g_1 p + g_2 p^2, \quad h = h_0 + h_1 p + h_2 p^2, \quad (3.66)$$

where  $g_k = g_{k0} + g_{k1}\lambda + g_{k2}\lambda^2$ ,  $h_k = h_{k0} + h_{k1}\lambda + h_{k2}\lambda^2$ ,  
and  $k = 0,1$

By solving the relationship explained in 3.44 and 3.45, following expressions for  $g_{01}$  and  $g_{10}$  can be obtained Here an assumption is made again that  $g_{00} = 1$  and  $h_{00} = 0$  and  $h_{0k}$  and  $h_{k0}$  is taken as independent coefficients so, 3.52 helps to determine  $g_{0k}$  and  $g_{k0}$  as

$$\begin{aligned} g_{01} &= (2(1 + g_{02}) + h_{01}^2)^{1/2}, & g_{02} &= (1 + h_{02}^2)^{1/2} \\ g_{10} &= (2g_{02} + h_{02}^2)^{1/2}, & g_{20} &= |h_{20}| \end{aligned} \quad (3.67)$$

and remaining coefficients of polynomial  $g$  and  $h$  can be produced by using FES those are produced by 3.39 to 3.42. now consider the coefficients properties associated to LPLU structure in FES, a simplified set of equation can be written, that enables to find the unique solution for unknowns  $g_{kl}$  and  $h_{kl}$  and  $k, l \neq 0$ . In this case the restriction  $g_{22} = h_{22} = 0$ , leads us to following,

$$\begin{aligned} g_{12}^2 &= h_{12}^2 \\ g_{21}^2 &= h_{21}^2 \\ g_{12}g_{21} &= h_{12}h_{21} \\ g_{01}g_{10} - g_{11} &= h_{01}h_{10} \\ g_{10}g_{12} - g_{11}g_{20} &= h_{10}h_{12} - h_{02}h_{11} \\ 2(g_{10}g_{12} + g_{01}g_{21} - g_{20}g_{02}) - g_{11}^2 &= 2(h_{10}h_{12} + h_{01}h_{21} - h_{20}h_{02}) - h_{11}^2 \\ g_{11}g_{20} - g_{10}g_{21} &= h_{11}h_{20} - h_{10}h_{21} \end{aligned} \quad (3.68)$$

from first four equations the value of  $g_{12}$ ,  $g_{21}$  and  $g_{11}$  can be obtained and suppose the convention of sign in second equation is taken as  $g_{21} = \eta h_{21}$ , and where  $\eta = \pm 1$ . Last two equations will be as,

$$\begin{aligned}
g_{12} &= \frac{1}{\theta} (g_{02}g_{11} - h_{11}h_{02}) \\
g_{21} &= \frac{1}{\varphi} (g_{20}g_{11} - h_{11}h_{20}) \\
h_{11}^2 &= 2 \left( \frac{\varphi}{\theta} h_{02} + \frac{\theta}{\varphi} h_{20} \right) h_{11} - \left( \frac{\theta^2}{\varphi^2} h_{20}^2 + \frac{\varphi^2}{\theta^2} h_{02}^2 + 2h_{02}h_{20} \right)
\end{aligned} \tag{3.69}$$

where  $\theta = g_{01} - \eta h_{01}$  and  $\varphi = g_{10} - \eta h_{10}$ , and the in last equation is a pure quadratic equation so a unique solution for  $h_{11}$  can be obtained,

$$h_{11} = \frac{\varphi}{\theta} h_{02} + \frac{\theta}{\varphi} h_{20} \tag{3.70}$$

From 3.67, 3.68 and first four equations of 3.69 and 3.70 that is also obtained from 3.69 is required solution set of our FES and represented as the combinations of independents coefficients  $\{h_{01}, h_{10}, h_{20}\}$ . Figure 3.7 is showing the LPLU realization of degree four.

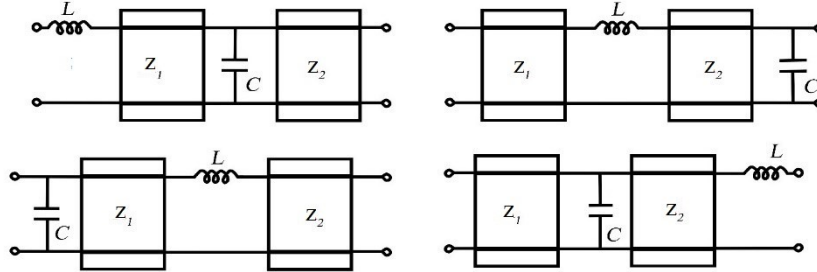

**Figure 3.7 LPLU Section of Degree Four.**

The above unique solution is satisfying the FES and all the general properties related to low-pass ladders structures with UEs. Here, the negative and positive signs are a representation for capacitor and inductor respectively, but their values are always positive can be proved similarly to the previous section of LPLU of degree two.

- Suppose  $g(p, 0) = g_D$ ,  $f(p, 0) = f_D$  and  $h(p, 0) = h_D$ , also  $g(0, \lambda) = g_L$ ,  $f(0, \lambda) = f_L$  and  $h(0, \lambda) = h_L$  are notations for the representation of the

boundary polynomials corresponding to the case  $p = 0$  and  $\lambda = 0$ . Form 3.66 and 3.67, we obtained following,

- **Case I ( $p = 0$ ):**

Since, the value of  $n_\lambda = 2$  so the results of  $f_D, h_D$  and  $g_D$  will be as,

$$f_D = 1 - \lambda^2, \quad g_D = 1 + g_{01}\lambda + g_{02}\lambda^2, \quad h_D = h_{01}\lambda + h_{02}\lambda^2, \quad (3.71)$$

where  $g_{01} = (2(1 + g_{02}) + h_{01}^2)^{\frac{1}{2}}, \quad g_{02} = (1 + h_{01}^2)^{1/2}$

By following the factorization of transfer matrix method (Aksen, 1994) the decomposition of the polynomials gives,

$$f_{D_1} = (1 - \lambda^2)^{1/2}, \quad g_{D_1} = 1 + G'_1\lambda, \quad h_{D_1} = H'_1\lambda, \quad (3.72)$$

where  $G'_1 = \frac{g_{10}}{2} + \frac{h_{10}h_{20}}{2(1 + g_{20})}, \quad H'_1 = \frac{h_{10}}{2} + \frac{g_{10}h_{20}}{2(1 + g_{20})}$

$$f_{D_2} = (1 - \lambda^2)^{1/2}, \quad g_{D_2} = 1 + G'_2\lambda, \quad h_{D_2} = H'_2\lambda,$$

where  $G'_2 = \frac{g_{10}}{2} - \frac{h_{10}h_{20}}{2(1 + g_{20})}, \quad H'_2 = \frac{h_{10}}{2} - \frac{g_{10}h_{20}}{2(1 + g_{20})}$

here, the decomposition is applied in such a way that following expression are satisfied,

$$G_1'^2 = H_1'^2 + 1 \text{ and } G_2'^2 = H_2'^2 + 1$$

By using these constraints with the polynomial from 3.72, the characteristic impedance  $Z_1$  and  $Z_2$  can be given as,

$$Z_k = G'_k + H'_k = 1/(G'_k + H'_k) > 0, \quad k = 1,2 \quad (3.73)$$

- **Case II ( $\lambda = 0$ ):**

As the value of  $n_p = 2$  so the case is exactly same as discussed in degree three with  $\lambda = 0$  so,

$$f_L = 1, \quad g_L = 1 + g_{10}p + g_{20}p^2, \quad h_L = h_{01}p + h_{20}p^2, \\ \text{where } g_{10} = (h_{10}^2 + 2g_{20})^{1/2}, \quad h_{20} = \eta_1 g_{20} \quad \text{and } \eta_1 = \pm 1 \quad (3.74)$$

It is clear from the impression that the structure is a second order lumped ladder. By applying matrix factorization technique (Aksen, 1994), the polynomial description of each element present in the ladder can be obtained easily. To do so, suppose the setting  $f_L = f_{L_1} = f_{L_2} = 1$  and bring the following decompositions of  $g_L$  and  $h_L$ .

$$f_{L_1} = 1, \quad g_{L_1} = 1 + G_1p, \quad h_{L_1} = \eta_1 G_1p, \\ \text{where } G_1 = \frac{g_{20}}{g_{10} - \eta_1 h_{10}} \quad (3.75)$$

$$f_{L_2} = 1, \quad g_{L_2} = 1 + G_2p, \quad h_{L_2} = -\eta_1 G_2p, \\ \text{where } G_2 = g_{10} - G_1$$

for  $\eta_1 = 1$  the inductor in first section is  $L = 2G_1$  and the capacitor in second section is  $C = 2G_2$  and vice versa for  $\eta_1 = -1$ , and once again it is clear that the values of  $C$  and  $L$  are positive.

cascade connections are made by using the sections  $[L_1] [D_1] [L_2] [D_2]$  and  $[D_1] [L_1] [D_2] [L_2]$  are describing the polynomials in 3.68. It is obvious that these to configurations are depending on the unimodular sign constant  $\eta$ .

- **LPLU of Degree Five:**

Now Consider a two-variable polynomial with degree four so  $n_p = 3$ ,  $n_\lambda = 2$  and the polynomial  $f, g$  and  $h$  can be given by using similar method that is used earlier, as

$$f = 1 - \lambda^2, g = g_0 + g_1p + g_2p^2 + g_3p^3, h = h_0 + h_1p + h_2p^2 + h_3p^3,$$

$$\text{where } g_k = g_{k0} + g_{k1}\lambda + g_{k2}\lambda^2, h_k = h_{k0} + h_{k1}\lambda + h_{k2}\lambda^2, \quad (3.76)$$

$$\text{and } k = 0,1,2$$

By solving the relationship explained in 3.44 and 3.45, following expressions for  $g_{01}$  and  $g_{10}$  can be obtained Here an assumption is made again that  $g_{00} = 1$  and  $h_{00} = 0$  and  $h_{0k}$  and  $h_{k0}$  is taken as independent coefficients so, 3.52 helps to determine  $g_{0k}$  and  $g_{k0}$  as

$$\begin{aligned} g_{01} &= (2(1 + g_{02}) + h_{01}^2)^{\frac{1}{2}}, & g_{02} &= (1 + h_{02}^2)^{\frac{1}{2}} \\ g_{10} &= (2g_{02} + h_{02}^2)^{\frac{1}{2}}, & g_{20} &= (h_{02}^2 + 2g_{10}g_{30} - 2h_{10}h_{30})^{\frac{1}{2}} \\ g_{30} &= |h_{30}| \end{aligned} \quad (3.77)$$

and remaining coefficients of polynomial  $g$  and  $h$  can be produced by using FES those are produced by 3.39 to 3.42. now consider the coefficients properties associated to LPLU structure in FES, a simplified set of equation can be written, that enables to find the unique solution for unknowns  $g_{kl}$  and  $h_{kl}$  and  $k, l \neq 0$ . In this case the restriction  $g_{22} = h_{22} = g_{32} = h_{32} = g_{31} = h_{31} = 0$ , leads us to following,

$$\begin{aligned} g_{01}g_{10} - g_{11} &= h_{01}h_{10} \\ g_{12}^2 &= h_{12}^2 \\ g_{12}g_{21} &= h_{12}h_{21} \\ g_{21}g_{30} &= h_{21}h_{30} \end{aligned} \quad (3.78)$$

$$\begin{aligned}
2g_{21}g_{30} + g_{21}^2 &= 2h_{21}h_{30} + h_{21}^2 \\
g_{01}g_{12} - g_{11}g_{02} &= h_{01}h_{12} - h_{02}h_{11} \\
g_{11}g_{20} - g_{10}g_{21} - g_{01}g_{30} &= h_{11}h_{20} - h_{10}h_{21} - h_{01}h_{30} \\
2(g_{10}g_{12} + g_{01}g_{21} - g_{20}g_{02}) - g_{11}^2 &= 2(h_{10}h_{12} + h_{01}h_{21} - h_{20}h_{02}) - h_{11}^2
\end{aligned}$$

From first four equations the value of  $g_{12}$ ,  $g_{21}$  and  $g_{11}$  can be obtained very simply i.e.  $g_{21} = \eta h_{21}$ , where  $\eta = \frac{g_{30}}{h_{30}} = \pm 1$ . From remaining equations and with some substitution from prior study following can be extracted and given as,

$$\begin{aligned}
h_{11} &= \frac{\varphi}{\theta} h_{02} + \frac{\theta}{\varphi} h_{20} \\
g_{12} &= \frac{1}{\theta} (g_{02}g_{11} - h_{11}h_{02}) \\
g_{21} &= \frac{1}{\varphi} (g_{20}g_{11} - h_{11}h_{20} - g_{01}g_{30} + h_{01}h_{30})
\end{aligned} \tag{3.79}$$

where  $\theta = g_{01} - \eta h_{01}$  and  $\varphi = g_{10} - \eta h_{10}$ , and it can be noticed that  $\eta = \pm \frac{g_{30}}{h_{30}}$ , is having a unique definition and the values of the polynomials  $g$  and  $h$  obtained by this way, both topological characterizations are given in Figure 3.8 and the difference between these two configurations is the sign of free parameter  $h_{30}$ . By making alternating connections of elements, it can be proved easily. These connections are taken from the lumped and distributed two-port characterized by the polynomial corresponding to the case  $p = 0$  and  $\lambda = 0$ .

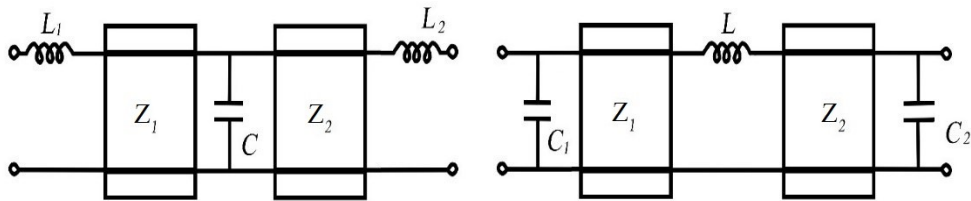

**Figure 3.8 LPLU Section of Degree Five.**

Suppose  $g(p, 0) = g_D$ ,  $f(p, 0) = f_D$  and  $h(p, 0) = h_D$ , also  $g(0, \lambda) = g_L$ ,  $f(0, \lambda) = f_L$  and  $h(0, \lambda) = h_L$  are notations for the representation of the boundary polynomials corresponding to the case  $p = 0$  and  $\lambda = 0$ . Form 3.76 and 3.77, we obtained following,

- **Case I ( $p = 0$ ):**

Since, the value of  $n_\lambda = 2$  so the results of  $f_D, h_D$  and  $h_D$  will be as,

$$f_D = 1 - \lambda^2, \quad g_D = 1 + g_{01}\lambda + g_{02}\lambda^2, \quad h_D = h_{01}\lambda + h_{02}\lambda^2, \quad (3.80)$$

where  $g_{01} = (2(1 + g_{02}) + h_{01}^2)^{\frac{1}{2}}, \quad g_{02} = (1 + h_{01}^2)^{1/2}$

By following the factorization of transfer matrix method (Aksen, 1994) the decomposition of the polynomials gives,

$$f_{D_1} = (1 - \lambda^2)^{1/2}, \quad g_{D_1} = 1 + G'_1\lambda, \quad h_{D_1} = H'_1\lambda, \quad (3.81)$$

where  $G'_1 = \frac{g_{10}}{2} + \frac{h_{10}h_{20}}{2(1 + g_{20})}, \quad H'_1 = \frac{h_{10}}{2} + \frac{g_{10}h_{20}}{2(1 + g_{20})}$

$$f_{D_2} = (1 - \lambda^2)^{1/2}, \quad g_{D_2} = 1 + G'_2\lambda, \quad h_{D_2} = H'_2\lambda,$$

where  $G'_2 = \frac{g_{10}}{2} - \frac{h_{10}h_{20}}{2(1 + g_{20})}, \quad H'_2 = \frac{h_{10}}{2} - \frac{g_{10}h_{20}}{2(1 + g_{20})}$

here, the decomposition is applied in such a way that following expression are satisfied,

$$G_1'^2 = H_1'^2 + 1 \text{ and } G_2'^2 = H_2'^2 + 1$$

By using these constraints with the polynomial from 3.72, the characteristic impedance  $Z_1$  and  $Z_2$  can be given as,

$$Z_k = G_k' + H_k' = 1/(G_k' + H_k') > 0, \quad k = 1, 2 \quad (3.82)$$



- **Case II ( $\lambda = 0$ ):**

As the value of  $n_p = 3$  so the case will be with degree three and with  $\lambda = 0$  so,

$$\begin{aligned} f_L &= 1, & g_L &= 1 + g_{10}p + g_{20}p^2 + g_{30}p^3, \\ h_L &= h_{01}p + h_{20}p^2 + h_{30}p^3, \end{aligned}$$

where

(3.83)

$$g_{10}^2 = h_{10}^2 + 2g_{20}, \quad g_{20}^2 = h_{20}^2 + 2g_{10}g_{30} - 2g_{10}g_{30}$$

$$\text{and} \quad g_{30} = |h_{30}|$$

It is clear and readily confirmed from the impression  $g_L$  is strictly Hurwitz and contains positive coefficients. By applying matrix factorization technique (Aksen, 1994), the polynomial description of each element present in the ladder can be obtained easily. The sign convention between  $g_L$  and  $h_L$  can be written by the expression  $\eta = \frac{g_{30}}{h_{30}} = \pm 1$ . To implement this, suppose the setting  $f_L = f_{L_1} = f_{L_2} = 1$  and bring the following decompositions of  $g_L$  and  $h_L$ .

$$f_{L_1} = 1, \quad g_{L_1} = 1 + G_1p, \quad h_{L_1} = \eta G_1p,$$

$$f_{L_2} = 1, \quad g_{L_2} = 1 + G_2p, \quad h_{L_2} = -\eta G_2p,$$

$$f_{L_3} = 1, \quad g_{L_3} = 1 + G_3p, \quad h_{L_3} = \eta G_3p,$$

(3.84)

$$\text{where} \quad G_1 = \frac{g_{30}}{g_{20} - \eta h_{20}}, \quad G_2 = \frac{g_{20} - G_1(g_{10} - h_{10})}{g_{10} - G_1 + \eta(h_{10} - \eta G_1)},$$

$$\text{and} \quad G_3 = g_{10} - G_1 - G_2$$

for  $\eta = 1$  the inductor in first section is  $L = 2G_k$  and the capacitor in second section is  $C = 2G_k$  and vice versa for  $\eta = -1$ , and once again it is clear that the values of  $C$  and  $L$  are positive.

cascade connections are made by using the sections  $[L_1] [D_1] [L_2] [D_2] [L_3]$  and  $[D_1] [L_1] [D_2] [L_2] [D_3]$  are describing the polynomials in 3.68. It is obvious that these two configurations are depending on the unimodular sign constant  $\eta$ .

### 3.2.2.2 Construction of High Order Ladders

In the previous section, fundamental equation set of basic ladder structures up to degree five are solved to find the explicit results of canonic polynomial directly. With increase in the degree of the ladder structure the problem complex and solving FES become very difficult.

Now consider the case where  $n_p + n_\lambda \geq 5$ , precisely,  $n_p = m + 1$ ,  $n_\lambda = m$  and with the help of matrices representation in 3.49 the number of nonzero coefficients in  $g$  will be  $m(m + 1)/2 + 2(m + 1)$  also in  $h$ . From previous discussion it can be seen that  $2(m + 1)$  coefficients in  $h$  can be chosen independently, also defines  $2(m + 1)$  coefficients in  $g$  properly. Paraunitary condition will decrease the number of equations to  $N_e = m(m + 1)$  with number of unknowns  $N_u = m(m + 1)$ . On the other hand, under consideration ladder with recursive topology requires  $m$  coefficients of  $h$  are related to  $m$  coefficients  $g$  reach with in a sign change. In this situation the number of unknown will be reduced to  $N_u = m^2$  and FES will be overdetermined, and the solution will not be the unique solution for case  $m > 2$ . It is obvious to find unique solution,  $N_u + N_e = m$  additional constraints are required on the coefficients. There is a possibility to find a numerical solution by using numerical tools, but it will also be very hard because to guarantee the realizability of obtained network function, it is necessary to assure the Hurwitzness of  $g$  during the entire process of numerical analysis. So, other means of constructing higher order polynomial must be considered.

A direct approach to construct high degree polynomial can be consider that is to cascade the elementary LPLU segments, one which are already have explicit representation. Explicit representation of LPLU up to degree five have been already discussed and in each case two are more configurations are presented. By using two these low order and cascade them we may have a higher order LPLU with distinguished realization by this method the degree of freedom for resulting structure can be enhanced. It seems natural that by using several fundamental

segments in arbitrary or prescribed pattern to make high order low-pass structures. By this method the structures shown in Figure 3.9 can be made, where second order configuration of lumped or distributed segments are cascaded. Uncontrolled or degenerated case is expressed like a case where two inductors are connected shown in Figure 3.9(c) this would rise the problem of reduction in degree of the polynomial. This problem can be tackled by using the controlled cascading of elementary elements.

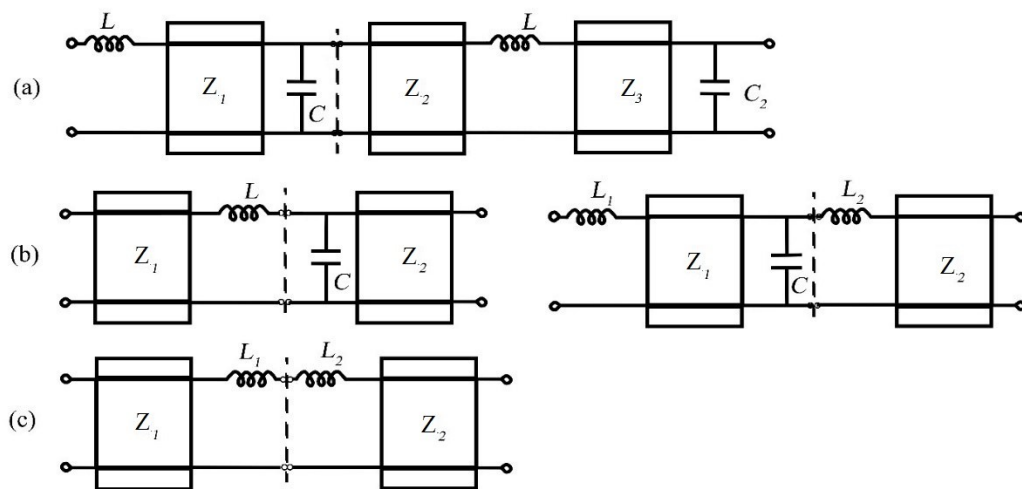

**Figure 3.9 Higher Order LPLUs as Cascades of Elementary LPLU Section.**

## 4 PROPOSED APPROACH TO FIND ANALYTICAL SOLUTION FOR LPLU OF DEGREE FIVE

In this chapter, we will focus to find the analytical solutions for LPLU of degree five some real and realizable values. We will generate a two-variable polynomial with degree five by using the steps studied in the previous chapter and furthermore two cases will be discussed further exist within LPLU of five.

### 4.1 Problem Statement:

The problem encountered, is how to use the algorithm known as “*Standard Decomposition Technique (SDT)*” to find the analytical solutions for “*Fundamental equation set (FES)*” obtained by using Belevitch canonic polynomial “ $g(p, \lambda)$ ,  $h(p, \lambda)$  and  $f(p, \lambda)$ ” for mixed lumped and distributed lossless two-port cascaded networks in two variables and use the extracted solutions in synthesis of realizable networks. The problem can also be classified into two cases, first is with three lumped and two distributed ( $n_p = 3, n_\lambda = 2$ ) and the second will be with three distributed and two lumped important ( $n_p = 3, n_\lambda = 2$ ).

### 4.2 Explicit Solution for LPLU of Degree Five:

#### 4.2.1 Case-I (Three Lumped and Two Distributed ( $n_p = 3, n_\lambda = 2$ ))

Now consider a two-variable polynomial with degree five so  $n_p = 3, n_\lambda = 2$  and the polynomial  $f, g$  and  $h$  can be given, by using earlier discussion as

$$\begin{aligned}
 f(p, \lambda) &= 1 - \lambda^2, \\
 g(p, \lambda) &= g_{00} + g_{01}\lambda + g_{02}\lambda^2 + g_{10}p + g_{11}\lambda p + g_{12}\lambda^2 p + \\
 &\quad g_{20}p^2 + g_{21}p^2\lambda + g_{30}p^3 \\
 h(p, \lambda) &= h_{00} + h_{01}\lambda + h_{02}\lambda^2 + h_{10}p + h_{11}\lambda p + h_{12}\lambda^2 p + \\
 &\quad h_{20}p^2 + h_{21}p^2\lambda + h_{30}p^3
 \end{aligned} \tag{4.1}$$

it is also known that,

$$g(p, \lambda)g(-p, -\lambda) = f(p, \lambda)f(-p, -\lambda) + h(p, \lambda)h(-p, -\lambda) \quad (4.2)$$

assume  $g_{00} = 1$  and  $h_{00} = 0$  and then by making substitution of 4.1 in 4.2 and comparing the coefficients the required fundamental equation set (FES) can be obtained cans in this case it will be,

$$h_{12}^2 - g_{12}^2 = 0 \quad (4.3)$$

$$g_{02}^2 - h_{02}^2 - 1 = 0 \quad (4.4)$$

$$2h_{12}h_{21} - 2g_{12}g_{21} = 0 \quad (4.5)$$

$$2h_{01}h_{12} - 2h_{02}h_{11} + 2g_{02}g_{11} - 2g_{01}g_{12} = 0 \quad (4.6)$$

$$g_{11}^2 - h_{11}^2 - 2g_{01}g_{21} + 2g_{02}g_{20} - 2g_{10}g_{12} + 2h_{01}h_{21} - 2h_{02}h_{20} + 2h_{12}h_{10} = 0 \quad (4.7)$$

$$-g_{01}^2 + h_{01}^2 + 2g_{02} + 2 = 0 \quad (4.8)$$

$$2h_{30}h_{21} - 2g_{30}g_{21} = 0 \quad (4.9)$$

$$2g_{11}g_{20} - 2g_{10}g_{21} - 2g_{30}g_{01} + 2h_{30}h_{01} + 2h_{10}h_{21} - 2h_{11}h_{20} = 0 \quad (4.10)$$

$$2g_{11} - 2g_{10}g_{01} + 2h_{10}h_{01} = 0 \quad (4.11)$$

$$h_{30}^2 - g_{30}^2 = 0 \quad (4.12)$$

$$g_{20}^2 - h_{20}^2 - 2g_{30}g_{10} + 2h_{30}h_{10} = 0 \quad (4.13)$$

$$-g_{10}^2 + h_{10}^2 + 2g_{20} = 0 \quad (4.14)$$

by solving expression 4.4 and expression 4.9, we can obtain the values of  $g_{01}$  and  $g_{02}$  as given

$$g_{01} = (2(1 + g_{02}) + h_{01}^2)^{\frac{1}{2}}, \quad g_{02} = (1 + h_{02}^2)^{\frac{1}{2}} \quad (4.15)$$

Similarly, by solving expression 4.14 and 4.13 we can obtain the values of  $g_{10}$  and  $g_{20}$  as given

$$g_{10} = (2g_{02} + h_{02}^2)^{\frac{1}{2}}, \quad g_{20} = (h_{02}^2 + 2g_{10}g_{30} - 2h_{10}h_{30})^{\frac{1}{2}} \quad (4.16)$$

by solving expression 4.12 gives,

$$g_{30} = |h_{30}| \quad (4.17)$$

by solving expression 4.11 can give,

$$g_{11} = g_{10}g_{01} - h_{10}h_{01} \quad (4.18)$$

and remaining coefficients of polynomial  $g$  and  $h$  can be produced by using remaining expression from 4.3 to 4.7 presented as of FES with the restriction  $g_{22} = h_{22} = g_{32} = h_{32} = g_{31} = h_{31} = 0$ , the value of  $g_{12}$ ,  $g_{21}$ ,  $h_{12}$ ,  $h_{21}$  and  $h_{11}$  can be obtained in a very simple way by choosing the expressions from FES wisely. From remaining equations and with some substitution from prior study following can be extracted and given as,

$$\begin{aligned} h_{11} &= \frac{\varphi}{\theta} h_{02} + \frac{\theta}{\varphi} h_{20} \\ g_{12} &= \frac{1}{\theta} (g_{02}g_{11} - h_{11}h_{02}) \\ g_{21} &= \frac{1}{\varphi} (g_{20}g_{11} - h_{11}h_{20} - g_{01}g_{30} + h_{01}h_{30}) \\ h_{21} &= \eta g_{21} \\ h_{12} &= g_{12}g_{21}/h_{21} \end{aligned} \quad (4.19)$$

where  $\theta = g_{01} - \eta h_{01}$  and  $\varphi = g_{10} - \eta h_{10}$ , and it can be noticed that  $\eta = \pm 1$  is having a unique definition and the values of the polynomials  $g$  and  $h$  obtained by this method.

Now by placing the values of independent variables  $\{h_{01} = 1.7310, h_{02} = -1.6281, h_{10} = 0.1042, h_{20} = 0.1827, h_{03} = -0.9960\}$  the coefficient matrices  $\mathbf{A}_g$  and  $\mathbf{A}_h$  can be obtained easily and the results are given as follows. Matlab code is used to implement these steps to find the solution and this code is presented at the end of the novel.

$$\begin{aligned} \mathbf{A}_g &= \begin{bmatrix} 1 & 2.96950 & 1.91070 \\ 2.03960 & 5.87620 & 2.27010 \\ 2.07460 & 3.53170 & 0 \\ 0.99600 & 0 & 0 \end{bmatrix}, \\ \mathbf{A}_h &= \begin{bmatrix} 0 & 1.7310 & -1.6281 \\ 0.1042 & -0.3420 & -2.2701 \\ 0.1827 & -3.5317 & 0 \\ -0.9960 & 0 & 0 \end{bmatrix} \end{aligned} \quad (4.20)$$

The coefficient matrices  $\mathbf{A}_g$  and  $\mathbf{A}_h$  are representing an explicit solution for case-I with three lumped and two distributed ( $n_p = 3, n_\lambda = 2$ ). The physical realization corresponding to the obtained solution in expression 4.20 can also be interpreted and given in Figure 4.1 (ŞENGÜL, JANUARY 2008) (AYDOĞAR, n.d.).

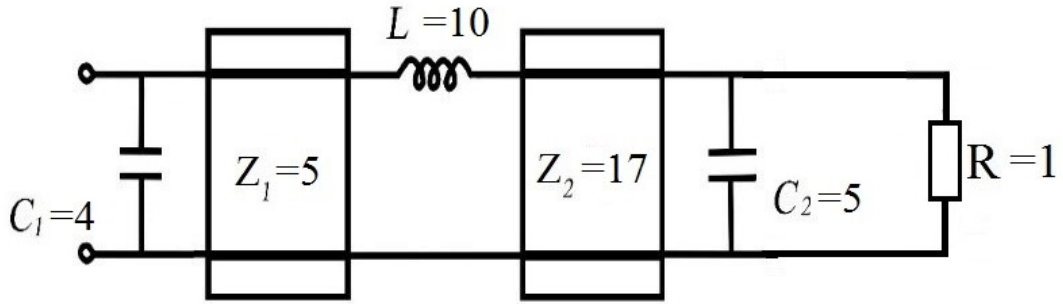

Figure 4.1 Physical Realization of LPLU Section of Degree Five ( $n_p = 3, n_\lambda = 2$ ).

#### 4.2.2 Case-II (Three Distributed and Two Lumped ( $n_\lambda = 3, n_p = 2$ ))

Now Consider a two-variable polynomial with degree five in such a way that the values of  $n_\lambda = 3, n_p = 2$  and the polynomial  $f, g$  and  $h$  can be given similarly as above,

$$\begin{aligned}
 f(p, \lambda) &= (1 - \lambda^2)^{3/2}, \\
 g(p, \lambda) &= g_{00} + g_{01}\lambda + g_{02}\lambda^2 + g_{03}\lambda^3 + g_{10}p + g_{11}\lambda p + g_{12}\lambda^2 p + \\
 &\quad g_{13}\lambda^3 p + g_{20}p^2 + g_{21}p^2 \lambda + g_{22}p^2 \lambda^2 + g_{23}p^2 \lambda^3 \\
 h(p, \lambda) &= h_{00} + h_{01}\lambda + h_{02}\lambda^2 + h_{03}\lambda^3 + h_{10}p + h_{11}\lambda p + h_{12}\lambda^2 p + \\
 &\quad g_{13}\lambda^3 p + h_{20}p^2 + h_{21}p^2 \lambda + h_{22}p^2 \lambda^2 + h_{23}p^2 \lambda^3
 \end{aligned} \tag{4.21}$$

it is also known that,

$$g(p, \lambda)g(-p, -\lambda) = f(p, \lambda)f(-p, -\lambda) + h(p, \lambda)h(-p, -\lambda) \tag{4.22}$$

assume  $g_{00} = 1$  and  $h_{00} = 0$  and then by making substitution of 4.21 in 4.22 and by comparing the coefficients of resultant after the substitution, the required fundamental equation set (FES) can be obtained and in this case it will be shown in ,

$$h_{23}^2 - g_{23}^2 = 0 \quad (4.23)$$

$$g_{13}^2 - h_{13}^2 - 2g_{03}g_{23} - 2h_{03}h_{23} = 0 \quad (4.24)$$

$$g_{03}^2 + h_{03}^2 + 1 = 0 \quad (4.25)$$

$$2g_{13}g_{22} - 2g_{12}g_{23} + 2h_{12}h_{23} - 2h_{13}h_{22} = 0 \quad (4.26)$$

$$2g_{13}g_{02} - 2g_{12}g_{03} + 2h_{12}h_{03} + 2h_{13}h_{02} = 0 \quad (4.27)$$

$$g_{22}^2 - h_{22}^2 - 2g_{21}g_{23} + 2h_{21}h_{23} = 0 \quad (4.28)$$

$$h_{12}^2 - g_{12}^2 - 2g_{01}g_{23} + 2g_{02}g_{22} - 2g_{03}g_{21} + 2g_{11}g_{13} + 2h_{01}h_{23} - 2h_{02}h_{22} + 2h_{03}h_{21} - 2h_{11}h_{13} = 0 \quad (4.29)$$

$$g_{02}^2 - h_{02}^2 - 2g_{03}g_{01} + 2h_{03}h_{01} - 3 = 0 \quad (4.30)$$

$$2g_{11}g_{22} - 2g_{10}g_{23} - 2g_{12}g_{21} + 2g_{20}g_{13} + 2h_{10}h_{23} - 2h_{11}h_{22} + 2h_{12}h_{21} - 2h_{20}h_{13} = 0 \quad (4.31)$$

$$2g_{13} - 2g_{01}g_{12} + 2g_{02}g_{11} - 2g_{03}g_{10} + 2h_{01}h_{12} + 2h_{02}h_{11} - 2h_{03}h_{10} = 0 \quad (4.32)$$

$$-g_{21}^2 + h_{21}^2 + 2g_{20}g_{22} - 2h_{20}h_{22} = 0 \quad (4.33)$$

$$h_{11}^2 - g_{11}^2 + 2g_{22} - 2g_{01}g_{21} - 2g_{02}g_{20} + 2g_{10}g_{12} + 2h_{01}h_{21} - 2h_{02}h_{20} + 2h_{10}h_{12} = 0 \quad (4.34)$$

$$-g_{01}^2 + h_{01}^2 + 2g_{02} + 3 = 0 \quad (4.35)$$

$$2g_{11}g_{20} - 2g_{10}g_{21} + 2h_{10}h_{21} - 2h_{11}h_{20} = 0 \quad (4.36)$$

$$2g_{11} - 2g_{10}g_{01} + 2h_{10}h_{01} = 0 \quad (4.37)$$

$$g_{20}^2 - h_{20}^2 = 0 \quad (4.38)$$

$$-g_{10}^2 + h_{10}^2 + 2g_{20} = 0 \quad (4.39)$$

by solving expression 4.25 gives  $g_{03}$ ,

$$g_{03} = |(1 + h_{03})^{1/2}| \quad (4.40)$$

solution of the expression 4.38 for  $g_{20}$  is,

$$g_{20} = |h_{20}| \quad (4.41)$$



solution of the expression 4.39 for  $g_{10}$  is,

$$g_{10} = |(h_{10}^2 + 2g_{20})^{1/2}| \quad (4.42)$$

by solving expression 4.30 and 4.35 of FES. we can obtain the values of  $g_{01}$  and  $g_{02}$  as given

$$g_{01} = |(h_{01}^2 + 2g_{02} + 3)^{\frac{1}{2}}|, \quad g_{02} = |(h_{02}^2 + 2g_{03}g_{01} - 2h_{03}h_{01} + 3)^{\frac{1}{2}}| \quad (4.43)$$

Clearly, it can be noticed that expression 4.43 consists of two unknowns with two equation and with simple algebra or any symbolic solver of any suitable computer program can solve it to obtain the desired result, we have used Matlab built in function solve() to find the solutions of our problems analytically.

Now by solving expression 4.37 gives  $g_{11}$ ,

$$g_{11} = |g_{10}g_{01} - h_{10}h_{01}| \quad (4.44)$$

until now,6 unknowns have successfully obtained and remain part is tricky, so some equations are simplified and substituted in others to make ease to achieve the desired results. Now substitute the obtained values in equation 4.24 and 4.28 the result will be two very simple equations as follow,

$$g_{13} = |h_{13}|, \quad \text{and} \quad g_{22} = |h_{22}| \quad (4.45)$$

Now remaining unknowns are  $g_{12}$ ,  $g_{21}$ ,  $h_{11}$ ,  $h_{12}$ ,  $h_{13}$ ,  $h_{21}$  and  $h_{22}$  and can be obtained by simplifying and reducing FES to workable set of equation for this purpose, substitute the values of 4.40 to 4.45 expression number 4.27, 4.29, 4.31, 4.32, 4.33, 4.34, 4.36 and restriction  $g_{32} = h_{32} = 0$ , we will get following,

$$\begin{aligned}
Ah_{13} - Bg_{12} + Ch_{12} &= 0 \\
h_{12}^2 - g_{12}^2 + Ig_{22} - Dg_{21} + Eh_{13} + Fh_{21} + Gh_{22} - 2h_{11}h_{13} &= 0 \\
Hh_{13} + Ih_{22} - 2g_{12}g_{21} - 2h_{11}h_{22} + 2h_{12}h_{21} &= 0 \\
Jh_{11} - Kg_{12} + Mh_{12} + Nh_{13} + \text{constant} &= 0 \\
-g_{21}^2 + h_{21}^2 + Hh_{22} &= 0 \\
-h_{11}^2 - Og_{12} - Pg_{21} + 2h_{12} + Qh_{21} + 2h_{22} + \text{constant} &= 0 \\
Hh_{11}/2 - Rg_{21} + 2h_{21} + \text{constant} &= 0
\end{aligned} \tag{4.46}$$

In 4.46 the coefficients A to R and constant are used to keep the expressions in simple and understandable and the values of the coefficients and constants are strictly depending upon the obtained numerical values of unknowns from 4.40 to 4.45. It can be seen clearly that we have seven unknowns and seven number of equation so the explicit solution of these expression in 4.46 is readily possible. Still it requires a huge algebraic manipulation to reach the final results, to avoid all that process of calculation MATLAB's analytical solver by the name of solve() can be used to get the required results. A successful detailed Matlab code is provided to solve this problem at the end of the dissertation.

Results can be checked by placing the real values of independent variables  $\{h_{01} = 5.5416, h_{02} = -1.6667, h_{03} = 0.2917, h_{10} = -2.0000, h_{20} = 22.5\}$  and more than one explicit solution are obtained for the coefficient matrices  $\mathbf{A}_g$  and  $\mathbf{A}_h$  and the results are fully satisfying the FES are given as follows. Number of solution are varying for every new input values.

In this case we have obtained four number of solutions and given as follows,

- **Solution-I:**

$$\begin{aligned}
\mathbf{A}_g &= \begin{bmatrix} 1 & 6.4583 & 4.0000 & 1.0417 \\ 7.0000 & 56.2911 & 109.8036 & 15.2310 \\ 22.5000 & 225.7115 & 33.9288 & 0 \end{bmatrix}, \\
\mathbf{A}_h &= \begin{bmatrix} 0 & 5.5416 & -1.6667 & 0.2917 \\ -2.0000 & -33.9535 & 96.2321 & 15.2310 \\ 22.5000 & 225.7115 & 33.9288 & 0 \end{bmatrix}
\end{aligned} \tag{4.20}$$

- **Solution-II:**

$$\begin{aligned} \mathbf{A}_g &= \begin{bmatrix} 1 & 6.4583 & 4.0000 & 1.0417 \\ 7.0000 & 56.2911 & 39.6664 & 7.8751 \\ 22.5000 & 0 & 127.4971 & 0 \end{bmatrix}, \\ \mathbf{A}_h &= \begin{bmatrix} 0 & 5.5416 & -1.6667 & 0.2917 \\ -2.0000 & 56.2911 & -11.3333 & 7.8751 \\ 22.5000 & 0 & 127.4971 & 0 \end{bmatrix} \end{aligned} \quad (4.21)$$

- **Solution-III:**

$$\begin{aligned} \mathbf{A}_g &= \begin{bmatrix} 1 & 6.4583 & 4.0000 & 1.0417 \\ 7.0000 & 56.2911 & 107.6663 & 37.0887 \\ 22.5000 & 235.4613 & 462.8180 & 0 \end{bmatrix}, \\ \mathbf{A}_h &= \begin{bmatrix} 0 & 5.5416 & -1.6667 & 0.2917 \\ -2.0000 & -27.4012 & 87.8142 & -37.0887 \\ 22.5000 & 117.4240 & -462.818 & 0 \end{bmatrix} \end{aligned} \quad (4.22)$$

- **Solution-IV:**

$$\begin{aligned} \mathbf{A}_g &= \begin{bmatrix} 1 & 6.4583 & 4.0000 & 1.0417 \\ 7.0000 & 56.2911 & 158.9884 & 54.6088 \\ 22.5000 & 100.0465 & 44.1968 & 0 \end{bmatrix}, \\ \mathbf{A}_h &= \begin{bmatrix} 0 & 5.5416 & -1.6667 & 0.2917 \\ -2.0000 & 18.2621 & 130.6256 & -54.6088 \\ 22.5000 & 77.6633 & -44.1968 & 0 \end{bmatrix} \end{aligned} \quad (4.23)$$

The coefficient matrices  $\mathbf{A}_g$  and  $\mathbf{A}_h$  are representing explicit solution for case-II with two lumped and three distributed ( $n_p = 2$ ,  $n_\lambda = 3$ ). The physical realization corresponding to the obtained solution in expression 4.20 can also be interpreted and given in Figure 4.2 (ŞENGÜL, JANUARY 2008) (AYDOĞAR, n.d.).

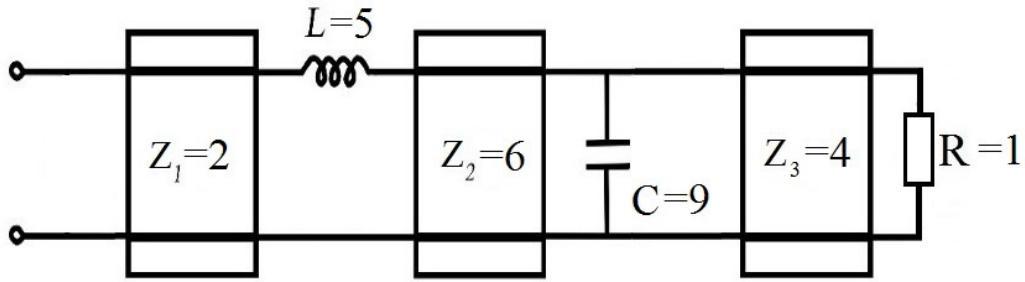

**Figure 4.2 Example N0.1 Physical Realization of LPLU Section of Degree Five**  
 ( $n_p = 2, n_\lambda = 3$ ).

Another example can confirm the results, now consider these input values  $\{h_{01} = 7.4166, h_{02} = -0.8333, h_{03} = 11.9792, h_{10} = 1.0000, h_{20} = -7.5\}$  and more than one explicit solution are obtained this time as well for the coefficient matrices  $\mathbf{A}_g$  and  $\mathbf{A}_h$  and the results are fully satisfying the FES are given as follows. Confirming that the number of solution are varying for every new input values.

In this case we have obtained six number of solutions and given as follows,

- **Solution-I:**

$$\mathbf{A}_g = \begin{bmatrix} 1 & 8.2338 & 4.8949 & 12.0209 \\ 4.0000 & 25.5186 & 94.1598 & 3.1768 \\ 7.5000 & 44.5908 & 5.3628 & 0 \end{bmatrix}, \quad (4.24)$$

$$\mathbf{A}_h = \begin{bmatrix} 0 & 7.4166 & -0.8333 & 11.9792 \\ 1.0000 & -7.4367 & 92.9682 & 3.1768 \\ -7.5000 & 42.7488 & 5.3628 & 0 \end{bmatrix}$$

- **Solution-II:**

$$\mathbf{A}_g = \begin{bmatrix} 1 & 8.2338 & 4.8949 & 12.0209 \\ 4.0000 & 25.5186 & 81.1862 & 10.9962 \\ 7.5000 & 69.7702 & 55.2233 & 0 \end{bmatrix}, \quad (4.25)$$

$$\mathbf{A}_h = \begin{bmatrix} 0 & 7.4166 & -0.8333 & 11.9792 \\ 1.0000 & 4.1365 & 76.2105 & 10.9962 \\ -7.5000 & 56.6673 & 55.2233 & 0 \end{bmatrix}$$

- **Solution-III:**

$$\mathbf{A}_g = \begin{bmatrix} 1 & 8.2338 & 4.8949 & 12.0209 \\ 4.0000 & 25.5186 & 16.2462 & 36.1043 \\ 7.5000 & 0 & 30.4615 & 0 \end{bmatrix},$$

$$\mathbf{A}_h = \begin{bmatrix} 0 & 7.4166 & -0.8333 & 11.9792 \\ 1.0000 & -25.5186 & -11.3333 & -36.1043 \\ -7.5000 & 0 & -30.4615 & 0 \end{bmatrix}$$
(4.26)

- **Solution-IV:**

$$\mathbf{A}_g = \begin{bmatrix} 1 & 8.2338 & 4.8949 & 12.0209 \\ 4.0000 & 25.5186 & 102.5075 & 4.0572 \\ 7.5000 & 59.1909 & 2.5476 & 0 \end{bmatrix},$$

$$\mathbf{A}_h = \begin{bmatrix} 0 & 7.4166 & -0.8333 & 11.9792 \\ 1.0000 & -1.8423 & 101.4884 & -4.0572 \\ -7.5000 & 59.1909 & -2.5476 & 0 \end{bmatrix}$$
(4.27)

- **Solution-V:**

$$\mathbf{A}_g = \begin{bmatrix} 1 & 8.2338 & 4.8949 & 12.0209 \\ 4.0000 & 25.5186 & 16.6642 & 37.6843 \\ 7.5000 & 4.9032 & 30.9140 & 0 \end{bmatrix},$$

$$\mathbf{A}_h = \begin{bmatrix} 0 & 7.4166 & -0.8333 & 11.9792 \\ 1.0000 & -22.2498 & 3.9452 & -37.6843 \\ -7.5000 & -4.9032 & -30.9140 & 0 \end{bmatrix}$$
(4.28)

- **Solution-VI:**

$$\mathbf{A}_g = \begin{bmatrix} 1 & 8.2338 & 4.8949 & 12.0209 \\ 4.0000 & 25.5186 & 16.2463 & 36.1042 \\ 7.5000 & 0 & 30.4619 & 0 \end{bmatrix},$$

$$\mathbf{A}_h = \begin{bmatrix} 0 & 7.4166 & -0.8333 & 11.9792 \\ 1.0000 & -25.5186 & 4.0617 & -36.1042 \\ -7.5000 & 0 & -30.4619 & 0 \end{bmatrix}$$
(4.29)

The coefficient matrices  $\mathbf{A}_g$  and  $\mathbf{A}_h$  are representing explicit solutions for case-II with two lumped and three distributed ( $n_p = 2, n_\lambda = 3$ ). The physical realization corresponding to the obtained solution in expression 4.24 can also be interpreted and given in Figure 4.3 (ŞENGÜL, JANUARY 2008) (AYDOĞAR, n.d.).

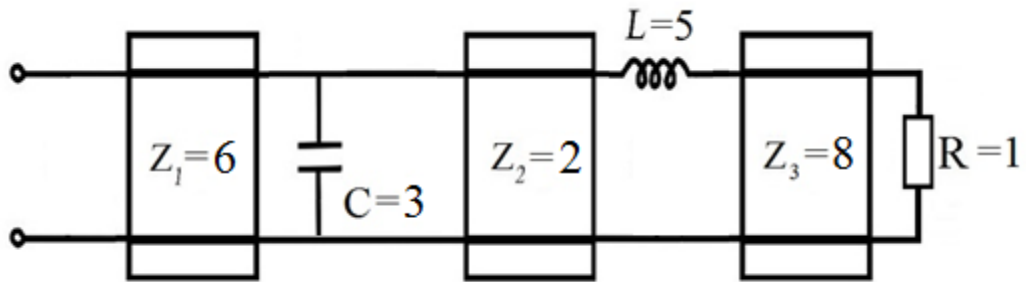

**Figure 4.3 Example No.2 Physical Realization of LPLU Section of Degree Five ( $n_p = 2, n_\lambda = 3$ ).**

## 5 CONCLUSION AND REMARKS

In this chapter the previous discussion about the construction of mixed lumped and distributed elements will be discussed and conclusive summary will be given about the “*Standard Decomposition Technique (SDT)*” use to solve fundamental equation set for general cascaded structures of two-port networks. An algorithm based on SDT to designed mixed lossless two-port cascaded network is given and the chapter is ending with remarks section.

### 5.1 Standard Decomposition Technique to Solve Fundamental Equation Set Representing a General Lossless Mixed Two-port Network Cascade

It is clear from the earlier discussions, to construct a mixed lumped and distributed two-port cascaded structure, it is critical to estimate two-variable polynomial those are satisfying the “*Fundamental Equation Set*” representation of the cascade. It is also fact that the solutions to the FES are not unique, so the problem is to determine the solutions those able to develop realizable structures. To encounter this problem in better way, a method named “*Standard Decomposition Technique (SDT)*” is proposed to solve the FES. Before moving towards the proposed algorithm following are some important point from previous study,

- There are  $n_p + 1$  independent equations having  $n_p + 1$  coefficients of  $\mathbf{A}_g$  and  $\mathbf{A}_h$  matrices each. To describe a lossless mixed two-port network  $n_p + 1$  coefficients of the matrix  $\mathbf{A}_h$ , are chosen as independent variables. The coefficient of polynomial  $f$  are also know and fixed by the designer, because of the selection of transmission zeros, in both domains  $p$  and  $\lambda$ . Hence, the choice of entire  $f(p, \lambda)$  is made in advance as  $f(p, \lambda) = f_1(p)f_2(\lambda)$ . So, by using  $n_p + 1$  equations from FES can be used to obtain  $g_{0k}$  ( $k = 0$  to  $n_p$ ) coefficients by converting  $n_p + 1$  equations into an even polynomial identity in  $p$  domain, given as follows,

$$G(-p^2) = g(p, 0)g(-p, 0) = h(p, 0)h(-p, 0) + f_1(p)f_1(-p) \quad (5.1)$$

where  $g(p, 0)$  polynomial is strictly Hurwitz and can easily be produced by doing explicit factorization of the even polynomial given in 5.1 and  $g(p, 0)$  is formed by using left half plane roots of  $G(-p^2)$ .

- Similarly,  $n_\lambda + 1$  independent equations having  $n_\lambda + 1$  coefficients of  $\mathbf{A}_g$  and  $\mathbf{A}_h$  matrices each, can be used to extract  $g_{0k}$  ( $k = 0$  to  $n_\lambda$ ) coefficients from FES by converting  $n_\lambda + 1$  equations into an even polynomial identity in complex variable  $\lambda$ , given as follows,

$$g(0, \lambda)g(0, -\lambda) = h(0, \lambda)h(0, -\lambda) + f_2(\lambda)f_2(-\lambda) \quad (5.2)$$

in this expression  $g(0, \lambda)$  is strictly Hurwitz,  $g_{0k}$  ( $k = 0$  to  $n_\lambda$ ) are determined directly by  $h_{0k}$  and  $f_2(\lambda)$ .

Thus, the polynomial sets  $\{g(p, 0), h(p, 0)$  and  $f_1(p)\}$  and  $\{g(0, \lambda), h(0, \lambda)$  and  $f_2(\lambda)\}$  form two independent lumped and distributed network prototypes respectively. These prototypes can be broken into subsections and these subsections can be connected to each other to form a desired cascade with lumped and distributed elements. As a result of above cascading procedure, connectivity matrices  $\mathbf{A}_{g_k}$  and  $\mathbf{A}_{h_k}$  are formed. Consequently, the obtained solution to FES is based on SDT and the complete algorithm is discussed in next section.

## 5.2 Standard Decomposition Algorithm to Build a General Lossless Mixed Two-port Network Cascade

A complete “*Scattering Matrix*”  $S(p, \lambda)$  representing mixed lumped and distributed lossless two-port cascade is generated by the algorithm by using first row and first column of matrix  $\mathbf{A}_h$ . Therefor the algorithm is initialized by providing the values of  $h_{0k}$  and  $h_{l0}$  as input and  $f(p, \lambda)$  is also stated by the designer in such a fashion  $f(0,0) \neq 0$ . Furthermore, the complexity of the network designed topology is also preselected by the designer, it means the total number of lumped  $n_p$  and distributed  $n_\lambda$  elements are chosen in advance. Following are the steps to implement the algorithm.



- **Inputs:**
  - $n_\lambda$  = Number of all distributed elements used in design.
  - $n_p$  = Number of all lumped elements used in design.
  - $h_{0k}$  = First row of  $\mathbf{A}_h$  matrix where  $k = 0$  to  $n_\lambda$ .
  - $h_{l0}$  = First column of  $\mathbf{A}_h$  matrix where  $l = 1$  to  $n_p$ .
  - $f_{0k}$  = Coefficients of  $f_1(p)$ .
  - $f_{k0}$  = Coefficients of  $f_2(\lambda)$ .
  
- **Step-I:**

Produce the equation  $G(-p^2) = h(p,0)h(-p,0) + f_1(p)f_1(-p)$  as a polynomial in  $-p^2$  where  $f_1(p) = f(p,0)$ .
- **Step-II:**

Find the roots of  $G(-p^2)$  polynomial generated in step I and choose the “left half plan (LHP)” zeros to develop the canonical polynomial  $g(p,\lambda)$  as a strict Hurwitz.
- **Step-III:**

Generate a polynomial  $g(0,\lambda)g(0,-\lambda) = h(0,\lambda)h(0,-\lambda) + f_2(\lambda)f_2(-\lambda)$   
 $f_2(\lambda) = f(0,\lambda)$ .
- **Step-IV:**

Now find the roots of  $g(0,\lambda)g(0,-\lambda)$  obtained in previous step. Develop the canonic form of polynomial  $g(0,\lambda)$  by using the roots of  $g(0,\lambda)g(0,-\lambda)$  lies in LHP.
- **Step-V:**

Choose the degrees of the lumped  $N_{pk}$  and distributed  $N_{\lambda k}$  subsections and select  $f_k(p)$  and  $f_k(\lambda)$  for the “Algebraic Decomposition”.
- **Step-VI:**

To obtain the scattering parameters of lumped sub-segments use the algebraic decomposition algorithm to breakdown the lumped master structures, built with the scattering parameters on the canonic polynomials  $\{g(p,0), h(p,0)$  and  $f_1(p)\}$ . Important thing to understand here is canonic polynomials  $f_k(p)$ ,  $g_k(p)$  and  $h_k(p)$  are obtained as the result of the decomposition algorithm.

- **Step-VII:**

Repeat the step VI for predefined  $f_k(\lambda)$  and  $N_{\lambda k}$  to calculate the scattering parameters of distributed sub-segments formed on canonic polynomial  $\{g(0, \lambda), h(0, \lambda)$  and  $f_2(\lambda)\}$ .

- **Step-VIII:**

For each subsection develop “Transfer Scattering Parameters”  $\mathbf{T}_k(\mathbf{p})$  and  $\mathbf{T}_k(\lambda)$  and multiply them in a sequential pattern to obtain “Transfer Scattering Matrix” for the composite structure. By doing this, get the canonic forms of polynomials  $g(p, \lambda), h(p, \lambda)$  and  $f(p, \lambda)$ , which results the connectivity matrices  $\mathbf{A}_{g_k}$  and  $\mathbf{A}_{h_k}$ .

From above discussion it is clear that in STD algorithm root finding algorithm is used twice and then followed by solution finding of several linear equations in a well sequential pattern as of described in “*Algebraic Decomposition Algorithm*” (Aksen, 1994) with a proper choice of decomposition is made by the designer. In the algorithm, the connectivity matrices  $\mathbf{A}_{g_k}$  and  $\mathbf{A}_{h_k}$  are obtained by the multiplication of each single transfer matrices developed by the algebraic decomposition matrix in one variable and the representation used for single transfer matrix in one variable for k'th lumped and distributed element is  $\mathbf{T}_{L_k}(\mathbf{p})$  and  $\mathbf{T}_{D_k}(\lambda)$  respectively and the entire overall transfer matrix can be given as,

$$\mathbf{T}(\mathbf{p}, \lambda) = \mathbf{T}_{L_1} \mathbf{T}_{D_1} \mathbf{T}_{L_2} \mathbf{T}_{D_2} \dots \dots \dots \quad (5.3)$$

The general members of the connectivity matrices  $\mathbf{A}_{g_k}$  and  $\mathbf{A}_{h_k}$  of composite design, can be given by using following sequential formulas,

$$h_{kl} = \sum_{n=0}^l h_{kn}^{(m-1)} g_{k_{l-n}} + \gamma^{(m-1)} (-1)^{k-n} g_{kn}^{(m-1)} h_{k_{l-n}} \quad (5.4)$$

$$g_{kl} = \sum_{n=0}^l g_{kn}^{(m-1)} g_{k_{l-n}} + \gamma^{(m-1)} (-1)^{k-n} h_{kn}^{(m-1)} h_{k_{l-n}} \quad (5.5)$$

where  $k = 1, 2, \dots, n_p$  and  $l = 1, 2, \dots, n_\lambda$  and the subscription  $(m - 1)$  is showing previous stage subscription  $m$  are last cascaded section.  $m$  is total number of sections in cascade and  $\gamma = \pm 1$ .

### 5.3 Remarks

- While using standard decomposition technique, when algebraic decomposition algorithm is used to find distributed and lumped subsections the transmission zeroes of  $f(p, \lambda)$  should be distributed in proper way. If LPLU is under construction, then distribution of zeroes of  $f(p, \lambda)$  is simple and straight forward. For LPLU consideration, each for SLS,  $f_k(p)$  is set to 1 and for each unit element section  $f_k(\lambda) = (1 - \lambda^2)^{1/2}$ .
- The above STD is only  $f(p, \lambda) = f_1(p)f_2(\lambda) \neq 0$  for  $p = 0$  and  $\lambda = 0$  case, that is expressing a low pass type structure i.e.  $f(0,0) \neq 0$ .
- It should also be noted that the all realizable solutions developed by using the algorithm, after solving FES are not unique, mean for same inputs that is first row and first columns of matrix  $\mathbf{A}_h$ , various solution can be obtained dependent on connectivity information.
- In order to develop a general solution, there is a need to define the realizability condition as a set of additional constraints to “*Fundamental Equation Set*”. If it is possible to generate strict scattering Hurwitz polynomial  $g(p, \lambda)$  and is also a denominator term, then the connectivity information is implanted completely in  $\mathbf{A}_{g_k}$  and  $\mathbf{A}_{h_k}$  matrices that is why known as connectivity matrices, by this way there is no need to develop synthesis procedure to obtain the final realization. However, synthesis of general designs up to limited complexity can be attempted by using trial and error method.

## 6 MATLAB CODE

In this section Matlab code for above solutions is given.

### 6.1 Case-I (Three Lumped and Two Distributed ( $n_p = 3, n_\lambda = 2$ ))

```
clear all
close all
clc
input=[];
output=[];
for i=1:1000
syms g01 g02 g10 g11 g12 g20 g21 g30
syms h01 h02 h10 h11 h12 h20 h21 h30
syms l p
syms A B C D E

g = symfun(1 + g01*l + g02*l^2 + g10*p + g11*l*p + g12*l^2*p + g20*p^2 +
g21*p^2*l +g30*p^3, [p,l]); % g00 is selected as 1
G = symfun(g(p,l) * g(-p,-l), [p,l]);

h = symfun(0 + h01*l + h02*l^2 + h10*p + h11*l*p + h12*l^2*p + h20*p^2 +
h21*p^2*l +h30*p^3, [p,l]);
%h = symfun(0 + A*l + B*l^2 + C*p + h11*l*p + h12*l^2*p + D*p^2 + h21*p^2*l
+E*p^3, [p,l]); % h00 is 0
H = symfun(h(p,l) * h(-p,-l), [p,l]);

n = 2; % The number of dist. elements
f = symfun((1-l^2)^(n/2), l);
F = symfun(f(l) * f(-l), l);

sag = (eval(H)+eval(F));
sol = (eval(G));

[cLP a] = coeffs(sol-sag, [l,p]);

equ=cLP.';

hval=randn(1,5);
input=[input;hval];
h01 =hval(1,1);
h02 =hval(1,2);
h10 =hval(1,3);
h20 =hval(1,4);
h30 =hval(1,5);
```

```

[G01, G02] = solve([eval(equ(2)),eval(equ(7))],[g01, g02]);
% g01t=eval(unique(G01(G01>0)));
% g02t=eval(unique(G02(G02>0)));
G01=double(G01);
G02=double(G02);
g01t=unique(G01(G01>0));
g02t=unique(G02(G02>0));

%Value of g30 from equa(11)
G30=solve(eval(equ(11)),g30);
G30=double(G30);
g30t=unique(G30(G30>0));
g30=g30t;

% g11t=eval(unique(G11(G11>0)));
% g11=g11t;
% pause
%Value of g10 and g20 from equa(12,13) by using first value of g30
[G10, G20] = solve([eval(equ(12)),eval(equ(13))],[g10, g20]);
G10=double(G10);
G20=double(G20);
g10t=unique(G10(G10>0));
g20t=unique(G20(G20>0));

h12t=[];g12t=[];h21t=[];g21t=[];h11t=[];g11t=[];sol_set=[];
for i=1:size(g01t,1)
    for j=1:size(g10t,1)
        g01=g01t(i,1);
        g10=g10t(j,1);
        G11=solve(eval(equ(10)),g11);
        g11t=[g11t;G11];
    end
end
g11t=double(g11t);
g11t=unique(g11t(g11t>0));

% Calculation of h12,g12,h21,g21,h11,g11
g00=1;g22=0;g31=0;g32=0;
h00=0;h22=0;h31=0;h32=0;
for i=1:size(g01t,1)
    for j=1:size(g02t,1)
        for k=1:size(g30t,1)
            for l=1:size(g10t,1)
                for m=1:size(g20t,1)
                    for n=1:size(g11t,1)
                        g01=g01t(i,1);
                        g02=g02t(j,1);
                        g30=g30t(k,1);
                        g10=g10t(l,1);
                        g20=g20t(m,1);
                        g11=g11t(n,1);
                        [H12,G12,H21,G21,H11] =
solve([eval(equ(1)),eval(equ(3)),eval(equ(4)),eval(equ(5)),eval(equ(6)),eva
l(equ(8)),eval(equ(9))],[h12,g12,h21,g21,h11]);
                        %pause
                    end
                end
            end
        end
    end
end

```

```

        H12=double (H12);
        %h12t=[h12t;H12];
        G12=double (G12);
        %g12t=[g12t;G12];
        H21=double (H21);
        %h21t=[h21t;H21];
        G21=double (G21);
        %g21t=[g21t;G21];
        H11=double (H11);
        %h11t=[h11t;H11];
        %G11=eval (G11);
        %g11t=[g11t;G11];

sol_set=[sol_set;g00,g01,g02,g10,g11,G12 (1) ,g20,G21 (1) ,g22,g30,g31,g32,h00,
h01,h02,h10,H11 (1) ,H12 (1) ,h20,H21 (1) ,h22,h30,h31,h32];

g00,g01,g02,g10,g11,G12 (2) ,g20,G21 (2) ,g22,g30,g31,g32,h00,h01,h02,h10,H11 (2)
),H12 (2) ,h20,H21 (2) ,h22,h30,h31,h32];

%sol_set=[sol_set;g01,g02,g30,g10,g20,g11,G12 (1) ,G21 (1) ,H12 (1) ,...
%
H11 (1) ,H21 (1) ;g01,g02,g30,g10,g20,g11,G12 (2) ,G21 (2) ,H12 (2) ,...
% H11 (2) ,H21 (2) ];
        end
    end
end
end
end
sol_set=real (sol_set)
sol_set=unique (sol_set, 'rows');
sol_set_ini=sol_set

remove=[];
for i=1:size (sol_set,1)
    for j=1:12
        if sol_set (i,j)<0
            remove=[remove i];
        end
    end
end
sol_set (remove, :)=[];

for i=1:size (sol_set,1)
    for j=1:size (sol_set',1) /2
        sol_set_g (i,j)=sol_set (i,j);
        sol_set_h (i,j)=sol_set (i,j+12);
    end
end

for i=1:size (sol_set,1)
Ag{i}=[sol_set_g (i,1) ,sol_set_g (i,2) ,sol_set_g (i,3) ;sol_set_g (i,4) ,sol_set_g
(i,5) ,sol_set_g (i,6) ;...

sol_set_g (i,7) ,sol_set_g (i,8) ,sol_set_g (i,9) ;sol_set_g (i,10) ,sol_set_g (i,11)
),sol_set_g (i,12) ];

```

```

Ah{i}=[sol_set_h(i,1),sol_set_h(i,2),sol_set_h(i,3);sol_set_h(i,4),sol_set_
h(i,5),sol_set_h(i,6);...

sol_set_h(i,7),sol_set_h(i,8),sol_set_h(i,9);sol_set_h(i,10),sol_set_h(i,11
),sol_set_h(i,12)];
%   fprintf('Solution NO.%d for "g" matrix is\n',i)
%   display(Ag{i});
%   fprintf('Solution NO.%d for "h" matrix is\n',i)
%   display(Ah{i});
%   fprintf('and\n\n\n')
end
check=[];
for i=1:size(sol_set,1)

g00=sol_set(i,1);g01=sol_set(i,2);g02=sol_set(i,3);g10=sol_set(i,4);g11=sol
_set(i,5);
    g12=sol_set(i,6);g20=sol_set(i,7);g21=sol_set(i,8);g22=sol_set(i,9);

g30=sol_set(i,10);g31=sol_set(i,11);g32=sol_set(i,12);h00=sol_set(i,13);

h01=sol_set(i,14);h02=sol_set(i,15);h10=sol_set(i,16);h11=sol_set(i,17);h12
=sol_set(i,18);

h20=sol_set(i,19);h21=sol_set(i,20);h22=sol_set(i,21);h30=sol_set(i,22);h31
=sol_set(i,23);h32=sol_set(i,24);
    result=eval(equ);
    result=round(result,5);

    if sum(result)==0
        j=1;
        Matrix_g{j}=[g00,g01,g02;g10,g11,g12;g20,g21,g22;g30,g31,g32];
        Matrix_h{j}=[h00,h01,h02;h10,h11,h12;h20,h21,h22;h30,h31,h32];

alloutval=[g00,g01,g02,g10,g11,g12,g20,g21,g22,g30,g31,g32,h00,h01,h02,h10,
h11,h12,h20,h21,h22,h30,h31,h32];
        fprintf('Solution NO.%d for "g" matrix is\n',j)
        display(Matrix_g{j});
        fprintf('Solution NO.%d for "h" matrix is\n',j)
        display(Matrix_h{j});
    end

    check=[check result];
end
output=[output;alloutval];
end
newoutput=[output(:,2) output(:,3) output(:,4) output(:,5) output(:,6) ...
output(:,7) output(:,8) output(:,10) output(:,17) output(:,18)
output(:,20)];
filename = 'testdata.xlsx';
xlswrite(filename,input,1);
xlswrite(filename,newoutput,2);
filename = 'datafile.xlsx';

xlswrite(filename,ssset,1);

```

## 6.2 Case-I (Three Lumped and Two Distributed ( $n_p = 2, n_\lambda = 3$ ))

```

clear all
close all
clc
%% intial part to find the equation set%%
syms g01 g02 g03 g10 g11 g12 g13 g20 g21 g22 g23
syms h01 h02 h03 h10 h11 h12 h13 h20 h21 h22 h23
syms l p
%syms A B C D E

g = symfun(1 + g01*l + g02*l^2 + g03*l^3+ g10*p + g11*l*p + g12*l^2*p +
g13*l^3*p + g20*p^2 + g21*p^2*l + g22*p^2*l^2 + g23*p^2*l^3,[p,l]); % g00
is selected as 1
G = symfun(g(p,l) * g(-p,-l), [p,l]);

h = symfun(0 + h01*l + h02*l^2 + h03*l^3+ h10*p + h11*l*p + h12*l^2*p +
h13*l^3*p + h20*p^2 + h21*p^2*l + h22*p^2*l^2 + h23*p^2*l^3,[p,l]);
%h = symfun(0 + A*l + B*l^2 + C*p + h11*l*p + h12*l^2*p + D*p^2 + h21*p^2*l
+E*p^3,[p,l]); % h00 is 0
H = symfun(h(p,l) * h(-p,-l), [p,l]);

n = 3; % The number of dist. elements
f = symfun((1-l^2)^(n/2),l);
F = symfun(f(l) * f(-l), l);

RHS = (eval(H)+eval(F));
LHS = (eval(G));

[cLP a] = coeffs(LHS-RHS,[l,p]);

equ=cLP.';
%% assigning the values to the known variables
% h01 =7.4166;
% h02 =-0.8333;
% h10 =1;
% h20 =-7.5;
% h03 =11.9792;
h01 =5.5416;
h02 =-1.6667;
h10 =-2;
h20 =22.5;
h03 =0.2917;
%% solving equ(3) for g03
G03=solve(eval(equ(3)),g03);
G03=double(G03);
g03t=unique(G03(G03>0));
g03=g03t;
%% solving equ(16) for g20
G20=solve(eval(equ(16)),g20);
G20=double(G20);
g20t=unique(G20(G20>0));
g20=g20t;
%% solving equ(17) for g10
G10=solve(eval(equ(17)),g10);

```



```

G10=double(G10);
g10t=unique(G10(G10>0));
g10=g10t;
%% solving equ(8) and equ(13) for g01 and g02
[G01, G02] = solve([eval(equ(8)),eval(equ(13))],[g01, g02]);
G01=round(double(G01),5);
G02=round(double(G02),5);
g01t=unique(G01(G01>0));
g02t=unique(G02(G02>0));
g02=g02t;

%% solving equ(15) for g11
g11t=[];
for i=1:size(g01t,1)
    g01=g01t(i);
    G11=solve(eval(equ(15)),g11);
    G11=double(G11);
    g11tt=unique(G11(G11>0));
    g11t=[g11t;g11tt];
end
%%
g01=g01t(2);g11=g11t(2);g02=g02t; g23=0;h23=0;
[G13, G22] = solve([eval(equ(2)),eval(equ(6))],[g13, g22]);
sset=[];
for i=1:size(G13,1)
    g13=G13(i); g22=G22(i);
    [G12,G21,H11,H12,H13,H21,H22] = solve([eval(equ(5)),...
    eval(equ(7)),eval(equ(9)),eval(equ(10)),...
eval(equ(11)),eval(equ(12)),eval(equ(14))],[g12,g21,h11,h12,h13,h21,h22]);
    if i==1
        Gt13=H13; Gt22=H22;
    elseif i==2
        Gt13=-H13; Gt22=H22;
    elseif i==3
        Gt13=H13; Gt22=-H22;
    else i==4
        Gt13=-H13; Gt22=-H22;
    end
    a=[G12,Gt13,G21,Gt22,H11,H12,H13,H21,H22];
    sset=[sset;a];
end
ssset=double(ssset);
remove=[];
for i=1:size(ssset,1)
    for j=1:4
        if real(ssset(i,j))<0
            remove=[remove i];
        end
    end
end
remove=unique(remove,'stable');
ssset(remove,:)=[];

remove=[];
for i=1:size(ssset,1)
    for j=1:9
        if imag(ssset(i,j))>0

```

```

        remove=[remove i];
    end
end
end
remove=unique(remove, 'stable');
ssset(remove, :)=[];

remove=[];
for i=1:size(ssset,1)
    for j=1:9
        if imag(ssset(i,j))<0
            remove=[remove i];
        end
    end
end
remove=unique(remove, 'stable');
ssset(remove, :)=[];
gt00=ones(size(ssset,1),1);
gt01=ones(size(ssset,1),1)*g01t(2);
gt02=ones(size(ssset,1),1)*g02;
gt03=ones(size(ssset,1),1)*g03;
gt10=ones(size(ssset,1),1)*g10;
gt11=ones(size(ssset,1),1)*g11t(2);
gt20=ones(size(ssset,1),1)*g20;
gt23=zeros(size(ssset,1),1);
%%
ht00=zeros(size(ssset,1),1);
ht01=ones(size(ssset,1),1)*h01;
ht02=ones(size(ssset,1),1)*h02;
ht03=ones(size(ssset,1),1)*h03;
ht10=ones(size(ssset,1),1)*h10;
ht20=ones(size(ssset,1),1)*h20;
ht23=zeros(size(ssset,1),1);

set1=[gt00 gt01 gt02 gt03 gt10 gt11 ssset(:,1) ssset(:,2) gt20 ssset(:,3)
ssset(:,4) gt23 ...
      ht00 ht01 ht02 ht03 ht10 ssset(:,5) ssset(:,6) ssset(:,7) ht20
ssset(:,8) ssset(:,9) ht23];
g01=g01t(1);g11=g11t(1);g02=g02t; g23=0;h23=0;
% [G13, G22] = solve([eval(equ(2)),eval(equ(6))],[g13, g22]);
sset=[];
ssset=[];
for i=1:size(G13,1)
    g13=G13(i); g22=G22(i);
    [G12,G21,H11,H12,H13,H21,H22] = solve([eval(equ(5)),...
eval(equ(7)),eval(equ(9)),eval(equ(10)),...
eval(equ(11)),eval(equ(12)),eval(equ(14))],[g12,g21,h11,h12,h13,h21,h22]);
    if i==1
        Gt13=H13; Gt22=H22;
    elseif i==2
        Gt13=-H13; Gt22=H22;
    elseif i==3
        Gt13=H13; Gt22=-H22;
    else i==4
        Gt13=-H13; Gt22=-H22;
    end
end
a=[G12,Gt13,G21,Gt22,H11,H12,H13,H21,H22];

```

```

        sset=[sset;a];
    end
    ssset=double(sset);
    remove=[];
    for i=1:size(ssset,1)
        for j=1:4
            if real(ssset(i,j))<0
                remove=[remove i];
            end
        end
    end
    remove=unique(remove, 'stable');
    ssset(remove,:)=[];

remove=[];
for i=1:size(ssset,1)
    for j=1:9
        if imag(ssset(i,j))>0
            remove=[remove i];
        end
    end
end
remove=unique(remove, 'stable');
ssset(remove,:)=[];

remove=[];
for i=1:size(ssset,1)
    for j=1:9
        if imag(ssset(i,j))<0
            remove=[remove i];
        end
    end
end
remove=unique(remove, 'stable');
ssset(remove,:)=[];
gt00=ones(size(ssset,1),1);
gt01=ones(size(ssset,1),1)*g01t(1);
gt02=ones(size(ssset,1),1)*g02;
gt03=ones(size(ssset,1),1)*g03;
gt10=ones(size(ssset,1),1)*g10;
gt11=ones(size(ssset,1),1)*g11t(1);
gt20=ones(size(ssset,1),1)*g20;
gt23=zeros(size(ssset,1),1);
%%
ht00=zeros(size(ssset,1),1);
ht01=ones(size(ssset,1),1)*h01;
ht02=ones(size(ssset,1),1)*h02;
ht03=ones(size(ssset,1),1)*h03;
ht10=ones(size(ssset,1),1)*h10;
ht20=ones(size(ssset,1),1)*h20;
ht23=zeros(size(ssset,1),1);

set2=[gt00 gt01 gt02 gt03 gt10 gt11 ssset(:,1) ssset(:,2) gt20 ssset(:,3)
ssset(:,4) gt23 ...
        ht00 ht01 ht02 ht03 ht10 ssset(:,5) ssset(:,6) ssset(:,7) ht20
ssset(:,8) ssset(:,9) ht23];
%%
set=[set1;set2];

```

```

sol_set=unique(set, 'rows', 'stable');
j=0;
result1=[];result2=[];all_results=[];
check=[];output=[];
for i=1:size(sol_set,1)

g00=sol_set(i,1);g01=sol_set(i,2);g02=sol_set(i,3);g03=sol_set(i,4);g10=sol
_set(i,5);g11=sol_set(i,6);

g12=sol_set(i,7);g13=sol_set(i,8);g20=sol_set(i,9);g21=sol_set(i,10);g22=so
l_set(i,11);g23=sol_set(i,12);

h00=sol_set(i,13);h01=sol_set(i,14);h02=sol_set(i,15);h03=sol_set(i,16);h10
=sol_set(i,17);h11=sol_set(i,18);

h12=sol_set(i,19);h13=sol_set(i,20);h20=sol_set(i,21);h21=sol_set(i,22);h22
=sol_set(i,23);h23=sol_set(i,24);
    result=eval(equ); % equation eveluation
    result1=[result1,result];%store of evaluated result
    result=round(result,3);%rounded result
    result2=[result2,result];%store of evaluated and rounded result

result3=[g00,g01,g02,g03,g10,g11,g12,g13,g20,g21,g22,g23,h00,h01,h02,h03,h1
0,h11,h12,h13,h20,h21,h22,h23];%founded values of variables
    all_results=[all_results;result3];% store of all founded values of
variables
    if sum(result)==0
        j=j+1;
        Matrix_g{j}=[g00,g01,g02,g03;g10,g11,g12,g13;g20,g21,g22,g23];
        Matrix_h{j}=[h00,h01,h02,h03;h10,h11,h12,h13;h20,h21,h22,h23];

outputt=[g00,g01,g02,g03,g10,g11,g12,g13,g20,g21,g22,g23,h00,h01,h02,h03,h1
0,h11,h12,h13,h20,h21,h22,h23];
        fprintf('Solution NO.%d for "g" matrix is\n',j)
        display(Matrix_g{j});
        fprintf('Solution NO.%d for "h" matrix is\n',j)
        display(Matrix_h{j});
        output=[output;outputt];%varifed and satisfying equations
    end
end
end

```

## References

- Aksen, A., 1994. Design of Lossless Two-ports with Mixed Lumped and Distributed. *Ph.D. Thesis, Ruhr University.*
- AYDOĞAR, Z., n.d. SCATTERING TRANSFER MATRIX FACTORIZATION BASED SYNTHESIS OF RESISTIVELY TERMINATED LC LADDER NETWORKS. In: *Master's Thesis.* s.l.:s.n.
- Balabanian, N. & Bickart, T. A., 1969. *T. A., Electrical Network Theory.* s.l.:John Wiley&Sons Inc..
- Baum, R. F., 1948. A Contribution to the Approximation Problem. *Proc IRE*, Volume 36(7), pp. 863-869.
- Beccari, C., 1984. Broadband Matching Using the Real Frequency Technique. *IEEE Transection on Crcuit and Systems*, Volume CAS 37, pp. 212-222.
- Belevitch, V., 1968. *Classical Network Theory.* s.l.:Holden Day, San Francisco, CA..
- Bode, H., 1945. Network Analysis and Feedback Amplifier Design. *Van Nostrand, NY.*
- Bose, N. K., 1982. Applied Multi Dimensional System Teory. *Van Nostrand Reinhold.*
- Carlin, H. & Amstutz, P., 1981. On optimum broad-band matching. *IEEE Transactions on Circuits and Systems*, 28(5), pp. 401 - 405.
- Carlin, H. J., 1971. Distributed Circuit Design with Transmission Line Elements. *IEEE Proceedings*, Issue 3, pp. 1059-1081.
- Carlin, H. J., 1977. A New Approach to Gain-Bandwidth Problems. *IEEE Transaction on Circuit and System*, CAS-24(4), pp. 170-175.
- Carlin, H. J. & Civalleri, P., 1985. On Flat Gain with Frequency-Dependent Terminations. *IEEE Transactions on Circuits and Systems*, Volume CAS 32, pp. 827-839.
- Carlin, H. J. & Yarman, B. S., 1983. The Double Matching Problem: Analytic and Real Frequency Solutions. *IEEE Transactions on Circuits and Systems*, CAS-30(1), pp. 15-28.
- Chen, W.-K., 1988. Broadband Matching: Theory and Implementations. *World Scientific*, Volume 1.
- Darlington, S., 1939. Synthesis of Reactance 4 Poles. *MIT J. Mathematics and Physics*, Volume 18, pp. 257-353 .

- Fano, R. M., 1950. Theoretical limitations on the broadband matching of arbitrary impedances. *Journal of the Franklin Institute*, 249(1), pp. 57-83.
- Fettweis, A., 1982. On the Scattering Matrix and the Scattering Transfer Matrix of Multidimensional Lossless Two-Ports. *Archiv Elektr. Übertragung*, Volume 36, pp. 374-381.
- Fettweis, A. & Pandel, J., 1987. Numerical Solution to Broadband Matching Based on Parametric Representation. *Arch. Elektr. Übertragung*, Volume 41, pp. 202-209.
- Hatley, W. T., 1967. Computer Analysis of Wideband Impedance Matching. *Stanford University, Stanford Electronics Laboratories, CA*, Volume Tech. Report No:6657-2.
- Kody & Stoer, 1972. Rational Chebyshev Approximation Using Interpolation. *Springer Verlag*, , Volume Numerische Mat.Bd.9.
- Koga, T., 1971. Synthesis of a Resistively Terminated Cascade of Uniform Lossless Transmission Lines and Lumped Passive Lossless Two-Ports. *IEEE transaction on Circuit Theory*, Volume 18, pp. 444-455.
- Koga, T., 1971. Synthesis of a Resistively Terminated Cascade of Uniform Lossless Transmission Lines and Lumped Passive Tow-Ports. *IEEE Transactions on Circuit Theory*, Volume 18, pp. 444-455.
- Kotiveeriah, P., 1972. Rational Approximation of Frequency Data by Physically Realizable Network Functions. *Ph.D. Thesis, Cornell University*,.
- Medely, M. W., 1993. *Microwave and RF Circuits: Analysis, Synthesis and Design*. s.l.:Artech House Inc..
- Richards, P. I., 1948. Resistor-Transmission-Line Circuits. *Proceedings of the IRE*, Volume 36, pp. 217-220.
- Seaks, R., 1976. The Factorization Problem a Survey. *Proceedings of the IEEE*, April, Volume 64, pp. 90-95.
- ŞENGÜL, M., 2006. Circuit Models with Mixed Lumped and Distributed Elements for Passive One-Port Devices. *Ph.D. Thesis, IŞIK UNIVERSITY*.
- ŞENGÜL, M., JANUARY 2008. Synthesis of Cascaded Lossless Commensurate Lines. *IEEE TRANSACTIONS ON CIRCUITS AND SYSTEMS—II: EXPRESS BRIEFS*, 55(1).
- Smilen, L. I., 1964. Interpolation on Real Frequency Axis. *Microwave Research Inst., Polytechnic Institute of Brooklyn*, Volume Report No: PIBMRI 121164.
- Yarman, B. S., 1982. A Simplified Real Frequency Technique for Broadband Matching a Complex Generator to a Complex Load. *RCA Review*, Volume 43, pp. 529-541.

- Yarman, B. S., 1982. Broadband Matching a Complex Generator to a Complex. *Ph.D. Thesis, Cornell University*.
- Yarman, B. S., 1982. Real Frequency Broadband Matching Using Linear Programming. *RCA Review*, Volume 43, pp. 626-654.
- Yarman, B. S., 1985. Modern Approaches to Broadband Matching Problems. *Proc. IEE*, Volume 132, pp. 87-92.
- Yarman, B. S., 1991. Novel Circuit Configurations to Design Loss Balanced 0o-360o Digital Phase Shifters. *Archiv Für Elektronik und Übertragungstechnik*, Volume 45(2).
- Yarman, B. S. & Aksen, A., 1992. An Integrated Design Tool to Construct Lossless Matching Networks with Mixed Lumped and Distributed Elements. *IEEE Transactions on Circuits and Systems*, Volume CAS 39(9), pp. 713-723.
- Yarman, B. S. & Fettweis, A., 1990. Computer Aided Double Matching via Parametric Representation of Brune Functions. *IEEE Transactions on Circuits and Systems*, Volume CAS 37, pp. 212-222.
- Youla, D., 1964. A New Theory of Broad-band Matching. *IEEE Transactions on Circuit Theory*, 11(1), pp. 30 - 50.
- Youla, D. C. & Saito, M., 1966. Interpolation with Positive Real Functions. *Microwave Research Inst., Polytechnic Institute of Brooklyn*, Volume Report No: PIBMRI-1353-66.
- Youla, D. C., Yarman, B. S. & Carlin, H. J., 1984. Double Broadband Matching and Problem of Reciprocal Reactance 2n-port Cascade Decomposition. *Int. J. Circuit Theory and App.*, Volume 12, pp. 269-281.

## CURRICULUM VITAE

### **NAUMAN TABASSUM**

[naumantabassum@ymail.com](mailto:naumantabassum@ymail.com)



Nauman Tabassum, born in Rawalpindi Pakistan Graduated in the field of Electronics from Quaid-i-Azam University, Islamabad, Pakistan and completed Master's degree with thesis in the field of electronics engineering, from Kadir Has University Istanbul, Turkey.

### **Qualifications:**

<b>Masters (Thesis)</b>	<b>Kadir Has University, Istanbul Turkey, Department: <u>Electronics Engineering</u></b>
<b>Bechlors</b>	<b>Quaid-i-Azam University Islamabad. Department: <u>Electronics</u></b>
<b>HSSC</b>	<b>Army Public College(QAAB) Damhail Camp Rawalpindi. Affiliated with <b>FBISE Islamabad.</b></b>
<b>SSC</b>	<b>F.G Boys High School, R.A Bazar Rawalpindi.</b>

### **Publications:**

- Working on three publications hopeful to be published in this year.