

# Reconfigurable and Transformational Product Design Concepts and Applications: A Case Study of Innovative Furniture

A thesis submitted to the  
Graduate School of Natural and Applied Sciences

by

Aizimaiti AIKEBAIER

in partial fulfillment for the  
degree of Master of Science

in

Industrial and Systems Engineering



This is to certify that we have read this thesis and that in our opinion it is fully adequate, in scope and quality, as a thesis for the degree of Master of Science in Industrial and Systems Engineering.

**APPROVED BY:**

Assoc. Prof. Kaşif Teker  
(Thesis Advisor)

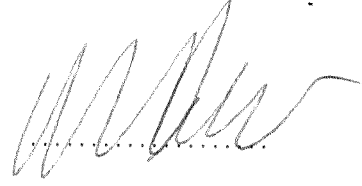

Prof. Muammer Koç  
(Thesis Co-advisor)

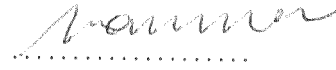

Prof. Dr. Orhan Şahin

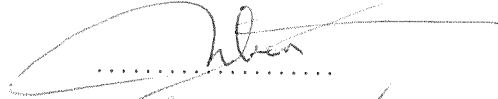

Asst. Prof. Murat Küçükvar

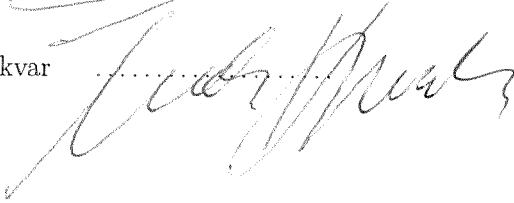

This is to confirm that this thesis complies with all the standards set by the Graduate School of Natural and Applied Sciences of İstanbul Şehir University:

**DATE OF APPROVAL:**

27 August 2015

**SEAL/SIGNATURE:**





## Declaration of Authorship

I, Aizimaiti AIKEBAIER, declare that this thesis titled, "Reconfigurable and Transformational Product Design Concepts and Applications: A Case Study of Innovative Furniture" and the work presented in it are my own. I confirm that:

- This work was done wholly or mainly while in candidature for a research degree at this University.
- Where any part of this thesis has previously been submitted for a degree or any other qualification at this University or any other institution, this has been clearly stated.
- Where I have consulted the published work of others, this is always clearly attributed.
- Where I have quoted from the work of others, the source is always given. With the exception of such quotations, this thesis is entirely my own work.
- I have acknowledged all main sources of help.
- Where the thesis is based on work done by myself jointly with others, I have made clear exactly what was done by others and what I have contributed myself.

Signed: \_\_\_\_\_



Date: \_\_\_\_\_

27.08.2015

# Reconfigurable and Transformational Product Design Concepts and Applications: A Case Study of Innovative Furniture

Aizimaiti AIKEBAIER

## Abstract

Multifarious design methods have been developed in engineering and art disciplines in the search of better quality, efficiency, cost-effectiveness, functionality, and novelty. Transformational and reconfigurable devices in different fields have become trendier after the 20th century. Customers expect both enhanced performances and reduced complexity level on their products. Compared to static state products with single function amongst furniture product category, the product items with transformational functionality and reconfigurability possess higher ability for coping different customer needs and expectations. For this case, research and development on innovative, novel product with specific design methodology is essential. In this paper, by reviewing and synthesizing previous research on transformational design and reconfigurable product systems, we carried out the integration of different structures and products, which are from various single state products. These processes are all under the transformational, flexible, reconfigurable design guidelines to obtain the overall function structure of the ideal integrated product.

**Keywords:** Product development, Transformational Design, Reconfigurability

# Yeniden yapılandırılabilir ve Transformal Ürün Tasarım Kavramları ve Uygulamaları: Yenilikçi Mobilya Ürünü Çalışması

Aizimaiti AIKEBAIER

## ÖZ

Çok yönlü tasarım yöntemleri daha iyi kalite, verimlilik, maliyet etkinliği, işlevsellik ve yenilik arayışı içinde mühendislik ve sanat dallarında geliştirilmiştir. Farklı alanlarda dönüşümcü ve yeniden konfigüre cihazlar yirminci yüz yıldan sonra trendier haline gelmiştir. Müşteriler gelişmiş performans ve onların ürünleri üzerinde azaltılmış karmaşıklık düzeyini de beklemeye başladı. Mobilya ürün kategorisinde tek fonksiyonu ve sabit halet ürünlere kıyasladığında, dönüşümsel işlevsellik ve esneklik ile ürün öğeleri farklı müşteri ihtiyaçlarını ve beklentilerini başa çıkma yeteneğine sahiptir. Bu yüzden özel tasarım metodolojisi yenilikçi ürün üzerinde araştırma ve geliştirme için esastır. Bu çalışmada, dönüşümsel tasarım ve yeniden konfigüre ürün sistemlerindeki önceki araştırmalar sentezlenerek, çeşitli tek halet ürünlerden farklı yapılarla ve ürünlerin entegrasyonu yürütmüştür. Bu süreçler İdeal entegre ürün genel işlevi yapısını elde etmek için tüm dönüşüm, esnek, yeniden konfigüre tasarım kuralları altındadır.

**Anahtar Sözcükler:** Ürün Gelişmesi, Dönüşülebilir Tasarım, Esnek Tasarım

*This thesis is dedicated to my mother Aynisa and my brother Jesur.  
Their love, encouragement, and endless support throughout my life  
have made me stronger.*

# Acknowledgments

I would like to express my most valuable appreciation to my advisor Assoc. Prof. Kaşif Teker for his support, contribution, patience, and guidance. Without his patience and sacrificing hours for me, this thesis will never be written. I also would like to thank to him for the experience I had as an assistant under his directorship.

I want to thank my co-advisor Prof. Muammer Koç for his valuable guidance and contribution for my thesis. I am able to do research in this area thanks to his advices.

Special thanks to Prof. Dr. Orhan Şahin ,and Asst. Prof. Murat Küçükvar, for being committee members of my thesis.

Finally, I wish to thank my parents, and my brother for their support and encouragement throughout my study.

# Contents

<b>Declaration of Authorship</b>	<b>ii</b>
<b>Abstract</b>	<b>iii</b>
<b>Öz</b>	<b>iv</b>
<b>Acknowledgments</b>	<b>vi</b>
<b>List of Tables</b>	<b>ix</b>
<b>1 Introduction</b>	<b>1</b>
1.1 Motivation . . . . .	1
1.2 Product innovation and design . . . . .	2
1.3 Research Objective . . . . .	6
1.4 Thesis Outline . . . . .	6
<b>2 Background and Literature Review</b>	<b>7</b>
2.1 Design and production . . . . .	7
2.2 Engineering design . . . . .	8
2.3 Product design . . . . .	8
2.3.1 Universal Design . . . . .	11
2.3.2 Design for Flexibility . . . . .	13
2.3.2.1 Methodology: assessing product flexibility . . . . .	13
2.3.3 Transformational Design . . . . .	16
2.3.3.1 Principles . . . . .	17
2.3.3.2 Facilitators . . . . .	19
2.3.4 Design by analogy . . . . .	29
2.3.4.1 Definition of Analogy Design . . . . .	30
2.3.4.2 Analogies Using Nature . . . . .	30
2.3.4.3 Biological Analogies for Design . . . . .	32
2.3.4.4 Types of similarity relationships . . . . .	34
2.4 Reconfigurability and Reconfigurable Design . . . . .	35
2.4.1 Reconfigurable manufacturing system (RMS) . . . . .	35
2.4.2 Reconfigurable modular robot machines (RMs) . . . . .	37
2.4.3 Reconfigurable product/system design . . . . .	40
<b>3 Identification of a case/product need: Case Study</b>	<b>43</b>
3.1 Problem/Case Statement . . . . .	43

---

3.2	The need for integrated product . . . . .	47
3.3	Summary . . . . .	47
<b>4</b>	<b>Integrated Product Design-Implementation of Design Methods</b>	<b>49</b>
4.1	Identification of a design problem . . . . .	49
4.1.1	Target product identification . . . . .	49
4.1.2	Customer Survey . . . . .	52
4.1.3	Quality Function Development (QFD) Analysis . . . . .	56
4.2	Analysis and examples of target product . . . . .	60
4.2.1	Market Analysis . . . . .	61
4.2.2	New Product Information in current market . . . . .	65
4.3	Summary . . . . .	69
<b>5</b>	<b>Conceptual Design for Integrated Product</b>	<b>70</b>
5.1	Initial Concept Design Ideas for Each Unit . . . . .	70
5.1.1	Drawer Units . . . . .	70
5.1.2	Valet Stand . . . . .	75
5.1.3	Coat Rack . . . . .	77
5.1.4	Lamp . . . . .	83
5.2	Generating Product Alternatives (Integration of New Ideas and Prototyping)	83
5.3	Analysis for Integrations (Materials, Cost, Dimension, Weight) . . . . .	86
5.4	Chapter Summary . . . . .	90
<b>6</b>	<b>Results, Conclusion, and Summary</b>	<b>92</b>
6.1	Prototyping, Testing, and Validation . . . . .	92
6.1.1	Prototype Models . . . . .	92
6.1.2	Testing and Validation . . . . .	95
6.2	Summary and Recommended Future Work . . . . .	97
<b>A</b>	<b>Survey Questionnaire</b>	<b>99</b>
	<b>Bibliography</b>	<b>101</b>

# List of Tables

2.1	Generic CMEA basic columns . . . . .	14
2.2	Generic change modes and effects analysis design flexibility table . . . . .	15
2.3	Generic CMEA Occurrence . . . . .	16
2.4	Generic CMEA Readiness . . . . .	16
2.5	Biological Organizational Levels . . . . .	33
4.1	Ranking of problems and needs for each furniture item . . . . .	54
4.2	Ranking of problems and needs for each furniture item . . . . .	55
4.3	Ranking of problems and needs for each furniture item . . . . .	55
4.4	Ranking of problems and needs for each furniture item . . . . .	56
4.5	Research results on several types of coat rack with their prices . . . . .	62
4.6	Research results on several types of valet stand with their general prices . . . . .	64
4.7	Research results on several types of lamps with their general prices . . . . .	65
5.1	Drawer unit initial design ideas . . . . .	74
5.2	Valet stand design ideas . . . . .	77
5.3	Coat rack design ideas . . . . .	82
5.4	Material selection analysis for the first integration mode . . . . .	89
5.5	Material selection analysis for the third integration mode . . . . .	89
6.1	Overall information of the first prototype model . . . . .	94
6.2	Overall information of the second prototype model . . . . .	95



# Chapter 1

## Introduction

### 1.1 Motivation

In the past, there were many manufacturing companies or product development organizations having the capability to supply their products with very limited amount of and/or incremental innovation. They mainly focused on the level of quality and merely developing innovative products to a certain level that could hold their competitiveness in the market. In today's market, this approach still exists, i.e. implementing products with long life-cycles and have few chances for innovative development [1]. However, due to the factors such as globalization and the development of foreign trade, the demand has increased to improve the efficiency and effectiveness of manufacturing companies. Product manufactures need more than good quality products to maintain their place on the world stage. Product manufactures need to develop innovative processes, products and management methods that can lead cost reduction, improve productivity, increase profitability, diversify product presentations, increase functionality and reuse, and overall increase the life-cycle efficiency and value of their products [1].

Consumer needs and expectations are a core factor in driving the innovative products in the global markets. Customers look forward to use products that continually improve and make their lives easier. Essentially, modern customers in today's market also are not willing to accept mediocrity, because they want something different than the others (i.e. uniqueness). Therefore, innovation is important, as it is one of the primary ways to differentiate your product from the competition [1].

From the point of economic value, innovation plays an important role and seen as a main impetus in economic growth. Since the 20th century, manufacturing companies all around the world have been starting take innovation into consideration for sustainability

of their development as a significant factor. For instance, in some developed countries, numerous of big firms invest a huge amount of resources on the research of innovation development. According to statistics [2], "in the United States today, there are more than 16,000 firms that currently operate their own industrial research labs, and there are at least 20 firms that have annual R&D budgets in excess of USD 1 billion. In fact, when American manufacturing firms are ranked by the size of their R&D budgets, the top 20 firms spent a total of USD 54 billion on R&D in the year 2000". Additionally, among the world's most innovative companies ranked in 2014, the Salesforce.com Company, which is holding the first stage, located in United States, have 35.6% growth in 12-month sales growth and 24.1% 5-year annualized total return. Among these records, the innovation premium is 75.9% [3].

## 1.2 Product innovation and design

"Design is the creation of a plan or convention for the construction of an object or a system (as in architectural blueprints, engineering drawings, business processes, circuit diagrams and sewing patterns)" [4]. Design is often defined as synonymous with what engineers "do". Early accounts from professional engineering organizations viewed design as a critical factor in their cognition of engineering: "the creative application of scientific principles to design or develop structures, machines, apparatus, or manufacturing processes, or works utilizing them singly or in combination..." [5].

Design is known to have different implications in different domains (see design disciplines, below). In some cases the direct interpretation of an object (as in pottery, engineering, management and graphic design) is also called design. There are many disciplines of design, including mechanical engineering design, electrical engineering design, architectural design, industrial design, food science design, furniture design, material design, aerospace design, and bridge/roadway design as well as process design (Figure 1.1). For different design categories, the problems appear in different disciplines of corresponding design techniques. Designing has some indispensable factors that need to be considered, such as: aesthetic, functional, economic, and sociopolitical dimensions of both the design object and the process of design. Design may contain considerable research, thought, modeling, interactive adjustment, and re-design. Meanwhile, different types of object would be designed, such as clothing, graphical user interfaces, construction, corporate advertising, business strategy, and processes [6].

The ability to invent and innovate is at the core position of an engineering design process and product development that establishes the basis for economical growth through technological superiority. Since global economic competition and interactively

related technological developments prompt social changes such as increasingly demanding and diverse consumers, new products are introduced to the market increasingly more often than ever before. However, despite newly designed products are blending into the society frequently, they still cannot fulfill the constantly varying customer needs by time, location, culture, age, etc. Furthermore, frequent introduction, limited use and increasing disposal of more and more products are considered to be a serious threat to the environment and society in the long-term.

The demands on today's products have become increasingly complex and comprehensive as customers expectation with enhanced performance through a variety of new products. In traditional design, the designer is faced with a challenge of changing a single product to improve efficiency, time, cost, material resources, etc. Recently, designers have been more and more dealing with design challenges of multi-functionality, reuse, life cycle costs, and end of useful life issues. Plenty of design methodologies have been explored, as the engineering community starts to seek the higher efficiency, quality, and novelty of innovation and to address the new challenges in the design space, consumer behavior, and demand, as well as reap the benefits of new technologies in materials, information technology, and manufacturing.

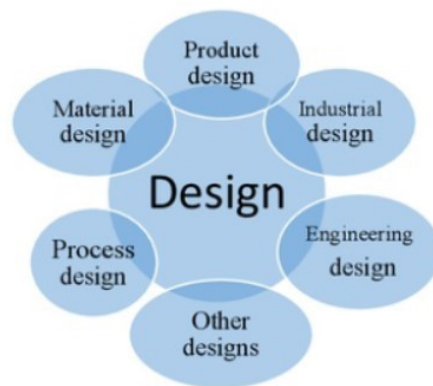

FIGURE 1.1: Schema of Design Category

Current research in product innovation and development methods firmly embraces the conception of focusing on the customer needs including variation by time and location, from business strategy development to needs/market analysis to rapid prototype testing and validation. According to Riley [7], "to satisfy customer requirements and needs that are changing over time as (a) technology advances, (b) societal and cultural trends evolve, (c) manufacturing capabilities improve to new ways of fabrication, and (d) logistic capacities expand to new markets, designers focus on to new markets. Main focus points are: (1) resolving the stated customer and market requirements and (2) enlarging end

user benefits that would be provided by the new product reconfigurations using various design methods".

According to Riley [7], "Product development is a process that includes tasks or phases for (1) understanding the real user/consumer demand, (2) communicating (to understand the needs, to gather suggestions, to persuade the customer and stakeholders, etc.), (3) creative design and thinking, (4) testing, and (5) refining, culminating, etc. towards full scale product production". It may regard modification of an existing product or its presentation, or formulation of an entirely new product that can satisfy an existent customer need or market demand. Once customer needs are fully understood, the development of competitive products in the market must be analyzed in terms of level of fulfilling the current needs of customers or customer segments. Understanding the synopsis of design architecture, customer needs, and the competition on the market leads designers and/or design team toward the generation of a new design concept. During the development process, after analyzing all available information, designers would consider about design methods to be followed in the process, the functions of new product, how it can fit into the market, and cost range of the product.

After selecting and reaching a suitable concept for the needs, the design process will continue towards implementation, which is the most important phase of product development. The well designed product can be achieved through a good implementation of the methods and activities in design and development process.

Different alternative design methods have been explored, as the engineering community continuously seeks to increase the efficiency, quality, and novelty of innovation. Meanwhile, designers try find ways to develop effective and fast design process in an increasingly competitive global market. Some design tools are well equipped as multi functional to deal with different problems; others are best suited for some specific fields or applications [8]. Benjamin Ha [9] stated "Launching new products effectively has become a core competition ability of many businesses, ranging from information technology to original equipment manufacturers to fashion designers".

Designers are beginning to select the design target from a single product towards a domain of a product family, which are expected to evolve, perform multiple tasks, and would be operating under the varying circumstances. One way to fulfill this demand is mass customization, which is rather a manufacturing capability to be able to introduce large amount of various types of products to the market with relatively lower cost to enable customer to purchase different products that each can be used for a unique purpose [10]. Another approach is effective use of the configuration convertibility of each single product to perform with higher level of functionality. Geometry or shape

change exists everywhere in our daily lives. Those kind of changes in one object's location can be represented by different terms, for instance "translate", "rotate", "shift", etc. Also, the changes in its form may be described by using terms like "deform", "bend", "elongate", etc. [11]. Thus, reconfigurable product design methods emerged due to growing demands for multi-functional yet cost-effective products that can satisfy diverse and varying consumer needs by time, location, age, etc. With reconfigurable design, the products are able to change their configuration to match the varying environments or customer needs. According to Haldaman and Parkinson [12] "Reconfigurability is an established strategy for meeting diverse needs with a single product".

By creating a reconfigurable, transformable, flexible product that performs different tasks and functions in one product but in various forms, the consequences would be increasing the efficiency of usage as stated below [13]:

- Total cost can be reduced by decreasing the amount of labor and material compared to using a single device for each different task or configuration
- Some special products, like weight-sensitive devices, can greatly benefit from reconfiguration
- Decrease in complexity of scheduling and logistical issues for single function products by using multi-functional product system
- Some transforming products can complete their functions between states that are hardly performed in single-state products
- Disposition time would be reduced for many products, which will increase functional life cycle of products and thus further benefiting the economy, environment and society
- The functions that a single product can carry out will not need to be associated or require the same structural feature, as with other single-state multi-functional devices.

The approach explored in this study is based on three main elements. First, understand the potential and impact of reconfigurable products where reconfiguration can be implemented and proven beneficial, and second; develop the reconfigurable products concepts for a selected domain of application with multiple physical configurations (or states) that enable enhancement or multiplicity of functions; and third, demonstrate, validate and test these concepts through prototypes.

### 1.3 Research Objective

The objective of this research is to develop functional morphing methodologies and algorithms. Additionally, exploring and implementing the stages of a new product development including design process, evaluation, and performance, specifically for the topics of potential re-configurability and formability evaluation for single state products to develop multi-stage functional products. In this study, the focus will be on implementing the reconfigurable and transformational design concept, and resolve the problems associated with potentially varying customer needs and requirements. Specific research objectives are as follows:

1. Analyze, compare, and understand different product design methodologies, including reconfigurable design, transformational design, and flexible design methods
2. Develop or improve design methodologies for morphing based reconfigurable or transforming design of evolutionary products through further analysis and comparison
3. Apply reconfigurable and transformational design concept to develop multi-functional consumer product (e.g. furniture items which are normally used in offices, student houses, or dormitories)

Fulfillment of the above objectives will make it feasible to interpret shape and functional changes on a single product based on the physical attributes and process conditions, and thereby increase the efficiency, reusability, and life cycle benefit/cost.

### 1.4 Thesis Outline

The remainder of this thesis is organized as follows: Chapter 2 focuses on reviewing current academic literature regarding different types of product design methods developed and used for constructing product portfolio concepts, such as, flexible product design, transformational design, design-by-analogy, biomimetic design, etc. Chapter 3 is an introduction of the identification for a case or product need, which depends on preliminary observation in university dorms and discussions of integrated product needs. In Chapter 4, demonstration of the integrated product design process, implementation of the selected products, and the discussions of design constraints are presented. In Chapter 5, different conceptual design ideas and generation of integrated product alternatives using different design methods are discussed. Chapter 6 summarizes the project results and highlights the major contributions of this dissertation. This dissertation is completed by concluding remarks and future research suggestions.

## Chapter 2

# Background and Literature Review

In this chapter, a comprehensive review of related literature on various product design methods, especially transformational, reconfigurable, and flexible product design methods is presented. These design methods are compared in terms of their similarities and major overlaps among each other in addition to presentation of examples for each methodology.

### 2.1 Design and production

The relationship between design and production is in planning and implementation. In the abstract, the plan should anticipate and offset for potential problems in the implementation process. Therefore, in some ways, design includes both problem solving and creativity. In contrast, production involves a routine or pre-planned process. Even sometime, a design may also be a single plan that is not resulting in a production or engineering processes although a working knowledge of such processes is usually expected [14].

Design and production are convolved in many creative professional careers, meaning problem solving is part of carrying out and the reverse. The increase of rearranging costs will lead the requirement of separating design from production [14].

This does not mean production will never include problem solving or creativity, nor that design always involves creativity. The imperfection of a design would apportion a production position (e.g. production artist, construction worker) by using creativity or problem-solving skills to offset the neglected part in the design process. Similarly, a design may be a simple repetition (copy) of a known preexisting solution, requiring minimal, if any, creativity or problem solving skills from the designer [14].

## 2.2 Engineering design

Engineering design is the process of creating a system, constituent, or process to satisfy expected needs. It is also a decision-making process, in which basic sciences, mathematical theories and engineering sciences, are applied for optimization of current resources to achieve a stated objective [15]. The fundamental elements of engineering design process are the establishment of objectives and standards, synthesis, analysis, construction, testing, and evaluation.

As aforementioned, the engineering design process is a multi-step process, which includes research, conceptualization, feasibility assessment, establishing design requirements, preliminary design, detailed design, production planning and tool design, and finally production [15]. There are certain features that must be included in the engineering design process including development of designers creativity, use of open-type problems, using of modern design theory and methodology or advanced tools, conceptualizing and specifying design problem statements that may occur, taking into account of alternative solutions and feasibility, production processes, simultaneous engineering design, and detailed system description. Moreover, there are several practical necessary restrictions to be included in engineering design process, such as economic factors, safety, reliability, aesthetics, and social impact [16]. In brief, the engineering design process is the formulation of a plan to help an engineer to make a product with specified performance goals.

## 2.3 Product design

According to Riley [7] "Product design is the process of creating a new product to meet stated customer needs and cycling the process by the development of business and implementing it into commerce". Design includes activities such as scheming the model, look and esthetic of the product, designating the product's mechanical architecture, selecting materials of object product, and implementing the different essential elements to make the product work. The following development is referred as generalizing the whole process of identifying a market opportunity, attract the identified market by generating new product concept, and finally, testing, modifying and refining the product until it is ready for production.

"The task of developing outstanding new products is difficult, time-consuming, and costly. People who have never been involved in a development effort are astounded by the amount of time and money that goes into a new product. Great products are



not simply designed, but instead they evolve over time through countless hours of research, analysis, design studies, engineering and prototyping efforts, and finally, testing, modifying, and re-testing until the design has been perfected" [7].

New product development process varies among companies, even for products that are produced by the same company. In spite of these differences, a good new product is the fruit of both relevant methodical development effort with good conceptualized new product design planning and project aim [7]. Based on the work of Khedkar, Mundada, and Jadhav, a development of new product project, which possess a good market potential is generally organized along the steps as following:

1. Identify Customer Needs: Designers/researchers identify customer needs by interviewing potential purchasers or focus groups, and/or by observing products in use which have similarities with the target product. Customer needs can be classified as hidden needs and explicit needs. At hidden needs, customers may not be aware of problems unlike explicit needs, which are reported by potential buyer. For all these needs, designers/researchers develop the necessary information regarding with the performance, size, weight, service life, and other norms of the product. Customer needs and product specifications are organized into a hierarchical list with a comparative rating value given to each need and specification" [17].

2. Establish Target Specifications: According to collected customers' needs and study of similar and competitive products that had been observed during the first step, the designers/design teams set up the objective specifications of the prospective new product. The process of identifying customer needs is the core of marketing.

Target specifications are essentially a notion that would be constrained by the number of technical and market factors. Thus, after designers/design teams have proposed initial product concepts, the target specifications will be taken into consideration in terms of technical, manufacturing, and economic realities for final improvement.

3. Analyze Competitive Products (Benchmarking): As we mentioned in the second step, an analysis and study of similar and competitive products should be conducted during the process of establishing target specifications. Some products with good design attributes and properties should be simulated or evaluated upon in new product" [17].

Improvements can be directly executed on a new product by understanding the shortcomings of similar and competitive products, so that the new product would be preponderated the pre-superiorities of others. The advance of design is made by reviewing the successes and failures of prior works. In other words, the study and making analysis of competitive products can guide designers toward the effective way and provide them a proper starting point for future design.

4. Generate Product Concepts (Creativity): Designers will come up with a list of product concepts based on the specified target, and select be the best one satisfying the target specifications. Engineers will use the primary concept to develop basic construction of the product, then the designers will be depicting product styles and alternative layouts [17].

5. Select a Product Concept (Decision making): After the evaluation and trade-offs of the process, the best candidate will be selected form the generated concepts. The selection process can proceed by polling according to the factors like matching level, customer preferences etc. The additional market survey is held regarding determined candidates for obtaining feedback and comment from certain key customers or focus groups" [7].

6. Refine Product Specifications (Improvement): In this step, the specifications of target product are refined through implemented activities. Final specifications are the result of tradeoffs made between technical feasibility, expected service life, projected selling price, and the financial limitations of the development project. However, when product attributes, that were generated in the previous step, are in conflict with certain factors such as technically challenging, increased weight, higher selling price, etc., then the specification must be modified based on other features [7].

7. Perform Economic Analysis (Market analysis): After the completion of the foregoing activities, another significant part of product design process is economic indicators such as development expenses, manufacturing costs, and selling price. In this part, the necessary investment should be estimated. It is important since the economic analysis is crucial for the development process. An economic model of the product and a review of anticipated development expenses in relation to expected benefits are developed at this stage [7].

8. Plan the Remaining Development Project (Plan for production): In the final stage, design team will conclude all the information gathered from foregoing steps and scheme out a detailed progress plan which includes the list of future activities, the necessary resources and estimation of expenses, and a development schedule with milestones for tracking the progress [7].

Below figure shows important categories of product design methodologies and their corresponding concepts and properties. (Figure 2.1)

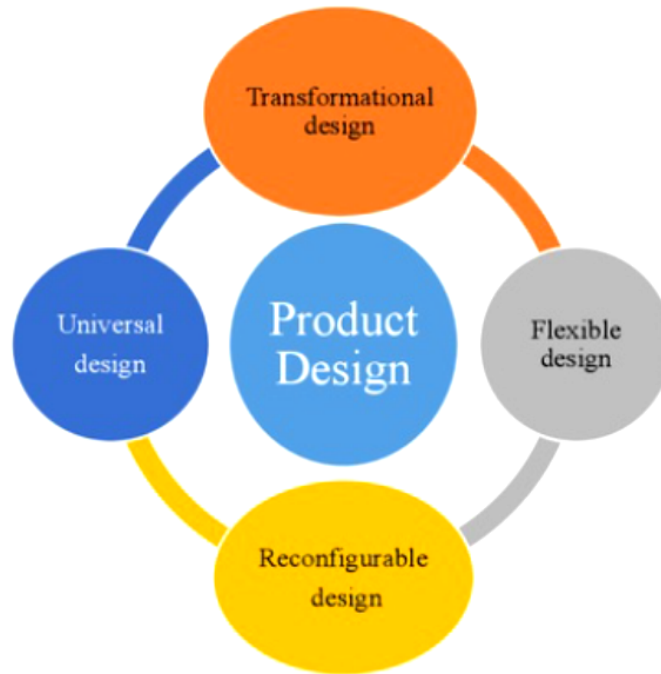

FIGURE 2.1: Schematic of product design categories

### 2.3.1 Universal Design

The term "universal design" originated in architecture, coined by Ron Mace in the 1970s [18]. Universal design has been widening the range of field and enhancing usability of consumer products. However, universal design makes the product and environment to suit virtually to everyone [19], with high usability for each special need. For example, "installing standard electrical receptacles lower than usual from the floor so that they can be reached easily by everyone; and storage spaces within reach of both short and tall people" [20]. However, in some cases, universal design method could lead to some shortcomings. For example, installations of sensors in a business facility, that would signal the door opening anyone approaching to it, could adversely affect the security of the building [19].

During application of the universal design principles, new types of products or services satisfy the needs of potential users with variety of characteristics in a wide range. Therefore, all characteristics should be considered when developing a product or service. These characteristics, which are known as the main seven principles of universal design that should be applied in design process, are as follows: (1) equitable use, (2) flexibility in use, (3) simple and intuitive use, (4) perceptible information, (5) tolerance for error, (6) low physical effort, (7) size and space for approach and use [19]. Figures 2.2 and 2.3 illustrate examples of universal design around the world.



FIGURE 2.2: Stairs accessible to everybody



FIGURE 2.3: Washing machine designed by universal design method

According to Vanderheiden, universal design is the process of creating products (devices, environments, systems, and processes), which can operate within extensive possible scale of situations (environments, conditions, and circumstances) [21]. Universal design has two major components:

1. New products are flexible enough such that they can be used directly (without requiring any assistive technologies or modifications) by people with the widest range

of abilities and circumstances. They are also commercially practical and feasible with current materials, technologies and knowledge.

2. Designing compatible products with the assistive technologies that might be used by those who cannot efficiently access and use the products directly" [21]. The following sub-sections continue to provide a review of different design techniques, which are widely used in engineering design and manufacturing in the last decade.

### **2.3.2 Design for Flexibility**

The word "flexible" comes from the Latin language, meaning "to bend". Another meaning is "ready and able to change so as to adapt to different circumstances" [22]. Defining flexibility is not only crucial for designing flexible products but also an important warranty for the understanding of reconfigurable system design concept. In the early 1990's, Sethi A. K and Sethi S. P identified over fifty definitions of flexibility within the manufacturing domain [23]. Saleh, detecting aerospace systems from the life-cycle aspect, defines flexibility as "the property of a system that allows it to respond to changes in its initial objectives and requirements both in terms of capabilities and attributes occurring after the system has been fielded, i.e. as in operation, in a timely and cost-effective way" [24]. Gupta and Goyal, likewise, have defined flexibility as the ability to change and adapt to a range of states [25]. The proposed definitions by design community for flexibility contain both design and performance spaces. Overall, flexibility is viewed as a functional property, a result of design decisions that can be expressed as a set of principles [26]. Fricke and Moses independently elaborate on these definitions and adding that flexibility is a property characterizing a system's ability to be easily changed [27].

Similarly, flexibility of a product can be defined as the degree of responsiveness (or adaptability) for any future change in product design. Making a design more flexible can enable relative reduction in redesign cost. Product flexibility plays a significant role in responding faster to customer feedback by allowing faster updates in the products and achieving higher levels of performance in a short span of time [28].

#### **2.3.2.1 Methodology: assessing product flexibility**

Change Mode Effects Analysis (CMEA) is one useful tool for measuring the level of flexibility in a product. This work considers product flexibility as a degree of responsiveness to the outside world. It reduces the time consumption for redesign and thereby increases the responsiveness to changing market demands. Flexibility is measured by the number

of parts, functions, modules, interfaces and types of interfaces [29]. There are two steps for assessing the possibility of future changes in a product:

Step 1: Decomposing the product: In this evaluation process, the first step is to decompose the product by using some logical methods so that it can be assessed for possible changes. According to the complexity in a product, decomposition can be done in terms of functions, parts or modules [30]. Decomposing the products based on their functions is also very beneficial for the conceptual design stage.

Step 2: Forming the CMEA table: The second step in this method is to evaluate the "Change Potential Number" (CPN) of a product for possible changes. The CPN provides instructions about the ease for change that can be done in a product. The CPN shows the overall flexibility of a certain change. The inherent flexibility of a design for a given change, the probability of occurrence, and the readiness of the company to react to this change are the main factors that are considered to evaluate the CPN [29].

These are the three main metrics used to determine the CPN of the products. The other columns are supportive columns to help the designer to access these three main metrics. The basic columns in Table 2.1 are explained as follows:

a) Modules/Parts: This column can be components or sub-assemblies or even functions, depending on the complexity of the product under study. All the established parts of a product will be observed respectively and their results will be used for an established CPN by adding them up [29].

b) Potential causes of change: The potential causes of changes for a specific module or part are obtained from the following: a) customer reviews or customer needs of the product, b) a group of experienced designers in that product segment, c) performance goals for the company, or d) market pressure to improve the variety, etc." [29].

c) Potential changes: The potential change(s) that a specific module or part can possibly happen, is documented in terms of the parts and their functions" [29].

d) Potential effects of change: The various effects of a particular change on other parts or functions of the product are documented in this column. These effects can be described as fluctuation, means that, this changes lead to other related parts and functions in the product" [29].

TABLE 2.1: Generic CMEA basic columns

CHANGE MODE EFFECTS ANALYSIS FOR POTENTIAL CHANGES IN PRODUCT DESIGN							
Modules / Parts	Potential Change Mode	Potential Effect of Change	Design flexibility	Potential Causes of Change	Occurrence	Readiness	Change potential number

TABLE 2.2: Generic change modes and effects analysis design flexibility table

Effects	Criteria: Flexibility of the design for a change	Ranking
New product	Very low flexibility ranking- when there is a total redesign (no reuse of parts) of the product, which involves redesign of every single module or component in the product.	1
Total redesign with some reuse of parts	Very low flexibility ranking- when there is a complete redesign or replacement of all most expensive modules in the device that involves substantial cost incurred.	2
Very high level of redesign	Low flexibility ranking- when there is a redesign or replacement of more than one expensive module in the device.	3
High level of redesign	When there is a redesign or replacement of a module, which involves major manufacturing cost.	4
Moderate redesign	When there is a redesign or replacement of a module, which involves considerable manufacturing cost.	5
Low change	When the change involves both parametric and minor adaptive redesign involving considerable cost.	6
Very low Change	High flexibility ranking- when there is only a major parametric change in the parts.	7
Minor	Very high flexibility ranking- when there is a minor parametric change in the parts which can be achieved in very low cost.	8
Very Minor	A very trivial change, which involves almost no cost incurred.	9
None	No effect	

e) Design flexibility: Based on the potential effects of the change from the previous column, the effect of a change to the entire product is rated and contraposed between scale of 1 to 10, as shown in Table 2. A degree of "1" means that the part or function of a practical product has minimum flexibility. A degree of "10" means that the part or function is completely flexible. The product with higher flexibility ranking indicates lower cost for redesigning [29].

f) Occurrence: This column of the CMEA table contraposes on the "Potential causes of changes" column. The probability of occurrence of these changes are also assessed and rated against an interval scale of 1 to 10. Here "1" means there are no or relatively few occurrences, whereas "10" means the change is inevitable. Therefore a product with low occurrence level means, the probability of any future change occurring in that design is minimal, which in turn leads to a less redesign cost [29].

This probability of occurrence may be determined based on the rate of occurrence of these particular changes. These changes can be broadly categorized as follows:

1. Drawbacks or opportunities in the present design [29]. The changes can be assigned as ranking on a scale of 1 to 10 based on customer survey and reviews.

2. Time-dependent change. These changes involve development of new technologies that change over time, the new perspectives, future plans and goals of the company's evolution of this product, various expectations and requirements from the customers on the performance envelope of these products [29].

Table 2.3 shows an example of a generic CMEA occurrence table for rating the time dependent changes. It is difficult to estimate the rank for Occurrence as equivalent

TABLE 2.3: Generic CMEA Occurrence

<b>Probability of Occurrence</b>	<b>No of times in every 10 years</b>	<b>Ranking</b>
Very high and is almost inevitable	10-9	10-9
High: Repeated occurrence	8-7	8-7
Moderate: Occasional occurrence	6-5	6-5
Low: Relatively few occurrences	4-3	4-3
Remote: Unlikely to occur	2-1	2-1

TABLE 2.4: Generic CMEA Readiness

<b>Readiness</b>	<b>Ranking</b>
Completely prepared	10-9
High	8-7
Moderate	6-5
Very low preparedness	4-3
Completely unprepared	2-1

to the number of expected changes in ten years. The ways for identifying the value for occurrence could be on the basis of the type of product and its circumstances.

g) Readiness: In this column of the CMEA table, the readiness of the company for this particular change is assessed and rated against an interval scale of 1 to 10. "10" means the company has maximum preparation to be advanced with this change, while the rank of "1" means the company has relatively small preparation or completely unprepared for this change. If readiness ranking is high in the product, the amount of redesign cost will be low for any future change. Thus, a product with high readiness ranking is more flexible for a given change when compared to its counter part [29]. An example of a generic CMEA readiness table is shown in Table 2.4. The application of flexibility to engineering design certainly has important implications about adaptability of products to technological changes.

### 2.3.3 Transformational Design

Transformational design method is one of the most popular design concept with a wide application domain. A transformation is a process in which an object changes its form gradually in order to obtain another form. Transformational design theory defines a transformer as a system that changes its state in order to facilitate a new functionality or enhance an existing functionality [31]. Products with transformation into various states enable to have higher flexibility and functionality in a single system. The main advantages of transforming products are taking less space and being more convenient than separate products. In well-designed transformational products, each state should provide what the user needs at the time, without tacking on unnecessary factors such as



space, weight, or complicity. However, poorly designed transformers can easily become too complex, unhandy, or confounding [32]. Products, which transform to open new functionality, have been a source of charm and practical properties for centuries. Transformers currently cover many domains, ranging from simple multifunctional furniture or daily tools, to expensive and complex military hardware.

Transformer products can provide improvements in efficiency, convenience, and user-friendliness compared to multiple offerings of products with a single primary-function focus. Compare with a single incarnation, but with multiple states, a transformer product provides an expanded design envelope that can result in several types of improvements as described below [31]:

- Sales price could be reduced when compared with the cost of a set of single function devices.
- Benefits can be achieved in weight- and/or size-sensitive applications.
- Transformational design could be a solution for designing products that serve multiple functions with conflicting parameters, which affect the functions, to be separated in time.
- Certain transforming devices could perform functions between states that are not possible in single-state products.
- Deployment time and complexity can be reduced for many designs [31].

#### Transformation principles and facilitators

The principles and facilitators of transformation assist to specialize the existing incarnation and generate new type of transformer. After studying thousands of transforming products in different fields, the set of three transformation principles and twenty facilitators were found to appear to span the entire space [13].

##### **2.3.3.1 Principles**

A transformation principle is a generalized directive to bring about a certain type of mechanical transformation. It represents the type of transformation taking place and reconstruction to a new form [32]. Principles are description of duality between the states of a system and a product.



FIGURE 2.4: Examples "expand/collapse"



FIGURE 2.5: Examples "expose"

- Transformational Principle No. 1- Expand/Collapse: It takes place through changing physical dimensions of an object to increase or decrease its occupied space/volume in a plane or in three dimensions. Some products, which possess dismountable or deployable structures, are capable of automatically or through mechanical process varying their form from a compact, packaged configuration to an expanded, operable configuration. In Figure 2.4 (left), the portable sports chair expands for sitting and collapses for storable or carriable configuration. In Figure 2.4 (right), the puffer fish expands its body to resist the enemy [33].
- Transformational Principle No. 2- Expose/Cover: Reveal or cloak a new surface to switch its function. In other words, this principle is an indication of changing the surface or some part of an object to alter its functionality. This alteration can be operated by a part-to-part interaction and/or throughout entire form of the object itself. In Figure 2.5 (left), the chair rotates and exposes new surfaces to become a stepladder. In Figure 2.5 (right), the Day-blooming water lily opens during the day to expose its interior, and closes at night [33].



FIGURE 2.6: Examples "fuse/divide - audio player/ USB flash drive "

- Transformational Principle No. 3- Fuse/Divide: A single functional device becomes two or more devices by dispersing. At least one part has its own unique functionality defined by the state of the transformer, or vice versa. Figure 2.6 shows an audio player, which can also function as a USB flash drive or a memory stick. It connects to a power source module making the audio player portable [33].

### 2.3.3.2 Facilitators

A transformation facilitator is a specific means of movement or change that aid the transformation process [33]. Transformation facilitators aid in the design for transformation, but the transformation cannot be carried out only by facilitators. At least one principle should be implemented with other facilitators [33]. In other words, principles describe what leads to transformation, while facilitators describe what makes the transformation function fully and efficiently. A detailed explanation of transformation facilitators is presented below:

- Common core structure: This facilitator can be defined as a device that consist of a core structure (the main support structure) and allows calibration/positioning different secondary level parts of a device or system. In Figure 2.7 (left), the core structure of leaf blower's (working organ) maintains the same implement, while the usable appliances change the operation of device from a blower to a vacuum [33]. In Figure 2.7 (right), the reproductive termite begins its life as a crawling insect,

then grows wings to leave the colony, and sheds its wings to take the roll of a queen of a new colony.

- **Composite:** This facilitator constitutes a single part by combining two or more parts with distinct functionalities. In some devices the parts that form the combination structure might not have individual functions until arranged together. In Figure 2.8, the blunt edge of a utility knife forms a handle out of its cutting utensils when they are not in use [33].
- **Conform with structural interfaces:** This facilitator statically or dynamically constrains the motion of a component using structural interfaces. In essence, the parts conform to other parts to bring out a transformation of a device to produce distinct functionality. In Figure 2.9 (left), flip phones keep their open mode by constraining the motion of the headset section. In Figure 2.9 (right), the kangaroo uses its tail as a structural member that interfaces with the terrain to provide more support while standing [33].
- **Enclosure:** This facilitator operates object in three dimensions. Conversion of an object's functionality can be achieved by manipulating its geometric shape in space. For instance, Figure 2.10 presents this facilitator in a flat cardboard, which is folded and creased to enclose space and store objects [33].
- **Fan:** It is ability to control an object in two dimensions to create an extension, horizontal scattering, or enclose space to switch its function. Figure 2.11 (left) shows a hand fan, which fans out to enclose a volume such that it can be transformed into a hat for providing shade. In Figure 2.11 (right), the frilled lizard fans out its large thin frill around its neck to intimidate its enemies by appearing larger [33].
- **Flip:** Performing different functions based on the orientation of the object. In other words, it implies facilitation of a distinct functionality by re-orienting the object and making it have a different interacting surface. As shown in Figure 2.12 (left), the hand held light is flipped to expose its solar cell array and interface with the handle. In Figure 2.12 (right), an otter's belly, when floating upside down, functions as a horizontal support surface for carrying young or preparing food [33].
- **Fold:** This facilitator is about relative motion between parts of object by hinging, bending, or creasing. This relative motion rearranges the geometric form of an

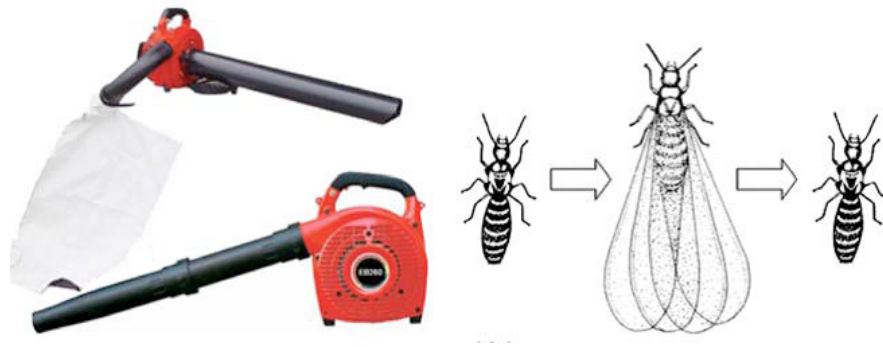

FIGURE 2.7: Examples Common core structure

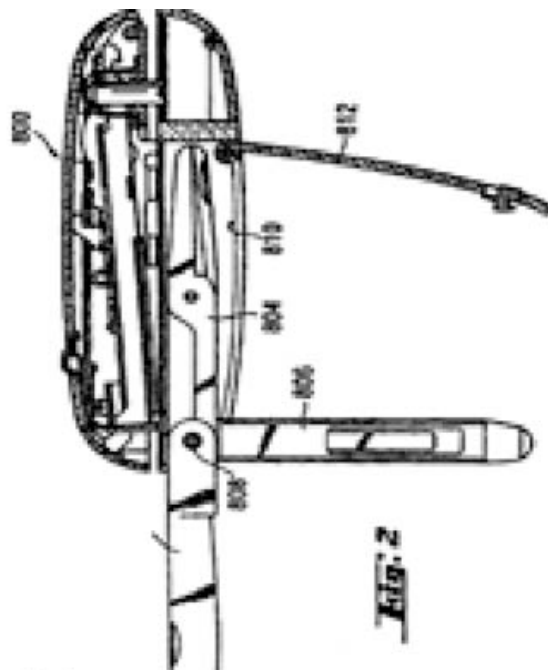

FIGURE 2.8: Examples Composite



FIGURE 2.9: Examples "conform with structural interfaces"



FIGURE 2.10: Examples "enclosure"

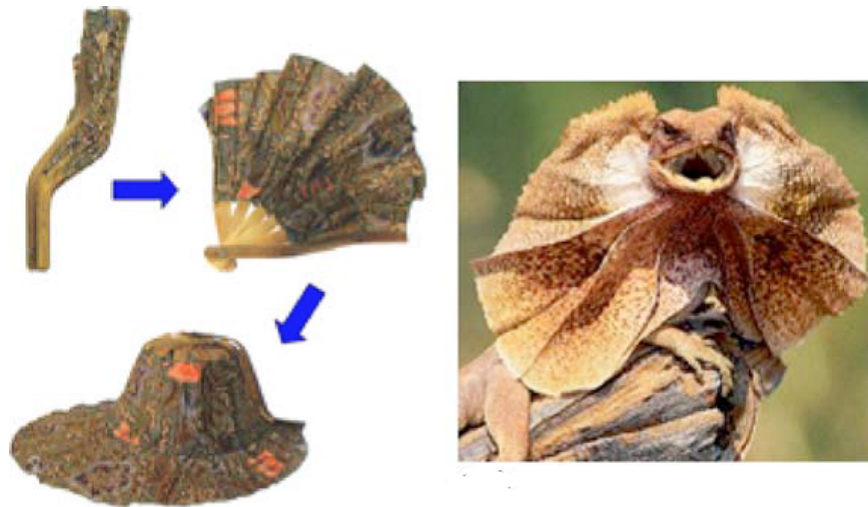

FIGURE 2.11: Examples "fan"

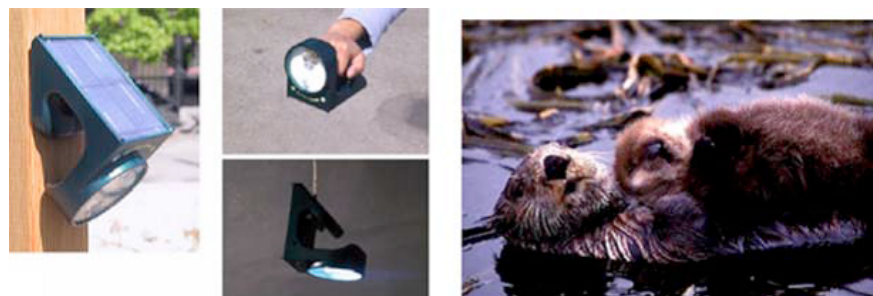

FIGURE 2.12: Examples "flip"

object's parts, facilitating an alteration in the object's energy, material, or signal flow interaction. Figure 2.13 (left) shows the conceptual transition car, which has wings folded toward its body, thus it can be transformed to a small aircraft from a normal car. In Figure 2.13 (right), the bird folds its wings, when lands on a tree or landscapes for food, to change its speed suiting its needs during flight [33].

- **Function sharing:** Executing two or more inconsecutive functionalities. The transforming equipment composed of parts that have two or more functions. In essence, a part or a part of a device performs a primary function in one configuration and performs a different primary function in another state of the device function shifting. In Figure 2.14, the RIMS of the rear wheels of this amphibious toy car become propellers in an alternative configuration of the wheels [33].
- **Furcation:** Switching between two or more discrete stable forms determined by the limit levels. A transforming product consists of various stable states, and the transition between these states is preceded by the bounds forced on it. In Figure 2.15 (left), the common slap bracelet toy is an example of a bi-stable structure that is stable in its extension state. When its transverse plane is flattened, it collapses to a coiled state. In Figure 2.15 (right), a Venus fly trap snaps its leaves shut in about one-tenth of a second, by reversing the curvature of its leaves releasing stored energy [33].
- **Generic connections:** Internal or external links (structural, power) connect different modules of performing different functionalities or performing the same function by utilizing different means. In Figure 2.16 (left), the poles and connectors in this product form different structures using quick connections. In Figure 2.16 (right), identical synaptic connections between two brain cells can result in different end effects, depending on the different connection configurations [33].
- **Inflate:** Padding an elastic enclosure with fluidic component (gas, liquid) to change object's ability. Normally function alteration is induced by changing the material components from solid state to a flexible state. Figure 2.17 (left) shows the inflatable antenna experiment IAE deployed in space. The non-inflatable version of this antenna would have taken a large amount of cargo space in the space shuttle. In Figure 2.17 (right), the puffer fish shows larger than normal status by inflating its body and stiffen the spikes on its body to ward off and escape predators [33].





FIGURE 2.13: Examples "fold"



FIGURE 2.14: Examples "function sharing"



FIGURE 2.15: Examples "furation"





FIGURE 2.16: Examples "Generic connections"

- **Interchangeable transmission:** Generating various motions by using different transmissions. Transformation can be facilitated by altering the relative means of transmission in original motion. Figure 2.18 (left), Black and Decker's multi-tool has one central motor, which is placed inside of the body/handle. The attachments such as sander, drill, and jig saw, have different transmissions to produce various types of motion with the corresponding work piece like sanding, sawing, or drilling. In Figure 2.18 (right), the transmission changes from a wheel to a ski to generate a rotating motion and a sliding motion, respectively, which can deal with different conditions [33].
- **Material flexibility:** Changing the magnitude of an object to orient in different conditions. Replacing the surface structure of an object by a flexible surface material enables it to be stretched in length or proportion based on the direction of exerted forces on the object. This kind of change can facilitate or produce new functions and assist in transformation of the object. Figure 2.19 (left) shows the morphing wing concept is utilized at The MQ-9 Reaper UAV to perform various flight characteristics. Figure 2.19 (right) shows cobra's hood, which has flexible skin to dilate in a hood around the cobra's neck to threaten its enemies [33].
- **Modularity:** Integrating related functions into product modules. Modules with distinct potential functions are integrated from machines, assemblies, or components to accomplish an overall function. In Figure 2.20, the tool set changes functionality as different modules are attached [33].
- **Nesting:** Placing an object into another object entirely or partially wherein the internal geometry of the containing object is similar to the external geometry of the contained object [33]. Figure 2.21 (left) shows water fountain drinking cup

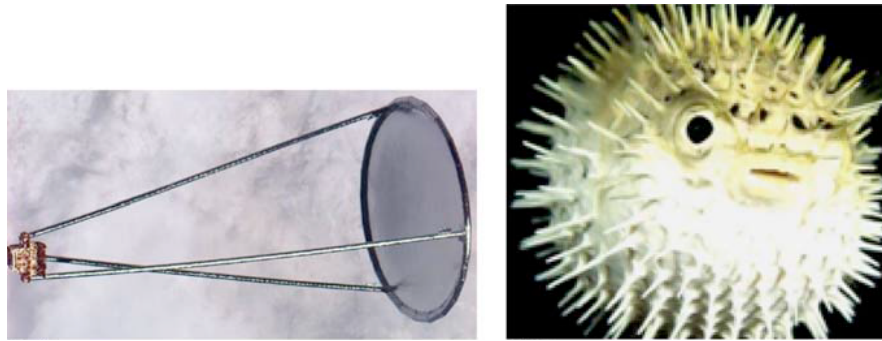

FIGURE 2.17: Examples "inflate"



FIGURE 2.18: Examples "interchangeable transmission"



FIGURE 2.19: Examples "material flexibility"

cones nesting for easier storage. In Figure 2.21 (right), sharks have nested sets of teeth. If one is lost, another spins forward from the rows of backup teeth [33].

- Roll/wrap/coil: Changing an object's function by covering its geometrical feature around an axis to create or enhance curvature. A new object can be generated with a different functionality. For example, Figure 2.22 (left) shows a variable camber wing concept, where actuators change the camber of a wing, and thereby affect the aircraft's lift and flight trait and quality. Figure 2.22 (right) shows an example



FIGURE 2.20: Examples "modularity"

from nature that an armadillo rolling up to a defensive state, where its top armored skin now encapsulates most of its body [33].

- Segmentation: Making a division of single conterminous part to produce independent parts that can be operated to induce a physical reconfiguration. In Figure 2.23, the transformation of a ruler facilitated by segmentation so that its independent parts can be a gemel and spun to fold the ruler in a succinct shape [33].
- Shared power transmission: Power transmission is carried out from a centered source to produce various functions in different form or allocation. Power is delivered from a single centered source such as, an engine, motor to execute detached tasks in different configuration. In Figure 2.24 (left), the Bell Boeing MV-22 Osprey uses a common engine for both vertical and horizontal motion. In Figure 2.24 (right), bats use their fore limbs as wings during their flight motion and as legs in the motion on the ground [33].
- Shelling: Inserting an additional object with a different function into a device. Shell or cover a section or part of an object inside itself within another object. In figure 2.25 (left), a blade is inserted within the shaft of the cane. In Figure 2.25 (right), turtles hide within their hard shells to protect themselves from predators [33].
- Telescope: Operating an object along one particular direction to make an extension or enclosure to change its functionality [33].

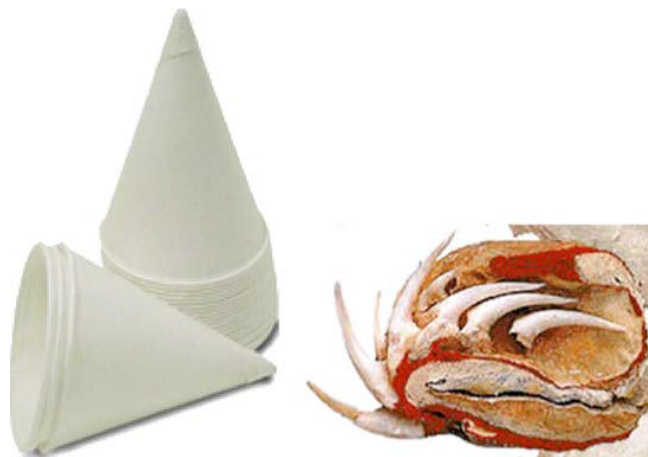

FIGURE 2.21: Examples "nesting"

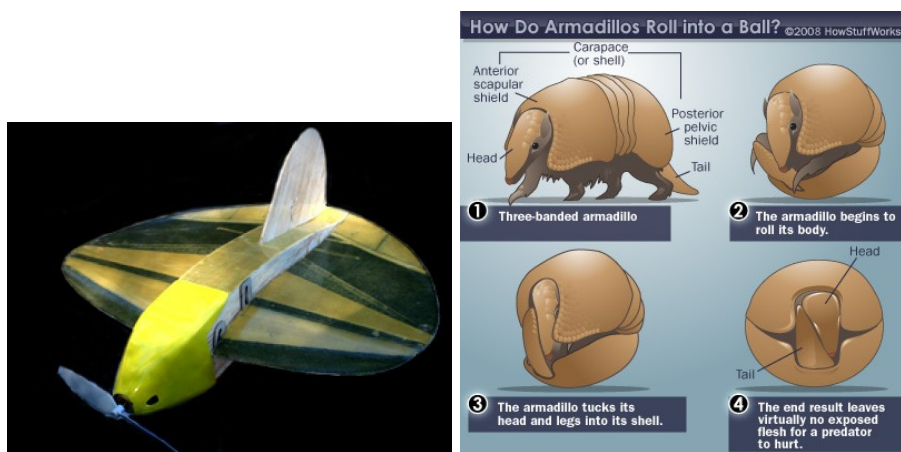

FIGURE 2.22: Examples "Roll/wrap/coil"



FIGURE 2.23: Examples "segmentation"





FIGURE 2.24: Examples "shared power transmission"



FIGURE 2.25: Examples "shelling"

The principles and facilitators serve as valuable tools to generate concepts harnessing the potential of transformation in the mechanical domain [33].

#### 2.3.4 Design by analogy

An important support in assisting the development of innovative ideas is the application of analogies, which are ideas from one domain and re-used in another area to solve a new problem. The analogies can be visual or functional or some combination of the two. Figure 2.26 illustrates an innovative design based on analogies (e.g. a fuel cell bipolar plate). A plant or tree leaf provides a useful analogy for a bipolar plate of a fuel cell, because of its similarity in functionality. The capacity of a fuel cell to generate current is determined by the function chain, namely distributing, guiding, and dispersing the fluid. This functional chain also appears in a plant leaf. The leaf analogy is appropriate and powerful such that the veins perform the functions of distributing and guiding the fluid; and the lamina dispersing the fluid [34].

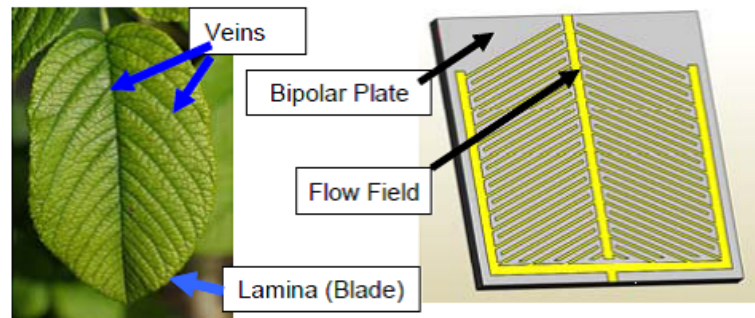

FIGURE 2.26: Fuel cell bipolar plate design generated from a leaf analogy

### 2.3.4.1 Definition of Analogy Design

Analogy design as defined by Qian and Gero is the use of features from an appropriate object for a design problem. This definition is effective but incomplete. Since there is another similar concept named metaphors for design. For a more general definition of analogies and metaphors extending beyond the design realm, Gentner and Markman define the concepts within the space of two dimensions, relational similarity and the number of attributes shared [35], (Figure 2.27). Metaphors are commonly used to represent users' understanding, activities, and reactions to a product. They form a consciousness in customers mind for their needs by extracting from source of an inspiration. However, analogy chiefly represents the causal structure between the existing products in one domain to the target design problem being solved [35].

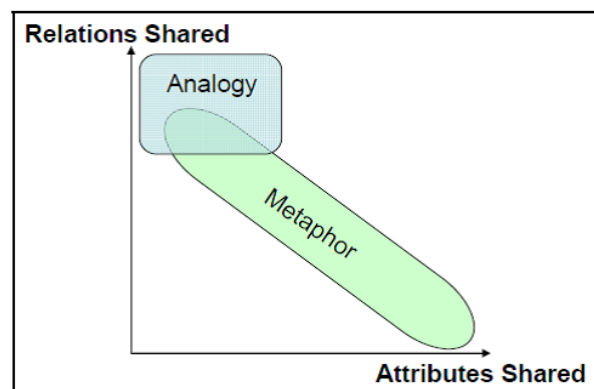

FIGURE 2.27: Definition and relationship between analogy and metaphor as presented by Gentner and Markman

### 2.3.4.2 Analogies Using Nature

Nature is the source of innovation, and examples of this are commonly found. Figure 2.28 and Figure 2.29 represent two fantastic designs based on nature. Figure 2.28 shows a

new design for sails on cargo ships, which enable reduction in fuel costs. The inspiration of the sail design comes from the structure of a bat's wing. A small size prototype model represented on the boat (on the left). The center is a conceptual illustration of the design's intended use on a cargo ship [35].



FIGURE 2.28: The sails of this cargo ship are designed based on an analogy to a bat's wing.

Nature provides unlimited keys for solutions in unexpected places and thoroughly different circumstances. One example is a maneuverable space suit (Figure 2.29) enabling outer space exploration easier and more effective. Inspiration comes from the giraffe's legs for solving this case. The tight skin on a giraffe's legs assists in regulating blood pressure. A prototype design for a new space suit was based on this principle. Figure 2.30 provides an example of analogy being used from the sea. The analogies representing an underwater robot being used to collect lumber are visually very similar to a sawfish [35].

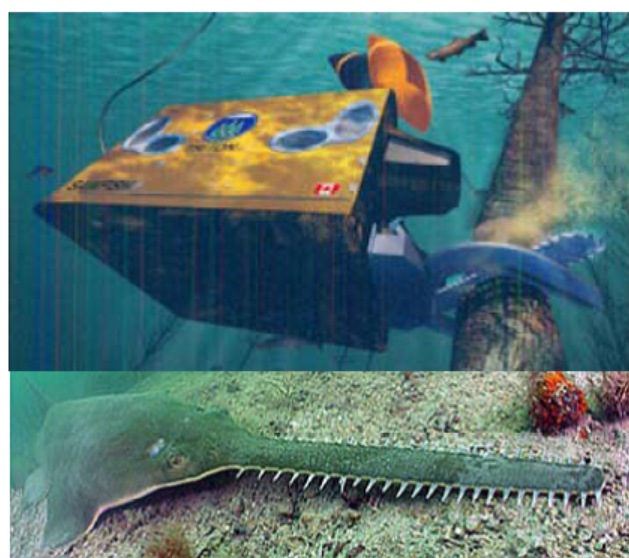

FIGURE 2.30: An analogy to the sawfish- an underwater robot designed to harvest lumber from reservoirs.



FIGURE 2.29: The ultra maneuverable and lightweight space suit, partially inspired by the tight skin of a giraffe's legs, which helps to regulate blood pressure. It relies on mechanical pressure rather than gas pressure to support human life in a thin atmospheric environment such as Mars

The sawfish and the underwater robot are visually similar, but they share very minimal functional similarity. The more likely analogy for the design of the underwater robot is a chain saw [35].

### 2.3.4.3 Biological Analogies for Design

Biomimetic design is a process that uses biological analogies to exploit new design concepts. Therefore, biomimetic design is one of the most appropriate fields for creative analogies. The knowledge constructed within natural-language format to establish biomimetic design to dispel the needs for innovation and keep enormous database of biological phenomena and analogies for engineering design objective [36].

Biological analogies lie somewhere between related and unrelated stimuli [37]. The analogies are exploited on account of similarity of function, and are thus related. However, analogies discovered at different levels of the biological organization as shown in Table 2.5 could be quite abstract [37].



TABLE 2.5: Biological Organizational Levels

Organizational Level	Definition	Examples
Molecule	Two or more atoms joined by covalent bonds or ionic attractions.	Proteins, DNA, enzymes
Organelle	One of several formed bodies with specialized, functions suspended in the cytoplasm found in eukaryotic cells.	Mitochondrion, cell nucleus
Cell	The lowest level of organization where all the properties of life appear.	Neuron, red blood cell
Tissue	An integrated group of cells with a common structure and function.	Brain tissue, muscle tissue, bone
Organ	A specialized center of body function composed of different types of tissues.	Brain, kidney, heart
Organ System	An organized group of organs that carries out one or more body functions.	Nervous and digestive systems
Organism	A complete living being composed of one or more cells.	A deer, tree, single-cell organism
Population	A group of individuals of one species that live in a particular geographic area.	Bacterial culture, all deer in forest
Community	All the organisms that inhabit a particular area.	All animals, plants, acteria,,fungi etc., in a particular area
Ecosystem	All the organisms in a given area with the abiotic factors with which they interact.	A forest, a pond
Biosphere		Planet Earth

#### 2.3.4.4 Types of similarity relationships

The type of similarities between biological phenomena and the concepts developed are influenced by the types of data represented in description of the phenomena. Here, four types of similarities for the biological phenomena are presented:

##### Literal Implementation

The first type of similarity relationship is characterized by literal implementations of biological phenomena. For example, using bacteria (source domain) for filling pores of clothing (target domain) such that dirt cannot settle. Here, the strategy that has been implemented is the same as that presented, but the same biological actors, bacteria, execute the strategy, i.e., no abstraction of biological entities was implemented [36].

##### Biological Transfer

The next type of similarity does not implement the strategy presented, but it remains fixated on the domain of biology by transferring the biological actors of the phenomenon to another strategy. Responses of this category include immersing the garment in a pool of bacteria that will eat grease and stains. The bacteria (source domain) are used to solve the problem of dirty clothes (target domain) by eating grease and stains [36].

##### Analogy

The third type of similarity relationship implements strategic principles derived from the biological phenomena without transferring the biological actors. A response obtained from this category incorporates the strategy of "competition for space" and replaces bacteria and fungi (source domain) with a saturating solution (target domain), such that the settling of stains cannot occur. This category represents the type of similarity intended in biomimetic design [36].

##### Anomaly

An anomaly does not involve any apparent similarity between the concept and the biological phenomenon on which the concept is based. An anomalous concept could be developing a material that reacts with air to clot puddles on sidewalks. While the reasoning behind in many such concepts is unclear, some responses of this category are due to misinterpretation of the phenomenon leading to the extraction of incorrect strategies [37].

## 2.4 Reconfigurability and Reconfigurable Design

Reconfigurability is a relatively new area of interest in research community. In general, reconfigurability is the ability to repeatedly change and rearrange the components of a system in a cost-effective way [38]. Even though the majority of the concepts regarding reconfigurability are just recently generated, but the example of a folding fan, which was invented in Japan back in the 7th century [39], tells us that people have been using reconfigurable concepts and products for centuries. Reconfigurability contains properties allowing the object to make a good adaption to various circumstances such as different customer needs, variation of new technology, and changing environment. Based on these, reconfigurability is used as a particular strategy for meeting various needs in many areas. Similarly, according to Siddiqi, reconfigurable systems achieve a desired outcome within acceptable reconfiguration time and cost [39].

Reconfigurability is extensively applied in many research areas and implemented in many application domains. Here, three areas will be presented; namely reconfigurable manufacturing systems, reconfigurable modular robot machines, and reconfigurable product design.

### 2.4.1 Reconfigurable manufacturing system (RMS)

The two main traditional methods used by manufacturing industries in the production of medium and high volume parts are; dedicated manufacturing systems (DMS) and flexible manufacturing systems (FMS) [40], [41]. (i) DMS: Typically, machines used in DMS are designed to perform a single operation with high reliability and repeatability, and high productivity, hence they are relatively simple and inexpensive [42]. (ii) FMS: Machines used in FMS are designed to perform most operations in a flexible manner and computer numerical controlled (CNC), and thus many different parts can be produced by changing the computer programs. However, flexible machines designed for high volume production are relatively expensive due to their required high reliability, repeatability, and high productivity for mass production lines [42]. RMS as a new class of system with a cost effective manufacturing approach can easily respond to rapid market changes. RMS has the main objective of using modules or parts of a system that can be rearranged rapidly for the quick integration of new technologies into existing systems [43]. RMS combines not only high production capacity of a Dedicated Manufacturing Lines (DMLs) with the flexibility of FMS, but also the capability of responding to market changes by adapting the manufacturing system and its elements quickly and efficiently [44]. Figure 2.31 illustrates that capacity and functionality can be changed exactly in RMS when the change is required. However, the capacity and functionality of DML and FMS are

normally fixed in their systems. RMS is not limited by capacity or functionality. One major quality of RMS is the ability of change over time and allowing the object to make a good adaption to variation circumstances.

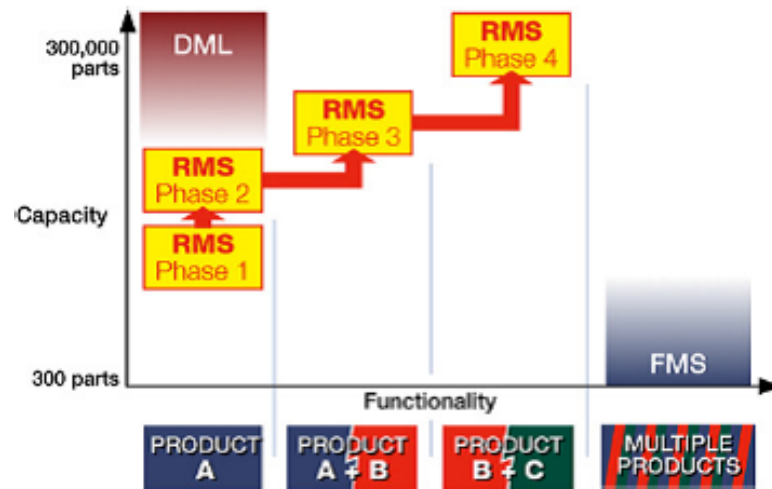

FIGURE 2.31: Both DML and FMS are static, but RMS is dynamic with capacity and functionality flexibility in response to market demands

Reconfigurable manufacturing systems are designed according to the reconfiguration principles [45]. These principles need to be considered for the purposes of avoiding unpredictability, unexpected occurrences, changes, and system events by improving reconfiguration speed and consequently speed of responsiveness [42]:

1. An RMS system provides adjustable production resources to respond to the unpredictable market changes and intrinsic system events:

- RMS capacity can be rapidly scalable in small increments
- RMS functionality can be rapidly adapted to new products
- RMS built-in adjustment capabilities facilitate rapid response to unexpected equipment failures

2. An RMS system is designed around a product family with just enough customized flexibility to produce all members of that family.

3. The RMS core characteristics should be embedded in a system as a whole, as well as in its components (mechanical, communications, and control)" [42].

In literature, there are six core reconfigurable characteristics identified which are summarized below:

Customization (flexibility limited to part family): System or machine flexibility is limited to a single product family, thereby obtaining customized flexibility.

Convertibility (design for functionality changes): The ability to easily transform the functionality of existing systems and machines to suit new production requirements.

Scalability (design for capacity changes): The ability to easily modify production capacity by adding or subtracting manufacturing resources (e.g. machines) and/or changing components of the system.

Modularity (components are modular): The compartmentalization of operational functions into units that can be manipulated between alternate production schemes for optimal arrangement.

Integratability (interfaces for rapid integration): The ability to integrate modules rapidly and precisely by a set of mechanical, informational, and control interfaces that facilitate integration and communication.

Diagnosability (design for easy diagnostics): The ability to automatically read the current state of a system to detect and diagnose the root causes of output product defects, and quickly correct operational defects [46].

Having presented the main characteristics and principles of RMS, the next section will discuss reconfigurable modular robot machines.

### **2.4.2 Reconfigurable modular robot machines (RMs)**

A representative reconfigurable manufacturing system contains both conventional flexible machines mentioned in the previous section and a new type of machine called reconfigurable machine (RM). Self-reconfigurable means that the system can transform into various shapes by changing the connections between the modules without any external help. One major benefit of the self-reconfigurable system is its self-repair, i.e. the system itself can switch out a damaged module with a spare one [47].



FIGURE 2.32: A self-reconfigurable robot

When high volume production line reliability, repeatability, and high productivity are necessary, the flexible machines are relatively expensive. However, the RM is designed for customized flexibility, i.e., the flexibility is needed to produce a particular part family [42]. An RM is a specifically designed machine that can meet product variants within a specific part family. The main properties of RM design are to make the changeover procedure simple and efficient. Development of new design principles based on RMs and its six core characteristics was required in order to design RMs [42]. Necessary and primary principles of RMs design are described below:

Necessary principle:

1. A reconfigurable machine is designed around a specific part family of products" [42]. This principle is necessary for defining a machine as a RM. The following principles are important for specifying main characters of the RMs.

Primary principles:

2. A RM is designed for customized flexibility only. That means a machine can include constrained flexibility that only related to several specific properties as required from the design specifications [42].

3. A RM is designed for easy and rapid convertibility. Designer should consider the configuration designing to make it easy and fast in changing of machine elements, rapid addition or removal of elements [42].

4. A RM is designed for scalability. It should allow addition or removal of elements to enhance productivity or efficiency of operations [42].

5. A RM is designed to allow utilization of reconfigurability of machines to operate at several positions along the production line. Moreover, the RM will be configured to perform different specific tasks at each position, using the same basic structure (RM can include different structural (hardware) elements) [42].

6. A RM should be designed for modularity, i.e., using common building blocks and common interfaces. Modularity should allow machine to perform rapid reconfiguration. Standard electrical, mechanical, control, and software interfaces should allow rapid integration of common elements or building blocks, which were predesigned or selected [42].

According to some literature, RMs are classified into reconfigurable machine tools, reconfigurable featuring systems, reconfigurable assembly systems, reconfigurable inspection or calibration system, and reconfigurable material-handling system [48]. Here, reconfigurable machine tools (RMTs) and its applications in RMs will be presented. The role of a machine tool is to perform material removing/adding operations to complete the desired specific task. However, machine tools are traditionally used to increase amount of product variety by the specific machine builders for each type of product. Therefore, the users have to purchase each of the machine tools with a specific configuration. As referred in the description of the RMs, reconfigurable machine tools are designed with customized flexibility, which combine the high productivity of DMs and the flexibility of CNC machines [46].

One example of RM is an arch type RMT, shown in Figure 2.33. It was built around a part family of products with inclined surfaces and designed for a mass production line for both milling and drilling on inclined surfaces [42]. It was built for a part family (Principle 1) with inclined surfaces found in V6 and V8 automotive cylinder heads shown in Figure 2.34. This was built for customized flexibility only (Principle 2), the inclination angle changes between 15 degrees and 45 degrees in steps of 15 degrees [49], as shown in Figure 2.34.



FIGURE 2.33: The arch type RMT

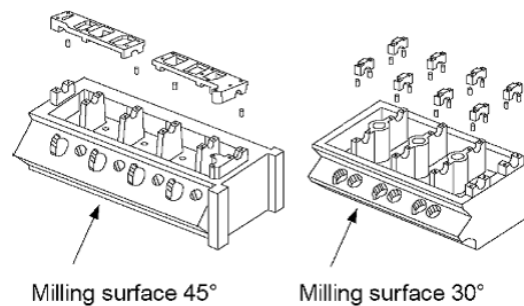

FIGURE 2.34: RMT part family, two automotive cylinder heads: V-8 (left) and V-6 (right)

Until now, I have stated the reconfigurable manufacturing systems and reconfigurable modular robot machines, which are the application domains taking full advantage of reconfigurability. In the next section, I will present the reconfigurability aspects in reconfigurable product design.

### 2.4.3 Reconfigurable product/system design

There has been a significant amount of research on reconfigurable system design for accomplishing the growing desire for products that can satisfy the various customer needs. Reconfigurable systems have the ability to add, enhance, or change performance through repeatable and reproducible physical changes to their state [50]. These properties allow the object to make a good adaption to variation in circumstances (e.g. different customer needs), variation of new technology and changing environment. One major quality of reconfigurable systems is to enable product changes in configuration repeatedly and reversibly. This means that the pre-designed configuration can be changed at any time.



One key element to reconfigurable systems is that these systems are able to change their configurations both repeatedly and reversibly [50]. As presented in Section 2.3.3, transformation design generates a system in one object that enhances existing functionality by changing its state. There is some similarity between transformer and reconfigurable products. However, they have slight distinction. A transformer changes the state to generate new or enhanced functionality, while a reconfigurable system changes the state to provide a new shape or function. A simple example of a reconfigurable system, that is also a transformer, can be seen in Figure 2.35 [50]. The product can be a chair or a step stool depending on the user's needs and is able to obtain both of these configurations as needed.



FIGURE 2.35: A step ladder is being reconfigured into a chair

According to the earlier studies, reconfigurable product/system can address three main needs.

Main features of reconfigurability

A reconfigurable product can address up to three needs as described below

1. Multi-functionality: The ability of a system to perform multiple functions or obtain varying operating points over time, but not concurrently
2. Evolution: The ability to morph the system into future planned or unplanned configurations
3. Survivability: The ability of a system to partially operate despite a failure in some components or subsystems [51].

Reconfigurability is a particular strategy for meeting various needs with a multi-state product. However, it has diverse added design difficulties, which designers should dispose during the design process. Reconfigurable products are becoming more common as indicated by the number of granted patents in United States over the last 21 years [52]. Figure 2.36 shows the number of patents containing reconfigurability [53]. It can be seen that both the overall number and percentage of patents are continuing to grow.

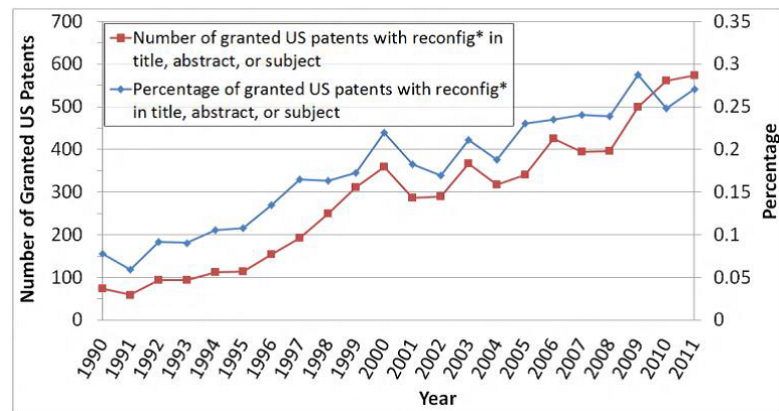

FIGURE 2.36: Number and percentage of granted US patents with "reconfig\*" in the title, abstract, or keywords over the last 21 years

In this section, I introduced couple of design methodologies and their properties. Also, I presented current issues and tendencies regarding the relative design concept. In the following section, I will present different problems and cases for the concerning population group. Furthermore, the need and importance of an integrated product will be discussed.

## Chapter 3

# Identification of a case/product need: Case Study

### 3.1 Problem/Case Statement

Through my observations, I recognized a series of problems, which exist in some furniture products that are used by student and employees at my university. These products are normally used in small areas with confined space, consistently moved around, and indeed need much more flexibility. The places such as the universities, small companies, office work places, student dormitories, student homes strongly need ergonomic design. Therefore, these places were selected as the target places. The interviews have been conducted with different groups including undergraduate students, graduate students, office workers, and secretaries. Based on the interview results, the main furniture features are identified as (1) functionality, (2) flexibility, and (3) ease with which they can be adjusted to continually changing needs and requirements. One of the main issue is that one piece of furniture often possesses a single or a few number of functions, while most practical requirements often need more than one. Thus, these furniture occupy too much space in a confined area, such as secretary and academician offices or student houses and dormitories. Moreover, moving these furniture brings financial difficulties to the users who have very limited incomes such as undergraduate and graduate students. Furthermore, the users prefer more durable, lightweight and cost effective furniture.

In the second step, a furniture product search has been conducted. Based on a walk-through observation in different places, I identified and listed some common furniture including bunk bed, clothes cabinet, coat rack, office desk, drawer unit, valet stand, book shelf, file cabinet, chair, desk lamp, end table and news paper holder. Some of the photo documentations of furniture items from different observed places (student dorms



FIGURE 3.1: Student bunk used in student dormitory



FIGURE 3.2: Clothes cabinet used in student dormitory

and houses, graduate student assistant offices and academician offices) have been given in Figures 3.1-3.5.

Here, I will discuss some potential product needs developed from my initial observation.

Large study table:

During my investigation in office rooms, I observed that large study tables and desks take too much space and they are very hard to move. In addition, they provide very little functionality to users. Thus, these make many problems in space limited areas (unmovable desk Figure 3.6).



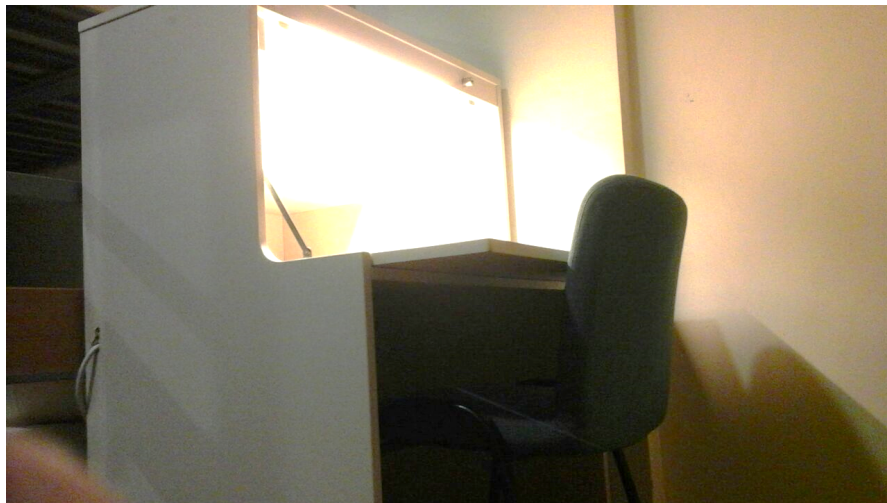

FIGURE 3.3: Study desk with light at student dormitory



FIGURE 3.4: Bookshelf & file cabinet used in academician office



FIGURE 3.5: Coat rack with fixed hooks in student dormitory



FIGURE 3.6: Large study/work desk in an assistant room

Shoe cabinet:

Another one is shoe cabinet used in student houses or dormitories (Figure 3.7). Space constrain is a problem to place the cabinet at a suitable space. Immovability, unconstrained of each layer of cabinet gives them considerable shoe storage problem since they cannot deal with insufficient space for storage. Furthermore, it could not be easily carried or moved. It occupies very large area and has very little functionality for the users. It also adversely affects the compactness and tidiness of the room.



FIGURE 3.7: Shoe cabinet with two layers used in student dormitories

### 3.2 The need for integrated product

An approach that can place people needs at the center of product development is needed. Based on the interviews the furniture items have very minimal functions for the users. Most of the users have implicit needs such as, space saving, compactness, multi-functionality, and cost effectiveness. To respond to these requirements and implicit customer needs, it was determined to proceed with the use of Integrated Product Development (IPD) concepts towards improving product functionality and providing more benefits for the users. My project objective is to integrate different functions on a single product for satisfying the targeted customer needs through implementing different design tools.

I have also conducted a market and patent search of existing products addressing the needs of college students. There are several multi-functional products for bedding, table/desk and chairs as depicted in Figures 3.1-3.5. Hence, I focused my search to identify an actual need towards unaddressed products such as light pole, drawer, hanger, etc., which are smaller and less inexpensive but necessary items for a typical student life compared to beds, desks, and chairs.

### 3.3 Summary

In product development world, as products are rapidly being developed to be more complex and have closer relations with our lives, the interactions and values between different functions of products become an obligatory factor for the development and innovation of product.

Integrated product development concepts are not completely new in design processes. In many aspects of our lives, this concept reflects the effective structure organization of a product or process including interaction effectively between the various functional parts and coordinating their performances with relatively easy actions. Integrated product development concepts represent a modern day approach for addressing the complexity and technology associated with today's new product development.

In this chapter, I have identified potential product needs through investigations and couple of example products have been presented, which are included student bunk, clothes bureau, study desk with light, coat rack with fixed hooks, shoe cabinet used in student dormitory, bookrack & file cabinet and large study/work desk used in assistant office room. Moreover, brief description of the integrated product need has been given. In the next chapter, the related process about targeted product items will be presented.



## Chapter 4

# Integrated Product Design-Implementation of Design Methods

As mentioned in previous chapter, there are many product items either being used in our daily lives or in some organizations with plenty of problems influencing their use. This suggests that we need to explore these problems continually and try to solve them through various innovations on entire body or enhancement on existing functionalities by means of various design methodologies.

### 4.1 Identification of a design problem

Based on observations mainly made through personal experience during a daily life, relatively small size furniture items such as coat rack, drawer unit, valet stand, and different types of lamps, which are commonly used by the university students, secretaries and academicians, were selected for further observation and study.

#### 4.1.1 Target product identification

Coat Rack, a furniture item, which is used in homes, offices and some public places to hang clothes. In some cases, a coat rack refers to a self-standing piece of furniture. The self-standing variant is more often referred to as coat stand and is mostly used to hang coats, jackets, umbrellas, and hats (shown in Figure 4.1). Currently, various types of coat racks exist on the market. However, there is a need to enhance their modularity,



FIGURE 4.1: Walnut finish type of coat rack



FIGURE 4.2: Double-hanger valet stand

adjustability, and portability upon considering factors like, space saving, cost, material usage, convenience, and safety. In other words, improving their functionality is needed by implementing various synthesized design methods.

**Valet Stand:** Valet stand (shown in Figure 4.2) is also called men's valet, clothes valet stand. It is a furniture item used for hanging clothes, especially men's suits. A typical valet stand includes the features such as trouser hangers, jacket hangers, shoe bars etc. Some of the valet stands are also equipped with a tray that can be used for storing watches and jewelry; and they are mostly used in offices, homes, conference rooms, libraries, and laboratories. A valet stand is the simplest and quickest way for keeping and organizing the clothes. If I add a component or assembly to a proposed new product and make it function as a valet stand, this strategy and design ideas would greatly increase their usability. Thus, this strategy will save cost, space, and materials compared to two single products performing separate functions.

**Office Drawer Units:** Every office requires a place to store important documents



FIGURE 4.3: Drawer unit

and accessories, particularly arranging them neatly in an office drawer (shown in Figure 4.3) is necessary. For furnishing executive offices, meeting rooms, and boardrooms the same functional appliances should be used as well. For the same purpose in home, many families are using chest of drawers or nightstand, with similar features as drawer units. It seems either for study or office work, office drawer units are an essential part of the office and home furniture. Now we are going to reassemble or retrofit the product by the related design method to enhance its functionality. In other words, we will make an integrated product performing as an office drawer. This may lead to significant improvements and enhancements in terms of space and cost saving. Moreover, this approach also provides great functionalities and convenience to the clients.

**Table Lamp/Bed Lamp:** In general, the top part of a coat rack is not used. Only for certain special types of coat racks, the top part is designed in a head shape for keeping caps, or set up with a fixed lamp for lighting (shown in Figure 4.4). Consideration of adding a lamp with a flexible arm to the head to direct light is being planned. The arm and head would need to have sufficient flexibility and length. It can light up not only the limited area where the coat rack is placed, but also use it as a table lamp when working or studying on a table by moving the lamp head down. Moreover, the orientation, length, and even the luminance can be adjusted such that it can provide efficiency, productivity, and comfort just like a desk lamp shown in Figure 4.5. When reading in bed, it can also be used as a reading lamp by adjusting the brightness and the length of lamp neck. If you do not want to disturb others when you are taking your coat in the dark room where others are sleeping, you can easily find out your coat by simply lightening the coat rack lamp without switching the room's light. This integration may bring many advantages to customers by virtue of its flexibility and large extended use, as mentioned in some examples above.

As described above, I presented brief information regarding targeted furniture

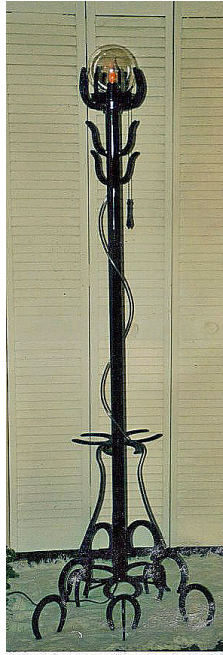

FIGURE 4.4: Coat rack lamp



FIGURE 4.5: Hobby Desk Lamp

and expected improvements through integration. In order to proceed with these improvements, I performed a customer survey for gathering information regarding the targeted products. The information includes problems, needs or requirements, and even suggestions for improvement.

#### **4.1.2 Customer Survey**

Since the client's needs define the purpose of the design, I conducted a survey among our identified customers (university students and staff) for gathering further information about the problems, needs and requirements on each piece of identified product.

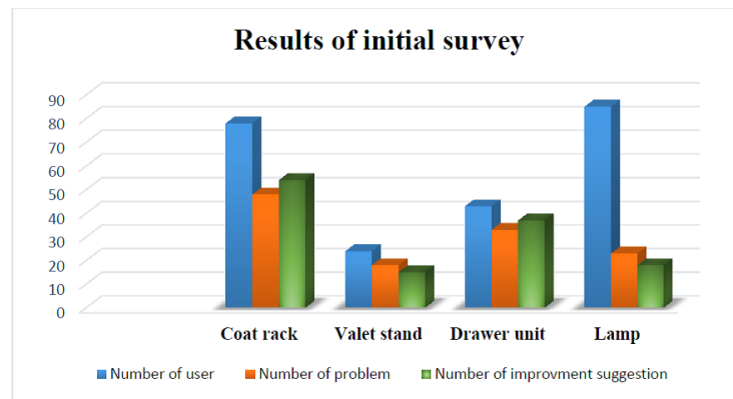

FIGURE 4.6: investigation results about furniture usage (Graph I)

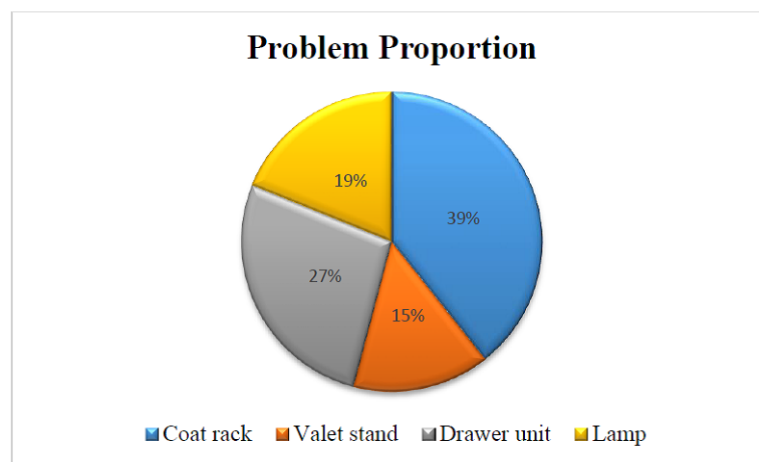

FIGURE 4.7: Problem ratio from survey (Graph II)

According to the questions listed in the Appendix, I surveyed undergraduate students, graduate students, secretaries, and academicians in total of 85 people, regarding the use of furniture items including coat rack, drawer unit, valet stand, and lamp (desk, bed, stand, and hanging lamp). The investigation results are presented in categories such as usage, problem ratio, and improvement suggestion ratio (Graphs I, II, and III).

Survey results showed that coat rack and different types of lamp are the most commonly used furniture among targeted population. Based on the survey, drawer units and valet stand are normally used by office workers and some of the students who live at student houses. Each type of furniture items has their own problems. Moreover, different types of suggestions for improvements, needs, and corresponding requirements have also been given. The problem proportions for each item according to the total number of people are shown in Graph II. The suggestions percentages for each item are shown in Graph III.

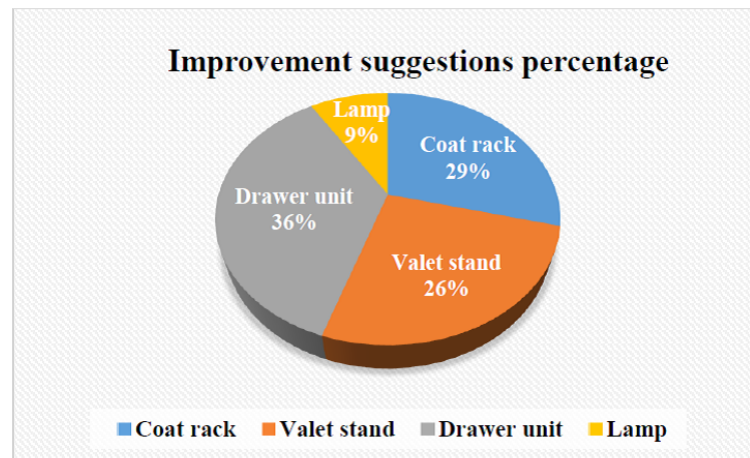

FIGURE 4.8: improvement suggestions percentage (Graph III)

TABLE 4.1: Ranking of problems and needs for each furniture item

Customer Needs	Undergraduate Students	Graduate Students	Academicians & Secretaries
Drawer Unit			
Reliable	5	5	5
Sufficient drawer case	3	4	4
Adjustable size	4	5	5
Adjustable stand leg	4	4	4
Space saving	5	5	3
Efficient surface space using	5	5	5
More functionality	5	4	4
Individual lock	4	5	5
Easy to use	5	5	5
Easy to move	5	5	5
Adjustable height	5	4	4
Suitable weight	5	4	3
Removable drawer case	4	4	2
Drawer cases with different	5	5	4
Attractiveness	5	5	5
Cost effective	5	3	4
Strong and durable	3	5	3

The survey has been conducted both by paper and online survey forms among undergraduates, graduates, and some academicians using 0 to 5 scoring range. The average results of scoring both from online survey and paper based scoring for the main customer needs are shown in Table 4.1, 4.2, 4.3, 4.4.

TABLE 4.2: Ranking of problems and needs for each furniture item

Customer Needs	Undergraduate Students	Graduate Students	Academicians & Secretaries
Valet stand			
Convenient moving	3	4	5
Convenient stacking	3	3	4
Not easily falling down	2	2	2
Durable	3	4	4
Compact	4	4	5
Multi-functional	3	3	3
Adjustable height	4	4	5
Separable part	4	3	2
Suit weight	4	4	4
Surface finish	2	2	3
Space saving	5	5	4
Multi-purpose using	4	4	3
Inexpensive	5	5	3

TABLE 4.3: Ranking of problems and needs for each furniture item

Customer Needs	Undergraduate Students	Graduate Students	Academicians & Secretaries
Coat rack			
Movable	5	5	5
More hook amount	5	4	3
Strong and durable	5	4	4
Flexible hook	5	5	3
Adjustable height	4	4	3
Space saving	5	5	5
Light weight	5	4	2
Multifunctional	5	5	3
Flexible coat rack body	3	3	3
Rotatable coat rack body	3	3	4
Less fell down probability	4	4	4
Inexpensive	5	5	3
Multi shape hooks	3	3	3
Easy to storage	5	4	3
Attractive color	2	4	4

TABLE 4.4: Ranking of problems and needs for each furniture item

Customer Needs	Undergraduate Students	Graduate Students	Academicians & Secretaries
Lamp			
Flexible neck	5	5	5
Adjustable neck length	5	5	4
Adjustable lighting angle	5	5	4
Multi-purpose using	5	3	3
Compact	4	4	4
Adjustable luminance	5	5	5
Separable part	5	4	2
Easy to storage	4	2	1
Easy to assemble	4	2	1
Space saving	3	3	1
Not easy to absorb dust	4	4	4
Inexpensive	5	5	4
Looks good	3	3	4
Lasts long period	5	5	5

These results of the survey will be used in QFD analysis presented in the next section. The needs will be translated into measurable engineering specifications and technical quantities.

### 4.1.3 Quality Function Development (QFD) Analysis

After prioritizing each requirement from the customers by ranking the importance score (from 0 to 5), I selected the main and common requirements and needs. According to these requirements for each targeted furniture piece, I proceeded with a quality function development analysis. Quality function deployment (QFD) is a "method transform qualitative user demands into quantitative parameters, to deploy the functions forming quality, and to deploy methods for achieving the design quality into subsystems and component parts, and ultimately to specific elements of the manufacturing process" [54]. The three main steps in implementing QFD are: i) prioritize spoken and unspoken customer wants and needs, ii) translate these needs into technical characteristics and specifications, and iii) build and deliver a quality product or service including everybody toward customer satisfaction [55]. Before generating the ideal product that deals with the collected customer needs, I translated customer requirements into measurable engineering



specifications and technical quantities. Below is a QFD table for a drawer unit. The other QFD tables are presented subsequently.

Drawer unit:

I proposed couple of design specifications including functionality, modularity, cost, reconfigurability, and weight based on the survey results. The initial target or limit values for each specification are:

1. Functionality: 3 or more (up to 5) different functions will be included for contraposng each demand quality;
2. Modularity: 3 to 5 models for using;
3. Cost: The target price would be between \$25 and 40 according to the customer's expectations and my prediction;
4. Reconfigurability: 4 to 6 configurations;
5. Weight: As a one component of the final integrated product, the weight scale is expected and controlled between 6 kgf and 10 kgf.

The details are given in Figure 4.9.

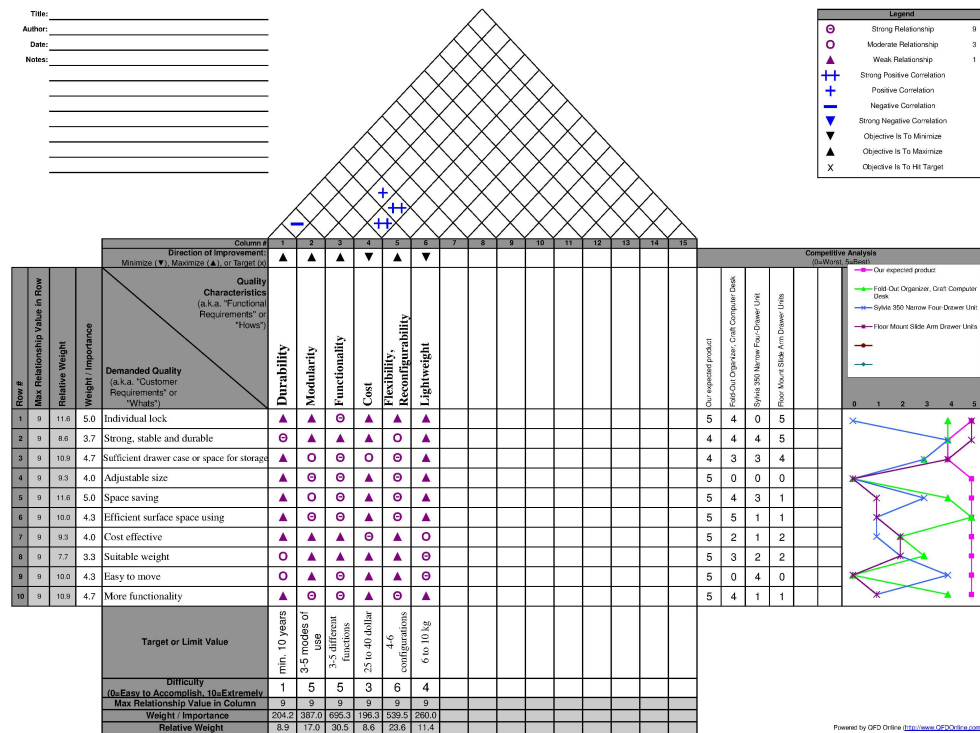

FIGURE 4.9: QFD table for the drawer unit

Valet stand:

I proposed couple of design specifications for the valet stand, which is mainly used by graduate students and academicians. The initial target or limit values for each specification are:

1. **Functionality:** Three different functions will be included for contraposing each demand quality;
2. **Modularity:** 2 to 3 attachable parts;
3. **Cost:** The target price would be between \$10 and 15;
4. **Reconfigurability:** 2 to 3 configurations;
5. **Weight:** As a single component of the final integrated product, the weight scale is expected and controlled between 4 kgf and 6 kgf;
6. **Compatible with other furniture items:** 2 to 3 different items.

The details are given in the Figure 4.10.

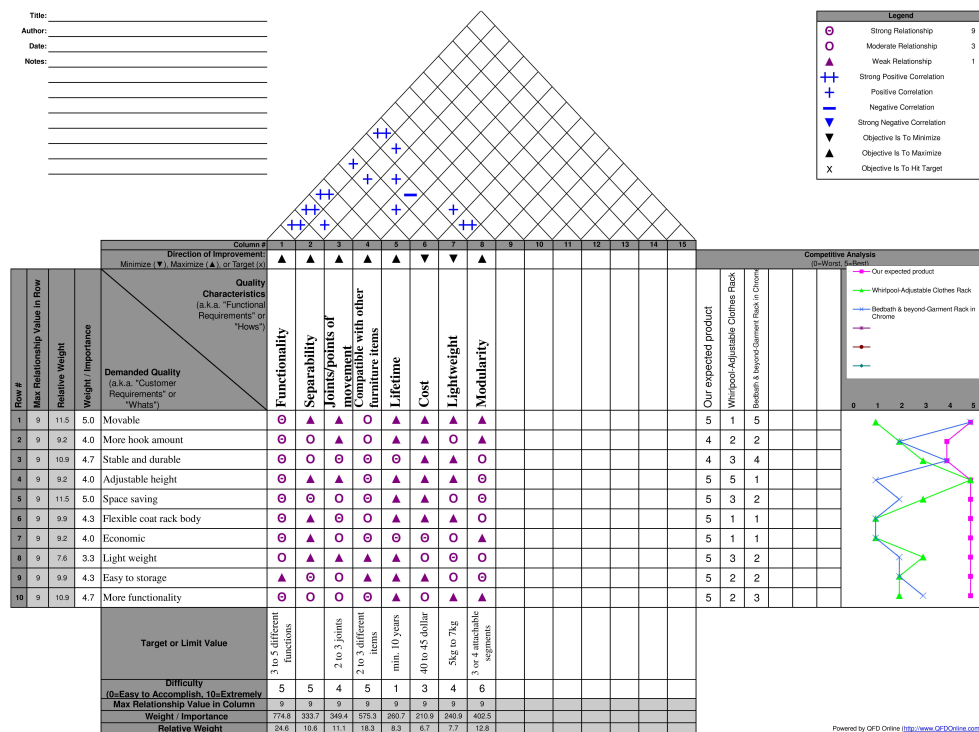

FIGURE 4.10: QFD table for the valet stand

Coat rack: The initial target or limit values for each specification in the coat rack are:

1. Functionality: 3-5 different functions will be included for contraposing each demand quality;
2. Joints/points of movement: 2 to 3 joints;
3. Cost: According to the customer’s expectation price and my prediction, the target price would be between \$40 and 45;
4. Modularity: 3 or 4 attachable segments;
5. Weight: As a single component of the final integrated product, the weight scale is expected and controlled between 5 kgf and 7 kgf;
6. Compatible with other furniture items: 2 to 3 different items.

The details are shown in the Figure 4.11.

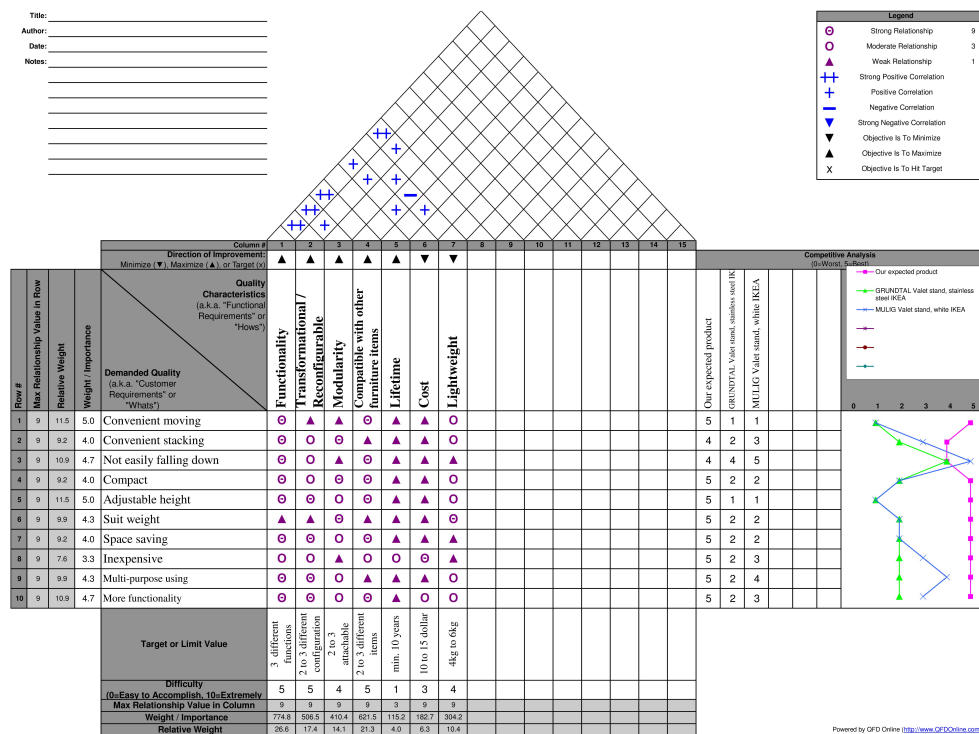

FIGURE 4.11: QFD table for the coat rack

Lamp: This is the most considerable item between undergraduate and graduate students. Based on the survey group needs, different design specifications have also been determined. The initial target or limit values of each specification are:

1. Functionality: 3-5 different functions will be included for contraposing each demand quality;
2. Flexibility: Flexible length up to 30 cm;
3. Cost: according to the customer’s expectation price and my prediction, the target price would be between \$10 and 20;
4. Modularity: 3 or 4 attachable segments;
5. Weight: As a single component of the final integrated product, the weight scale is expected and controlled between 3 kgf and 4 kgf;
6. Compatible with other furniture items: 2 different items.

The details are presented in Figure 4.12.

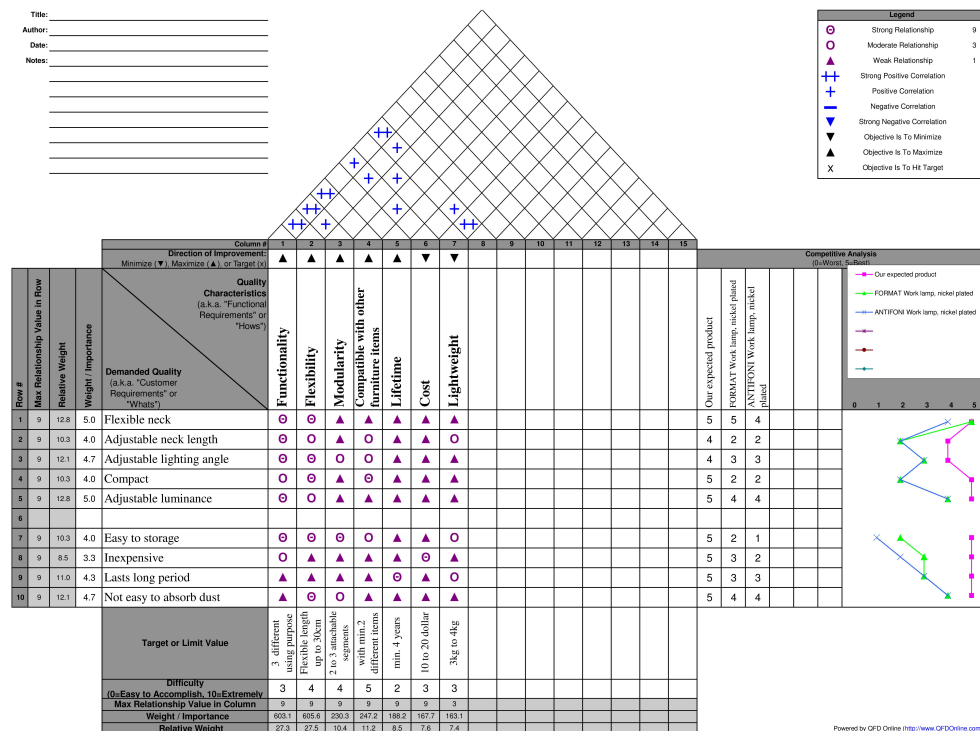

FIGURE 4.12: QFD table for the lamp

## 4.2 Analysis and examples of target product

After identifying and recognizing the existing problems and users’ needs, market analysis is also necessary for getting information about each targeted furniture item. In this section, I will present market survey results in terms of selected furniture prices, materials,

and various configurations. Moreover, information on state-of-the art products in market will be presented.

### 4.2.1 Market Analysis

As mentioned in the previous chapters, the core purpose of the product design is to meet market demands and satisfy customer needs for more convenience and productivity. Keeping these ideas in mind, I performed a market research for comparing different types and prices of some selected furniture items to determine the cost scale for the proposed product (i.e., whether these new features will bring great cost benefits and high level functionality).

First, I started my research on different types of coat racks at furniture markets and the general research results are presented in Table 4.5. Standard type coat rack made by timber, metal and medium size model shown in figure 4.13, 4.14 and 4.15 respectively. Then, I also conducted a survey on different types of valet stands. I found (some furniture stores in Istanbul)\* that the main material used on valet stand is timber. The valet stands have several model types that are primarily based on their sizes and rails. Table 4.6 presents the types and their corresponding prices.

I have also visited some famous accessory supplying vendors, such as IKEA, and conducted a survey on various types of lamps used for working, reading, and bed stand according to their different structural features. Table 4.7 shows the survey results for several types of lamps from the IKEA store.

\* These investigation results are obtained from some famous furniture stores in Istanbul like İstikbal, Doğutaş mobilya, Yay mobilya etc.

TABLE 4.5: Research results on several types of coat rack with their prices

Coat Rack	Type	Material	Price (TL)
1	Standard type (190cm)	Timber	150-170
2	Special type with rotational bottom hanger (190 cm)	Timber	220-250
3	Standard type (190 cm)	Metal	200
4	Special type with rotational bottom hanger (190 cm)	Metal	230
5	Medium size mode (110 cm)	Timber	145



FIGURE 4.13: Standard type coat rack made of timber



FIGURE 4.14: Standard type (190 cm) coat rack made of metal



FIGURE 4.15: Medium size model coat rack made of timber (110 cm)

TABLE 4.6: Research results on several types of valet stand with their general prices

<b>Clothes Valet Stand</b>	<b>Type</b>	<b>Price (TL)</b>
1	Clothes valet stand with single rail (wooden, 118 cm)	115
2	Dual Rail Clothes valet stand (wooden, 118 cm)	120
3	Double Hanger mute butler (wooden, 118 cm)	125



TABLE 4.7: Research results on several types of lamps with their general prices

<b>Lamp</b>	<b>Type</b>	<b>General price (TL)</b>
1	Nickel-plated, Bed Lamp	60
2	Adjustable neck,multipurpose lamp, (grand standing type, 135cm)	99
3	Desk table lamp with adjustable,neck	125

#### 4.2.2 New Product Information in current market

After generally looking into the market prices for several types and models of our proposed furniture, I conducted a search on online stores to see recently designed furniture (valet stand, clothes rack, desk with drawer). During my search, I have focused on to what degree these new models have addressed the problems presented in preceding sections. 1. On the Houzz (online furniture market), I came across a product and its design style is closely related to my initial design ideas. It is a fold-out organizer and craft computer desk with the reasonable price of \$138.88 (Figure 4.16). This folding organizer desk gives customer a big space saving opportunity. With the leaf on each side folded down, this desk can be used as a common end table; and when it is folded up, the leaves perform as a file cabinet. The three small drawers on the main body make room for keeping frequently used common items, and a lower letter file is perfect for storing bills and paperwork. This implemented design method on this product is mainly focused on efficaciously using of space and adding functionality on a single product. Consequently, the product is providing great benefits to customers.



FIGURE 4.16: Fold-Out Organizer and Craft Computer Desk [56]

2. On the same website, I also found a special valet stand - nightstand valet stand, selling with a price of \$92 (Figure 4.17). This artfully designed white color valet stand effectively uses the side spaces and combines with the partial concept of typical nightstand. It has a drawer and two shelves that can be used as a night stand by the bed or used as a storage and organizer for a room. At the same time, it can function as a normal valet stand by keeping jackets and/or upper outer garments at the hanger placed at the back side of the product body. This product also greatly provides space and cost saving to customers.



FIGURE 4.17: Nightstand Valet Stand [57]

3. Different models of portable and adjustable cloth racks have been designed and are on the market as well. These design concepts to some degree solved the similar problems that exist on coat rack listed earlier. However, there are still some differences between uses and purposes of coat rack and cloth rack. At Whirlpool (furniture website), they supply a new type of cloth rack - Adjustable Cloth Rack (Figure 4.18). The adjustable hangers allow one to conveniently hang garments straight from the washer or dryer and it is collapsible and removable for quick and easy storage. The rotating arms pivot independently to accommodate various configurations to enable possibility of hanging much more clothes.

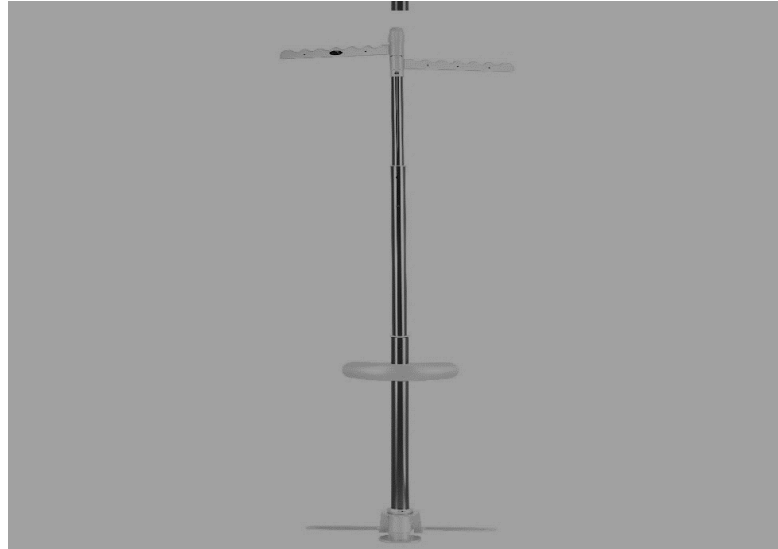

FIGURE 4.18: Adjustable Clothes Rack

At Bed, bath & beyond, there is another new type of garment rack - Garment Rack in Chrome (Figure 4.19). This garment rack is easy to move and carry with smooth rolling swivel casters. This new design has added new ability, portability, to typical garment racks. It has solved the problem that was raised here; and it gives customers more convenience than the previous types.



FIGURE 4.19: Garment Rack in Chrome [58]

Through this research, general market information including the prices, various models and types, and materials of different commodities have been discussed. This information will be utilized in overall design process for the new product development (coat rack, drawer unit, valet stand, and lamp).

### 4.3 Summary

In this section, I have conducted a series of analysis on target products. Based on this information, I built my design specifications on each object by QFD analysis. Furthermore, I have collected various information about our target products on current furniture market. In next chapter I will present the initial design ideas for each unit of targeted products, which have quite useful and practical applications for office workers and students. Moreover, each part of the products (light-stand, drawer, coat rack, and lamp) will represent corresponding design methodologies including transformational design principles, reconfigurability, and flexibility. Furthermore, I generate design concepts for products, which are generated by the combination of new ideas with different options, their improvements, constraints, and corresponding design tools. These final products will be targeted for offices and student housing/dormitories, in which space is tight, budget is limited, frequent moving is necessary and multi-functionality is needed.

## Chapter 5

# Conceptual Design for Integrated Product

### 5.1 Initial Concept Design Ideas for Each Unit

#### 5.1.1 Drawer Units

As a main body of the targeted product, it was intentionally placed at the bottom. It is the best and necessary option to setting it in a central position for holding and carrying the parts. Now, the properties and corresponding problem-solutions will be described as follows:

Mobility: The bottom part of the drawer will be assembled on rotatable swivel casters for easily carrying and rotating. I have come up with two options: corner-placed casters and center-placed caster units, as shown in Figure 5.1. From these two, I have chosen the center-placed caster, since I can add foldable stand legs at each corner. These legs can be in stand position, when the expected product is in motion. The legs can be folded down, when product needs to be stabilized. Thus, transformational design method has been used with this initial idea, which satisfies both mobility and stability in one product body.

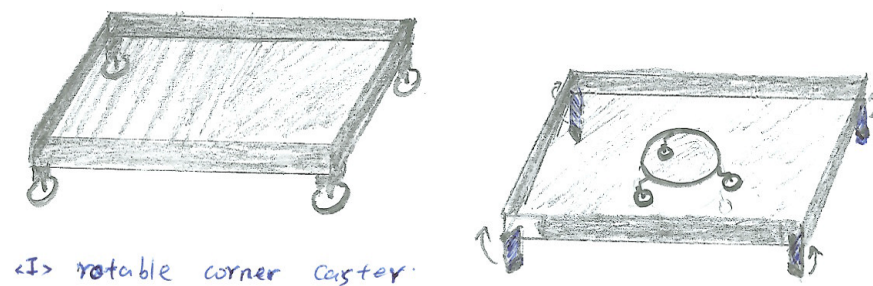

FIGURE 5.1: Hand draft of the two types caster models

Separability: Typically drawer units consist of three or four drawers and each drawer is installed in the main body and cannot be removed (cannot be separated from the body). For this case, I considered modularity of the drawer unit. The intermediate parts, which are in between the top and base drawer (which has central caster at the bottom of it), can be designed as independent drawer cases, whenever the unit needs more drawer cases, the independent part can be embedded by inserting block(s) on the top and base. At the point where the block is located, there are two options as well: i) one block on each corner of the free part (four blocks) and one hole on each corner (four holes) for the basic part; and ii) one block at the center of free part, and one hole on the center of basic part (Figure 5.2). Since I am targeting a more flexible product, I have selected the second option. The embedded section can be rotated and the opening direction of the drawer can easily be set by user's preference. With this modification, I can reach a changeable size and alterable weight for the product. These provide space saving, ease of carrying, and multi-directional use.

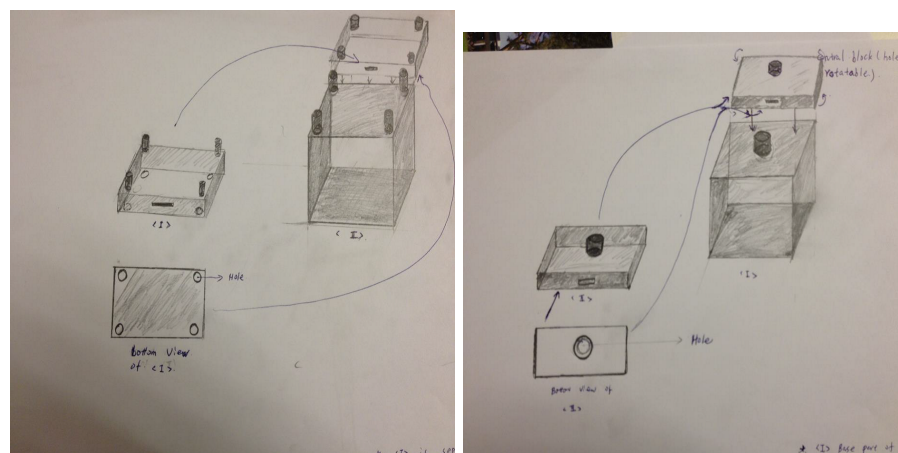

FIGURE 5.2: Hand drafts of two types of separability options

Movability of drawer interfaces: As mentioned above, in normal drawer unit, drawers are installed in a cabinet body, therefore, there is no special interaction between

drawers with their interfaces. At this point, by connecting the independent drawer cases with an extension rail, each drawer can be extended or moved up to certain length on its interface with adjacent drawer. This can improve the surface usability. Here, I have two options as well: i) extension along x- direction; and ii) extension along y-direction (Figure 5.3). Both options can be acceptable as initial innovative ideas. The extension can be performed on double sides (drawer can be moved to both right side and left side individually). This idea represents expend/collapse principle of transformational design, and provides much more space for users, when each drawer case is extended from its initial position (either on x- or y-direction).

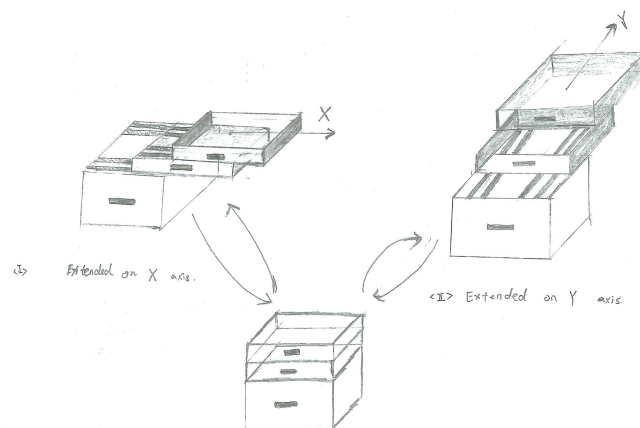

FIGURE 5.3: Hand draft of movable drawers along x and y axes

Side Foldable Pocket: I come up with an additional enhancement for efficient space usage. On each side of the drawer (except the front side where the drawer is opened), I can set a smart cabinet for storing items with small dimensions. In this idea, I have used one of the transformational design facilitators: fold. Thus, I can improve the functionality of a single drawer case by enhancing storage capacity and efficiency through side space usage (Figure 5.4).

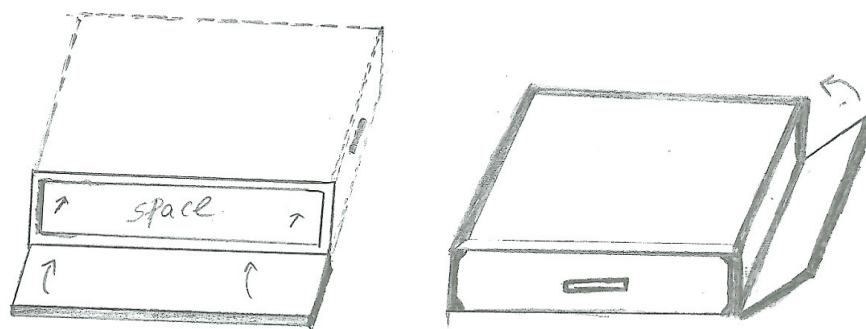

FIGURE 5.4: Hand draft of the foldable side pocket



Adjustable Stand Leg: When considering the mobility of the drawer unit, it was determined that the central caster unit is more suitable for our design. Moreover, I can add foldable standing legs such that the stable state and the movable state can be interchanged easily. I came up with a new idea for making improvements on the stand legs. If the length of the stand legs can be adjusted, the user can get more open space under the base drawer. Here, we have two options for carrying out adjustable length of standing legs:

1. Segmental leg connection: Making the standing legs segmentally so that each segment can be folded on their junctions. Users can adjust the length by unfolding the segments (Figure 5.5), when they need the drawer unit at stable state. The maximum length of a stand leg depends on the number of junctions. Here, I introduced the transformational design facilitator: segmentation.

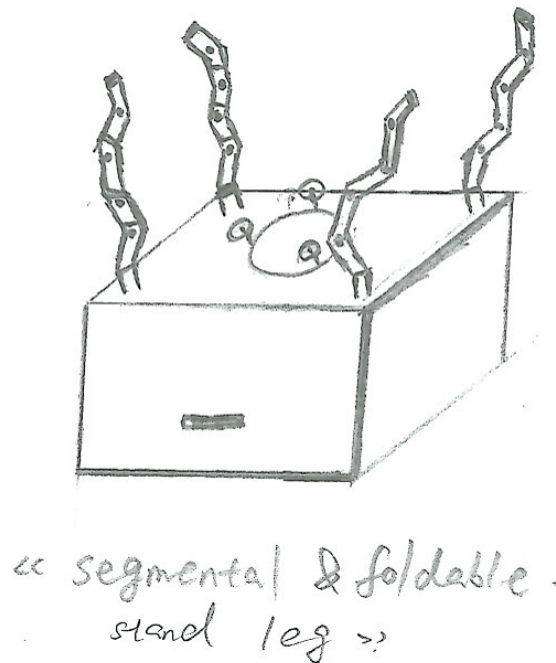

FIGURE 5.5: Hand draft of segmental and foldable standing legs (flipped)

2. Swallowed tapering legs are in telescope shape on each corner. The standing legs can be extended when user needs to stabilize the drawer unit; and it also creates empty space under the base drawer. When there is a need to turning it back to movable state, the extended standing legs can be enclosed in each other and converted back to the origin position (Figure 5.6).

TABLE 5.1: Drawer unit initial design ideas

Idea	Methodology	Advantages	Potential Disadvantages
Mobility	Transformational design principle & facilitator: expose/cover & Fold	Easy to carry, rotatable, selectable states (moving and stationary state)	Increase weight
Separability	Transformational design principle & facilitator: fuse/divide &Modularity	Adjustable size makes users feel more comfortable on space usage	Unsteadiness
Movability on drawer interfaces	Transformational design principle: Expand/Collapse	Give user effective surface usage	Balance consideration
Side Foldable Pocket	Transformational design principle & facilitator: expose/cover &Fold	Provide more cabinet for storing small size items	Construction difficulty
Adjustable stand leg	Transformational design principle & facilitator: expose/cover & Segmentation, Telescope	Provide adjustable height, enabling user to use bottom space	Intensity of pressure; material consideration; balance consideration

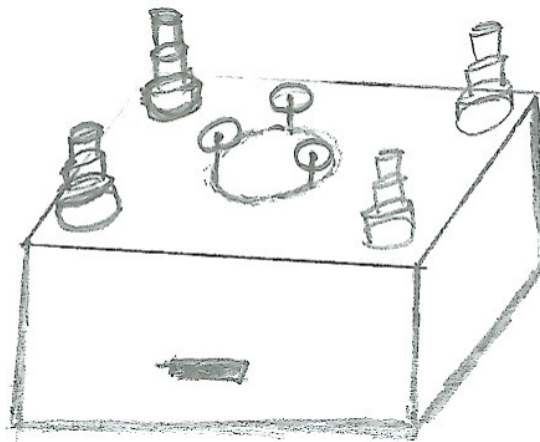

FIGURE 5.6: Hand draft of the telescope shape standing legs

The stated initial ideas for drawer unit and their corresponding advantages and potential shortcomings are summarized in Table 5.1.

Heretofore, I have represented couple of ideas and improvements by the implementation of certain design concepts in different aspects on drawer unit. Next section, we will put forward the ideas regarding the improvement and performance of a valet stand on a drawer unit body.

### 5.1.2 Valet Stand

As an additional function of our expected product, the base and central part of our product can be improved and functionalized as valet stand by implementing several new ideas as described below:

Hidden form as a valet stand: On the back side of base drawer, we set two vertical rails at each edge. On the top of the rail I embedded a head, which is similar to a typical top section of valet stand. The height can be adjusted by inserting the two brims into the two rails. The head part can be raised up to certain height (or maximum height) and can be fixed at that level to perform as a valet stand (Figure 5.7). Moreover, it can be hidden when it is not needed. This idea has implemented the transformational design facilitator-composite & telescope. This operation can provide users to use the space more efficiently with the benefit of multi-functionality.

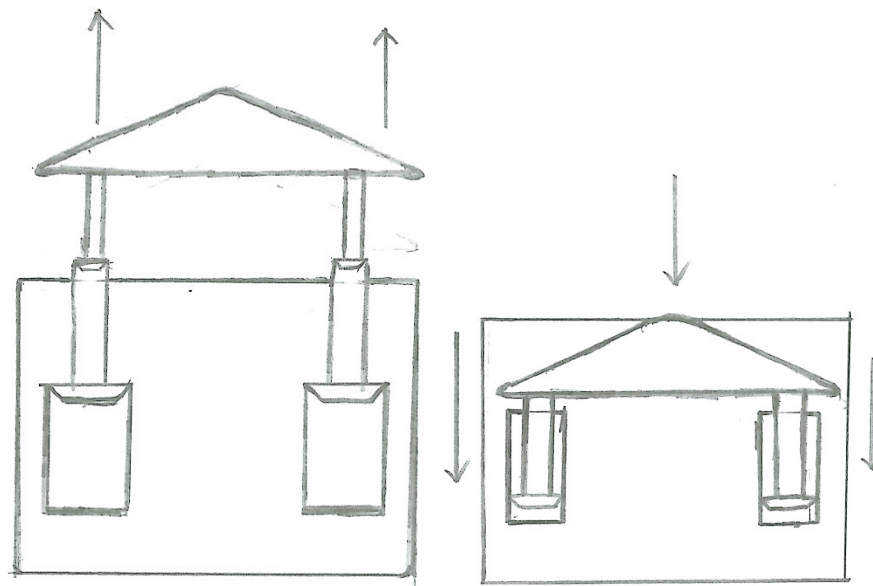

FIGURE 5.7: Two states (up-down) of hidden valet stand

Foldability & Adjustability: A valet stand can also be made foldable and adjustable. I set one horizontal rail on the backside of a base drawer, and add two adjustable height brims with horizontal folding valet stand head (Figure 5.8). When I

move the two brims to two sides on different directions, the head part, which is initially folded, would be opened. Finally, I can increase the height of two brims by raising them up so that it can be used as a valet stand. This idea is based on the transformational design facilitators including fold, segmentation, and fan.

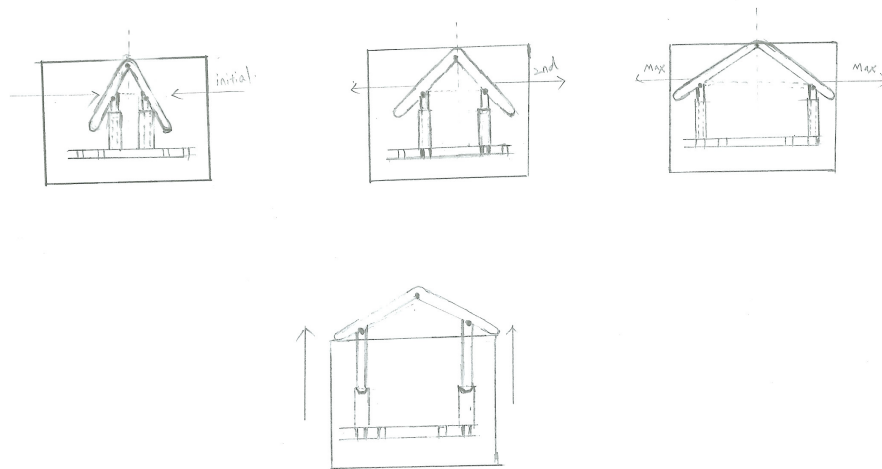

FIGURE 5.8: Foldable, movable, and adjustable valet stand form

**Reconfigurability:** According to the first idea, the embedded head can be functioned as an end table by its reconfiguration. When the head part is raised up to a certain height and then fixed, the head part can be folded down (from vertical state to horizontal state). Thus, it can serve as an end table (Figure 5.9). With this idea, the functionality of the hidden valet stand has been improved by adding reconfigurability. Additionally, space utilization has also been enhanced with adjustable height, foldable/collapsible section allowing users to be flexible about the features (valet stand/end table).

TABLE 5.2: Valet stand design ideas

Idea	Methodology	Advantage	Potential Disadvantage
Hidden form -valet stand	Transformational design principle & facilitator: expose/cover&, Composite, Telescope	Provide alternative selection for user, space saving, economical	Increase in weight
Foldability & Adjustability	Transformational design principle, facilitator: fuse/divide & Fold, Segmentation, Fan	More flexible, easy to store away, make product tidier	Material selection
Reconfigurability	Reconfigurable design method	Multifunctionality due to its reconfiguration	

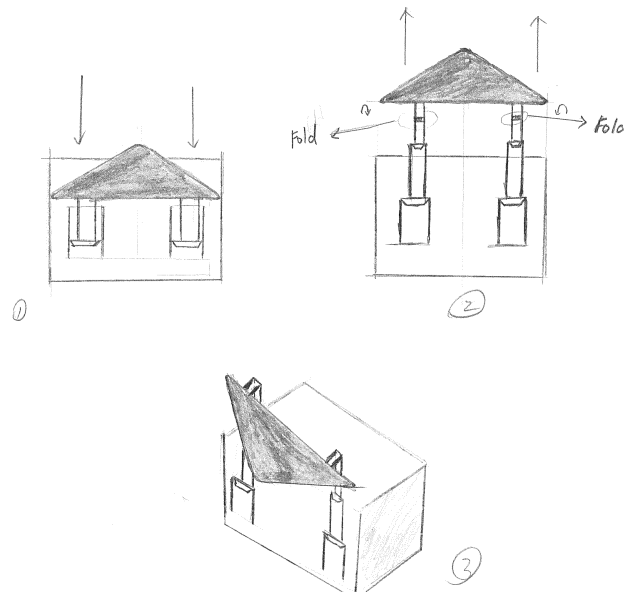

FIGURE 5.9: Reconfiguration of a valet stand to be used as an end table when needed

The stated initial ideas for a valet stand and their corresponding advantages and potential shortcomings are summarized in Table 5.2.

### 5.1.3 Coat Rack

As an additional function of our expected product, the base and central part of our product can be improved and functionalized to integrate a coat rack by implementing several new ideas as described below:

Removability: I come up with an ideal position for placing coat rack in the body-center of the drawer unit. I can install coat rack body by attaching to the top part of the drawer unit in center position. Thus, I can easily remove it from the drawer, when it is not needed or carry it to another place. With this approach, I considered modularity of the product and transformational design principle of fuse/divide (Figure 5.10).

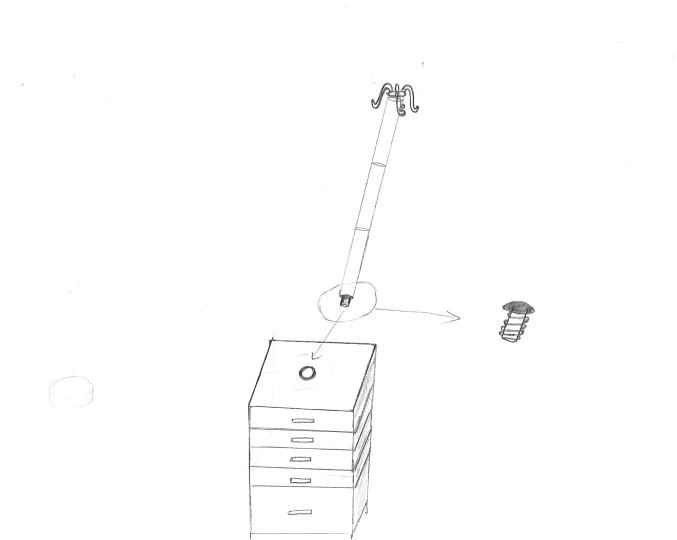

FIGURE 5.10: Removability of a coat rack

Adjustable Height: As mentioned in the problem statement section, most customers are considering the adjustability of a coat rack height to cope with different conditions and various ages. With these in mind, I figured out an adjustable coat rack body by implementing a transformational design concept. First, I considered the idea of controlling its height by combining several segments. I can increase the height by simply adding segments (Figure 5.11) through screwing (suggested). As a second option, I considered the coat rack body as a telescope shape. It can be fixed at its desired height level by raising each section (Figure 5.12). Here, the transformational design facilitators such as modularity, telescope and segmentation have been used.

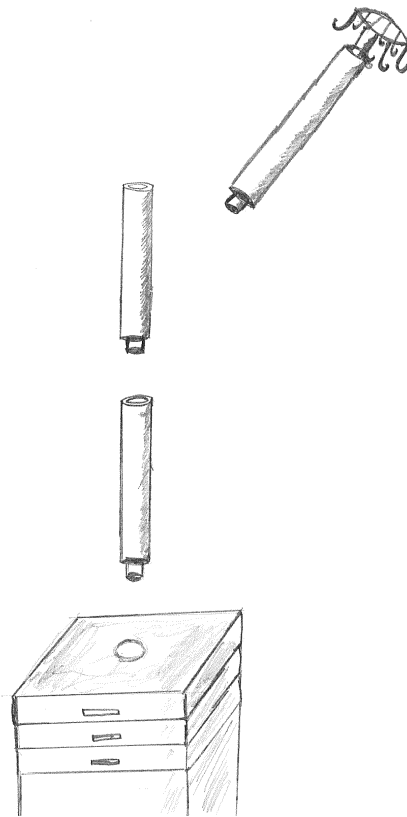

FIGURE 5.11: Adjustability of a coat rack body (segmental)

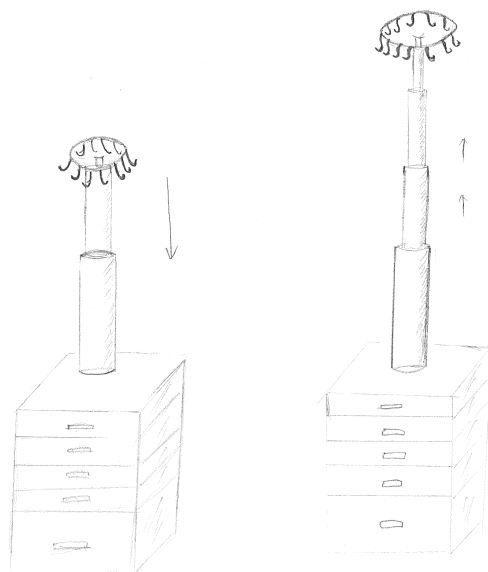

FIGURE 5.12: Adjustability of a coat rack body (telescope)

Adjustable hooks: The fixed hook on a coat rack is also problem for users based on my investigations. Therefore, I appropriated a couple of ideas for an adjustable hook. One of them is a movable hook. The thickness and durability can be increased

by attaching certain amount of moveable hooks for hanging up heavier items. Moreover, mixing and confusion during pick up can be prevented (Figure 5.13). Another idea is about the adjustability of a hanger's length (Figure 5.11). Each hanger can be pulled up to certain length so that one can elect the number of hooks by simply rotating and fixing it at that state. By this way, I can easily hang up items with its proper sized hook.

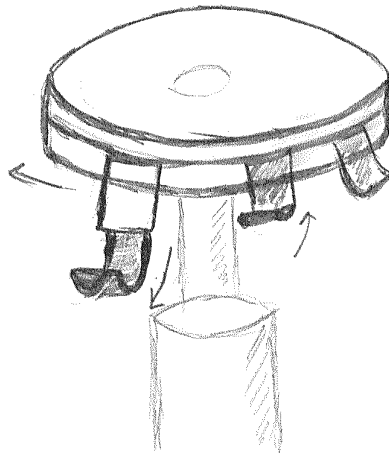

FIGURE 5.13: Adjustable and rotatable hook

Rotatable and Multi-Coat Rack body: This can be accomplished by connecting two or three parallel adjustable coat rack body with a rotatable base at the center of a drawer unit (Figure 5.14). Here, I used the flexible design method. Users can get much more convenience including easy to arrange hanging, more hanging area, and avoid mixing items.



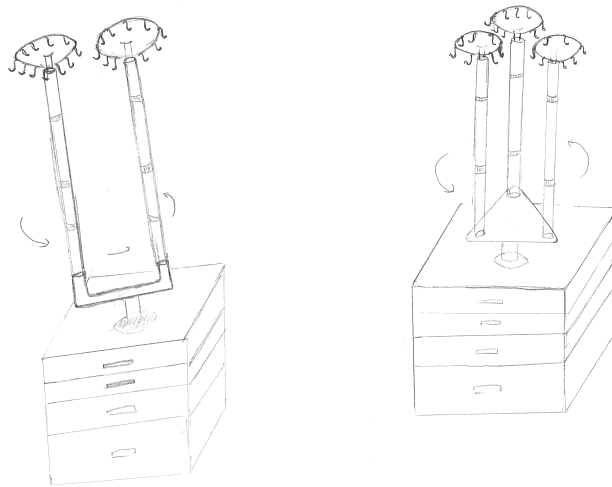

FIGURE 5.14: Rotatable multi-coat rack body

Flexible Coat Rack body: Based on the adjustable height idea, I can add couple of junction points between some segments. Thus, I can get foldability on a coat rack body as well (Figure 5.15). Users can benefit by multi-orientation when they need to keep their hanging coats away from them. This ability can also play major role in multifunctionality of a coat rack lamp, which I will present in next section. The transformational design facilitators such as fold, segmentation, and telescope have been used.

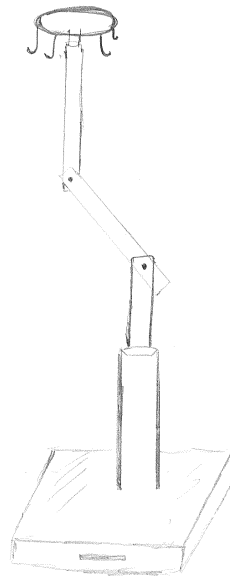

FIGURE 5.15: Flexible coat rack body

The stated initial ideas for a coat rack and their corresponding advantages and potential shortcomings are summarized in Table 5.3.

TABLE 5.3: Coat rack design ideas

Idea	Methodology	Advantage	Potential Disadvantage
Removability	Transformational design principle & facilitator: fuse/divide, expend/collapse & modularity, telescope and segmentation.	Provide alternative selection for user, space saving, economical	Instability
Adjustable height	Transformational design principle & facilitator: fuse/divide, expend/collapse & Modularity, Telescope	Users can reach different height levels according to their needs	Consideration for fixing problem
Adjustable hooks	Flexible design	Adjustable hook number, avoid the coats being mixed, provide multi option for hook number	Material selection
Rotatable Multi Coat Rack body	Flexible design	Easy to reach coat, multi amount coat rack body offers more available space for hanging coat	Increase in weight

### 5.1.4 Lamp

For generating the multi-purpose usage on a single product (bed lamp and/or desk lamp) and satisfying different customer needs, several different ideas are proposed:

i) Flexible neck lamp, ii) Adjustable length lamp neck, and iii) Adjustable light intensity.

i) Flexible Neck will increase the usefulness and lighting area of a lamp. Moreover, the lamp neck can be significantly compacted when it needs to be stored. Third, making the lamp body compatible with other items can enhance its functionality. For example, users can get rotatable and quickly useable lamp by placing it on the coat rack. Additionally, the movable drawer unit can provide higher positioning flexibility to the lamp.

ii) Adjustable length lamp neck is another option, which is mainly used in transformational design method. Users can get different state of lamp such as reading light, desk light, bed lamp, and general lamp for small room by controlling the length of a lamp neck (telescope shape or segmental body) and integrating with flexible coat rack body. The shortcomings of this idea include lack of stability of the lamp neck and increasing manufacturing complexity.

iii) Adjustable light intensity of a lamp is an important requirement for customers. In order to satisfy this need, a reconfigurable lamp cap added to the lamp. Users can cover the lamp by the cap when they need low intensity; and simply turn over the cap to have higher intensity. This reconfigurable lamp cap can be opened at different levels to obtain different luminance. However, this initial idea has some drawbacks like difficulty of fixing the cover at different levels.

Up to here, I have presented all initial concept design implementations for each target furniture item. Additionally, some advantages and potential drawbacks have also been discussed. Next section, I will present the combination of different design ideas from the alternatives that I have discussed, and their embodiment in one product.

## 5.2 Generating Product Alternatives (Integration of New Ideas and Prototyping)

After presenting all conceptual ideas for each target unit, I selected most feasible items and combined them into one integral body to generate integrated product alternatives. Depending on the objectives, integrated furniture product, that meets the needs of target

clients, is the final goal. Additionally, the factors such as weight, size, price, and manufacturing difficulty level have been considered for the selection of the design concepts and integration. Here, I will present couple of integrated product ideas, which are based on various transformational design principles and reconfigurable design methodology. The integrated product models have presented using "SOLIDWORKS" modeling.

First Product Idea:

The first integration has been formed as follows (see Figure 5.16):

- Drawer unit: seperability, mobility, and side pocket
- Coat rack: removability and modularity
- Valet stand: adjustability and seperability
- Lamp: flexible neck and reconfigurable lamp cover

For the integration step, we can utilize the most suitable property of each unit to reach the best product. For example, through integration with the drawer unit, the coat rack and valet stand can have movability feature, which was strongly required by the customers. Furthermore, weight and height can be controlled by the modularity of the drawer unit and coat rack body.



FIGURE 5.16: First product integration idea

Second Product Idea:

- Drawer unit: movable drawer case at the interface, mobility, and side pocket

- Coat rack: removability and modularity
- Valet stand: adjustability and seperability
- Lamp: flexible neck and reconfigurable lamp cover

For this integration, I have changed the style of drawer cases from seperability feature to the movable drawer case at the interface (along x-direction). The modular coat rack body is kept. Another component is installed on the back side of the base drawer and it functions as a valet stand with the ability of adjustable height and reconfigurable head part. Flexible neck and reconfigurable lamp cover from lamp ideas again appeared with this integration. Lastly, the central caster and foldable stand leg ideas for the drawer unit were selected to support the movability of the final product (see Figure 5.17).



FIGURE 5.17: Second product integration idea

#### Third Product Idea:

- Drawer unit: seperability, mobility
- Coat rack: removability and modularity
- Valet stand: adjustability and seperability
- Lamp: flexible neck and reconfigurable lamp cover

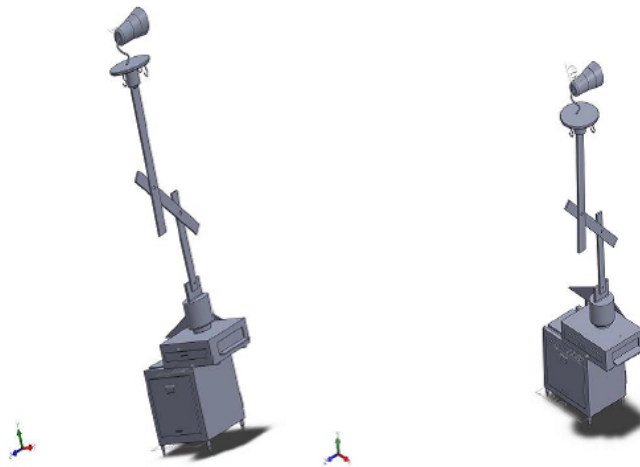

FIGURE 5.18: Third product integration idea

These integrated product ideas are generated by the selection of the most proper conceptual design ideas for each furniture item. The design factors such as weight, price, design complexity, and usability have also been considered for these selections. Nevertheless, these integrations still have some limitations for the real production. Therefore in the next chapter, I will validate these integration ideas, remove all unacceptable points and finalize our goal product.

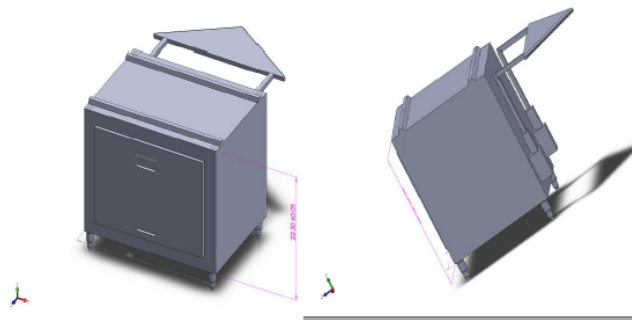

FIGURE 5.19: Reconfigurable valet stand

### 5.3 Analysis for Integrations (Materials, Cost, Dimension, Weight)

Having generated the conceptual integrations, feasibility and reliability of them will further be discussed. Feasibility and reliability of a desired product has an intimate relationship with accompanying factors such as material, weight, size, and cost. Therefore, I will present the materials used for each main section, sequentially discuss their weight,

cost estimations, and their final dimensions. Following that, I will compare these evaluations with my objectives and constraints (weight, size, and price). First integration model: We have basically three main selections as choice of materials: wood, metal, and plastics.

Initially, wooden material is selected for the coat rack segments (four segments with maximum 4x13cm height). For this selection, the total weight for the coat rack would be around 5 kgf. The raw material cost will be no more than \$25. As the base part of this integration, if the drawer unit is made from wood (three cases and one base cabinet), the total weight is about 8 kgf; and the material cost would be about \$35. Lastly, for the valet stand and lamp, if wooden material is used for their main parts, the flexibility of both units will diminish sharply. However, the wooden material is workable for the head part of the valet stand. The total weight and cost for these parts will be no more than 3 kgf and \$7, respectively. Total cost and the weight are \$67 and 17 kgf, respectively.

The second option is hard plastic material. The coat rack section's cost range would be around \$15, and the total weight will reach up to 3 kgf. If relatively hard plastic material is applied for the drawer unit's main body (outer coverage of the cabinets), the total weight will be around 5-6 kgf, and the cost range will be between \$20-30. However, this material will adversely affect the stability of the drawer unit cases and cabinet. Likewise, when valet stand is adjusted, it will have less stability as well. The weight would be about half of the wooden material, and also the material cost will be less than wooden material about \$5. The cost will be between \$2 and 3 for the lamp section. Total cost and the weight are \$53 and 11 kgf, respectively. Lastly, if metal (steel) is used, the total weight and cost of the product will be markedly increased compared to previous two material options. For the drawer unit, the weight and cost range will be around 15-17 kgf and \$35-45, respectively. For the coat rack, metal is also a big disadvantage for the product's stability and flexibility despite its enhanced durability. The total weight is at least 10 kgf and the cost is about \$25. Although this option has some disadvantages, light metal material for the valet stand is a good choice due to its good durability and robustness. However, the cost will be higher than the others (about \$10), and the weight is estimated to be 7-8 kgf. The main body of lamp (neck and lamp cap) will cost \$4. Total cost and the weight are \$84 and 36 kgf, respectively. The analysis is shown in Table 5.4.

Second integration model:

This model is very similar to the first model except two different functionalities (movability of the drawer unit cabinets on the interfaces and reconfigurability of the valet stand). Proposed materials are the same as the first model, but priority level of each

material is different. For the drawer unit, if the used material is metal or wood, this would offer higher stability and durability. Moreover, metal or wood option will offer accurate balance between the components in the case of motion. Reconfigurability, flexibility, and stability should be considered during its operation for the valet stand. Thus due to these requisite needs, wood and/or metal combination offers better option than single plastic material.

Third integration model:

The third integration model has some unique parts, which are very different from the others. The coat rack body is created by the segments, which are connected with three joints providing high flexibility and usability. Initially, wooden material is preferred for this part. The weight and cost will be 5 kgf (with 60cm height) and \$20, respectively. The drawer unit has separable and less number of drawers than the previous models (maximum 2 cabinets). Therefore, the weight and cost will be 7 kgf and \$30, respectively. Additionally, if metal material is applied into the coat rack body, dimension change and balance will be hardly controlled and kept. The weight would reach approximately 8 kgf, and the cost will reach to \$15. For the drawer unit, the weight and cost will be 10-13 kgf and \$30-40, respectively. Since the plastic material has very low feasibility for these two components, its choice is skipped. The material cost and weight estimations are the same as the first model for the valet stand and lamp. Total cost and the weight for wooden material are \$59 and 16 kgf, respectively. Total cost and the weight for steel are \$89 and 30 kgf, respectively. The analysis is shown in Table 5.5.



TABLE 5.4: Material selection analysis for the first integration mode

	Drawer unit	Valet stand	Coat rack	Lamp	Total Cost (\$) /TotalW (kgf)
Material					
<i>Metal</i>	15-17kgf; 35-45\$; Increase weight, stability	7-8kgf; 10\$; Increase durability, robustness	10kgf;25\$; Decrease stability and flexibility, enhance durability	1.5kgf; 4\$; Flexible, durable	84 (\$) / 36 kgf
<i>Wood</i>	8kgf; 35\$; Stable, flexible	3kgf;7\$; Lightweight, less flexibility, stable	5kgf; 25\$		67 (\$) / 17 kgf
<i>Plastic</i>	5-6kgf; 20-30\$; Portable, light weight, low cost	2kgf;5\$; Low weight, low cost	3kgf;15\$; Unstable, low cost, low weight	0.5kgf; 2-3\$	53 (\$) / 11 kgf

TABLE 5.5: Material selection analysis for the third integration mode

	Drawer unit	Valet stand	Coat Rack	Lamp	TotalCost (\$) /TotalW(kgf)
Material					
<i>Metal</i>	13-15kgf; 30-40\$; Increase weight, stability	7-8kgf; 10\$; Increase durability, robustness	8kgf; 15\$; Decrease stability, flexibility	1.5kgf; 4\$; Flexible, durable	89 (\$) / 30 kgf
<i>Wood</i>	5kgf; 20\$; Stable, flexible	3kgf; 7\$; Light weigh, less flexibility, stable	7kgf; 30\$	N/A; N/A	59 (\$) / 16 kg
<i>Plastic</i>	N/A	2kgf; 5\$; Low weight, cost	N/A; Unstable, low cost, low weigh	0.5 kgf; 2-3\$;	53 (\$) / 11 kgf

In this section, the overall analysis of material selections for the main parts of the product has been discussed. Cost range and weight for different material types have been presented. This analysis will be combined with the QFD analyses to select the final product. The target values in terms of cost and weight for each unit are presented below:

- For the drawer unit: \$25-40 and 6kgf-10kgf;
- For the valet stand: \$10-15 and 4-6kgf;
- For the coat rack: \$40-45 and 5kgf-7kgf;
- For the lamp: \$10-20 and 3kgf-4kgf.

Finally, material choices based on customer feedbacks, QFD constraints, and material selection analysis for each model are discussed below:

First integration model:

The drawer unit will be made out of wood due to its low cost and easy operation. Wooden material is the optimum selection for the coat rack body segments due to its easy manufacturing and availability. Plastic material is preferred for the valet stand and the lamp due to its high flexibility, low cost, and low weight.

Second integration model:

Material choices for this integration model are very similar to the first one except the valet stand, which will be manufactured from wooden and metal combination.

Third integration model:

Wooden material is selected for the coat rack in this model, since it offers high transformational ability, flexibility, and cost effectiveness. Wooden material is selected for the drawer unit, since metallic material weight is very high. The combination of plastic and wooden material is selected for the valet stand. After selecting the most suitable materials from these alternatives for each integration model, prototype generation will be carried out. These products will be presented to our target customers to get their feedback for the product evaluation stage.

## 5.4 Chapter Summary

In the first part of this chapter, a market analysis of the new products in terms of price and functionality is presented. Second, various conceptual design ideas for each furniture unit considering the needs and requirements from the survey results are presented.

Next, the integration of these design ideas into one single product is presented. Three conceptual integrated products have been generated and they have been modeled by SolidWorks. Finally, I discussed the material using for each main section, sequentially make an estimation for their weight, cost, and their effect. Following that, I compared these evaluations with my objectives and constraints. Out of these estimation results, priority level, and the target users' suggestions, decision for each model's material selection was made.

In the next chapter, I will validate the integrated product alternatives by showing the prototype models for the first and third integration, which display the main features of the product to our target customers. At the end, I will briefly discuss possible improvements and future development trends as the last section of my thesis.

## Chapter 6

# Results, Conclusion, and Summary

### 6.1 Prototyping, Testing, and Validation

Based on the conceptual ideas, I generated three different integration models, which were displayed in the previous chapter. In this chapter, I will proceed with the prototyping process with detailed measurements for each component. By observing the desired functions and actual operation, I will find out obvious and potential limitations. Meanwhile, according to the customer's feedback and suggestions, possible improvements will also be discussed.

#### 6.1.1 Prototype Models

Due to cost, similar functionalities were not double-prototyped. Additionally, the prototyped models are mainly used for observation, actual operation, and collecting customer comments. Therefore, I made first integration model (Figure 6.1) and third integration model (Figure 6.2). Below, I will give their detailed information, including measurement values, functionalities, and design method implementation.



FIGURE 6.1: First integration prototype



FIGURE 6.2: Second integration prototype

### **First model**

Under the help of carpenter, I have generated the first integration model. Since, in manufacturing process, many factors were affecting the similarity between SolidWork model and real product, in this case, a few changes were made. Total weight and height of this model are 9.4 kgf, 121.5 cm, respectively. Total space occupation is (Base drawer's height: 40 cm, drawer case height: 19\*2 cm, coat rack: 43.5 cm) 128790 cm<sup>3</sup>. In this model, we have realized some expected part-functions which have been proposed in conceptual design as below:

- Movable drawer case on X direction

- Detachable coat rack body
- Rotatable coat rack head
- Flexible lamp neck and detachable valet stand

Each section can be separated according to the user's need. In this prototype model, the main integration ideas are included. However, movability (casters) and the reconfigurability of valet stand were not implemented in both prototype models due to material cost, added weight, and difficulty of manufacturing. The overall measurement information, main design methods, properties and shortcomings are listed in Table 6.1.

TABLE 6.1: Overall information of the first prototype model

<i>Section</i>	<i>Function properties</i>	<i>Design methods</i>	<i>Potential and evident limitation</i>
Drawer case	Detachable, Movable on X axis, Adjustable case amount	Transformational, Reconfigurable design	Interface smooth level is not enough with wooden material
Coat rack	Detachable, Portable coat rack body segment, Rotatable, Adjustable height	Transformational design	Clamping force level among segments is not ideal; with the increasing amount of segment, instability level will be increased as well
Valet Stand	Detachable	Transformational design	Without adjustable height and less flexibility
Lamp	Flexible, Detachable lamp cap	Transformational, Flexible design	Length and flexibility of lamp neck is not enough; less functionality

### Second model

This prototype model is almost the same as my expectation (displayed in the previous chapter). Flexible and rotatable coat rack body is the most striking attribute of this model. These properties offer high usability and wide direction range to lamp. A detachable coat rack, valet stand, drawer case and flexible lamp neck are the same as in the first model. Total weight of this model is 7.7 kg. Total space occupation is 126670 cm<sup>3</sup>. After manufacturing these two models, it can be seen that some sections are exchangeable between models (e.g., the coat rack body can display its function on different product model). The general measurements of this model, main design methods, properties, and different limitations are listed in Table 6.2.

TABLE 6.2: Overall information of the second prototype model

<i>Section</i>	<i>Function properties</i>	<i>Design methods</i>	<i>Potential and evident limitation</i>
Drawer case	Detachable, Movable on X axis, Adjustable case amount	Transformational, Reconfigurable design	Interface smooth level is not enough with wooden material
Coat rack	Detachable, Portable coat rack body segment, Rotatable, Adjustable height	Transformational design	Low stability when it is rotated, falling down probability; stable coat rack head
Valet Stand	Detachable	Transformational design	Increase weigh of the product
Lamp	Flexible, Detachable lamp cap	Transformational, Flexible design	Instability of the lamp cap during mounting and dismounting

### 6.1.2 Testing and Validation

By observation and manual operation of the prototyped models, I presented overall functions, measurements, and general limitations. Next, I proceeded with testing and validation by conducting a short customer survey among a specific costumer group. Moreover, during the prototyping process, I received some valuable suggestions from the furniture carpenter for future improvements. The main feedback for each integration model and potential disadvantages are described below:

#### **First model**

a) The connection part of the coat rack and drawer case has weak clamping force. This force would decrease as the dismounting and rotating time increase.

Suggestion: the connection point can be set up with bolt screw mechanism with a relatively suitable depth. This idea will offer higher stability when the coat rack and drawer case are connecting. Same principle applies for the each coat rack body segment. As a result, we can also increase the lifetime of the product.

b) Wooden material provides less smooth level, which is the quite important factor for a drawer case movement. This would generate inconveniences to users when they want to utilize the extra space.

Suggestion- insert rail, which is made by metal (like a drawer rail), at interface. This will lead to the drawer cases to be drawn and pushed easily.

c) We can utilize lightweight metal made an adjustable height mechanism for valet stand. Since this function is hard to reach by using wooden material. So in this prototype model I realized the detachability of the valet stand section.

d) Some customer suggested that the lamp neck should be longer and more flexible. Since, the coat rack body cannot be folded or changed its direction for lighting different areas. Furthermore, lamp cap should be connected with lamp neck by screws. Plastic material should be used for lamp cap due to its low cost and ease of operation. For the movability of the product, central casters are necessary. Therefore, caster should be installed instead of stable feet. However, in this model, due to the material and labor cost, we did not present the casters in our product.

### **Second model**

a) Coat rack head cannot be rotated and detached. This would give customer less flexibility and inconvenience, especially when they need to move or pack the product.

Suggestion: Head part should have screwing mechanism for connecting it with the body part. Through this idea we can reach detachability. The turntable head part will depend on customer's need.

b) Frequent folding up and down the coat rack body could make the joint holders weak. This would decrease its functionality. Suggestions:

1. Using big and strong metal screw bolt with bigger screw hole instead of light and handy screw hole.

2. Inserting more connection joints on the coat rack body part with light and small screw bold. Through this, we can avoid the folding point concentrations just on two screws. Moreover, we can get more flexibility.

c) Linking the electric cable for lighting the lamp, and setting it without overlapping the coat rack body are another problem stated by informants. Since the coat rack body has a high flexibility in this model, unless the cable is inserted or arranged properly, it will not perform its functions as planned.

Suggestion from the carpenter: when we make the main body segments of coat rack, small holes should be made which are crossed from bottom to top (head part). Additionally, electric cable must be a high flexible metal. We can insert and across it from that holes without affecting the main functions of whole product, connect it easily with lamp neck.



According to the various feedbacks and pointed limitations, I have comprehended the feasibility and manufacturability of the desired product. Some unreliable functions are removed and new ideas can be added on this integration, in addition I switched some idea from one to another, and figured out the most applicable integrated product for future work.

## 6.2 Summary and Recommended Future Work

Research in reconfigurable, transformational design methodologies hitherto have yielded significant contributions and valuable achievements in many domains. Moreover, these special design concepts bring valuable insights to engineers and help them to come up with many innovative product ideas. This will lead to generating more cost effective, highly usable, high performance products in many fields. Additionally, current innovators in furniture industry have also been using reconfigurable and transformational design guidelines to improve the functionality, usability, and novelty of future furniture products. Finally, multi-functional integrated products can provide more benefits to environment, economy, and society by using less materials, less cost and time. Therefore, these new design ideas and tools would provide better sustainability in manufacturing.

In this study, I have discussed the need for an integrated product and different cases have been demonstrated. I have conducted customer surveys from the potential target customers (university students, secretaries, and some academicians), and prepared QFD analyses. Based on these results, I came up with different conceptual design ideas under the guidelines of transformational design principles and facilitators, reconfigurable design, and flexible design concepts. As mentioned previously, two integration products have been generated, they all can meet the customer needs in some respects. Nevertheless, they still have some possibilities for improvement. Moreover, some product sections have not taken full advantage of design ideas. New ideas can be put in with transformational, reconfigurable design methods. Some products, which are more suitable for integration or combination, were not taken into consideration. Thereby, some limitations are proposed by the users as I presented in the previous section. Based on these studies, some future improvements and recommendations are presented below:

1. The movement of the drawer case can be improved. Only moving on x-direction may not be enough. Y-direction motion can be added. However, it is difficult to accomplish this in our models due to the valet stand.

2. The left and right side of the base drawer are not utilized due to weight and cost considerations. As a future improvement, a foldable newspaper holder, reconfigurable

chair for putting on shoes, detachable small shoes cabinet, and reconfigurable bag hanger (reconfigure between hanger state and computer power cord arranger) can be added.

3. Adjustable heights and movable chair mechanism can be inserted in central caster (for both models), which offers movability for our product. Thus, we can achieve both movability and height adjustability in one system.

4. Coat rack idea of the first integration model and flexibility of the second model can be combined in one product. Coat rack body segments will contain both screwing connection and flexible joint connection in one model.

5. Adjustable valet stand can be optimized with the involvement of spring and button. This mechanism is referenced from an umbrella. Users can rise up the valet stand simply by pressing a button, i.e. the spring pushes up the valet stand. Pressing down when it is not in use.

6. Lastly, usability tests can also be conducted to be able to achieve the best product for the customers. The usability tests can ensure that the final product would meet the customer requirements.

These are just a few innovative ideas towards further product improvement in the area of transformational and reconfigurable manufacturing. As research work and efforts continue, more novel ideas will be implemented in manufacturing.

# Appendix A

## Survey Questionnaire

### QUESTIONS:

1. What is your occupation?
  - a. Undergraduate Student. b. Graduate Student c. Office Worker d. Academician
2. Which furniture item of followings you are using in your dorm/house or your office?
  - a. Coat Rack b. Drawer c. Valet Stand d. Lamp (desk, bed, stand, or hanging lamp)
3. Are you facing problems when you use them?
  - a. Yes b. No
4. From which furniture item you are meeting problem (you can choose more than one)
  - a. Coat Rack b. Drawer Unit c. Valet Stand d. Desk/Bed/Stand/Hanging lamp
5. Do you have any problem out of their weight, height or convenience level?
  - a. Yes, I have b. No, I satisfied
6. Do you have any expectations for improvement from them?
  - a. Yes, I have b. No, that is enough for me
7. What is yours main needs or expectation form them?  
Coat Rack: Drawer Unit: Valet Stand: Desk/Bed/Stand/Hanging lamp:
8. Which price level do you prefer from each of them?  
Coat Rack: Drawer Unit: Valet Stand: Desk/Bed/Stand/Hanging lamp:

9. Which size (or dimension) scale are you expecting from each of them?

Coat Rack: Drawer Unit: Valet Stand: Desk/Bed/Stand/Hanging lamp:

10. Do you think the combination of these products (Coat Rack, Drawer Unit, Valet Stand, and Desk/Bed/Stand/Hanging lamp) will bring economic benefit for you?

a. Yes b. Not too much

11. Do you think integration of these products will bring you benefits for arranging the space of your working/living place?

a. Yes, It will b. No, I am satisfied

12. Will you prefer to purchase it (the new product by combination of them)?

a. Yes, I will b. No, I am satisfied

# Bibliography

- [1] Small biz connect. <http://toolkit.smallbiz.nsw.gov.au/part/14/69/291>, 2014. The Business Centre.
- [2] R.Nathan. Innovation and economic growth. 2004.
- [3] Forber. <http://www.forbes.com/innovative-companies/>, 2014. Statistics.
- [4] esp. meanings 1\_5 and 7\_8. Cambridge dictionary of american english.
- [5] Fourth edition of the american heritage dictionary of the english language. "american psychological association (apa): design". 2007.
- [6] S. Brinkkemper. "method engineering: engineering of information systems development methods and tools". *Information and Software Technology*, 38(4):275–280, 1996.
- [7] Robert, Q. <http://www.rqriley.com/pro-dev.htm>, 2014. Riley Enterprises, LLC. Product Design and Development Consultancy.
- [8] D. Wang, J.M. Weaver, R. Kuhr, R. Crawford, and K. Wood. Increasing innovation in multi-function systems: Evaluation and experimentation of two ideation methods for design. *Proceedings of the ASME 2009 International Design Engineering Technical Conferences & Computers and Information in Engineering Conference, San Diego, California, USA*, 2009.
- [9] H. Benjamin. Designing a flexible supply chain for new product launch. 2005.
- [10] F. Scott, A. Siddiqi, L. Kemper, and L. Oliver. Flexible and reconfigurable systems: Nomenclature and review. 2006.
- [11] Z. Liang. Functional morphing for manufacturing process design, evaluation and control. 2010.
- [12] J. Haldaman and Parkinson. Reconfigurable products and their means of reconfiguration. *ASME Design Engineering Technical Conferences DETC2010-28528*, 2010.

- [13] S. Skiles, V. Singh, J.E. Krager, C. Seepersad, K. L. Wood, and D. Jensen. Adapted concept generation and computational techniques for the application of a transformer design theory. *International Design Engineering Technical Conferences, Philadelphia*, 2006.
- [14] J. Byron and F. James. Process-oriented production planning and control: Factors that influence system design. *The Academy of Management Journal*, 31(1):123–153, 1988.
- [15] A. Ertas and J. Jones. The engineering design process. 2nd ed. 1996.
- [16] Course note. <http://www.me.unlv.edu/Undergraduate/coursenotes/meg497/ABETdefinition>, 2010. University of Nevada, Department of Mechanical Engineering, Las Vegas, USA.
- [17] K. Nitin, M. Vinay, and J. Kushal. Product detailing, a key to implementation of product design concepts for sustainable design. *ARPJN Journal of Engineering and Applied Sciences*, 9(4):441–442, 2014.
- [18] L. M. Ronald. [Design.ncsu.edu](http://Design.ncsu.edu), 2013. NC State University, College of Design.
- [19] B. Sheryl. Universal design of instruction. 2005.
- [20] M. Ronald, H. Graeme, and P. Jaine. Accessible environments: Toward universal design. 1991.
- [21] V. Gregg. Universal design of consumer products: Current industry practice and perceptions. *Ph.D., Director, Trace R&D Center, University of Wisconsin-Madison Jim Tobias, President, Inclusive Technologies, Matawan, New Jersey*, 2012.
- [22] Oxford american dictionary. 2005.
- [23] A.K. Sethi and S.P. Sethi. Flexibility in manufacturing, a survey. *International Journal of Flexible Manufacturing Systems*, 2(4):289–328, 1990.
- [24] J.H. Saleh, D.E. Hastings, and D.J. Newman. Flexibility in system design and implications for aerospace systems. *Acta Astronautica*, 53(12):927–944, 2003.
- [25] Y.P. Gupta and S. Goyal. Flexibility of manufacturing systems: Concepts and measurements. *European Journal of Operational Research*, 43(2):119–135, 1990.
- [26] A. Qureshi, J.T. Murphy, B. Kuchinsky, C. Seepersad, K. Wood, and D. Jensen. Principles of product flexibility. *ASME International Design Engineering Technical Conferences and Computers and Information in Engineering Conference, Philadelphia, PA.*, 2006.

- [27] E. Fricke and A.P. Schulz. Design for changeability (dfc): Principles to enable changes in systems throughout their entire lifecycle. *Systems Engineering*, 8(4): 342–359, 2005.
- [28] R. Palani, W.M. Van, M. Campbell, K. Otto, and K. Wood. Design for flexibility : Measures and guidelines. 2003.
- [29] P.K. Rajan, M.V. Wie, M.I. Campbell, K.L. Wood, and K.N. Otto. An empirical foundation for product flexibility. *Design Studies*, 26(4):405–438, 2005.
- [30] K.L. Wood and K.N. Otto. product design. In *Product Design*. Prentice Hall, 2001.
- [31] V. Singh, S.M. Skiles, J.E. Krager, K.L. Wood, D. Jensen, and A. Szmerekovsky. Innovations in design through transformation: A fundamental study of transformation principles. *International Design Engineering Technical Conferences, Philadelphia*, 2006.
- [32] M. Jason, K.L. Wood, and J. Dan. Transformation facilitators: A quantitative analysis of reconfigurable products and their characteristics. *Proceedings of the ASME 2008 International Design Engineering Technical Conferences & Computers and Information in Engineering Conference IDETC/CIE 2008 August 36, 2008, Brooklyn, New York, USA*, 2008.
- [33] S. Vikramjit, M. Stewart, E. Jarden, Krager, L. W. Kristin, J. Dan, and S. Robert. Innovations in design through transformation: A fundamental study of transformation principles. 2009.
- [34] J.S. Linsey, J. Laux, E.F. Clauss, K.L. Wood, and A.B. Markman. Effects of analogous product representation on design by analogy. 2007.
- [35] S.L. Julie. Design by analogy and representation in innovative engineering concept generation. 2007.
- [36] T.W. Mak and L.H. Shu\*. Use of biological phenomena in design by analogy. 2004.
- [37] E. Hacco and L.H. Shu\*. Biomimetic concept generation applied to design for remanufacture. 2002.
- [38] M.S. Rossitza and L. Nikolao. Reconfigurability and reconfigurable manufacturing systems state-of-the-art review. 2004.
- [39] G. Campbell. Fan. In *The Grave Encyclopedia of Decorative Arts*, 1(2):367, 2006.
- [40] M.G. Mehrabi, A.G. Ulsoy, and Y. Koren. Reconfigurable manufacturing systems: key to future manufacturing. *J Intell Manuf*, 4(11):403–419, 2000.

- [41] M. Kaighobadi and K. Venkatesh. Flexible manufacturing systems: an overview. *Int J Oper Manage*, 4(14):26–49, 1993.
- [42] K. Reuven. Design principles of reconfigurable machines. *Int J Adv Manuf Technol*, 2(34):430–439, 2007.
- [43] R.G. Landers, B.K. Min, and Y. Koren. Reconfigurable machine tools. *CIRP Annals-Manufacturing*, 1(50):261–274, 2001.
- [44] K. Yoram and S. Moshe. Design of reconfigurable manufacturing systems. 2011.
- [45] P. Spicer, Y. Koren, and M. Shpitalni. Design principles for machining system configurations. *CIRP Annals*, 1(51):276–280, 2002.
- [46] Y. Koren, A.G. Ulsoy, and Vision. principles and impact of reconfigurable manufacturing systems. *Powertrain International*, pages 14–21, 2002.
- [47] M. Satoshi, Y. Eiichi, K. Akiya, K. Haruhisa, T. Kohji, and K. Shigeru. M-tran: Self-reconfigurable modular robotic system. *iee/asme transactions of mechatronics*. 4(7):431–441, 2002.
- [48] Z.M. Bi, Y.T. Sherman, M. Verner, and P. Orban. Development of reconfigurable machines. *Int J Adv Manuf Technol*, pages 1227–1251, 2008.
- [49] K. Reuven, Y. John, and K. Yoram. Control of a non-orthogonal reconfigurable machine tool. *J. Dyn. Sys., Meas., Control*, 2(126), 2004.
- [50] S. Ferguson, K. Lewis, A. Siddiqi, and O.L. De Weck. Flexible and reconfigurable systems: Nomenclature and review. *ASME International Design Engineering Technical Conferences, IDETC2007-35745, Las Vegas, NV*, 2007.
- [51] A. Siddiqi and O. Weck. Reconfigurability in planetary surface vehicles. *Acta Astronautica*, 2008.
- [52] Compendex US Patent Search. <http://www.engineeringvillage.com/>, 2012.
- [53] L. Brian, C. Phil, and L. Kemper. Concept analysis for reconfigurable products. *Proceedings of the ASME 2012 International Design Engineering Technical Conferences & Computer Information in Engineering Conference IDETC/CIE 2012 August 12-15, 2012, Chicago, IL, USA,*, 2012.
- [54] A. Yoji. Development history of quality function deployment. 1994.
- [55] M.A. Chougule and S.P. Kallurkar. Integration of quality function deployment and value engineering in furniture manufacturing industry for improvement of computer work station. 2013.



[56] Houzz. <http://www.houzz.com/photos/3099803/>, 2014.

[57] Houzz. <http://www.houzz.com/photos/1091214>, 2014.

[58] Bedbathandbeyond. <http://www.bedbathandbeyond.com>, 2014. Garment Rack in Chrome.