

**T.C.  
ISTANBUL AYDIN UNIVERSITY  
INSTITUTE OF SCIENCE AND TECHNOLOGY**



**A MULTICRITERIA DECISION AID APPROACH FOR ENERGY  
PLANNING PROBLEMS: THE CASE OF RENEWABLE ENERGY OPTION  
IN SOMALIA.**

**THESIS**

**Mohamed Abdullah Mohamed**

**Department of Electrical & Electronic Engineering  
Electrical and Electronics Engineering Program**

**June, 2019**



**T.C.  
ISTANBUL AYDIN UNIVERSITY  
INSTITUTE OF SCIENCE AND TECHNOLOGY**



**A MULTICRITERIA DECISION AID APPROACH FOR ENERGY  
PLANNING PROBLEMS: THE CASE OF RENEWABLE ENERGY OPTION  
IN SOMALIA.**

**THESIS**

**Mohamed Abdullah Mohamed  
(Y1713.300020)**

**Department of Electrical & Electronic Engineering  
Electrical and Electronics Engineering Program**

**Thesis Advisor: Prof. Dr. Mehmet Emin TACER**

**June, 2019**



## ONAY FORMU

T.C.  
İSTANBUL AYDIN ÜNİVERSİTESİ  
FEN BİLİMLER ENSTİTÜSÜ MÜDÜRLÜĞÜ



### YÜKSEK LİSANS TEZ ONAY FORMU

Enstitümüz Elektrik-Elektronik Mühendisliği Anabilim Dalı Elektrik-Elektronik Mühendisliği (İngilizce) Tezli Yüksek Lisans Programı Y1612.040063 numaralı öğrencisi **Mohamed ABDULLAHI MOHAMED** 'in "Amulticriteria Decision Aıdapproach For Energy Planning Problems: The Case Of Renewable Energy Option In Somalia" adlı tez çalışması Enstitümüz Yönetim Kurulunun 19.09.2019 tarih ve 2019/19 sayılı kararıyla oluşturulan jüri tarafından oybirliği/oyçokluğu ile Tezli Yüksek Lisans tezi 08.10.2019 tarihinde kabul edilmiştir.

	<u>Unvan</u>	<u>Adı Soyadı</u>	<u>Üniversite</u>	<u>İmza</u>
<b>ASIL ÜYELER</b>				
<b>Danışman</b>	Prof. Dr.	Mehmet Emin TACER	İstanbul Aydın Üniversitesi	
<b>1. Üye</b>	Prof. Dr.	Murtaza FARSADI	İstanbul Aydın Üniversitesi	
<b>2. Üye</b>	Dr. Öğr. Üyesi	Gürkan SOYKAN	Bahçeşehir Üniversitesi	
<b>YEDEK ÜYELER</b>				
<b>1. Üye</b>	Prof. Dr.	Nedim TUTKUN	İstanbul Aydın Üniversitesi	
<b>2. Üye</b>	Dr. Öğr. Üyesi	Nezihe YILDIRAN	Bahçeşehir Üniversitesi	

ONAY

Prof. Dr. Ragıp Kutay KARACA  
Enstitü Müdürü



## **DECLARATION**

I hereby declare that all information in this thesis document has been obtained and presented in accordance with academic rules and ethical conduct. I also declare that, as required by these rules and conduct, I have fully cited and referenced all material and results, which are not original to this thesis.

**Mohamed Abdullahi**









*To my father and mother; To my brothers and sisters;  
To my roommates;*



## **FOREWORD**

I would like to express my gratitude to the people who, in a way or another, contributed to the completion of this work.

First of all, my special thanks go to Prof. Dr. M. EMINE TACER, lecturer at the ISTANBUL AYDIN UNIVERSITY for accepting to supervise this work in spite of his heavy schedule. His pieces of advice and suggestions have contributed a lot to the concretization of this study. His guidance and careful attention in reading and correcting this work helped in getting this study to its present form.

Second, my gratitude is addressed to all the lecturers of the ISTANBUL AYDIN UNIVERSITY especially those of the Institute of Applied Sciences, Electrical and Electronic Engineering Department, and to all the teachers who have been teaching me since primary school, for the intellectual and moral virtues they provided me with.

My sincere and deep gratitude go to all students with whom I studied together for the third level of university education in spite of the hard situation we faced.

Last but not least, I am really thankful to all those who contributed to make this work a success.

**April, 2019**

**Mohamed Abdullah Mohamed**

---



## TABLE OF CONTENT

	<u>Page</u>
<b>FOREWORD</b> .....	<b>ix</b>
<b>TABLE OF CONTENT</b> .....	<b>xi</b>
<b>ABBREVIATIONS</b> .....	<b>xiii</b>
<b>LIST OF FIGURES</b> .....	<b>xv</b>
<b>LIST OF TABLES</b> .....	<b>xvii</b>
<b>ABSTRACT</b> .....	<b>xix</b>
<b>ÖZET</b> .....	<b>xxi</b>
<b>1. INTRODUCTION</b> .....	<b>1</b>
1.1 Background .....	2
1.2 About Somalia.....	4
1.3 Socio-Economic Context.....	4
1.4 Quality of Life in Somalia.....	7
1.5 Electricity Supply in Somalia.....	7
1.6 Objectives Of The Study .....	8
1.7 Methodology .....	9
<b>2. ENERGY RESOURCES USED IN SOMALIA</b> .....	<b>11</b>
2.1 Forms of Energy used in Somalia. ....	11
2.2 Energy Consumption and Production .....	12
2.3 Transmission lines that is used in Somali power systems.....	16
2.4 How To Build Electric Power in Somalia.....	16
2.5 Decision makers and stakeholders in the local energy system.....	27
<b>3. OVERVIEW OF MULTI-CRITERIA DECISION-MAKING METHODS..</b>	<b>29</b>
3.1 Multi-Criteria Decision-Making Methods .....	31
3.1.1 Weighted sum method (WSM) .....	31
3.1.2 Scientific Hierarchy Process (AHP) .....	31
3.1.3 Preference ranking organization method for enrichment evaluation (PROMETHEE): .....	33
3.1.4 The Elimination and Choice Translating Reality (ELECTRE): .....	34
3.2 Renewable energy resources :Solar energy in Somalia .....	34
3.2.1 Brief History Of Photovoltaic Technic .....	34
3.2.2 Conversion Of Solar Energy Into Electrical Energy.....	34
3.2.3 How Solar Energy May Increase Access To Electricity In Somalia .....	35
3.2.4 Implementation Of The Solar Photovoltaic System In Somalia's Energy System .....	36
3.3 Sizing Of Photovoltaic System. ....	39
3.3.1 A Stand-Alone Photovoltaic System.....	40
3.3.2 The energy to be supplied to the inverter and its use.....	41
3.3.3 The energy to be supplied to the battery and its use .....	42
3.3.4 Statistical values of solar energy .....	43
3.3.5 Site specific characteristics .....	43
3.3.6 Principles of sizing and positioning of the solar panel .....	45

3.3.6.1 Role of the energy stock.....	47
3.3.6.2 The battery-appliances electrical connection .....	47
3.3.7 Method Of Designing And Sizing Large PV Plants .....	48
3.4 Application .....	50
3.4.1 Determination of the desired autonomy .....	50
3.4.2 Deduce the number of batteries.....	51
3.4.3 Calculating total Watt-hours per day needed from the PV modules.....	51
3.5 Transmission And Distribution Of Electrical Energy .....	53
<b>4. PROBLEM CLASSIFICATION .....</b>	<b>57</b>
4.1 Internal and External Uncertainties. ....	58
4.2 Shareholders Involvement. ....	59
4.3 Concentration of the Outside Environment.....	60
4.4 A framework for including MCDM and uncertainty in the decision making process .....	61
4.4.1 The basics of a new decision support tool.....	61
4.5 4.5Dominating Approaches. ....	63
4.6 Selecting suitable renewable energy in Somalia using Promethee method. ..	64
4.6.1 Steps of the PROMETHEE method .....	65
4.6.2 Numerical Application .....	67
4.6.3 pairwise comapison matrix.....	68
4.6.4 normalized pairwise comparison matrix .....	69
<b>5. CONCLUSION.....</b>	<b>77</b>
<b>6. RECOMMENDATIONS.....</b>	<b>81</b>
<b>REFERENCES.....</b>	<b>85</b>
<b>RESUME.....</b>	<b>89</b>

## **ABBREVIATIONS**

<b>AHP</b>	:Analytic hierarchy process
<b>ANP</b>	:Analytic Network Process
<b>DSS</b>	:Decision support systems
<b>ELECTRE</b>	:Elimination and Choice Expressing Reality
<b>GDP</b>	:Gross Domestic Product
<b>LSC</b>	:Large-Scale Consumers
<b>MAUT</b>	:Multi-Attribute Utility Theory
<b>MCDA</b>	:Multi-Criteria Decision Analysis
<b>MCDM</b>	:Multi-criteria decision making
<b>MODM</b>	:Multi-objective decision-making
<b>MSW</b>	:Municipal Solid Waste
<b>PROMETHEE</b>	:Preference Ranking Organization Method for Enrichment Evaluations
<b>WSM</b>	:Weighted Sum Method





## LIST OF FIGURES

	<u>Page</u>
<b>Figure 1.1:</b> The price of electricity and per capita GDP in east africa including somalia .....	8
<b>Figure 2.1:</b> Solar energy potential in somalia .....	18
<b>Figure 2.2:</b> Biomass and bioenergy flow chart .....	19
<b>Figure 2.3:</b> Wind energy potential in africa .....	23
<b>Figure 2.4:</b> A local energy distribution system. ....	26
<b>Figure 3.1:</b> Multi-criteria decision process .....	30
<b>Figure 3.2:</b> Basic diagram for photovoltaic installation.....	34
<b>Figure 3.3:</b> Example of solar inverter diagram .....	41
<b>Figure 3.4:</b> Block diagram of the large PV plant [31]. ....	53
<b>Figure 3.5:</b> Schematic diagram of the electricity production and transmission network Grid. ....	55
<b>Figure 4.1:</b> Common place various leveled structure of criteria utilized in vitality arranging.....	58
<b>Figure 4.2:</b> Framework for including multiple criteria and risk into the decision process.....	61
<b>Figure 4.3:</b> Example of a simplified local energy system model.....	62
<b>Figure 4.4:</b> Renewable energy ranking in Somalia.....	75



## LIST OF TABLES

	<u>Page</u>
<b>Table 2.1:</b> Installed Generators and Capacities from IPPs.....	14
<b>Table 2.2:</b> Average daily electricity consumption of a household in Somalia.....	15
<b>Table 3.1:</b> Estimated Daily Electrical Load Table for a Single Modern Household and a Modern Village.....	37
<b>Table3.2:</b> Recapitulative table of estimated daily electricity consumption for all categories of subscribers of the Somalia energy system horizon 2023, 2032, 2041 (in GWh) .....	38
<b>Table 3.3:</b> The corresponding system voltages at each peak power interval.....	47
<b>Table 4.2:</b> five point linkert scale and its description .....	66
<b>Table 4.3:</b> Alternatives and criteria .....	67
<b>Table 4.4:</b> five point linkert scale and its description. ....	68
<b>Table 4.5:</b> Calculating the sum of the matrix table .....	68
<b>Table 4.6:</b> Normazhed Matrix.....	68
<b>Table 4.7:</b> Normalizing value table .....	69
<b>Table 4.6.</b> Normalizing.....	69
<b>Table 4.8:</b> Normalizing value table .....	69
<b>Table 4.9:</b> Normalized values.....	70
<b>Table 4.10:</b> Deviation by pairwise comparison.....	70
<b>Table 4.11:</b> Calculate the preference function .....	71
<b>Table 4.12:</b> Calculate the aggregated preference function.....	71
<b>Table 4.13:</b> Aggregated preference function table .....	72
<b>Table 4.14:</b> Leaving and entering outranking flows .....	74
<b>Table 4.15:</b> Net Outranking Flow .....	74



# **A MULTICRITERIA DECISION AID APPROACH FOR ENERGY PLANNING PROBLEMS: THE CASE OF RENEWABLE ENERGY OPTION IN SOMALIA.**

## **ABSTRACT**

The growing environmental awareness and the apparent conflict between economic and environmental objectives was the main impetus that pushed energy planners during the early eighties towards the use of MCDA methods. Multi-Criteria Decision Making (MCDM) techniques are gaining popularity in sustainable energy management. The techniques provide solutions to the problems involving conflicting and multiple objectives. The rapid changes and the increasing complexity of the energy market gave rise to further methodological developments. Although the energy market restructuring and ongoing liberalization seemed to restrict the purpose for centralized energy decisions, they added new dimensions in energy planning. Increasing competition along with the prerequisite for sustainability have broadened the energy application field by bringing out new challenges for the development of integrated multi criteria and multi-stakeholders approaches also taking uncertainty into consideration.

This paper aimed at illustrating the evolution of MCDA approaches, in the context of the emerging problems faced by energy planners and other stakeholders involved in energy-related decision situations, one of the most active and exciting areas of application of MCDA models and methods. Several methods based on weighted averages, priority setting, outranking, and their combinations are employed for energy planning decisions. A review of more than 90 published papers is presented here to analyze the applicability of various methods discussed. A classification on application areas and the year of application is presented to highlight the trends. It is observed that Analytical Hierarchy Process is the most popular technique followed by outranking techniques PROMETHEE and ELECTRE. In this study we will apply promethee method to calculate the highest and lowest renewable energy ranking in somalia by considering four main renewable energy present in somalia according to four criteria we will select best suitable and sustainable renewable energy source in somalia.

**Keywords:** *Solar energy, wind energy, energy power, power plant, renewable energy, energy supply, energy deficiency,*



# ENERJİ PLANLAMA SORUNLARI İÇİN BİR ÇOK KRİTERLİ KARAR YARDIMI YAKLAŞIMI: SOMALİSTAN'DA YENİLENEBİLİR ENERJİ SEÇENEĞİ

## ÖZET

Artan çevre bilinci ve ekonomik ve çevresel hedefler arasındaki bariz çatışma, seksenlerin başında MCDA yöntemlerinin kullanımına doğru enerji planlamacılarını iten temel itici güçtü.

Çok Kriterli Karar Verme (MCDM) teknikleri, sürdürülebilir enerji yönetiminde popülerlik kazanıyor. Teknikler, birbiriyle çelişen ve çok sayıda hedefi içeren sorunlara çözümler sunar. Enerji piyasasının yeniden yapılandırılması ve süregelen liberalleşmenin, merkezi enerji kararlarının amacını kısıtladığı görülmesine rağmen, enerji planlamasında yeni boyutlar eklediler. Sürdürülebilirliğin ön şartı ile birlikte rekabetin artması, enerji uygulama alanını, bütünlük çok kriterler ve çok paydaşlı yaklaşımların geliştirilmesinde belirsizliği de dikkate alarak yeni zorluklar ortaya çıkararak genişletmiştir.

Bu makale, MCDA yaklaşımlarının evrimini göstermeyi amaçlamıştır, enerji planlayıcıları ve enerji ile ilgili karar durumlarında yer alan diğer paydaşların karşılaştığı sorunlar bağlamında, MCDA modellerinin ve yöntemlerinin en aktif ve heyecan verici uygulama alanlarından biri. Ağırlıklı ortalamalar, öncelik belirleme, dışa vurma ve bunların kombinasyonlarına dayanan çeşitli yöntemler enerji planlama kararları için kullanılır. Tartışılan çeşitli yöntemlerin uygulanabilirliğini analiz etmek için burada yayınlanan 90'dan fazla makalenin bir incelemesi sunulmaktadır. Trendleri vurgulamak için uygulama alanları ve başvuru yılı ile ilgili bir sınıflandırma sunulmaktadır. Analitik Hiyerarşi Sürecinin PROMETHEE ve ELECTRE'yi takip eden en popüler teknik olduğu görülmektedir. Bu çalışmada, Somali'deki mevcut dört ana yenilenebilir enerji dikkate alınarak, Somali'deki en iyi ve en düşük yenilenebilir enerji sıralamasını hesaplamak için Sometya'daki en uygun ve sürdürülebilir yenilenebilir enerji kaynağını seçeceğimiz promethee yöntemini uygulayacağız.

**Anahtar Kelimeler:** *Güneş enerjisi, rüzgar enerjisi, enerji gücü, enerji santrali, yenilenebilir enerji, enerji arzı, enerji eksikliği.*





## 1. INTRODUCTION

The role of electricity cannot be underestimated inside the monetary improvement of a country. The nonstop get right of section to power manages various favors to a country: transportation, home gear and light, appropriateness of indoor temperature, and wellness focuses. Business and business sports require a specific amount of power to highlight appropriately. More or less, undisruptive access to vitality (quality) makes presence deserving of dwelling to each individual [2].

Throughout the years, the call for electricity has improved in light of blast in people notwithstanding in business and human games, and in some topographical spots on account of atmosphere. Fossils fills represent about 80% of the all-out power innovation [2]. The innovation and utilization of fossil gas has raised extreme subject on the maintainable idea of fossil gas, also at the emanations which can be related with the admission of non-renewable energy sources. Meeting the quality essential of the individuals, supportability of intensity and normal affirmation are interconnected challenges that require pressing moves from each the creator of essentialness and its purchaser.

The bother of imperativeness undertaking may be said to mean get entry to efficient strength(power) supply, which has by no awful sway at the surroundings at big[3]. Much equivalent to most regions in the around the world, the country of Somalia is comparably gone facing with the mentioning conditions of essentialness security that requires the country to choose key choices to how best they can manage the power making courses of action issues. As it's miles nowadays, it is indisputably hard both to the specialists and to non-open associations to give an enough proportion of essentialness to meet the wants of the reliable creating people and tangled systems of living, and to diminish nursery fuel releases on the undefined time[4,5].

## 1.1 Background

Energy is fundamental to landing at the interrelated dreams of present day social requests: to fulfill demand of people for warming, freeze, brilliance establishments, convenience or walking a massive grouped assortment machines, despite to pass on power and warmth to age structures[41]. Until the erupt of the imperativeness crisis, assembling these needs changed into

a standard issue whose plan ended up being essentially a depend of money and advancement availability. At these events, concerning capita control confirmation changed into a secured record of a kingdom's prosperity, even as power making game plans changed into focusing on giving the quality needed at perfect moment and inside most economical approach [52]. The end of the 30 season have noticeable breakthrough in the overall's vitality arena as well as inside manner solidarity organizers. The guideline most important energetic occasion was the power emergency of the '70s. The sharp effect of solidarity costs revealed the greater part of the secured objectives behind the doltish viewpoint on adequate, increasingly reasonable and forsaken energy[4,5]. At almost the indistinguishable time, organic contemplations rejecting each of two the necessity for the usage of standard quality assets or the demand to address the technique with typical debasement, obliged a reexamination of attributes and a move nearer to another innovative blueprints. As a last thing, standard essentialness development, in spite of the way that regardless overpowering inside the power contraction, had been a growing number of challenged on environmental grounds. Cost, though regardless being the business focus' driving weight, changed into now lacking to reflect the overall population's multiple, unbalanced and much of the time conflicting concerns [4,5].

In this unique situation, control coordinators came all through extraordinary pickles that were not practical with traditional apparatus. They expected to watch a miles increasingly broad scope of decisions and break down the entirety of their more than one sides with recognize to a miles progressively broad extent of assessment standards underneath conditions of a predominant uncertainty[1,2].

Furthermore, they expected to recollect the unique, not completely verbalized choices of each focused on association of preoccupation. Normal request outlining their test on this new setting had been:

Which kind of intensity resource or change development to apply? How to merge indisputable power resources and advancement which will meet gift and destiny essentialness wishes?

Where to discover new quality transformation or transmission centers? The power zone has in this way been a productive floor for the advancement of a couple of bothers which are distinctively of a few criteria nature. Examiners and specialists have offered an explanation to the challenges with consistently growing bleeding edge issue definitions, styles and okay systems to address the arrangement of operational and masterminding issues developing in the essentialness region.

Additionally, Multi benchmark accord Analysis (MCDA) design and manner have discovered an astounding to promise productive decision of different burdens also to gave the basics to get the right choice[4,5]. In the past, the choice among elective essentialness rules at near to stage changed into set up together totally best regarding cost minimization. Recently, it is commonly perceived that near to imperativeness orchestrating structures a multi-performer and multicriteria bother. This is unequivocally confirmed by virtue of imperativeness age in domains offering superfluous costs of advancement in essentialness call for, together with a broad limit of feasible power source resources, seeing that not many and regularly conflicting points of view ought to be taken under consideration[1,2].

This paper utilizes a Many principle Choice Investigation method finish an assessment of distinctive period advancement that would be no ifs, ands or buts used for fulfilling the growing needs of the essentialness region on a very basic level reliant on specific checks which can be vital to recall while choosing force orchestrating decisions. Age from coal, flammable gas, nuclear power, hydropower, sun imperativeness (photovoltaics despite concentrating daylight based power), turn (inland and toward the ocean), geothermal power and biomass is in relationship. The criteria contemplated are-minimization of gadget

charges, water impression, carbon dioxide proportionate spreads, and land power of the picked power age [1,2].

## **1.2 About Somalia**

Somalia is situated in the Horn of Africa with a 2019 populace evaluated at 15.64 million, up from the 2013 gauge of 10 million[34]. The nation is quickly extending with nearly 3% yearly populace development and a high fruitfulness pace of 6.26 youngsters per lady, which is the fourth most elevated on the planet. Surface Area and Population Density of Somalia; This nation involves roughly 637,657 square kilometers of territory in Africa, on the Eastern coast which fringes the Indian Ocean and the Gulf of Aden. In blend with the all out populace, this gives us a general populace thickness of about 24 individuals for every square kilometer. There are two urban areas in Somalia with a populace more than 1 million: the capital, Mogadishu, is the biggest with 1.4 million and is intently trailed by Hargeisa at 1.2 million[40]. Socioeconomics of Somalia Around 85% of its kin are ethnic Somalis, who have occupied the district verifiably. Ethnic minorities make up the remainder of the populace and are moved principally in the southern zones of Somalia.

Non-Somali ethnic gatherings incorporate Benadiri, Bravanese, Bantus, Ethiopians, Indians, Persians and Italians. The Bantus are the biggest ethnic minority in Somalia and are plummeted from slaves brought by Arab brokers. After the nation picked up autonomy, most Europeans left the locale. The greater part of the individuals are Muslims, with the dominant part being Sunni. Its 10.9 million populace speaks to an enormous increment from the 3.3 million individuals in 1975, yet considerate struggle in the 90's expanded Somali diaspora and a significant number of the exceptionally taught individuals left[40].

## **1.3 Socio-Economic Context**

Until 1960, Somalia was under the English and an Italian protectorate. In 1886 the English landed at a protectorate simultaneousness with northern Somalia, while the Italian pushed toward getting to be protectorate with the eastern Somalia in 1889. Despite the fact that Somalia needs compelling national

administration on account of continuous brutality and political agitation, its generally casual economy can work through settlement/cash move organizations and broadcast communications. The focal government controls just piece of the nation, and formal financial movement is to a great extent limited to urban regions, for example, Mogadishu and a couple of local capitals[34, 40].

Security in Somalia is amazingly delicate in view of savage tribe based contentions inside the political world class and the proceeding with impact of Islamist agitators. The absence of focal specialist makes the standard of law conflicting and divided, with various local armies, experts, and clans applying shifting legitimate systems. Conventional Islamic statute (Sharia law) has turned out to be dug in [10]. Levels of debasement stay high, and the absence of straightforwardness and formal accounting makes government incomes powerless against misappropriation. Somalia's Gross domestic product and expectations for everyday comforts are among the universes most minimal; numerous individuals rely upon settlements from abroad. Domesticated animals, horticulture, and angling are financial pillars. The economy of Somalia bases on domesticated animals generation, which records for 40% of the nation's Gross domestic product. Media transmission and cash moves are other financial exercises in Somalia [10, 40]. In 2014, the Gross domestic product (obtaining power equality) of Somalia was evaluated to be \$4.431 billion. Power creation and utilization in Somalia was evaluated to be 315 million kWh and 293 million kWh (2012) separately.

Somalia is at an edge Rising up out of a winter of contention and unsteadiness, the nation is at a point where security and development will keep on flourishing given the correct help for financial recuperation and improved administration [10, 40]. To move Somalia past this edge, dynamically moderate and strong access to power is required. This report hopes to pull in keenness in regards to the worsening issues related with imperativeness in Somalia. The greater part of people living in natural and perurban districts have no passage to control. Those with access in urban territories are paying probably the most elevated levies on the planet for constrained and here and there problematic administrations. The weight of such mind-boggling expenses is borne by organizations, which must diminish their efficiency because of power costs and now and again consider

moving activities to different nations with increasingly reasonable power services[10, 40].

The strain of restricted and costly power is additionally felt by family units, wellbeing offices, and schools. A noteworthy loss of the issue is proceeded with deforestation as individuals keep on utilizing charcoal from Somalia woodlands for cooking needs[13,14,15]. No venture can pay social, natural, and monetary profits like upgrades in power administrations would in Somalia. As it has in different nations, progressively reasonable power would have a solid monetary multiplier impact, expanding rural and fabricating efficiency and making open doors for the rise of new organizations [11, 12]. Access to reasonable, solid power improves basic open administrations, for example, controlling wellbeing centers, clinics, and schools, and can expand family unit earnings by diminishing time and cash coordinated at securing cooking fills. It would likewise ease the devastating weight of charcoal utilization on natural assets in the nation.

Past the contention and shakiness that have stolen features in Somalia for quite a long time, tranquil, stalwart advancement driven by the private area has kept the nation above water. Presently, given the correct help, a flourishing business segment in Somalia is ready to help solidify political and financial stability[10, 40]. A hindrance to such advancement is the measure of moderate vitality to control it. With Somalia's devastated framework foundation from many years of contention and deterioration, their age of power is among the least productive and most exorbitant on the planet.

Somalia experiences three noteworthy issues identified with wide based jolt: absence of access, very surprising expenses, and low unwavering quality. Just a little minority of family units and organizations in the nation approach electricity[50, 51]. Dependable measurable data about the vitality circumstance all through Somalia is inaccessible as not many studies have been led in the nation over the most recent couple of years.

#### **1.4 Quality of Life in Somalia**

As of the 2018 World Satisfaction Report as introduced by Wikipedia demonstrates Somalia situating in at number 98 on the once-over of participating countries, with a general euphoria rating of 4.98 out of 10. Somalia has seen different issues over the latest couple of decades, including poor administration, extended inward clash, underdevelopment, monetary decay, destitution, social and sex imbalance and that's only the tip of the iceberg.

The middle age among the number of inhabitants in Somalia is just 18 years old, with a future of 52.8 years old generally speaking. Guys are relied upon to live to around 50 years, with females expected to live roughly 54 years. The present fruitfulness rate is holding at in excess of 5 youngsters for every lady, be that as it may, an excessively high pace of baby mortality exists - coming in with almost 100 newborn child passings for each 1,000 live births[50, 51].

#### **1.5 Electricity Supply in Somalia**

While the World Bank measures that 29.1 percent of the quantity of occupants in Somalia methodologies control, the later evaluation from the 2014 African Vitality Standpoint assesses that not actually a fourth of the people has the advantage of intensity. These assessments cloud an important provincial urban divide[50]. Power in nation zones is practically nonexistent. In urban zones, it changes on a very basic level the country over. Progressing examinations for Mogadishu and Hargeisa are 60 percent and 68 percent of the masses, independently, while more diminutive urban zones, as Merka, have only 23 percent related with electrical organizations. In zones with higher quantities of inside uprooted individuals who are more diligently to follow, the assessments of the extent with access to power are likely overstated[51].

While these rates, especially in Mogadishu and Hargeisa, are really higher than practically identical urban communities in sub-Saharan Africa, the power to which organizations and family units have access is tricky. The essential issue is that power levies are among the most elevated on the planet, differing from \$0.80 to \$1.50 per kilowatt hour. Similarly, the neighboring nations of Kenya and Ethiopia appreciate normal paces of \$0.15 and \$0.06, respectively.<sup>3</sup> In

addition to the fact that somalis are paying generously higher duties for power, yet they are likewise procuring significantly less. The Gross domestic product per capita gauge for Somalia is \$128, a small amount of the Gross domestic product per capita of \$454 in Ethiopia and \$942 in Kenya.<sup>4</sup> Somali natives live in perhaps the most unfortunate nation on the planet and pay probably the most noteworthy tax for power of any nation.

The variety in power levies inside Somalia is clarified by area and differential evaluating by energy suppliers. Individuals in areas that are a long way from urban focuses normally pay the most in vitality costs. Inside urban areas, duties change crosswise over various suppliers and suppliers don't really utilize a uniform rate among their own customers[551]. The absence of straightforwardness and consistency makes issues for clients just as providers who contend in the area.

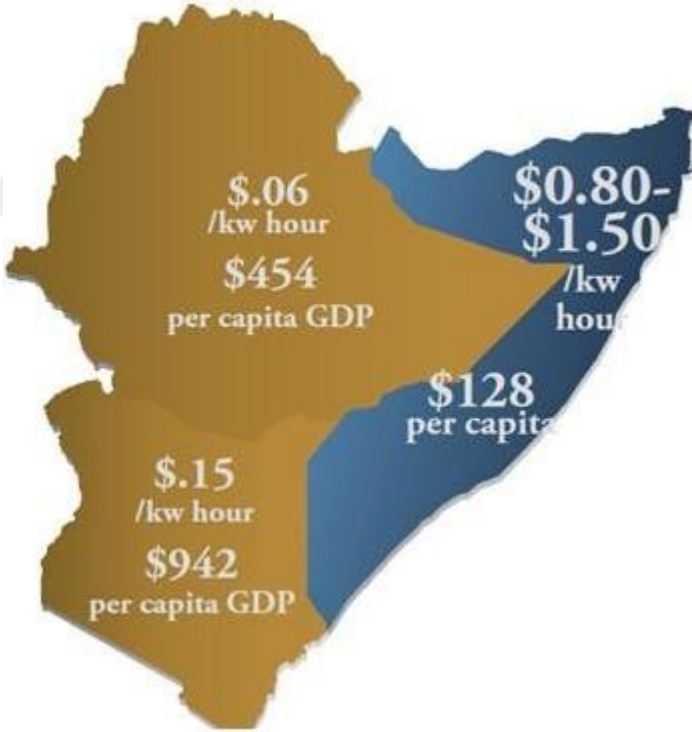

**Figure 1.1:** The price of electricity and per capita GDP in east africa including somalia

**1.6 Objectives Of The Study**

The Somalis populace is inconsistent appropriated. A large portion of Somalis live in the field and accordingly don't approach the national power matrix. In this way as nation's endeavor to improvement, they think of methodologies



including jolt, subsequently basic leadership on the best way to convey these administrations turns out to be hard.

The point of this proposition is to discover better choices on the most proficient method to viably utilize the accessible sustainable power source to convey zap in the nation. This is need to thusly complete a Multi criteria fundamental authority technique during essential initiative.

This assessment will investigate the Multi-Criteria Basic initiative Techniques fitting for making courses of action for the imperativeness issues impacting Somalia. The examination will study the Multi-Criteria Choice Examination unreliable energy springs and concentrate the reliable energy springs Arranging and Arrangement. The investigation will likewise take a gander at vitality issues influencing Somalia.

### **1.7 Methodology**

The Somalis masses is conflicting appropriated. An enormous segment of Somalis live in the field and in like manner don't approach the national power lattice. Along these lines as country's undertaking to progress, they consider procedures including shock, in this way essential authority on the most ideal approach to pass on these organizations ends up being hard.

The purpose of this suggestion is to find better decisions on the most capable strategy to feasibly use the available supportable power source to pass on zap in the country. This is need to thusly complete a Multi criteria fundamental initiative strategy during essential administration.

This assessment will investigate the Multi-Criteria Essential administration Methods proper for making game plans for the imperativeness issues affecting Somalia.

The examination will overview the Multi-Criteria Decision Assessment in Feasible power source and concentrate the Maintainable power source Masterminding and Course of action. The examination will in like manner look at essentialness issues affecting Somalia.



## **2. ENERGY RESOURCES USED IN SOMALIA**

### **2.1 Forms of Energy used in Somalia.**

Somalia is a nation that isn't honored with plenteous or sensible vitality assets, when contrasted with certain nations. In spite of the fact that, the nation has a measure of sun oriented vitality, hydropower, geothermal, biomass, and woodland spread, however a portion of these assets (geothermal and somewhat hydropower) can't be outfit for monetary worth since they are excessively little or potentially remotely found.

The common war in Somalia damagingly affects general administration in the nation, which additionally rises above to the vitality area of the nation. Prior to the common war, there was a structure that directed the age and circulation of power, however not so much practical, yet the common war pulverized all structures that would have supported the transport of capacity to the cross section.

The present imperativeness part in Somalia can be said to be a decentralized and a private division supply of intensity. The private portion or the independent power providers expected authority over the age and supply of intensity when it was clear the central government come up short on the ability to create and circulate power to the general population and organizations.

The activities of the private provider or free control provider is that they use presented generator (for the most part second from Dubai), which is controlled with imported fuel to give control to organizations and people in general. The private vitality supplier probably won't be perfect, yet they offer a transient arrangement in a nation in or leaving war like Somalia. Their focal points incorporate their capacity to effectively recognize and limit dangers related with business in their prompt condition. They additionally can pull in remote financial specialists. The drawback of such a training is, that they are generally insufficient and costly [1].

## 2.2 Energy Consumption and Production

The number of inhabitants in Somalia in 2013 was 15 million individuals (Table 1). Absolute power delivered in 2015 was 35 ktoe, with 97.1 percent created from petroleum derivatives. Last power utilization in 2015 was 28 ktoe (AFREC, 2015).

Key indicatorsAmount

Population(million) 15

GDP (billion 2005 USD) 3.12

CO2 emission (Mt of CO2) 0.89.

Somalia is separated into three principle areas Puntland, Somaliland, and South and Focal Somalia. Every one of these districts has its own power suppliers and systems, for example the duty of power supply has been decentralized, and moved to the private area [5].

Ente Nazionale Energia Electrical (ENEE) is burdened with the duty of power age, conveyance and supply in the whole Somalia [5].

The Nugal Electrical Organization (NEC), officially known as Nugal Electrical power Office (NEPA) is one of the real players in Somalia. Set up in 1971, the organization is situated in Garowe, Puntland Somalia. The organization is burdened with the obligations of producing, transmitting and conveying of power inside a geological region of Somalia [5].

The National Electric Power Co-activity (NEPCO) was set up on the first of May 2009. Its obligation to produce, transmit, and disseminate power to the City of Galkaio, Somalia [8]. Other eminent power suppliers are the Ethiopian Electric Power Enterprise (EEPCO), which supplies power to more than twelve towns in Somalia [11]. The Trans-National Modern Power and Gas Organization, an amalgamation of five organizations, supplies power to towns in Mogadishu.

[5] There is likewise Banadir Power Organization (BECO), and different various power suppliers in sub-locales of Somalia, which produce, transmit and disseminate power to their prompt condition [9].

Power stays one of the components that shapes the development and solidness of any economy. Moderate and dependable power improves the nature of lives of the individuals, support nearby showcases, diminishes joblessness rate or more all pull in outside speculator [10].

As indicated by a report, just 10% of Somali populace approaches power, the vast majority of the individuals who approach power lives in the urban regions of the nation. The expense of power in Somalia is one of the most noteworthy on the planet. In a layman's language, the expense of power can be said to be "one euro for every light every night", as costly as the expense seems to be, it isn't even dependable [10].

Because of the costly and temperamental nature of power in Somalia, the individuals have turn into different wellsprings of vitality to meet their every day needs. It was accounted for that biomass type energizes (charcoal or potentially kindling) represent practically 87% of Somalia's vitality utilization, while oil based commodity and electric power represent the rest, 13% .[10].The utilization of kindling and additionally charcoal as a vitality source damagingly affects nature, just as the strength of the individuals.

The difficulties of power in Somalia fixates on three primary elements [7];

I. Civil war and its outcome.

II.Collapse of the Local government, which lead to Autonomous power supplier (APS) to assume control over the obligations of age, conveyance and supply power in Somalia.

IIILack of Guidelines that controls the exercises of the Autonomous power supplier.

Somalia can be said to be a nation rising up out of right around 10 years; in length common war. The common war effectsly affected lives and properties in the nation. During the common war, government claimed generators and the national framework were annihilated. Despite the fact that, there have been endeavors to supplant as well as fix the harmed offices, however the weaknesses encompassing the nation has been devastating such endeavors. [7]

Since the breakdown of the Middle government in Somalia, free control suppliers (IPP) assumed control over the age and supply of power utilizing their own made networks. The greater part of the free control providers(IPP) adventure into the matter of intensity age and supply for the most part on the grounds that their very own privately owned businesses need power to run; subsequent to fulfilling their own needs, they supply power to households[1] . The vitality or power part is by and by not controlled by the administration; thus; the segment is inadequate with regards to the greatest limit and the fortitude to control the exercises of the Autonomous Power Suppliers (APS).The Autonomous Power Suppliers (IPP) exploit this hole, and work in any ways that will support their organizations, without thinking about the impacts (evaluating) on the individuals, just as the earth [7].

In Somalia, biomass represents practically 95% of the vitality source. This is because of costly and temperamental nature of power in the nation. Imported oil represents practically 3.98% of vitality source in Somalia [7].

In a normal house in Somalia, the utilization of power for house lighting and excitement (TV or potentially radio) are the most reason(s) for expending power. Multi day power profile of an example of certain houses demonstrates that a great deal of power is devoured between the long periods of 10:00 and 12:00, and 18:00 and 22:00 hours. [12]

As at 2015, the limit of the introduced power generator in Somalia is 80 megawatts (MW) [11] The net power delivered as at 2014 is 0.31 Billion Kilo-Watt hours. The utilization of power as at 2014 is 0.29 Billion Kilo-watt hours [13]. The generation and utilization of power in Somalia have been expanding in the ongoing years; this pattern can be ascribed to an expansion in populace and to the journey for satisfaction [12]. The primary wellspring of power generation is through imported oil based goods from abroad. Because of costly and inconsistent nature of power in Somalia, individuals have depended on the least expensive and solid wellspring of vitality which is kindling and additionally charcoal.

**Table 2.1:** Installed Generators and Capacities from IPPs

LOCATION	OWNERSHIP	NO.* SIZE(KW) OF UNITS INSTALLED
----------	-----------	----------------------------------

Garowe,Nugal	Nugal cooperative	Electric	2x280 1x250 1x100
Bosaso,Bari	Somali Tech		3x600
Hargeisa,Somaliland	Somaliland Agency	Electricity	1x1250 3x1500
Gardo,Bari	Somali Tech		2x140

It can be concluded from Table 1 above shows the sizes or capacities of installed generators for different independent power providers (known) and their quantities. From table 1 above it can be concluded that of the known Independent power providers with known data, Somaliland Electricity Agency has the highest generating capacity with 5750KW, while Somali Tech has the lowest with 280KW.

**Table 2.2:** Average daily electricity consumption of a household in Somalia

Load Usade	Power consumption	Time (hours)	Kwh(consumption)
Tv and Media	250	12	3
Lighting	200	12	2.4
refrigerator	80	24	1.92
Wahsing machine	450	2	0.9
Electronics	150	12	1.8
Iron	1000	1	1
Other electro	150o	10	15
Daily consumption single household			26.02

Table 2 above shows how electricity is consumed in a typical Somalia house. An average Somali uses electricity mainly for entertainment and for illumination or lightening. A Somali is likely to watch TV and Multimedia for twelve hours in a day, which is equivalent to 3KWH electricity consumption. Electricity is consumed for twelve hours for lightening.

### **2.3 Transmission lines that is used in Somali power systems**

As I referenced before Somali electrical organizations utilizes an extremely essential transmission lines like copper wires to supply capacity to the customer.

These little private generators transmit the electric power from close-by creating office and they don't utilize huge power transformer to expand the voltage for transmission to far off location.[11]

We have to get an enormous number of transformers to increment or diminishing the substituting voltages in electric power applications to separate the customers that need high number of electric power like ventures likewise the customers that needs a less number of electric power like homes.

### **2.4 How To Build Electric Power in Somalia**

The flow vitality in Somalia is low and the all out introduced vitality particularly power is around 175-185 MW in this investigation I might want to look a few different ways to increment and improve the present vitality framework in Somalia by usage of sustainable power sources .

Solar energy

Daylight based imperativeness is splendid light and warmth from the Sun that is harnessed using an extent of consistently propelling developments, for instance, sun arranged warming, photovoltaics, sun situated warm essentialness, sun fueled designing, fluid salt power plants and phony photosynthesis.

It is a critical wellspring of practical power source and its advancements are broadly portrayed as either reserved daylight based or dynamic sun arranged depending upon how they catch and pass on sun based essentialness or convert it into sun based power. Dynamic sun arranged systems consolidate the use of photovoltaic structures, concentrated sun based power and sun based water heating to harness the imperativeness. Unapproachable sun fueled frameworks consolidate orchestrating a structure to the Sun, picking materials with incredible warm mass or light-dispersing properties, and arranging spaces that regularly course air.



There is some possibility to utilize the rich sun based vitality assets and without a doubt it is as of now being abused. The most well-known utilizations incorporate lighting, cooking and water siphoning and warming in both open and private structures. Somalia gets a normal sunlight based insolation of somewhere in the range of 5 and 7 kWh/m<sup>2</sup>/day converting into a complete vitality limit approximately 2,163 MN MWh/year .

Normal insolation remains at 5-7 kWh/m<sup>2</sup>/day. With more than 3,000 hours of high and consistent daylight every year, Somalia is in a perfect world set to use sun based vitality. Sun based assets have been used for off-lattice age in the nation, just as for water warming for city structures. Sun oriented cooking has likewise observed some take-up in the nation, and sun based power is viewed as the vitality wellspring of decision for the recovery of numerous civil structures in the nation, especially wellbeing focuses.

Global horizontal irradiation

Africa and Middle East

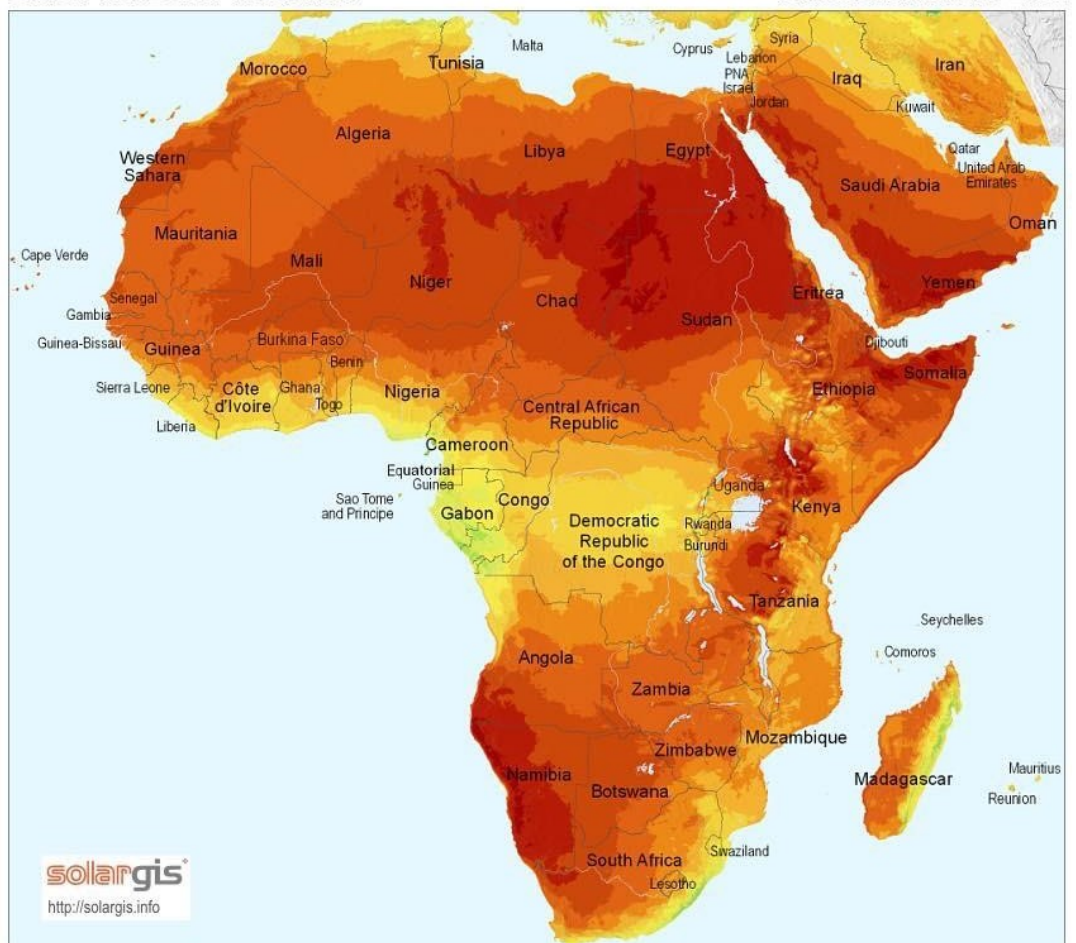

Average annual sum (4/2004 - 3/2010)  
 < 1600 1800 2000 2200 2400 > kWh/m<sup>2</sup>

© 2011 GeoModel Solar s.r.o.

### **Figure 2.1: Solar energy potential in somalia**

The above figure shows us the amount of solar energy received by africa continent per annual somalia is the one of african countries that receive most of solar energy as it shows the figure .

### **Biomass**

Charcoal is an imperative money related industry in Somalia. It gives both compensation and the people's imperativeness needs. Around 97 percent of urban nuclear families depend upon charcoal while rural families rely upon fuel as their standard wellspring of imperativeness (AfDB, 2013). In the five years from 2010, the proportion of charcoal made about increased from 523 to 926 ktoe in 2015 (AFREC, 2015). This is putting gigantic load on the forested areas resource, adding to desertification and the destruction of contacting and arable land. For instance, boondocks spread in 1985 was around 60 percent of the land zone yet by 2001, this had declined to around 10 percent of land zone or about 6.5 million ha (REEEP, 2012). There is squeezing necessity for elective wellsprings of fuel and proposals have exhibited biofuels from reap and animal wastes and marine biomass (REEEP, 2012). Moreover, improved headways for sensible charcoal creation should be made (REEEP, 2012).

In 1985, lavish regions in Somalia were assessed to be around 39 million hectares – by and large 60% of Somalia's region area. As a result of overexploitation these figures have diminished on a very basic level. In 2001, estimations demonstrate that the forest spread may have been as low as 10%. Solid and liquid biomass decisions in Somalia still hold an immense potential, in any case, essentially as collect and animal wastes, and marine biomass. Supportable charcoal creation systems could in like manner be used to exceptional effect in the country, as current charcoal age is causing critical normal impacts.

Biomass is the term used for all characteristic material beginning from plants (checking green development), trees and crops and is essentially the get-together and limit of the sun's essentialness through photosynthesis. Biomass imperativeness, or bioenergy, is the difference in biomass into supportive sorts of essentialness, for instance, warmth, power as well as fluid forces.

Ecosystem for living vitality it is from either truly from the earth, to give imperativeness products, or to bring stores made treatment that harvests sustenance in other various things, for instance, crush and paper from the wood business. Another critical duty is from post buyer development streams, for instance, improvement and pulverization wood, beds used in transportation, and the flawless division of metropolitan solid waste (MSW).

The biomass to bioenergy structure can be considered as the organization of stream of sun situated made materials, sustenance, and fiber in our overall population. These interrelationships are showed up in Figure 1, which displays the distinctive resource types and applications, exhibiting the movement of their accumulate and stores to bioenergy applications. Not all biomass is clearly used to convey imperativeness yet rather it might be changed over into widely appealing essentialness transporters called biofuels. This consolidates charcoal (higher imperativeness thickness solid fuel), ethanol (liquid fuel), or producer gas (from gasification of biomass).

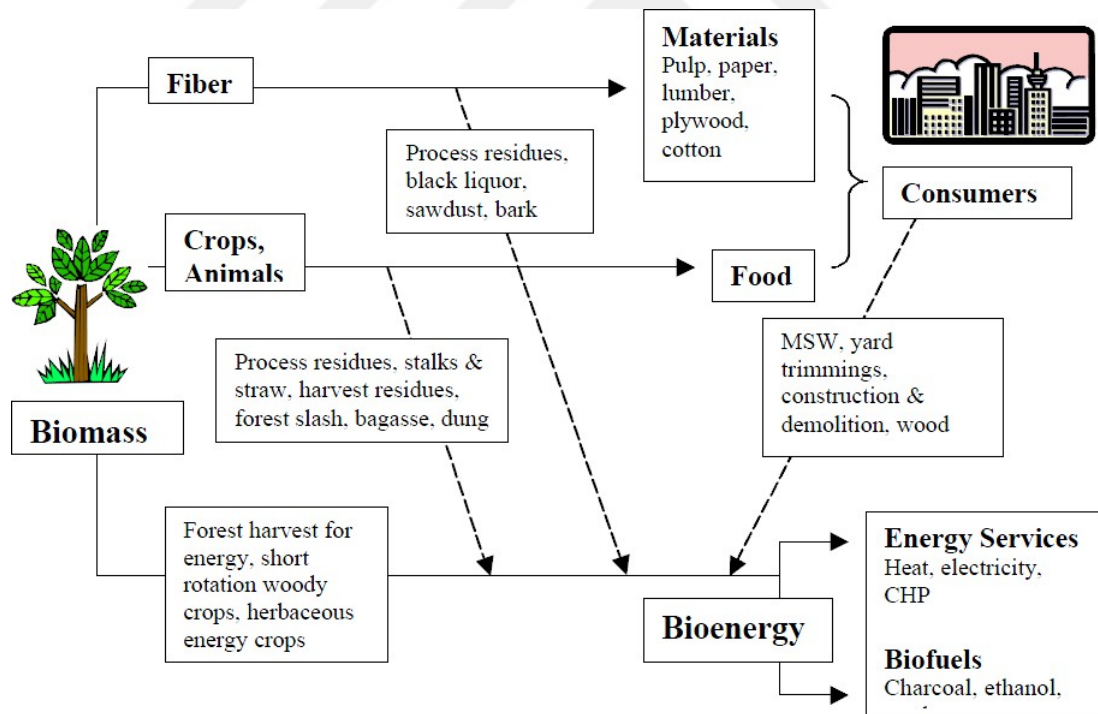

**Figure 2.2:.** Biomass and bioenergy flow chart

**Source:** R.P. Overend, NREL, 2000

Biomass was the principal vitality source bridled by people, and for about all of mankind's history, wood has been our overwhelming vitality source. Just during

the only remaining century, with the advancement of effective systems to concentrate and consume petroleum products, have coal, oil, and gaseous petrol, supplanted wood as the industrialized world's essential fuel. Today somewhere in the range between 40 and 55 EJ every time that ecosystem is utilized considering vitality, unfitted around four hundred gifty every time considering all out vitality utility, as expected ten and fourteen %, making it the fourth biggest wellspring considering vitality next to oil (thirty-three %), coal ( twenty one%), also flammable gas (nineteen %). Right sum is unsure on grounds that the greater part is utilized non-industrially in creating nations.

Biomass is generally not considered an advanced vitality source, given the job that it has played, and keeps on playing, in most creating nations. In creating nations regardless it represents an expected 33% of essential vitality utilize during most unfortunate near ninty percentage of all vitality that provided by ecosystem.

More than 2B individuals baker beside striaght burning of ecosystem, furthermore, such ordinary employments regularly include wasteful utilization of ecosystem powers, to a great extent from minimal effort sources, for example, characteristic woodlands, which can further add to deforestation and natural corruption. The immediate ignition of biomass energizes, as utilized in creating nations today for local cooking and warming, has been classified "the poor man's oil" positioning at the base of the stepping stool of favored vitality bearers where gas and power are at the top.

The image of biomass use in creating nations is pointedly differentiated by that in industrialized nations. By and large, biomass represents 3 percent or 4 percent of all out vitality use in the last mentioned, despite the fact that where approaches steady of biomass use are set up, for example in Austria, Sweden, and Finland, the biomass commitment arrives at 12, 18, and 23 percent individually. Most biomass in industrialized nations is changed over into power and procedure heat in cogeneration frameworks (consolidated warmth and power generation) at modern destinations or at city locale warming offices. This empowers a more noteworthy assortment of vitality administrations to be gotten from the biomass which are much cleaner and utilize the accessible biomass assets more effectively than is regular in creating nations.

Biomass vitality can possibly be "modernized" around the world, that is created and changed over proficiently and cost-aggressively into progressively advantageous structures, for example, gases, fluids, or power. An assortment of advancements can change over strong biomass into spotless, advantageous vitality bearers over a scope of scales from family unit/town to huge mechanical. A portion of these advancements are financially accessible today while others are still in the improvement and exhibition stages. In the event that broadly executed, such innovations could empower biomass vitality to play a substantially more huge job later on than it does today, particularly in creating nations.

### **Hydropower**

The sending of hydroelectricity has been genuinely hampered by the security situation in this country. At the present time simply 2.85 percent of hard and fast power is created from hydropower (AFREC, 2015). The in-country potential for hydropower is evaluated at some place in the scope of 100 and 120 MW of which only 4 percent has been mishandled on the Juba stream (REEEP, 2012). A dam at Bardhere, in southern Somalia, has moreover been orchestrated. Various challenges to the division join the normality of the streams.

Potential is assessed at 100-120 MW. Beginning at 1985, this hydropower potential was, as it were, unfamiliar, with simply 4.8 MW mishandled on the lower Juba valley (pre-war estimates). Somalia has the most insignificant usage of present day sorts of essentialness in Sub-Saharan Africa. Somalia has since a long time back relied upon fuel wood moreover, charcoal, and imported oil to meet its imperativeness needs. Fuel and charcoal are the genuine wellsprings of imperativeness, speaking to by a wide margin the majority of the country's total essentialness use. There are no tremendous dams in Somalia, with diesel generators being the rule wellspring of essentialness. Somalia is in like manner a concentrated on individual from the East African Power Pool , a regional affiliation dedicated to organizing the power frameworks of the East African countries, to improve imperativeness security and the sufficiency of supply in the district.

### **Oil and natural gas**

Somalia's geology, and closeness to ordinary oil creators in the Middle East, exhibits the potential nearness of oil spares (AfDB, 2013). Up until this point, regardless, the condition has not been useful for examination works out. There are signs that the Dharoor field in Bari territory, Puntland has about 1.2 billion barrels of oil with the capacity of practically on numerous occasions that in stores and additional potential for toward the ocean oil and vaporous petroleum age in the Indian Ocean and the Red Sea (Balthasar, 2014). Somalia depends upon imported oil for power age and in 2015 97 percent of the power was conveyed by oil signifying 34 ktoe (AFREC, 2015). Net imports of oil in 2015 were 131 ktoe (AFREC, 2015). The one handling plant stopped exercises in 1991 when the political situation disintegrated (REEEP, 2012).

### **Wind**

The expansive coastline with the closeness of engaging offshore breezes credits itself particularly to the time of wind imperativeness. Estimations of wind rates have gone from a low of 3 m/s to a high of 11.4 m/s (FGS, 2015). Wind essentialness has been utilized for over 70 years fundamentally for water siphoning. REEEP (2012) measures that an enormous part of the land area has proper breeze speeds for power age and this could help moderate a segment of the present loads on forests for biomass imperativeness and override a segment of the diesel control generators subsequently adding to radiations decline (REEEP, 2012).



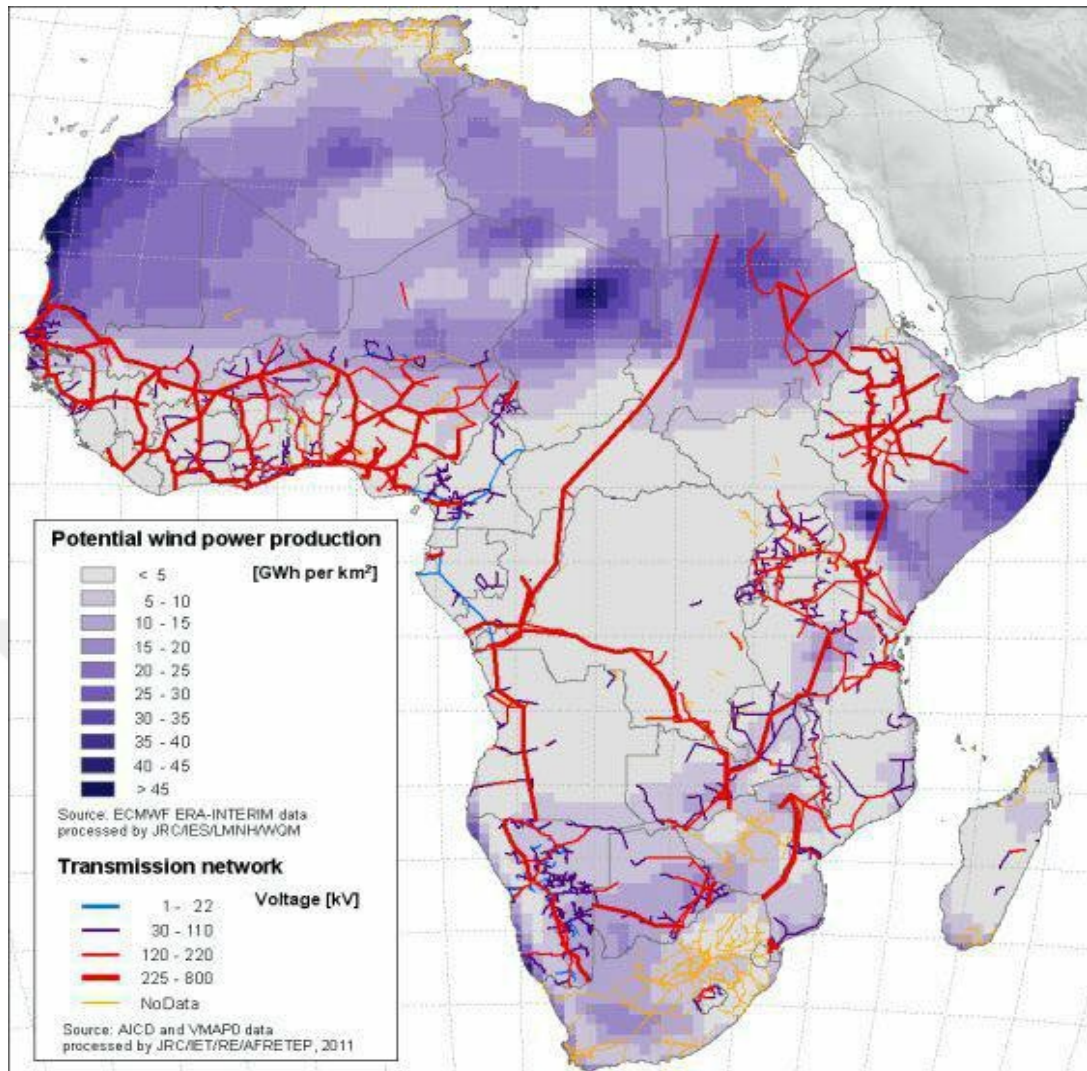

**Figure 2.3:** Wind energy potential in africa

The above figure shows us the amount of wind energy recieved by africa continent per annual somalia is the one of african countries that recieve most of wind energy as it shows the figure .

### **Geothermal energy**

Accessible information demonstrates that the geothermal vitality potential is too low to even think about being financially abused for power age. The signs for geothermal potential are poor (REEEP, 2012). Warm vitality is a noteworthy wellspring of power and the use of sustainable power source assets, for example, sun oriented, hydroelectric and wind are openings that could be utilized to decrease commitments to worldwide environmental change.

Renewable Energy Market Overview

The Somali vitality market has developed as of late, because of expanding interest for and utilization of vitality items and administrations. However the dispersion of these items (especially into provincial territories) stays unique and costly, making them generally blocked off to bits of the Somali populace. In contrast with power costs in Ethiopia and Kenya, at \$0.15 and \$0.06 per kw hour respectively<sup>1</sup>, the duty is restrictive in the Somali area at around \$0.80 to \$1.50/kw hour.<sup>2</sup> Somali organizations battle to work and draw in financing in light of the fact that privately made items can't successfully contend on value in respect to imports because of the staggering expense of vitality. Moreover, the proceeded with dependence on charcoal in numerous provincial regions is devastating the earth and has negative ramifications on general wellbeing markers. This more extensive setting underscores the developing requirement for increasingly moderate, clean, and economical vitality items all through the locale [30, 31, 32].

There is huge potential in economical power source creation over the Somali area. Starting at now, interests in the feasible power source industry in Africa and the Middle East are rapidly growing, and in Somalia and Somaliland, more than 20 economical power source related undertakings have begun once again the latest three years, focusing on sun arranged home systems, maintainable power source age for little scale grids, daylight based street lighting, mixed system structures, and wind turbine installation.<sup>3</sup> Conditions in this district are particularly sensible to the headway of sun based and wind developments.

The Somali region has the most flawlessly awesome conditions in Africa for the headway of the breeze essentialness division. Little windmills are starting at now being used all through the region to control water framework; and could be stretched out to help water extraction from boreholes and power ice making and refrigeration[43].

Also, the sun arranged essentialness part in like manner has the potential for improvement; the Somali area boasts some the most raised step by step paces of daylight based radiation in the world.<sup>5</sup> Solar advancement has the advantage of a lower repeat of breakdown appeared differently in relation to other imperativeness sources, which can bolster common and remote systems get to strong power. Sun fueled imperativeness advancements are being used for



various purposes in the Somali region, including water siphoning, water framework, lighting, and refrigeration of little fish in shoreline front towns [41].

Wind and sun powered advancements are especially significant for provincial zones, where huge power generators are excessively expensive, wasteful, and not monetarily feasible. Further advancement of sustainable power source innovations is a successful option in contrast to satisfying the vitality need all through a significant part of the nation [45, 51]. In any case, developing this division requires critical interests in innovations and human capital. While all respondents to the Somali Renewable Energy Skilled Workforce Survey showed that interest for sustainable power source items and administrations is expanding because of expanded power utilization, they additionally concurred that expenses can be restrictive, driving the requirement for less expensive alternatives[46, 48]. Respondents likewise recognized that fruitful development of this industry requires teaching neighborhood networks on sustainable power source innovations with the goal that more individuals comprehend its uses and advantages. While learning of these items is developing, as indicated by overview respondents, progressively instructive assets are required.

Maybe the most significant finding was that the size of the Somali sustainable power source workforce isn't adequate for sustainable power source organizations to satisfy future market needs. This was observed to be an aftereffect of an absence of value instructive and preparing programs in explicit sustainable power source advances, underscoring a requirement for noteworthy interest in this area[42].

There is additionally an absence of viable state the executives over and conveyance of vitality, which has made a space for IPPS to develop without clear guideline. Specifically, the arrangement of vitality by privately owned businesses is expanding for the most part in Somaliland. In any case every single nearby government are starting to organize the advancement of this sector[42]. A local vitality strategy made by the Somaliland government and endeavors to draft laws to manage the vitality segment are indispensable strides in further building up this segment.

Local energy systems planning

A neighborhood vitality framework can be unpredictable from a few points of view: specialized, monetary and hierarchical. Such a framework can incorporate a few vitality assets, a few vitality bearers (power, locale warming, gas, and later on perhaps at the same time hydrogen) and an expanded vitality request (Figure 1). The supply side of the framework can comprise of both nearby and imported vitality assets. A portion of the vitality assets, for example, gas or kindling, can be used legitimately toward the end-client area. The advancement of new innovations for disseminated age has changed a portion of the conventional end-clients in the framework (chiefly modern clients) into providers of power or warmth. At the interest side of the framework, the vitality meets various significant administrations in the public arena, for example, warming, lighting, mechanical work and so forth., both in the modern and private segments.

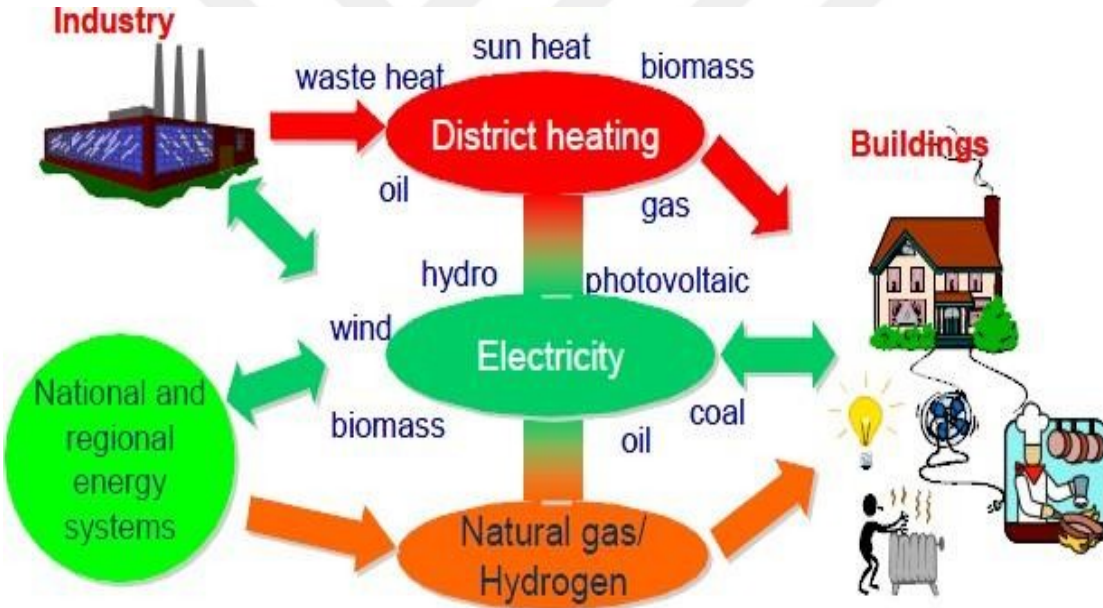

**Figure 2.4:** A local energy distribution system.

The neighborhood organizers, in numerous nations, are right now stood up to with new challenges. For the time being, the greatest test is to comprehend the unpredictability that the rebuilding of the vitality area and the improvement of various vitality markets, are adding to the basic leadership process[27]. Additionally, the by and large inspected environmental issues and the consistent depletion of basic resources are giving new estimations to the orchestrating issue in the medium and long run. Accordingly, there is a necessity for new

masterminding frameworks and gadgets, in order to propose courses of action both for the short and long run [27,28].

The accompanying zones will give a couple of principles for the route toward appreciation and sorting out the essentialness system orchestrating issue. The spotlight will be resolved to four key segments: 1) boss and various accomplices connected with the close-by orchestrating; 2) the huge number of criteria and conflicting objectives; 3) the central vulnerabilities identified with the organizing issue and 4) potential alternatives.

## **2.5 Decision makers and stakeholders in the local energy system**

The quantity of leaders engaged with the arranging of nearby vitality circulation systems will rely upon the real circumstance at the particular area. Notwithstanding, when all is said in done we distinguish three significant gatherings of chiefs: vitality circulation organizations, administrative bodies and experts. The most unmistakable gathering in the framework is shaped by the dissemination organizations for various vitality transporters, as these organizations settle on the venture choices. Since vitality appropriation through systems is a characteristic imposing business model, the dispersion organizations don't have to stress over challenge from other investors[1,11]. Be that as it may, if distinctive appropriation organizations are accountable for the diverse vitality systems, there will be rivalry between the vitality transporters about gathering the vitality needs of the end-clients. Co-ordinated arranging is consequently troublesome in this circumstance, as each organization is just worried about streamlining activity and interests in its very own conveyance arrange. Interests in other circulation systems will be an unsure variable not a choice variable, for each decentralized chief [5,18]. In certain circumstances the circulation organization will make a consolidated investigation of interests in both creation and dissemination offices. For power, the progressing business rebuilding tend to separate creation and dispersion, while for locale warming vertically incorporation is commonly still the case.

Since dissemination of vitality is a characteristic imposing business model, the framework controllers will assume a urgent job in choosing an administrative structure, through which the circulation organizations are given the right

motivating forces to put resources into new foundation. Purported motivating force based guideline is much of the time used to accomplish cost effective dissemination frameworks for vitality. Different destinations can likewise be accomplished through motivating force components [31]. Nonetheless, more straightforward guidelines, for example regarding detail of necessities for framework unwavering quality or confinements of destructive outflows, are some of the time likewise required. At the point when a few vitality bearers are included, there is a test for the controllers to structure a reliable arrangement of guidelines, which considers the interaction between the vitality transporters. A typical administrative body for all vitality transporters would be a bit of leeway in such circumstances, so as to accomplish well-organized guidelines for activity and extension of neighborhood vitality frameworks [29,31].

At a considerably more elevated amount of conglomeration in the framework, the experts will have a significant job as a leader in the nearby vitality framework. In numerous nations usually neighborhood or territorial specialists possess the vitality dispersion organizations (at any rate halfway) [57,31]. Thus, these specialists can likewise apply direct control on the venture choices. There are numerous partners associated with nearby vitality framework arranging. Some of them can likewise be leaders, while others are for the most part influenced by the ultimate result without straightforwardly participating in the choice process[29,31]. For example, from the last gathering, the free control age organizations will clearly be influenced by the dissemination framework arranging, since the foundation ventures will affect the interest for power. Essentially, free providers of oil, gas and area warming to the dissemination systems will likewise be influenced. The end-clients are critical partners in the framework, since they are the customers of the administrations that the vitality systems convey. Distinctive end-client gatherings won't really have similar interests or a similar capacity to impact major decisions[62,63]. For example, all things considered, private clients have unexpected destinations in comparison to modern customers. Indeed, enormous scale shoppers can at times likewise be considered as leaders, since they in specific circumstances can choose which vitality appropriation systems to associate with and make the essential framework speculations themselves accordingly[58,60]

### 3. OVERVIEW OF MULTI-CRITERIA DECISION-MAKING METHODS

Multi-criteria decision making (MCDM) is a discipline in its own right, which deals with decisions involving the choice of a best alternative from several potential candidates in a decision, subject to several criteria or attributes that may be concrete or vague. Many standard planning techniques are a part of activity analysis, also a notable area of basic leadership. These techniques also deal with the two surveyable just like subjective standard and examine strife standard as well as leaders (57). A couple of request and course of action exist yet when all is said in done these methods can be disconnected into two orders: multi-target essential authority and multi-trademark fundamental administration. In multi-trademark essential authority, the decision issue is depicted by the nearness of various and forceful goals that must be updated opposite a great deal of achievable and accessible pressure instead of, as in MADM, the examination of a huge amount of options against a huge amount of criteria. MADM is one of the most standard frameworks to be gotten a handle on to deal with issues related with substitute points of view (57). They consist of a few unique techniques for which major basics are research development process, selecting highest coordinator technique.

There may be mixes of the above methods. Dependent upon the amount of boss, the procedures can be named single or aggregate decision making methods. Fundamental initiative under powerlessness and decision genuinely steady systems are in like manner observable essential administration strategies [14].

These approaches share ordinary qualities of dispute among criteria, extraordinary units, and difficulties in selection of choices. In various objective fundamental administration, the decisions are not fated yet rather a ton of objective limits is upgraded subject to a great deal of constraints [53,57]. The most acceptable and beneficial course of action is searched for. In this perceived capable game plan it is impossible to hope to improve the display of any

objective without defiling the introduction of in any occasion one other objective. In various quality decision making, couple of decisions are to be surveyed against a great deal of characteristics which are normally hard to quantify. The best alternative is for the most part picked by causing relationships between's choices with respect to each to attribute[62,57].

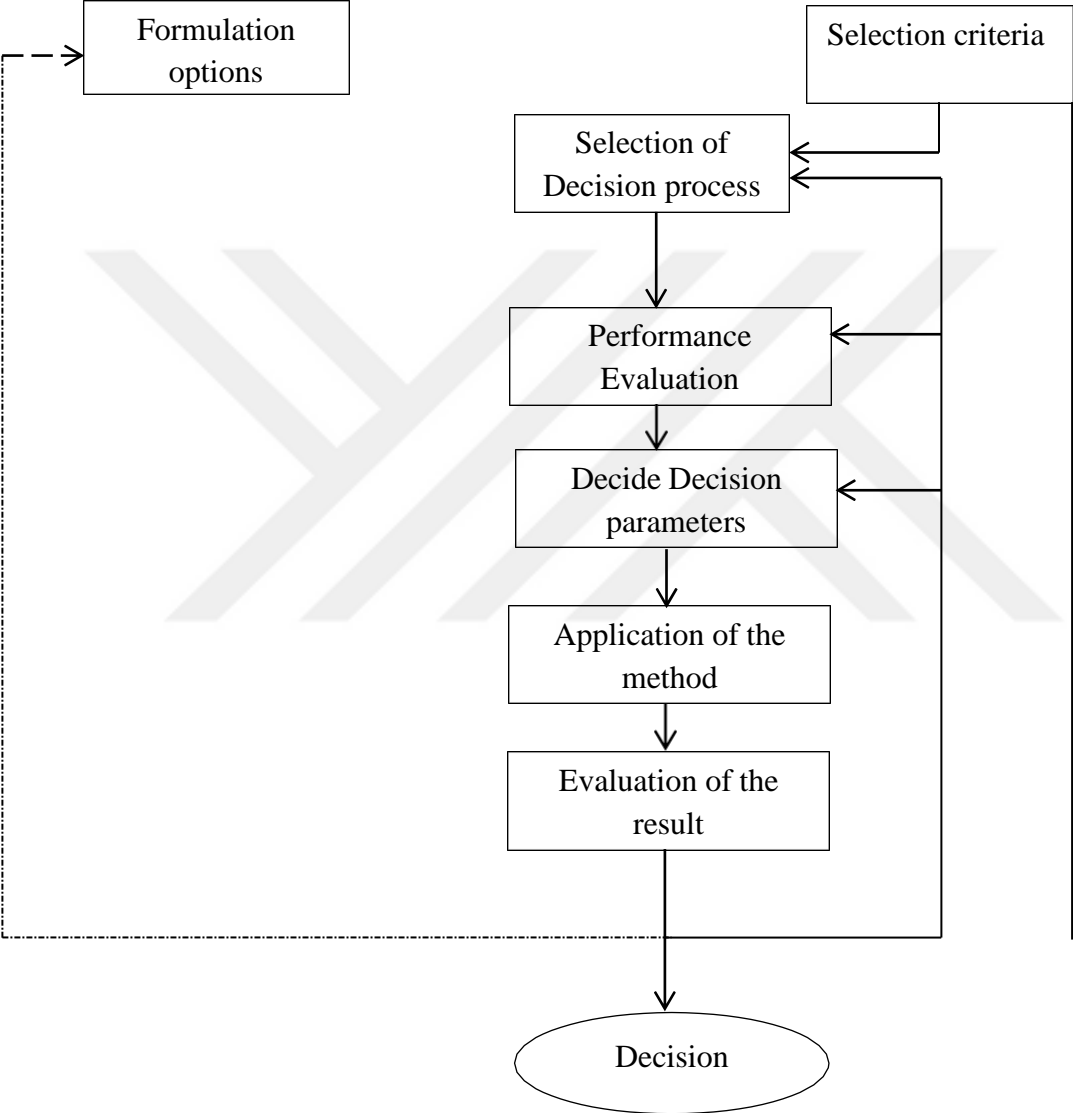

**Figure 3.1:** Multi-criteria decision process

### 3.1 Multi-Criteria Decision-Making Methods

The primary target of this technique it's for choosing their elective which own most elevated points as indicated by arrangement assessment criteria. Distinct outline that regularly utilized many option basic leadership strategies is displayed underneath:the methods that has been explained in this study is classified in two five mothed as follows.

#### 3.1.1 Weighted sum method (WSM)

The WSM is the most generally utilized methodology, particularly in single dimensional issues. In the event that there are M options and N criteria, at that point the best option is the one that fulfills the accompanying articulation:

$$A^*_{wsm} = \max \sum_{j=1}^n \sum_{i=1}^m a_{ij}w_j \quad \text{for } i = 1,2,3, \dots, m \quad j = 1,2,3, \dots, n$$

(3.1)

where A(WSM score ) is the WSM score of the best alternative , $a_{ij}$  is the actual value of the  $i$ th alternative in terms of the  $J$ th criteria , $W_j$ =the weight of importance of the  $J$ th criteria .The all out estimation of every option is equivalent to the total of items. Trouble with this strategy rises when it is connected to multi-dimensional basic leadership issue.

In consolidating various measurements, and therefore various units, the added substance utility supposition that is disregarded [15].

$$R(A_K/A_L) = \prod_{j=1}^N (a_{Kj}/a_{Lj})^{w_j},$$

(3.2)

where  $a_{Kj}$  is the genuine estimation of the  $i$ th elective as far as the  $j$ th model, and  $d_{Lj}$  is the heaviness of significance of the  $j$ th measure. On the off chance that  $R(A_K/A_L)$  is more prominent than one, at that point elective  $A_K$  is more attractive than elective  $A_L$  (in the boost case). The best option is the one that is superior to or if nothing else equivalent to the various choices [16].

#### 3.1.2 Scientific Hierarchy Process (AHP)

Scientific Hierarchy Process (AHP) is created by Saaty [17,18]. The quintessence of the procedure is deterioration of a perplexing issue into a chain

of command with (objective) at the highest point of the pecking order, paradigms and sub-standards at levels and sub-levels of the progressive system, and choice options at the base of the chain of importance, components at given progressive system level are contrasted two by two with evaluate their relative inclination as for every one of the components at the following higher level. The verbal terms of the Saaty's principal size of 1–9 is utilized to evaluate the power of inclination between two components. The estimation of 1 demonstrates equivalent significance, 3 respectably progressively, 5 unequivocally increasingly, 7 in all respects emphatically and 9 shows incredibly more significance. The estimations of 2, 4, 6, and 8 are dispensed to show bargain estimations of importance[15]. Proportion scale and the utilization of verbal examinations are utilized for weighting of quantifiable and non-quantifiable components.

The strategy figures and totals their eigenvectors until the composite last vector of weight coefficients for options is acquired. The sections of definite weight coefficients vector mirror the relative significance (esteem) of every option as for the objective expressed at the highest point of hierarchy[14].

In the wake of acquiring the weight vector, it is then duplicated with the weight coefficient of the component at a higher level (that was utilized as foundation for pair insightful correlations). The method is rehashed upward for each level, until the highest point of the chain of command is come to. The general weight coefficient, as for objective for every choice option is then obtained[14,40]. The option with the most noteworthy weight coefficient worth ought to be taken as the best elective. One of the significant focal points of AHP is that it computes the irregularity record as a proportion of the leader's irregularity and haphazardly produced list [14,40]. This file is significant for the leader to guarantee him that his decisions were steady and that a ultimate conclusion is made well. The irregularity file ought to be lower than 0.10. Albeit a higher estimation of irregularity record requires re-assessment of pair savvy examinations, choices acquired in specific cases could likewise be taken as the best elective. In spite of the fact that AHP is anything but difficult to utilize and apply, its unidirectional relationship trademark can't deal with the intricacy of numerous issues ANP, be that as it may, manages the issue as a system of



complex connections among choices and criteria where every one of the components can be associated.

### 3.1.3 Preference ranking organization method for enrichment evaluation

#### (PROMETHEE):

This method is characterized by ease of use and decreased complexity. It uses the outranking principle to rank the alternatives and performs a pair-wise comparison of alternatives in order to rank them with respect to a number of criteria. Up to now, the family of PROMETHEE have included PROMETHEE I & II [14,40].

This method uses the outranking principle to rank the alternatives combined with the ease of use and decreased complexity. It performs a pair-wise comparison of alternatives in order to rank them with respect to a number of criteria. Brans et al. [19] have offered six generalized criteria functions for reference namely, usual criterion, quasi criterion, criterion with linear preference, level criterion, criterion with linear preference and indifference area, and Gaussian criterion. The method uses preference function  $P_j(a, b)$  which is a function of the difference  $d_j$  between two alternatives for any criterion  $j$ , ie  $d_j = f(a, j) - f(b, j)$ , where  $f(a, j)$  and  $f(b, j)$  are values of two alternatives  $a$  and  $b$  for criterion  $j$ . The indifference and preference thresholds  $q'$  and  $p'$  are also defined depending upon the type of criterion function. Two alternatives are indifferent for criterion  $j$  as long as  $d_j$  does not exceed the indifference threshold  $q'$ . If  $d_j$  becomes greater than  $p'$ , there is a strict preference. Multi-criteria preference index,  $\pi(a,b)$  a weighted average of the preference functions  $P_j(a, b)$  for all the criteria is defined as .(in this equation positive and negative  $\Phi$  represents outrangings )

$$\pi(a, b) = \left[ \sum_{j=1}^n W_j P_j(a, b) \right] / \left[ \sum_{j=0}^k \right] \quad (3.3)$$

$$\varphi^+ = \frac{1}{n-1} \sum_{b=1}^n \pi(a, b)$$

$$\varphi^- = \frac{1}{n-1} \sum_{b=1}^n \pi(a, b)$$

$$\Phi(a) = [\Phi^+(a)] - [\Phi^-(a)]$$

### 3.1.4 The Elimination and Choice Translating Reality (ELECTRE):

This method is set up for managing discrete criteria of two of them calculatable and unique in automatically and gives total referencing of the choices. The evaluation is rotated around the power depends the choices. Its depends upon the dominating relationships and misuses of accord. The dominating method utilize twin connection among options [41].

## 3.2 .Renewable energy resources :Solar energy in Somalia

### 3.2.1 Brief History Of Photovoltaic Technic

In 1839, ANTOINE BECQUEREL discovered that the light energy generated by the sun can be transformed into electrical energy by the photovoltaic effect. In 1930, helio electricity appeared with copper oxide cells and silicon . Around 1954, the possibility of providing energy was realized. The first terrestrial uses appear around the 70's. Global production of photovoltaic modules increased from 5 MW in 1982 to more than 18GWc in 2013.

### 3.2.2 Conversion Of Solar Energy Into Electrical Energy

To be usable, solar energy must be transformed into electrical energy. The conversion of solar energy into electrical energy is possible thanks to the photovoltaic panels. Photovoltaic is the direct conversion of sunlight to electricity.

The figure below shows how the conversion of solar energy into electrical energy is done

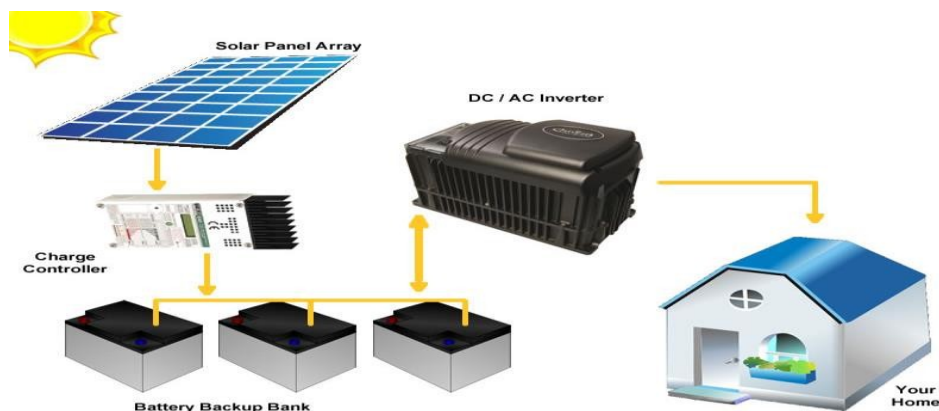

**Figure 3.2:** Basic diagram for photovoltaic installation

The solar panel is exposed towards the sun. This one recuperates the sunlight and transform it into the electrical current. This electric current is afterwards sent to the accumulator batteries passing through the charge controller. The current sent to the batteries is the DC current. From the batteries, the inverter transforms the DC current stored in the batteries into AC current. The inverter also adapts the voltage stocked in batteries to the domestic nominal voltage. Then the electrical energy is available for use.

Photovoltaic system is mainly composed by solar array, charge controller, battery, inverter, DC load, AC load as shown on figure below.

### **3.2.3 How Solar Energy May Increase Access To Electricity In Somalia**

As seen in previous chapters, the energy system in Somalia is marked by a very remarkable energy deficit. All electrical power installed in Somalia remains below to 100 MW. Demand is far higher than supply. The minimum power required by 2020 is of the order of 280 MW, whereas the new programs in progress expect to reach only about 180 MW more by this time; energy requirements for the mining sector are estimated between 300 and 800 MW in the next 10 years for the nickel industry alone and its associated minerals; the electrical installations are very old and cause a lot of losses [19].

However, as already it have been mentioned in the previous chapters, the solar field of Somalia is very interesting. The average sunshine received annually is close to 2,000 kWh / m<sup>2</sup>.year which are equivalent to the best European regions (southern Mediterranean) [20]. Despite the significant cloudiness due to the equatorial situation of Somalia and periods of rain, the exploitation of solar energy in Somalia is therefore an interesting solution to electrical energy deficiency. The production of electricity by solar energy can be achieved by photovoltaic technology or by thermal solutions. In the case of Somalia, only the photovoltaic option seems appropriate [20].

To see its importance, we can, by the sun, define five particular types of uses that could meet needs in Somalia.

- Rural electrification by photovoltaic kits
- Solar pumping

- Isolated photovoltaic generators
- Hybrid photovoltaic plant for isolated centers
- Photovoltaic power plants connected to the grid

The different visions of the Republic of Somalia, whether Vision 2025, Vision 2045 and others, predict that Somalia will no longer be among the poorest countries but rather among the emerging countries. In this way, the energy sector is one of the key sectors for this change. It is expected that the country will see the industries increase, the cities will expand and their number will increase, the roads will be lit, the population will also increase and its standard of living will improve and even the energy consumption will increase in turn.

Photovoltaic solar energy is suitable for the electrification of isolated centers or mini thermal-photovoltaic hybrid plants. With a view to developing the rural electrification of scattered populations, the power supply solution using photovoltaic kits seems a possible solution. Finally all isolated public or private infrastructures (health center, schools, hotels, telecommunications pylons, public lighting of roads) should be powered by solar energy as part of a vast program of decentralized electrification. These projects could involve private investment and public service delegation.

Thus, in this study is given a plan to follow in order to allow the Somalian population to have access to the electrical energy whatever the place where someone is on the soil of Somalia because the solar radiations reach all the national territory of Somalia from morning to night just at the same level.

### **3.2.4 Implementation Of The Solar Photovoltaic System In Somalia's Energy System**

Taking into account Somalia's vision for energy by 2020 and 2045 horizon responding to the Millennium of Development Goals, to be able to serve the largest number of people in electricity, considering the evolution of the number of electricity subscribers per center (Table 2.5), the evolution of electricity consumption by category of consumers (Table2.4 ) as well as on the basis of the forecast of the increase of the Somalian population by 2045 and beyond (Table2.1), an estimated inventory of the electrical load of all categories of

consumers registered in Somalia's electricity grid is made in order to be able to size photovoltaic power plants that could considerably reduce the lack of electricity that Somalia faces when added to the existing one.

Thus, for households, villages and neighborhoods, the forecast of electricity consumption in the next 10 years, 20 years, 30 years, etc. seems to be simple. Taking into account the data in the table of the projection of the evolution of the population, it is enough to make an estimated inventory of the needs in electrical energy for a household supposed to be modern and after to multiply by the estimated number of households which can constitute a village or a modern neighborhood. However, as the population continues to increase, it will be sufficient to increase energy production according to new villages and neighborhoods that will be created as electricity consumption of a village, modern neighborhood will be known.

**Table 3.1:** Estimated Daily Electrical Load Table for a Single Modern Household and a Modern Village.

NO.	Equipment	No. in use	Power(w)	Total Power	Hours/Day	Watt-hour/day
1	Lamps LED	12	5	60	6	360
2	Cell-Phones	3	5	15	3	45
3	Radios	1	10	10	8	80
4	Televisions	1	40	40	6	240
5	Refrigerators	1	75	75	20	1500
6	Iron	1	1000	1000	0.25	250
7	DVD Player	1	30	30	2	60
8	Water pumps	1	500	500	1	500
9	computer	1	100	100	3	300
10	Washing machine	1	2000	2000	0.25	500
Total						3835
No. of Households						100
Total for Households						383500

Based on these values, a typical daily load curve for an estimated single modern household responding to millennium development Goals in remote regions of Somalia with hourly resolution has been described. The estimated maximum

power consumption demand with respect to the obtained load profile, for the chosen single modern household is approximately equal to 3835Wh/day. Villages can, however, be established in the most remote areas of the national power grid to allow to everyone access to electricity regardless of the part of the country where we are. For the other categories of consumers, the forecast of electricity consumption also seems not to be complicated. The tables of the evolution of the electric consumption and the evolution of the number of the subscribers for the 10 years run give an idea on what will look like the consumption of electricity in the years to come. From there, an estimated electricity consumption projection inventory is made on the basis of these data presented in these tables mentioned

above. Subsequently, a summary table of electricity consumption forecast is released in order to make the sizing phase easy and possible.

**Table3.2:** Recapitulative table of estimated daily electricity consumption for all categories of subscribers of the Somalia energy system horizon 2023, 2032, 2041 (in GWh)

Consumer categories	2005	2014	2023	2032	2041
Government	4.3	6.1	7.9	11.5	18.7
Common and public lighting	0.5	1.3	2.1	3.7	6.9
Trade	12.0	33.7	55.4	98.8	185.6
Industries and Craft	1.6	33.3	65.0	128.4	255.2
Households	45.9	105.3	164.7	283.5	521.1
REGIDESO	1.0	4.9	8.8	16.6	32.2
International Organizations	2.5	1.2	1.0	2.0	1.5
State Corporations	1.0	10.6	20.2	39.4	77.8
Administration, personalized management	3.4	12.5	21.5	39.6	75.8

Religious confessions and social organizations	2.9	4.3	5.7	8.5	14.1
Prepaid sales	4.7	9.8	14.9	25.1	45.5
Total	79.8	223	345.7	617.9	1234.2

To meet at least the needs of different subscribers in electricity and to give access to electricity to as many Somalians as possible, an installed electrical power estimated at **200.7 GWh** could be implemented by 2023 while the estimated power of **500.4 GWh** could be installed for 2032. Going beyond, a nearby installed electrical power of **1300.2 GWh** could be implemented by 2045.

### 3.3 Sizing Of Photovoltaic System.

So that a work of establishment of a photovoltaic system can be done well and efficiently, it is obligatory to carry out a sizing of the system which means to fix the size, the optimal characteristics of each element of a system which the configuration is known.

Indeed; Considering the technical factors, sizing can eventually lead to any decisionmaking even changing the system, for example if it is noted that technically optimal

elements are very expensive or indispensable.

This sizing method consists in first determining the peak power that provides the electrical energy needed during the least sunny month. It's about determining when you need electricity, and measuring your consumption. This is a step that involves few calculations, but requires relatively much thought because an error at this stage will distort the results until the end.

The method has 7 steps: The result of a step directly influences the result of the following steps. If you get an aberrant result, it does not necessarily mean that you were wrong in your calculations. Do not hesitate to go back, especially in the first step, to redefine your needs (such as reduce your consumption by choosing more economical devices).

### 3.3.1 A Stand-Alone Photovoltaic System

Components of solar PV system

Solar PV system includes different components depended on your system type, site location and applications such as solar charge controller, inverter, battery bank, auxiliary energy sources and loads (appliances).

Major Components of PV System:

- PV Module or photovoltaic solar panel that can produce the required quantity electricity.
- MPPT Charge Controller or solar charge limiter that protects the batteries accumulators against overloads and deep discharges
- Battery Bank that store the energy produced by the panel solar photovoltaic.
- Accessories such as:
  - Cables that connect the components
  - Converter: it adapts the DC voltage delivered by the solar battery to the voltage receiver power if it is higher or lower.
  - Inverter: It transforms direct current (DC) into alternating current (AC)
- Loads are then the devices that use electricity: lamps, radios, televisions computers, pumps, refrigerators.

Thus, the process of sizing the photovoltaic system is done by the following steps:

Determine power consumption demands

During this stage we try to estimate the consumption of equipment supposed to be known with the aim of obtaining the average total consumption per day and per period (summer, winters, holidays),

The average total energy required each day  $E$  ( / ) is the sum of energy consumption of the various equipment constituting the system to be studied,



such as television, lighting lamps, electronic devices, etc. It is given by the following law [23].

With: **E** the total consumed energy

The summation of each item in installation.

The determination of the average time of use is more difficult and must take into account:

- The season,
- The number of occupants
- The mode of use

For equipment which is not used daily and for all high consumption equipment, start from the duration of the task's operating cycle. Thus, the consumption of each equipment can be calculated as follows [23]:

$$(Wh/ \text{ day}) = ( \text{ Power } \text{ Duration of use of each hour})/\text{Day} \quad (3.1)$$

### 3.3.2 The energy to be supplied to the inverter and its use

Figure: Example of solar inverter diagram

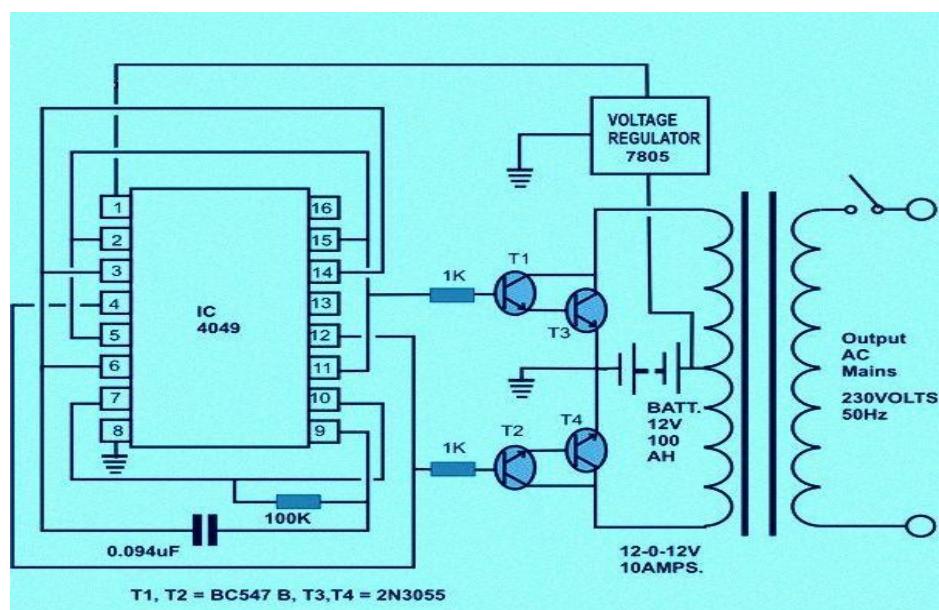

**Figure 3.3:** Example of solar inverter diagram

Consumption in 220V AC of small powers (television, radio, cell -phone...) that we note X;

Consumption in 220V AC of long duration or high power such as the fridge, that we note Y;

And possibly the lighting; energy rated W.

The actual efficiency, average of a well-designed inverter, of good quality, depends on its charge rate [23]

With  $P_{AC}$ ,  $P_{DC}$  respectively power output and power input.

If we assume that the inverter is well used: its charge rate must be high ( from 0.75 to 1).

The conversion yield is then 0.7 to 0.9 and we retain the average value of 0.8.

Thus, the power to be supplied to the inverter to dispose of the energy E at the output (at 220 V AC) is [24]:

The energy demanded from the inverter E is worth:

$$E=X+Y+W \quad (3.2)$$

Where E: The energy demanded from the inverter (Wh /day) X: The consumption of small power equipment in 220V AC. Y: The consumption of high power equipment in 220V AC. W: The lighting

And the energy to be supplied to the inverter is:

$$1.25* E=1.25*(X+Y+W) \quad (3.3)$$

### 3.3.3 The energy to be supplied to the battery and its use

The use of the battery is not at all reliable and causes some losses that are often due to:

Energy efficiency of the battery;

Self discharge, which depends on the storage duration (for a given battery)

For a so-called solar battery, means well suited to photovoltaic systems, energy efficiency is 0.80 to 0.85 and self-discharge of 3% per month.

The overall efficiency found in a habitat system is 0.8 in general [25], so:

$$E_B = E_P * 0.8 \quad (3.4)$$

Where:  $E_B$  the energy supplied by the battery  $E_P$  the energy supplied by the panel

The electrical energy supplied by the photovoltaic generator

The sunshine received and the orientation of the panel influences the content of the electrical energy supplied by the panel. The estimate of the solar energy received on the site is not at all complicated, but it is necessary to take into account the characteristics specific to the site of the installation itself [25]. Estimate of solar energy received at a given site This estimate must take into account both:

Statistical data on solar energy received on the installation region;

Specific characteristics of the site and likely to prevent the photovoltaic panel from receiving all the energy possible (due to masks, snow, dust ...).

### **3.3.4 Statistical values of solar energy**

It is necessary to know with as much accuracy as possible the solar energy received on average per day on the site during a given period. This period is generally equal to one month [25].

Depending on the country, for a given period; the quantities are determined from one of the following data (for a given period):

Average number of hours of sunshine per day (or sunstroke duration);

The average irradiation received on the ground (horizontal plane);

Overall sunlight on a plane inclined at a certain angle.

However, global sunlight on an inclined plane at a certain angle is by far the most interesting since it allows the angle to be easily tilted panels given, to determine the electrical energy produced by a given peak power panel.

### **3.3.5 Site specific characteristics**

Before taking any action to implement a solar energy site, it is too recommended and mandatory to know the characteristics of the site where you want to implement it.

The snow, the dust are likely to decrease during certain periods the solar energy received by the modules. A reduction coefficient must then be applied to the data defined in the previous paragraph to take into account the particular atmospheric conditions and system maintenance conditions (frequency of cleaning, etc.)[26].

The most important cause of reduction is the masks (tree, houses ...) shading all or part of the panel during part of the day each day, or during a certain period of the year (usually the winter) [26].

Estimation of the energy supplied by a photovoltaic panel

For a given angle of inclination of the photovoltaic panel, the series of amounts of solar energy received makes it possible to estimate the electrical energy supplied by the panel on average, per day, for each month.

So, to obtain the production of the photovoltaic module during a day, we will multiply the peak power of the panel by the equivalent number of hours of this day:[ 43]

$$E_{elec} = N_e \times P_{peak} \quad (3.5)$$

$E_{elec}$  : Electric energy produced during the day (Wh / day)  $N_e$ : Number of equivalent hours (h / day)

$P_{peak}$ : Peak power (W).

Unfortunately, this panel actually produces a much lower amount of electrical energy because:

The panel rarely works at its optimum operating point (unless a slave adaptive electronic device is used). In particular, a panel charging on a battery almost never works at its maximum power point (16 V for a 12 V battery, but variable with illumination).The diodes and the connections cause energy losses. Disparities between modules cause energy losses. The maximum power point also depends on the panel temperature.

During the year, the sunshine is not always the same. Some days or months are very sunny while others are not. The determination of installed peak power is of particular interest, given the cost of the watt-peak. Generally, the variation of

the energy provided by a photovoltaic panel of inclination given does not follow that of the energy needs of a dwelling.

If you set the peak power to best meet the needs of a given month, you usually get a deficit or a surplus for another month.

Over what period efforts should be made to match needs and inputs? An inclination equal to the latitude of the place makes it possible to capture a maximum amount of annual energy, but:

Some of this energy may be useless; energy is expensive to store.

The panel may be too expensive.

However, during winter times, means when the sun is low, a strong inclination closer to the vertical (latitude of the place for example  $+20^\circ$ ) favors the capture of solar energy.

### **3.3.6 Principles of sizing and positioning of the solar panel**

The objective of sizing and positioning the solar panel being able to maximize the capture of solar energy, it makes use of two extreme principles that illustrate the reasoning used to confront:

The energy the panel must provide.

The energy that the panel can provide from sunshine

#### **Sizing on the least sunny month**

A simple and safe solution is to choose a peak power such that during the least sunny month, the energy supplied by the panel satisfies the needs, with a slope close to the latitude of the place. This is the solution generally adopted by companies marketing and installing photovoltaic systems [27]. This solution unfortunately leads to a significant waste of energy during the other periods, and especially for the sunniest period.

To reduce these losses, and thus save on the peak power of the panel, it is possible:

Promote the exposure of the sign during the least sunny season by choosing an inclination greater than  $10$  to  $20^\circ$  ( $15^\circ$  in general) at the latitude of the site;

To oversize the battery by actual needs (mainly related to the possible number of sunless days during this less sunny season [28]); It is then possible to size not more on the month the sunny month, but on months a little sunnier to fill the month's deficit in the sunny month thanks to a sufficient capacity of the battery.

### **Sizing on the sunniest month**

The peak power is sufficient to meet the needs during the sunniest month and generally quite insufficient to meet winter needs. Such sizing involves the use of a complementary source of energy. In a two-source system, it is necessary to favor the use of solar energy during the sunnier months and therefore, choose a low inclination of the modules ( $\alpha = \text{latitude} - 10^\circ \text{ to } 20^\circ$ ). This dimensioning finds its limit in the cost of complementary energy [23].

A cost calculation (investment, operation) makes it possible to decide on the optimal solution between:

Small panel slightly inclined and complementary source very solicited.

Larger and more inclined panel and less solicited source.

### **Inter-seasonal storage of energy**

It is conceivable to better adapt the solar contributions to the needs by using in winter energy stored in battery during the sunny periods. It is conceivable to better adapt the solar contributions to the needs by using in winter energy stored in battery during the sunny periods.

The long-term storage (03 to 06 months) in battery and yet practically excluded because of its cost: the capacity of the necessary battery is too important. Furthermore: The charge of the battery is then delicate (it would be necessary to split the capacity or increase the current of the load). The panel cannot recharge the battery alone if the discharge is too deep. Self-discharge represents about 10% of the capacity in 3 months, that's to say that in average, about 10% of this large capacity is installed in pure loss. Sizing procedure of the solar panel Whatever the principle adopted, it is ultimately a question of ensuring the adequacy between the contributions and the needs for a given period (generally a given month), that is to say, comparing that the panel must

provide with tables that give the energy provided by a given power panel, according to various inclinations.

#### Choice of operating voltage

The availability of materials such as modules and receivers influences the choice of the rated voltage of a system. In addition, it depends on the power and energy levels required depending on the type of application.

**Table 3.3:.**The corresponding system voltages at each peak power interval.

Peak power (Wp )	< 500 Wp	500Wp - 2KWp	>2KWp
System voltage (V)	12 VDC	24 VDC	48 VDC

#### Sizing of the battery

This step consists in determining the storage capacity C of the battery in KWh then in Ah .The energy stock meets two needs, and the choice of capacity must also satisfy 4 constraints namely:

##### **3.3.6.1 Role of the energy stock**

Dealing with periods with insufficient sunlight: the stock can meet the needs despite the random amount of solar energy received; in particular, it ensures the continuity of service during periods without sun (of a certain length).

Make the best use of the solar panel: if it has not been sized in the least sunny month, the battery must fill a possible deficit during certain periods.

##### **3.3.6.2 The battery-appliances electrical connection**

###### DC distribution

The same calculation must be made for the section of the cable between the battery and the different devices to be powered.

It must take into account the design of the distribution: in the case of a single output of the battery, the devices are connected in parallel.

While in the case where the battery has several outputs (models that exist on the market), each of these outputs is connected to a device or series of devices. [6]

The total wiring is often longer, but the maximum current in each of the circuits is less, resulting in a smaller section, and ultimately a lower price.

Distribution from an inverter

From this stage, alternating current 220 V is distributed. The distribution is then quite conventional, which means that the rest of the distribution process can be assimilated to other forms of distribution of the electric current, for example the processes used in the distribution of hydroelectricity

### **3.3.7 Method Of Designing And Sizing Large PV Plants**

For very large photovoltaic plants, a big difference can be seen in relation to the small individual photovoltaic plants mentioned above. For small photovoltaic plants, all the electrical energy produced is consumed at the same place of production, which is not the case for very large photovoltaic power plants whose electrical energy is supposed to take long distances to the places of consumption. The large photovoltaic plants are supposed to produce huge amounts of energy which are then injected into the electrical networks.

As for small photovoltaic plants, the implementation of very large photovoltaic plants requires a feasibility study and this time a study too deep than that made for small photovoltaic plant due to the components as huge and rigorous as for the previous cases. However, the steps of the reasoning remain almost the same in terms of sizing except that here we have to deal with huge quantities of components, namely the high number of solar panels, batteries, inverters, regulators, controllers; to name just that. When the PV generation is in excess of the real time local demand, the excess power is stored in batteries; if the batteries are also fully charged, the excess power is fed to the utility grid through a grid-connected inverter.

It should be noted that the largest photovoltaic installations can reduce the cost of the photovoltaic installation per watt of rated power installed [30 ] and that large-scale PV plants are composed of several thousands of PV panels, each being in the range of 150–350 W. The optimal values of the PV plant location, size, and time of investment, which comprise the optimization problem decision variables, are calculated such that the net present value of the investor's profit is maximized [30].



The financial analysis of a large-scale PV plant is performed by calculating the expected power generation of the PV plant using an appropriate model of the PV modules and considering the capital investment cost, the annual operating and maintenance costs, and the performance derating factor of the PV system. Also, the internal rate of return and payback time period are used as metrics in order to explore the profitability of the PV installation.

However, both the cost of energy losses due to transformer overloads and efficiency, and the capital and lifetime operating costs of the transformer are considered during the design process. The impact of energy losses due to grid instability is also taken into account.

The effects of partial shading, PV module mismatch, cable losses, and power converter efficiency are also quantified in order to obtain the energy yield of the PV plant for each of the architectures under study.

Therefore, more sophisticated architectures have been developed where PV modules are arranged in strings, or even substrings, each one connected to the step-up transformer through a dedicated inverter, or a dedicated DC/DC converter and a centralized inverter. Conventional distribution transformers are widely used, either singly or paralleled, to connect the inverter to the main power line. The step-up transformer is a key element of a PV system, as it processes the whole generated energy.

Moreover, not only the efficiency and the cost are of primary concern, but also the influence of the transformer size either on the amount of energy delivered to the main utility, either on the stability of the network

In fact, while selecting a transformer rated power close to the PV plant peak power makes theoretically possible to fully transfer the captured solar energy to the utility network, such a design criterion will in practice lead to oversize both the transformer, the inverter and the power line. Moreover, a too large transformer would operate for long times at a reduced efficiency, while generating a largely unpredictable power injection on the main grid [6-9]. The last may lead to grid instabilities, causing frequent plant shutdowns, and requiring a remarkable reserve power to be provided by conventional

generators. On the other hand, a too small step-up transformer would constitute a bottleneck, preventing an optimal exploitation of the solar energy.

Determination of the number of batteries for a photovoltaic solar power plant

For a solar photovoltaic installation, the use of batteries is an obligation. Indeed, to make electricity available every moment even during the night or when the sun is sailed, there must be a system of storage of the energy produced and this is possible thanks to the batteries. The objective being to be optimal in the production of the electrical energy, the number of batteries to be used must be determined on the basis of calculations.

Before you start:

The energy that the installation will consume each day must be known.

Know at least the voltage (usually 12V) and the capacity (often 50, 100 or 200Ah) of the batteries you will use. You can also do the math with several types of batteries and choose the most economical solution.

### **3.4 Application**

As we have already determined, so that households have the living standards that meet the Millennium Development Goals, a daily energy consumption of a modern neighborhood should be 383500 watts-hour/day.

The following example of a photovoltaic power station can be used to provide electricity in about 8 neighborhoods with 100 modern households each one .

Suppose we want to implement a photovoltaic plant that provides 3MWh / day and we choose to use 24V batteries of 200Ah capacity.

#### **3.4.1 Determination of the desired autonomy**

The storage capacity needed depends essentially on 2 parameters: the energy consumed per day and the autonomy of the system, that is to say the number of days that it will be able to support without sun. Autonomy generally varies between 3 and 15 days.

The number chosen depends on two factors:

- Weather conditions in the region where you are: are there periods of prolonged bad weather? If so, how many days can it last?
- The reliability you want for your system: Do you accept that power can be cut? If so after how many days without sun?

However, given the maximum depth of discharge of the batteries, the batteries must not be deeply discharged to allow them to have a longer life: It is necessary to set a maximum depth of discharge. In general this depth varies from 30 to 80%. A good intermediate value is 50%, that is, you will only use half the capacity of your batteries.

For this example we are dealing with, the capacity of your batteries should therefore be:

$$C_B = E_R / \text{Max}_{dd}$$

Where:  $C_B$  is the capacity of the battery  $E_R$  is the energy to be returned.

$\text{Max}_{dd}$  is the maximum depth of discharge

For our installation we take a maximum depth of discharge of 50%, the capacity of the batteries must therefore be:

$$W / = 6.872 W$$

### 3.4.2 Deduce the number of batteries

To change from a number in  $W$  to a number of batteries, multiply by 1000000 (to convert  $W$  to ) divide by the voltage at the battery terminals (to convert the  $W$  to Ah) then by the capacity of the batteries (in Ah) and round up to the next digit.

### 3.4.3 Calculating total Watt-hours per day needed from the PV modules

After carefully calculating the electrical energy consumed by each device connected to the system, calculating the total number of watt hours requested from the photovoltaic modules becomes simple. Simply add up the total energy consumption of each device connected to the system without forgetting to add all the probable losses.

The formula for calculating

$$= \sum E * 1.3L_t \equiv \sum (P * t) * 1.3L_t \quad (3.25)$$

Where: is a total watt hour from the photovoltaic modules

$\sum E$  is the sum of the amount of energy consumed by each device in the system

$L_t$  is the total losses that could happen in the system installations

$t$  is working time per day. Sizing of the PV modules

Photovoltaic modules produce different amounts of power depending on whether their size and the material from which they are manufactured differ. Indeed, before pretending to know the sizing of the photovoltaic module, the determination of the total requirements in watt peak to be produced is an obligation. However, the power peak ( $W_p$ ) produced is considerably influenced by the size of the photovoltaic module as well as the climate of the photovoltaic plant's location.

For this, given the variation of the climate and the location of the photovoltaic site concerned, we must consider the "panel generation factor" which is different in each site to reduce the risk of being wrong. It should be noted that this panel generation factor of the photovoltaic module is determined experimentally according to the region concerned. For example, the panel generation factor for Thailand is 3.43.

To determine the sizing of PV modules we may proceed as follows :

Calculating of the total Watt-peak rating needed for PV modules During this step, the total peak power required for the PV panels must be determined to ensure the operation of the devices. To do this, simply divide the total daily peak power of the site (watts-peak / day) by the generation factor of the photovoltaic panels (add mathematical equatio

Where: is the Rated Peak Power, is the daily peak power (watts-peak/day) and  $V$  the generation factor of the photovoltaic panels

Calculating of the number of PV panels for the system

A block diagram of the large PV plant that is considered in the proposed optimization process is illustrated in Fig. 1. The PV modules are distributed in multiple PV inverters, and the generated power is injected into the electric grid at the point of common coupling (PCC) through an interconnection (i/c)

transformer and cable, respectively. The total number of PV modules which must be installed in the PV plant is calculated according to the PV plant power rating  $P_{\text{plant, nom}}$  (MW<sub>p</sub>) that is specified by the PV plant designer, as follows:

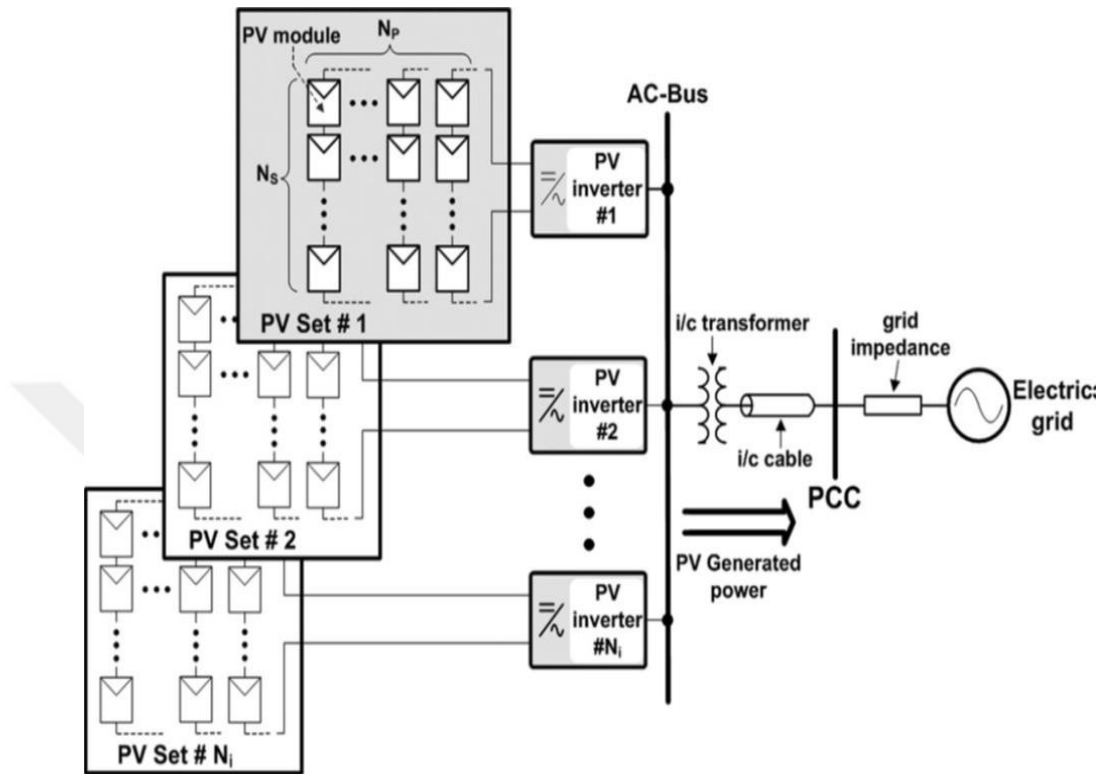

**Figure 3.4:** Block diagram of the large PV plant [31].

### 3.5 Transmission And Distribution Of Electrical Energy

After the operations of estimating the electrical energy to be produced in a photovoltaic power plant, after having minutely sized and implanted it, it is the time to transmit and distribute the electrical energy which, sometimes, must make long distances to reach the places of use. However, the types of electric transmission lines and the amount of electrical energy they transmit are determined according to the distance to be traveled.

During the transmission of electrical energy, the efficiency is better when this transmission is at high voltages. The greater the distance to which the electrical energy must be sent, the higher the electrical voltage in the transmission lines.

The use of these high voltages is linked to an economic objective. Indeed for a given power, the Joule line losses are inversely proportional to the square of the voltage

With:  $U$  = network voltage

$K$  = a constant function of the line.

In addition, the powers transported are such that the use of a low voltage would result in completely inadmissible cable sections.

Also, by taking into account the mathematical formulas of power as a function of voltage, current and resistance, we can admit the following statements:

We also note that during the transmission of electrical energy, the electrical current does not interest us; we focus on the voltage which must be raised according to the distance to travel in order to maximize the efficiency of the transmission line.

The use of high voltages is therefore imposed despite the isolation constraints that translate into higher hardware costs, the easiest solution being the use of overhead lines.

In any case, the choice of a transport voltage is above all a technical-economic compromise, depending on the powers to be transported and the distances to be covered.

The line losses are mainly due to the Joule effect, which depends only on two parameters: the resistance and the intensity of the current  $I$

The use of the high voltage makes it possible, with equivalent transmitted power ( $P = U.I$ ), to reduce the current and therefore the losses.

Moreover, to reduce the resistance, at industrial frequencies, there are only two factors, the resistivity of the materials used to manufacture the transmission cables, and the section of these cables. For material of manufacture and equivalent section, the losses are therefore equal, in principle, for overhead lines and for underground lines [33].

Generally, the height of the pylons on which the electric cables of High - Voltage Line are suspended depends on the voltage to be transmitted. The more

we have the voltage of the high line, the more we have the pylons which are high. A pylon supporting a line of 400 000 V can reach 90 m high [33].

However, the electrical energy is not used as it is transmitted at very high voltages. It must be lowered to be adapted to the different electrical appliances and machines that use it at low voltage (most often 220 -380V).

It should be noted that this operation of raising or lowering the electrical energy to obtain very high voltages, high voltages, averages or low voltage is possible thanks to the elevating or lowering transformers of the electrical energy.

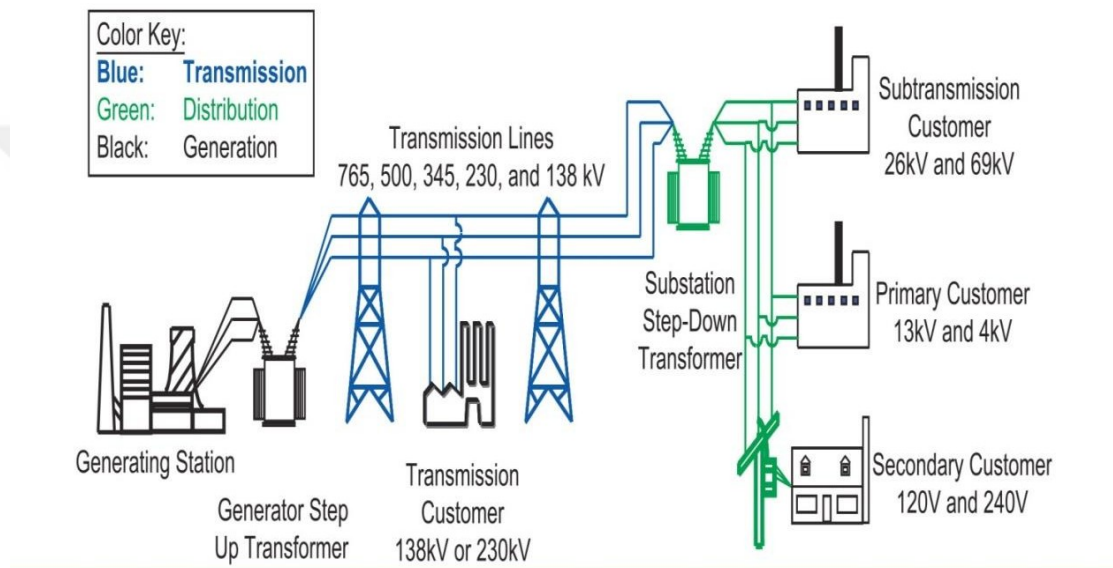

**Figure 3.5:** Schematic diagram of the electricity production and transmission network Grid.

In the example above, thanks to the Generator Step Up Transformer, the electrical energy produced is stepped up to high electrical voltages before traveling the distances to the various locations where it will be used. The electrical voltages in the transmission lines in the same example vary from 765, 500, 345, and 230 to 138kV. Afterwards, the procedure consists of serving all the customers in their different localities. However, the electrical energy transits very high voltage lines to the low voltage ones thanks to Substation Step-Down Transformers. This step is the electrical distribution where customers receive electrical energy that they use according to their needs.





#### **4. PROBLEM CLASSIFICATION**

Most of MCDA applications with discrete choices in the vitality segment centers around complex erratic choices of vital significance. So also to MOP issues, the power part shows up as an immense wellspring of motivation. Be that as it may, there is a reasonable contrast between the two strategies with respect to both choice setting and means utilized. MOP definitions speak to in incredible detail the genuine framework's structure so as to set up the utility's medium-to long haul plans. In spite of this reality, displaying impediments by and large confine the scope of effects that can be coordinated in the assessment technique. In actuality, definitions with discrete options (all in all, expressly known from the earlier) are regularly attempting to deal with not well organized issues while having the option to look in more detail at all the various angles that ought to be considered so as to recognize vital and approach headings to direct future activities. Moreover, there is an incredible assortment of choice issues that can be managed this sort of displaying approaches.

Comparative choice settings are practically identical with the choice among the arrangement of productive arrangements controlled by MOP details. In the power division, significant key choices concern the decision among elective techniques at a nation or local level by considering various situations for the presumable advancement of outside conditions [31, 17, 19]. Also, situations that have been figured by the particular qualities of the self-ruling power arrangement of the island of Crete are assessed as for a huge arrangement of maintainability criteria in [34]. At long last, in [61] arrangement choices are seen as made out of a lot of predictable activities and the aim was to build up a system to assist utility administrators with formulating choices, to express inclinations and to discover the approach alternative verifying the most tasteful accomplishment of their vital objectives. The proposed organizing and scientific method has been represented with a contextual analysis alluding to the determination of the most suitable power evaluating arrangement.

Other than the power division, a similar thinking is pursued for the determination among discrete approaches and activity plans for the entire vitality framework. [65] and [57] address the more extensive subject of vitality arrangement at the national level by organizing and formalizing the entire choice method with the dynamic contribution of a few intrigue gatherings. In [35] elective designs for the advancement of sustainable power sources in Greece are developed and assessed by a gathering of partners so as to recognize a trade off arrangement offering spot to the largest conceivable accord.

At an a lot littler scale, decision issues are looked in the choice of the best choice among various fundamentally unrelated elective plans abusing to an alternate degree and in an alternate manner a specific vitality asset, particularly a privately bound sustainable power source asset.

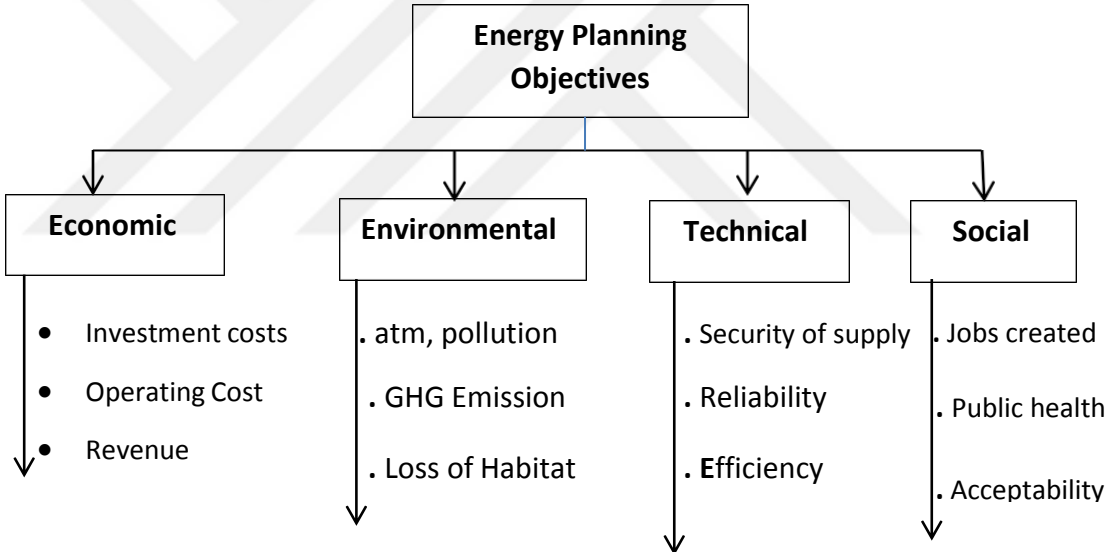

**Figure 4.1:** Common place various leveled structure of criteria utilized in vitality arranging.

**4.1 Internal and External Uncertainties.**

Defenselessness is a crucial typical for this present reality that rises up out of the reliably extending multifaceted nature of structures and the capriciousness of system. In face of this astounding world, it is normally hard for the manager to get all the flighty miracles, to move past all the noteworthy data and, to wrap things up, to express their value choices.

Essentialness masterminding is by its very nature a convoluted task stressed over complex mechanical structures interfacing from various perspectives - not all being through and through analyzed and appreciated with the money related, normal and social condition.

Additionally, essentialness masterminding is by definition centering at a basically far away future, for which measures for explicit points of view are especially difficult to make, in light of missing information, of the stochastic thought of the variables worried (for instance inflows into a hydro store) or of a nonattendance of human involvement as for specific wonders (for instance nursery sway). To this reason, different pivotal procedures are executed in imperativeness organizing applications, stretching out from fundamental circumstances and affectability assessment to progressively propelled philosophies reliant on the abuse of cushy sets, stochastic strategies, etc. We will take a gander at the kind of vulnerabilities perceived in the reported composition and the way in which they are treated by perceiving inside and external vulnerabilities as portrayed in [10].

#### **4.2 Shareholders Involvement.**

Imperativeness masterminding is even routinely thinking the strong excitement of the general populace and of a couple of pros and non-administrative affiliations. This is mainly a direct result of the creating environmental stress over the certified impacts related with imperativeness creation and use. Moreover, the complex mechanical points of view, the high capital expense and the long lifetime of the key undertakings make the trading of applicable bosses and apt specialists a basic segment of the decision methodology. Along these lines, a couple on-screen characters are by definition related with the masterminding strategy and others are basically wishing to viably check out decisions they accept they may impact their very own welfare or the world's general quality.

In all honesty, MCDA uses in criticalness getting sorted out are in their common part portrayed by a brilliant thought of a typically enormous and interdisciplinary party of accessories. This model is clearly recognizable in the organization, regardless of how their brisk interest isn't ceaselessly developed.

Two or three reasons are spoken to, while others are continuously hard to be yielded. Among the last referenced, possibly the most critical is that such a participatory strategy for sharing concerns, trading examinations, and suffering arrangements is so far not astoundingly basic in people when all is said in done or private area. Furthermore, it is a costly and dull methodology. Thusly, in specific preparations no piece of information is made on an accomplices' venture, though some sort of gathering with

may have happened at an earlier period of the assessment. In another social occasion of creations this consideration is decreased to an easygoing and thusly not limiting technique which takes one of the two after structures:

#### **4.3 Concentration of the Outside Environment.**

All of these advantages must be moved, readied and a portion of the time in like manner set away in different regions and structures before changed over to end customer essentialness like power and warmth. Hence we consider three exceptional sorts of system parts:

- Conversion: for change of one imperativeness transporter into another at a specific geographic region;
- •Transport: for transportation of a given imperativeness transporter over a portrayed geographic partition;
- •Storage: for limit of one imperativeness transporter at a given time.

On the left 50% of the drawing, the customers are addressed by their full scale enthusiasm for different sorts of end-use essentialness: for instance from the hard and fast imperativeness need, x % can be for gas, y % is for power, z % is for warmth and bubbling water. From now on, the boss should in like manner have the choice to approach trustworthy data as for the structure of the total essentialness demand which will be thought about when orchestrating the system.

## 4.4 A framework for including MCDM and uncertainty in the decision making process

### 4.4.1 The basics of a new decision support tool

In the second part we recorded the primary viewpoints identified with the procedure of basic leadership in the nearby vitality frameworks arranging. In Figure 5 [based on Matos and Pinho de Sousa, 03] we schematically speak to a proposition on the best way to consolidate different criteria and vulnerabilities inside customary advancement techniques so as to take care of the arranging issue.

In the pre-enhancement stage, the leader will contribute in issue detailing and vulnerability portrayal. This should be possible in a few stages:

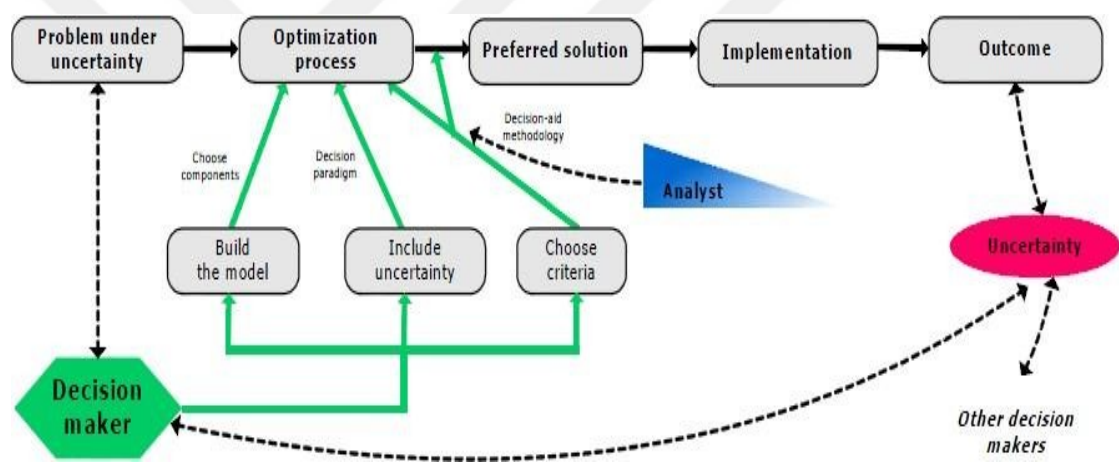

**Figure 4.2:** Framework for including multiple criteria and risk into the decision process

1) At the start, the leader ought to have the option to determine the framework he needs to investigate and a few potential speculation options. The most straightforward approach to do that is by basically *'drawing'* the framework as a system with all vitality sources and request focuses included. The graphical UI of the choice help apparatus will give the client a whole library of segments to look over. The system portrayal of the vitality framework is all the time utilized in vitality arranging issues [51]. To epitomize this, a civil vitality framework model with elective answers for fulfill an enhanced vitality need can be spoken to as in Figure 5. A few accessible vitality assets (that can be gas, biomass, squander, and so on.) are drawn on the left in the figure.

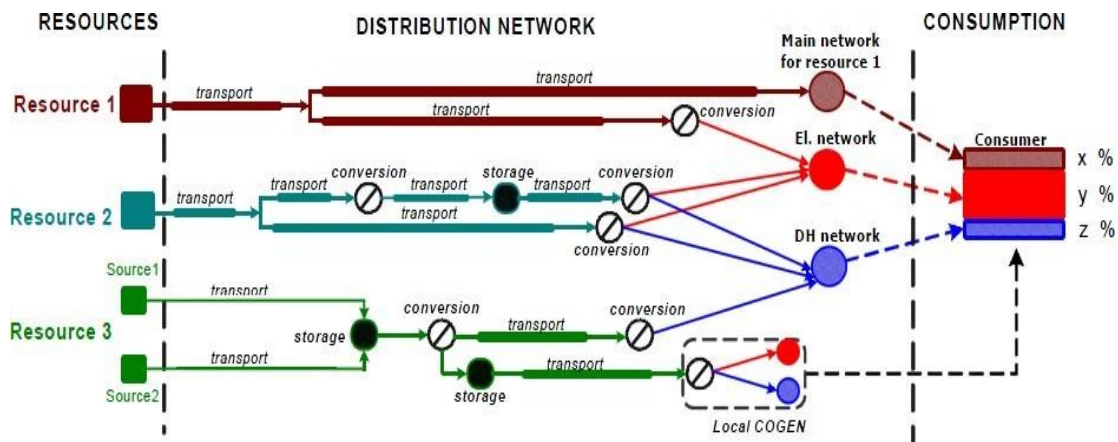

**Figure 4.3:** Example of a simplified local energy system model.

All of these advantages must be moved, readied and a portion of the time in like manner set away in different regions and structures before changed over to end customer essentialness like power and warmth. Hence we consider three exceptional sorts of system parts:

- • Conversion: for change of one imperativeness transporter into another at a specific geographic region;
- •Transport: for transportation of a given imperativeness transporter over a portrayed geographic partition;
- •Storage: for limit of one imperativeness transporter at a given time.

On the left 50% of the drawing, the customers are addressed by their full scale enthusiasm for different sorts of end-use essentialness: for instance from the hard and fast imperativeness need, x % can be for gas, y % is for power, z % is for warmth and bubbling water. From now on, the boss should in like manner have the choice to approach trustworthy data as for the structure of the total essentialness demand which will be thought about when orchestrating the system.2) In the consequent development, the boss should have the alternative to figure out which kind of vulnerabilities he needs to consolidate into the examination. Most boss may probably need to consider different worth assessments for different imperativeness resources and transporters in different markets (spot costs for power, publicize cost for gas and oil, etc). In like manner, in numerous examinations it will moreover be critical to consider the powerlessness in essentialness demand. Particular decision perfect models (foreseen worth, minimax, etc.) can be in like manner given inside the decision

help mechanical assembly, with the objective that each customer will more likely than not express his outlook towards peril.3)The last advance, as demonstrated by Figure 5, is the selection of criteria. We expect that our fundamental initiative mechanical assembly will be used by different boss, with different tendencies concerning the criteria. Since the decision issue will be assorted for different pioneers, we target giving an anticipated course of action of criteria that the boss can investigate when using the gadget. A better than average fundamental administration strategy should assist the boss with comprehending his criteria and on occasion to incorporate or crash some of them during the assessment [Henig and Buchanan, 96]. The boss should similarly be the one that decides the significant data and along these lines sway the tally of the attributes contrasting with different criteria.

Dependent upon the amount of criteria picked by the pioneer and on the size of the improvement masterminding issue, the intervention of a specialist will in all probability be relied upon to enable the fundamental administration to process. At the end, when the central terminations his responsibility, the rest will generally be improvement plan. A favored game plan will finally be gotten and recommended for execution.

The decision help gadget should be anything other than hard to use. Hereafter, the boss should have the alternative to grasp and accept the game plans obtained and besides to perform unmistakable affectability examinations that will provoke a predominant understanding of his essential authority process. As analyzed in one of the principle parts, we target working up a mechanical assembly that will be used by one pioneer immediately.

#### **4.5 4.5Dominating Approaches.**

Ruling procedures have known an astoundingly quick improvement and a sweeping use in a few utilization fields. Among these fields, centrality and normal masterminding have a conspicuous spot, on a very basic level in light of the manner in which that the imprecision related with the estimation and evaluation of regular parameters calls for exhibiting approaches giving progressively vital chance to the manager to express their waverings.

The ELECTRE get-together of frameworks made by Roy and his accessories at the LAMSADE Laboratory of the Paris Dauphine University [55] presents the higher repeat of use in the methodology of appearances examined, with ELECTRE III being the most ordinarily used. ELECTRE-TRI is used in [36, 59] in issues including as a concealed advancement the technique of the analyzed choices in referenced social gatherings of tendency. The PROMETHEE structure made by [16] at the Free University of Brussels is the other most all around related outranking method in all kind of employments, among which centrality sorting out issues. The point of confinement of passing on incomparable rankings is a giant reason supporting the utilization of PROMETHEE, together with the differing perceptible characteristics of the outranking approaches [39, 47]. In [35] the PROMETHEE exhibiting approach is picked a choice as simpler and insightfully direct by the included collaborators. A joining of ELECTRE III and PROMETHEE is proposed in [37] to draw favored position of their specific stand-separated properties, explicitly the use of veto edges and the capacity to turn out with complete rankings. Finally, happy with outranking systems are proposed in [41] to fit in with the immovable nonappearance of quantitative information. The usage of outranking perspectives is commonly magnificent in applications where the partners' solidification is considered as a focal bit of the crucial action strategy [6, 34, 35, 37, 47]. In these cases, nonappearance of thought and penchant edges are progressively profitable to get an unprecedented bit of the partners' inconsistency, while the between establishment express information required is given as parts of relative criticalness through basically less referencing showing moves close. In any case, it is incredibly the genuinely optional way by which motivations behind restraint are depicted that is the most sketchy piece of outranking approaches..

#### **4.6 Selecting suitable renewable energy in Somalia using Promethee method.**

In this section we study the possibility of using the PROMETHEE method when choosing multi-junction Renewable energy resources. the PROMETHEE (Preference Ranking Organization Method for Enrichment Evaluation) method is one of methods the most frequently used in order to fundament multicriterial



decisions ,I preferred to use this method since it is the best suitable method to solve while we have different alternatives and criteria.

#### **4.6.1 Steps of the PROMETHEE method**

In order to apply the PROMETHEE method, the following steps must be complied with:

**Step 1** Determine the criteria (  $j = 1, \dots, k$ ) and the set of possible alternatives in a decision problem.

Determine the weight  $w_j$  of the criteria. It shows the relative importance of each of the criteria and notes that.

$$\sum_{j=0}^k W_j = 1 \quad (4.1)$$

**Table 4.2:** five point linkert scale and its description

Scale	Weight of Importance
1	Unimportant
2	Less important
3	Moderate important
4	Important
5	Very important

**Step 3** Normalize the decision matrix to range 0–1 by

Using

$$R_{ij} = \frac{[X_{ij} - \min(X_{ij})]}{[\max(X_{ij}) - \min(X_{ij})]} \quad (4.2)$$

where  $X_{ij}$  is evaluation values provided by decision makers

$i = 1, \dots, n$ , and numbers of criteria  $j = 1, \dots, m$ .

**Step 4** Determination of deviation by pairwise comparison.

$$D_j(a,b) = g_j(a) - g_j(b) \quad (4.3)$$

$d_j(a, b)$  denotes the difference between the evaluations

of  $a$  and  $b$  on each criterion.

**Step 5** Define the preference function  $P_j(a, b) = F_j[d_j(a,b)]$ , where  $P_j(a, b)$  represent the function of the difference between the evaluations of alternative  $a$  regarding alternative  $b$  on each criterion into a degree ranging from 0 to 1.

**Step 6** Determine the Aggregated preference function.

$$\pi(a, b) = \frac{[\sum_{j=1}^n W_j P_j(a, b)]}{[\sum_{j=0}^k W_j = 1]} \quad (4.4)$$

**Step 7** Obtain the preference order In this step, ranking can be made either partially or completely. Partial ranking can be obtained using PROMETHEEII,

and in case complete ranking is needed, then the computation must proceed to one more step in PROMETHEE

II.

Positive outranking

$$\varphi^+ = \frac{1}{n-1} \sum_{b=1}^n \pi(a, b) \quad (4.5)$$

Negative outranking

$$\varphi^- = \frac{1}{n-1} \sum_{b=1}^n \pi(a, b) \quad (4.6)$$

The alternative with a higher value of  $\varphi^+$  and the lower value of  $\varphi^-$  is the best alternative.

#### 4.6.2 Numerical Application

In this study we will we have four alternatives Solar energy, Wind energy, Hydroelectric power, Biomass Energy, and four criteria Technical, Economic, Environmental and Social aspects. Let us consider A as an alternative and C as criteria and Csb as subcriteria. A1 as solar energy, A2 as wind energy, A3 as Hydro electric power, A4 biomass energy. The criteria we use to select are the subcriteria Sc 1 potentiality, Sc 2 efficiency, Sc3 investment cost, Sc4 Social aspect. The numeric values I have used here are taken from the literature, renewable energy potential in Somalia [65,66], renewable energy efficiency [67], investment cost [67], social aspect by using four point Likert scale where 1 is the worst and 4 is the best [67].

To determine which energy source has highest ranking in Somalia according to above mentioned criteria and by using data from the literature we will take following steps.

**Table 4.3:** Alternatives and criteria

Alternative	Criteria			
	Sc1	Sc2	Sc3	Sc4
A1	200	15%	3,837	4
A2	45	45%	2,213	3

A3	120	90%	2,936	2
A4	5	80%	8,180	4

### Step 1

Determine the criteria weight

In here we will consider how important with criteria x compared to criteria y with respect to the goal.

**Table 4.4:** five point linkert scale and its description.

Scale	Weight of Importance
1	Unimportant
2	Less important
3	Moderate important
4	Important
5	Very important

½, 1/3,1/4,1/5 value for inverse comparison.

### 4.6.3 pairwise comapison matrix

**Table 4.5** Calculating the sum of the matrix table

	Sc1	Sc2	Sc3	Sc4
Sc1	1	2	4	2
Sc2	0.5	1	5	2
Sc3	0.25	0.5	1	2
Sc4	0.5	0.5	0.5	1
SUM	2.25	4	10.5	7

Normalazing the table by dividing each column by its submissions we get.

**Table 4.6:** Normazlied Matrix

Sc1	Sc2	Sc3	Sc4	Criteria weight
-----	-----	-----	-----	-----------------

Sc1	0.44	0.5	0.38	0.286	0.4015
Sc2	0.22	0.25	0.476	0.286	0.308
Sc3	0.22	0.125	0.095	0.286	0.154
Sc4	0.22	0.125	0.0476	0.143	0.1339

#### 4.6.4 normalized pairwise comparison matrix

Step2

Normalize the matrix to range by using formula 4.2

$R_{ij} = [X_{ij} - \text{Min}(X_{ij})] / [\text{max}(X_{ij}) - \text{min}(X_{ij})]$  beneficial criteria , $R_{ij} = [\text{max}(X_{ij}) - X_{ij}] / [\text{max}(X_{ij}) - \text{min}(X_{ij})]$  Non beneficial criteria in this paper investment cost is non benifial criteria.

**Table 4.7:** Normalizing value table

Alternative	Criteria			
	Sc1	Sc2	Sc3	Sc4
A1	200	0.15	3,837	4
A2	45	0.45	2,213	3
A3	120	0.90	2,936	2
A4	5	0.80	8,180	4
Max(ij) (4,2)	(200,5 )		(0.9,0.15)	(8180,2213)
Min(ij)				

#### Table 4.6.5 Normalizing

**Table 4.8:** Normalizing value table

Alternative	Criteria			
	Sc1	Sc2	Sc3	Sc4
A1	$[200-5] / [200-5]$	$[0.15-0.15] / [0.9-0.15]$	$[8180-3837] / [5967]$	$[4-2] / [2]$
A2	$[45-5] / [200-5]$	$[0.45-.15] / [0.9-0.15]$	$[8180-2213] / [5967]$	$[3-2] / [2]$

	[200-5]	[0.9-0.15]	[5967]	
A3	[120-5] / [200-5]	[0.9-0.15] / [0.9-0.15]	[8180-2936] / [5967]	[2-2] / [2]
A4	[5-5] / [200-5]	[0.8-0.15] / [0.9-0.15]	[8180-8180] / [5967]	[4-2] / [2]
Max(ij), Min(ij) (4,2)	(200,5 )		(0.9,0.15)	(8180,2213)

**Table 4.9:** Normalized values

Alternative	Criteria			
	Sc1	Sc2	Sc3	Sc4
A1	1	0	0.728	1
A2	0.2051	0.4	1	0.5
A3	0.589	1	0.879	0
A4	0	0.867	0	1

### Step 3

Determination of deviation by pairwise comparison by using formula 4.3

**Table 4.10:** Deviation by pairwise comparison

D	Sc1	Sc2	Sc3	Sc4
D(A1-A2)	0.795	-0.4	-0.272	0.5
D(A1-A3)	0.411	-1	-0.151	1
D(A1-A4)	1	-0.867	0.728	0
D(A2-A1)	0.749	0.4	0.272	-0.5
D(A2-A3)	- 0.388	-0.6	0.121	0.5
D(A2-A4)	0.205	-0.467	1	-0.5

D(A3-A1)	-0.411	1	0.151	-1
D(A3-A2)	0.3839	0.6	-0.121	-0.5
D(A3-A4)	0.589	0.133	0.879	-1
D(A4-A1)	-1	0.867	-0.728	0
D(A4-A2)	-0.205	0.467	-1	0.5
D(A4-A3)	-0.589	-0.133	-0.879	1

Step4

Calculate the preference function

$P_j(a,b)=0$  if  $D(Ma-Mb) \leq 0$

$P_j(a,b)=(Raj-Rbj)$  if  $D(Ma-Mb)>0$

By applying, the following table is obtained

**Table 4.11:** Calculate the preference function

Pj	Sc1	Sc2	Sc3	Sc4
P(A1-A2)	0.795	0	0	0.5
P(A1-A3)	0.411	0	0	1
P(A1-A4)	1	0	0.728	0
P(A2-A1)	0.749	0.4	0.272	0
P(A2-A3)	0	0	0.121	0.5
P(A2-A4)	0.205	0	1	0
P(A3-A1)	0	1	0.151	0
P(A3-A2)	0.3839	0.6	0	0
P(A3-A4)	0.589	0.133	0.879	0
P(A4-A1)	0	0.867	0	0
P(A4-A2)	0	0.467	0	0.5
P(A4-A3)	0	0	0	1

Step 5

Calculate aggregated preference function

$$\pi(a, b) = \frac{[\sum_{j=1}^n W_j P_j(a, b)]}{[\sum_{j=0}^k W_j = 1]}$$

**Table 4.12:** Calculate the aggregated preference function

Criteria weight	W1	W2	W3	W4
-----------------	----	----	----	----

P	0.4015	0.308	0.154	0.1339	$\sum_{j=1}^n W_j P_j(a, b)$
P(A1-A2)	0.795	0	0	0.5	0.3857
P(A1-A3)	0.411	0	0	1	0.2989
P(A1-A4)	1	0	0.728	0	0.5136
P(A2-A1)	0.749	0.4	0.272	0	0.4658
P(A2-A3)	0	0	0.121	0.5	0.0856
P(A2-A4)	0.205	0	1	0	0.2363
P(A3-A1)	0	1	0.151	0	0.3312
P(A3-A2)	0.3839	0.6	0	0	0.339
P(A3-A4)	0.589	0.133	0.879	0	0.4128
P(A4-A1)	0	0.867	0	0	0.2670
P(A4-A2)	0	0.467	0	0.5	0.2108
P(A4-A3)	0	0	0	1	0.1339

In this study

$$\sum_{j=0}^k W_j = 1$$

**Table 4.13:** Aggregated preference function table

P	$\sum_{j=1}^n W_j P_j(a, b)$
Wj*P(A1-A2)	0.3857
Wj*P(A1-A3)	0.2989
Wj*P(A1-A4)	0.5136
Wj*P(A2-A1)	0.4658
Wj*P(A2-A3)	0.0856
Wj*P(A2-A4)	0.2363
Wj*P(A3-A1)	0.3312
Wj*P(A3-A2)	0.339
Wj*P(A3-A4)	0.4128
Wj*P(A4-A1)	0.2670
Wj*P(A4-A2)	0.2108
Wj*P(A4-A3)	0.1339

Step6

Determine the leaving and entering outranking flows .



Positive outranking

Submission of the columns divide by  $\varphi^+(a) = \frac{1}{n-1} \sum_{b=1}^n \pi(a,b)$

Negative outranking

Submission of rows divide by 3

$$\varphi^-(a) = \frac{1}{n-1} \sum_{b=1}^n \pi(a,b)$$

in here N is 3 the positive



**Table 4.14:** Leaving and entering outranking flows

Aggregated preference function	A1	A2	A3	A4	$\Phi^-$
A1	-	0.3857	0.2989	0.5136	0.3994
A2	0.4658	-	0.0856	0.2363	0.2626
A3	0.3312	0.339	-	0.4128	0.3610
A4	0.2670	0.2108	0.1339	-	0.2039
$\Phi^+$	0.3557	0.3118	0.1728	0.3876	

Step 8

Calculate the net outranking flow for each alternative  $\Phi(a)$

$$\Phi(a) = [\Phi^+(a)] - [\Phi^-(a)]$$

**Table 4.15:** Net Outranking Flow

Alternatives	$\Phi^+(a)$	$\Phi^-(a)$	$\Phi(a)$	Ranking
A1	0.3994	0.3557	0.0437	3
A2	0.2626	0.3118	-0.0492	2
A3	0.3610	0.1728	0.1882	4
A4	0.2039	0.3876	-0.1837	1

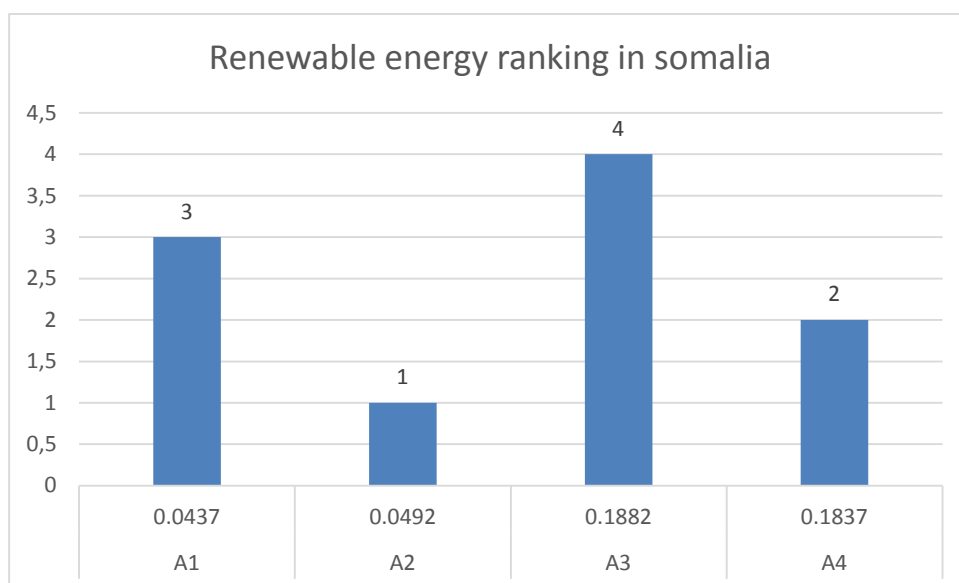

**Figure 4.4:**Renewable energy ranking in Somalia

Chart 4.1 Renewable energy ranking in somalia

From the bar chart, we can see that alternative A3 which is hydro electric power has the highest ranking in Somalia because of it is high efficiency and its high potentiality in Somalia we can conclude that it is the best suitable renewable energy in Somalia, also we can see the bar chart that A1 solar energy is the second highest ranking renewable energy in Somalia and A2 is lowest ranking renewable energy.





## 5. CONCLUSION

This thesis has been focused on Somali's renewable energy option. This small country of East Africa belongs to several economic communities. Due to its geographical location, Somalia has huge potential hydroelectric and large solar irradiation. However, despite all these assets, Somalia has a large lack of energy and continues to rank among the poorest countries in the world. In addition to being unevenly distributed, the Somali population is growing rapidly. Most Somalis live in the most remote areas. This is at the origin of a low rate of connectivity to the national power grid. Indeed, to try to find a solution to this problem related to the lack of electrical energy, a deep analysis of the energy system of Somalia was done. This implies a brief history of Somalia, its geographical situation and its socio-economic context.

After this analysis, the finding was that the access to the national electricity grid is characterized by:

Very low access to electricity: less than 5% of Somalis people has access to electricity [7]. Demand is so much higher than supply [8]. The population use firewood as the main source of energy for most artisanal or industrial thermal activities (brick making, bread making, etc.). The use of firewood is also the main fuel that the vast majority of the population uses for cooking. The supply of firewood covers only 2/3 of demand and deforestation following the search for firewood has accelerated.

Thus, given the geographical location and population growth of Somalia, the exploitation of renewable energy sources, in particular solar energy, has been considered in this thesis as a better solution to this lack of energy.

The vitality division is critical for the fulfillment of cultural needs giving legitimately or in a roundabout way the principal prerequisites for practically every one of the exercises including Human creatures, extending from prosperity and solace needs to transportation and generation frameworks. In any

case, it is presently broadly perceived that most significant natural issues get from vitality request to support Human needs and financial development. In a nation like Somalia poor energy sustainable power source utilization has turned into the biggest destroyer of the earth. The biggest wellspring of environmental contamination is non-renewable energy source ignition, on which current vitality creation and use designs intensely depend.

Somalia's capacity area faces critical difficulties, including absence of adequately prepared work, a weak authoritative condition, high theory costs, lack of imperativeness age supplies, and poor system. Given the detachment of standard endeavor finance, joined with neighborhood Islamic money related practices, Somalia has developed its own one of a kind capital-raising frameworks for structure adventures which are creating as endeavors create in size and scale. Associations have viably raised essential sums from diaspora peoples in the U.S. additionally, past for imperativeness adventures. Notwithstanding unprecedented advances made starting late by the private part to grow the creation and appointment of intensity, the yearly use of intensity per capita remains among the most diminished in Africa and customers pay a high rate 0.5-1.25 pennies/kWh appeared differently in relation to 0.15 pennies/kWh in Kenya and 0.6 pennies/kWh in Ethiopia.

Then again, new prerequisites of dependability, nature of administration and security of supply are in question, in particular having as a primary concern the pattern towards the advancement of the power advertise. In this way, in present day innovatively created social orders, choices concerning vitality arranging must be made in complex and now and then badly organized settings described by mechanical advancement, changes in market structures and new social concerns.

MCDA models and techniques along these lines empower chiefs to get a handle on the intrinsic clashes and exchange offs among the unmistakable parts of assessment and to support the examination among various elective arrangements.

The methodology created in this paper to MCDA and vitality arranging recognizes multiobjective programming models and models managing discrete elective choices. A review of the utilization of MOP models to an all-

encompassing scope of issues has been introduced concentrating on the arrangements of target capacities and imperatives just as the techniques utilized. Concerning managing discrete elective alternatives, pertinent issues are arranged and dissected, accentuating the organizing procedure and the demonstrating systems used to infer the DM's inclinations just as the strategies to get a suggestion.

It is demonstrated that in both model classifications, the choice setting is progressively increasingly mind boggling, parameters and qualities are regularly questionable and uncertain, with the goal that leaders experience more challenges in issue organizing, model structure and in entrusting the gave arrangement.

Subsequently, an unmistakable pattern towards the compelling treatment of vulnerability in actualizing MCDA in vitality. When all is said in done, assessing vitality frameworks is a mind boggling investigation that can be characterized as a multi-dimensional space of various pointers and goals. The utilization of multicriteria choice investigation (MCDA) systems gives a solid procedure to rank option sustainable power source assets, advancements and activities within the sight of various destinations and constraints. Indeed, even with the huge number of accessible MCDA strategies, none of them is viewed as the best for a wide range of basic leadership circumstances. Various techniques frequently produce various outcomes notwithstanding when connected to a similar issue utilizing same information. There is no better or more regrettable strategy however just a method that fits better in a specific circumstance. The ebb and flow research does not give a reasonable view about the pattern in writing, however can provide an understanding about the guidance it is going. It is seen that AHP is the most utilized approach of all MCDM strategies. This can be credited to its straightforward structure and the capacity of an expert to arrange results until consistency is accomplished, offering close accord on judgment. The primary inquiry that remaining parts is the manner by which to pick the fitting MCDA technique in elective vitality basic leadership In conclusion From the results we found after apply promethee method to different renewable energy in somalia according to the criteria we haved used above we can see that alternative A3 which is hydro electric power has the highest ranking in Somalia because of it is high efficiency and its high potentiality present in somalia we can conclude that it is the best suitable renewable energy in somalia,also we can see the chart 4.1 that A1

solar energy is the second highest ranking renewable energy in somalia and A1 alternative has lowest ranking beacuse of it is low efficiency and potentiality.





## 6. RECOMMENDATIONS

Based on the study, recommendations on what would be done to ensure effective energy distribution in Somalia include. For a good implementation of the results obtained during this thesis, a series of recommendations has been formulated with regard to the Government of Somalia, to the economic operators working in Somalia, to the private as well as to the Somalian researchers.

The government of Somalia:

Try to harness as much as possible the energy potential of Somalia namely the huge available hydroelectric and photovoltaic energy resources.

Update the national electricity grid in order to eradicate line losses during the transmission of electrical energy. These line losses are estimated at around 24%.

Open up the energy field to different operators and economic partners so that there is competitiveness in energy production in Somalia.

Encourage tree planting and forest protection to improve the production of firewood, which the supply is less than demand.

- b) The economic operators working in Somalia:
  - Become accustomed to energy self-sufficiency, especially through the technique of free energies such as the flywheel, bagasse as fuel and others.
  - Invest in this energetic field which is considered as the engine of all economic development
- c) Privates and households
  - The private as well as the households who have the financial means are begging to implement micro solar photovoltaic in order to supply electricity and can be fed to the neighbors who do not have financial means.

- Have the habit of using energy saving devices to reduce daily consumption.
- Use improved stoves for cooking to minimize the demand for firewood.
- d) The Somalian researchers.
  - In addition to being very interesting, the energy field is a key area in development especially for developing countries like Somalia. I would be not logical if I said that all the cases of possible enhancement of energy in Somalia have been studied throughout this work. In the same way, other researchers should deeply investigate on other kinds of Renewable energy resources that should make Somalia to eradicate the Lack of energy and then allow too many Somalians to have access to the national electric Grid.

Also the challenges of electricity in Somalia centres on three main factors [7];

I. Civil war and its aftermath.

II. Collapse of the central government, which lead to Independent power provider (IPP) to take over the responsibilities of generation, distribution and supply electricity in Somalia.

I. Lack of Regulations that controls the activities of the Independent power provider.

There is renewable energy potential in Somalia , It was concluded that a system that can combine more than one type of energy source, will be ideal for the situation in Somalia .

Stand-Alone Grid Connection (Nocart Power System) ;It can be connected with multiple different type of power units ,such as wind turbines and solar panels its economic and reliable .

The vitality or power division needs an arrangement system or guidelines that will manage the tasks of the administration, the global administrators and neighborhood administrators. There should likewise be motivator approaches that will energize various financial specialists in sustainable power source.

The Federal government needs to reinvest or draw in financial specialists to reestablish, reconnect, amplify different power frameworks, and extend the producing limit just as putting resources into sustainable power source. This will guarantee compelling age and conveyance power; most particularly in the supply of power to the remote territories, the issue of voltage drop will be limited, and the required power utilization can be met [14].

There is alack of talented sustainable power source experts in the nation. It is basic for both the administration and private bodies to arrange trainings for intrigued individuals with regards to different territories of sustainable power source. The administration ought to energize the autonomous power suppliers with motivating forces, for example, the feed-in tax and assurance credits . The individuals of Somalia ought to likewise be sharpened on the advantages of sustainable power source.



## REFERENCES

- [1] Aras H et al (2004) Multi-criteria selection for a wind observation station location using analytic hierarchy process. *Renew Energy* 29:1383–1392
- [2] Lee SK et al (2009) Decision support for prioritizing energy technologies against high oil prices: a fuzzy analytic hierarchy process approach. *J Loss Prev Process Ind* 22:915–920
- [3] Afgan NH, Carvalho MG (2002) Multi-criteria assessment of new and renewable energy power plants. *Energy* 27:739–755
- [4] San Cristóbal JR (2011) Multi-criteria decision-making in the selection of a renewable energy project in Spain: the VIKOR method. *Renew Energy* 36:498–502
- [5] Cavallaro F (2009) Multi-criteria decision aid to assess concentrated Samouilidis J, Mitropoulos C. *Energy economy models—a survey. European Journal of Operations Research* 1982;25:200–15.
- [6] Meirer P, Mubayi V. Modeling energy-economic interactions in developing countries—a linear programming approach. *European Journal of Operations Research* 1983;13:41–59.
- [7] Nijcamp P, Volwahren A. New directions in integrated energy planning. *Energy Policy* 1990;18(8):764–73.
- [8] Kavrakoglu I. Multi-objective strategies in power system planning. *European Journal of Operations Research* 1983;12:159–70.
- [9] Schulz V, Stehfest H. Regional energy supply optimization with multiple objectives. *European Journal of Operations Research* 1984;17:302–12.
- [10] Putrus P. Accounting for intangibles in integrated manufacturing-non-financial justification based on analytical hierarchy process. *Information Strategy* 1990;6:25–30.
- [11] Boucher TO, McStravic EL. Multi-attribute evaluation within a present value framework and its relation to analytic hierarchy process. *The Engineering Economist* 1991;37:55–71.
- [12] Ozelkan EC, Duckstein L. Analyzing water resources alternatives and handling criteria by multicriterion decision techniques. *Journal of Environmental Management* 1996;48:69–96.
- [13] Raju KS, Pillai CRS. Multicriterion decision making in performance evaluation of irrigation projects. *European Journal of Operational Research* 1999;112(3):479–88.
- [14] Afgan NH, Carvalho MG. Sustainable assessment method for energy systems. Boston: Kluwer Academic Publishers; 2000. Afgan NH, Gobaisi D, Carvalho MG, Cumo M. Sustainable energy management. *Renewable and Sustainable Energy Reviews* 1998;2:235–86.
- [15] Afgan NH, Carvalho MG, Hovanov NV. Sustainability assessment of renewable energy systems. *Energy Policy* 2000;28:603–12.
- [16] Climaco J, editor. *Multicriteria analysis*. New York: Springer-Verlag; 1997.

- [17] Gal T, Hanne T, editors. Multicriteria decision making: Advances in MCDM models, algorithms, theory, and applications. New York: Kluwer Academic Publishers; 1999.
- [18] Solnes J. Environmental quality indexing of large industrial development alternatives using AHP. *Environmental Impact Assessment Review* 2003;23(3):283–303.
- [19] Chang YH, Yeh CH. Evaluating airline competitiveness using multi-attribute decision making. *Omega* 2001;29(5):405–15.
- [20] Saaty TL. *The analytic hierarchy process*. New York: McGraw-Hill; 1980.
- [21] Saaty TL. *Decision making for leaders*. Pittsburgh: RWS Publications; 1992.
- [22] Brans JP, Vincke Ph, Mareschal B. How to select and how to rank projects: the PROMETHEE method. *European Journal of Operations Research* 1986;24:228–38.
- [23] Roy B. *Me'todologie multicrite`re d'aide la de'cision*. Collection Gestion, Paris: Economica; 1985.
- [24] Goicoechea A, Hansen D, Duckstein L. *Introduction to multi objective analysis with engineering and business application*. Wiley: New York; 1982.
- [25] Huang CL, Yoon K. *Multi attribute decision making: methods and applications*. New York: Springer-Verlag; 1981.
- [26] Zeleny M. *Multiple criteria decision making*. New York: McGraw-Hill; 1982.
- [27] Keeny RL, Raiffa H. *Decisions with multiple objectives: Preferences and value tradeoffs*. New York: Wiley; 1976.
- [28] Hobbs BF, Meirer PM. Multicriterion methods for resource planning: an experimental comparison. *IEEE Transactions on Power Systems* 1994;9(4):1811–7.
- [29] Huang JP, Poh KL, Ang BW. Decision analysis in energy and environmental modeling. *Energy* 1995;20(9):843–55.
- [30] Lahdelma R, Salminen P, Hokkanen J. Using multicriteria methods in environmental planning and management. *Environmental Management* 2000;26(6):595–605. Karni R, Feigin P, Breiner A. Multicriterion issues in energy policy making. *European Journal of Operational Research* 1992;56:30–40.
- [31] Mirasgedis S, Diakoulaki D. Multicriteria analysis vs. externalities assessment for the comparative evaluation of electricity generation systems. *European Journal of Operational Research*.; 1997;102(2):364–79
- [32] UNDP (2012) *Somalia Human Development Report 2012*
- [33] R. Karni, P. Feigin, and A. Breiner. Multicriterion issues in energy policymaking. *European Journal of Operational Research*, 56:30–40, 1992.
- [33] Kavrakoglu and G. Kiziltan. Multiobjective strategies in power systems planning. *European Journal of Operational Research*, 12:159–170, 1983.
- [34] R. Lahdelma, J. Hokkanen, and P. Salminen. SMAA – Stochastic multiobjective acceptability analysis. *European Journal of Operational Research*, 106:137–143, 1998.

- [35] Polatidis H et al (2006) Selecting an appropriate multi-criteria decision analysis technique for renewable energy planning. *Energy Sources Part B* 1:181–193
- [36] Chu M-T et al (2007) Comparison among three analytical methods for knowledge communities group-decision analysis. *Expert Syst Appl* 33:1011–1024
- [37] Polatidis H et al ,(2006) Building public confidence in energy planning: a multimethod MCDM approach to demand-side planning at BC gas. *Energy Policy* 25:357–375
- [38] Wang J–J et al (2009) Review on multi-criteria decision analysis aid in sustainable energy decision-making. *Renew Sustain Energy Rev* 13:2263–2278
- [39] World Bank (2015) Somali Economic Update: Transition amid Risks with a Special Focus on Intergovernmental Fiscal Relations
- [4] Burton J, Hubacek K (2007) Is small beautiful? A multicriteria assessment of small-scale energy technology applications in local governments. *Energy Policy* 35:6402–6412
- [41] Cavallaro F, Ciruolo L (2005) A multicriteria approach to evaluate wind energy plants on an Italian island. *Energy Policy* 33:235–244
- [42] Polatidis H, Haralambopoulos DA (2004) Local renewable energy planning: a participatory multi-criteria approach. *Energy Sources* 26:1253–1264
- [43] Roth S et al (2009) Sustainability of electricity supply technology portfolio. *Ann Nucl Energy* 36:409–416
- [44] Zhou P et al (2006) Decision analysis in energy and environmental modeling: an update. *Energy* 31:2604–2622
- [45] Saaty TL (1980) *The analytic hierarchy process*. McGraw-Hill, New York  
 Saaty RW (1987) *The analytic hierarchy process—what it is and how it is used*. *Math Model* 9:161–176
- [46] Somalia: Mogadishu Residents Bemoan Electricity Service Costs [Internet] 2014 [Cited July 2014] Available from: <http://allafrica.com/stories/201411280137.html>.
- [47] Istanbul conference on Somalia [Internet] 2010 [Cited July 2016] Available from: <http://somalitalk.com/2010/may/istambul/energy.pdf>.
- [48] Feasibility study of renewable energy-based microgrid system in Somaliland's urban centres [Internet] 2014 [Cited July 2016]
- [49] Saaty TL (1996) *Decision-making with dependence and feedback: the analytic network process*. RSW Publications, Pittsburgh
- [51] Cheng EWL, Li H (2005) Analytic network process applied to project selection. *J Constr Eng Manag* 131:459–466
- [52] Wang M et al (2010) Modified PROMETHEE approach for assessing energy technologies. *Int J Energy Sector Manag* 4:183–212
- [53] Wang J–J et al (2008) A fuzzy multi-criteria decision-making model for trigeneration system. *Energy Policy* 36:3823–3832
- [54] Ramachandran M ,(2004). Decision-making in energy planning-application of the ELECTRE method at regional level for the diffusion of renewable energy technology. *Renewable Energy* 2003;28(13):2063–87.

- [55] Safaei Mohamadabadi H et al (2009) Development of a multi-criteria assessment model for ranking of renewable and non-renewable transportation fuel vehicles. *Energy* 34:112– 125
- [56] Ben Salah C et al (2008) Multi-criteria fuzzy algorithm for - energy management of a domestic photovoltaic panel. *Renew Energy* 33:993–1001
- [57] Cavallaro F (2010) Fuzzy TOPSIS approach for assessing thermal-energy storage in concentrated solar power (CSP) systems. *Appl Energy* 87:496–503
- [58] Mohanty RP et al (2005) A fuzzy ANP-based approach to R&D project selection: a case study. *Int J Prod Res* 43:5199–5216
- [59] Begic F, Afgan NH (2007) Sustainability assessment tool for the decision-making in selection of energy system–Bosnian case. *Energy* 32:1979–1985 Cherni JA et al (2007) Energy supply for sustainable rural livelihoods. A multi-criteria decision support system. *Energy Policy* 35:1493–1504
- [60] KIMS (2016) Kaah International Microfinance Services Bringing Electricity to Somalia through Solar Microfinance.
- [61] Istanbul conference on Somalia [Internet] 2010 [Cited July 2016] Available from: <http://somalitalk.com/2010/may/istambul/energy.pdf>.
- [62] Feasibility study of renewable energy-based microgrid system in Somaliland's urban centres [Internet] 2014 [Cited July 2016]
- [63] Saaty TL (1996) Decision-making with dependence and feedback: the analytic network process. RSW Publications, Pittsburgh
- [64] Cheng EWL
- [65] <https://shuraako.org/sites/default/files/PoweringProgressII-DIGITAL.pdf>
- [66] <http://large.stanford.edu/courses/2018/ph241/mcnitzky2/>
- [67] <https://fortuneofafrica.com/somalia/renewable-energy-sources-in-somalia/>



## **RESUME**

**Name Surname:** Mohamed Abdullahi

**Place and Date of Birth:** Somalia 02 oct 1992

**E-Mail:** Amiincaraale@gmail.com

### **Education:**

- **Bachelor** : 2016, Istanbul Halic university , Departement Of Applied Sciences, Electrical And Electronic Engineering
- **Master** :2018, Istanbul Aydın University, Institute Of natural And Applied Sciences , Department Of Electrical And Electronics Engineering, English Program.

