



**MODELLING AND SIMULATION OF THERMAL
STRENGTH OF CLUTCH PRESSURE PLATE AND
FLYWHEEL WITH NUMERICAL ANALYSIS TECHNIQUES**

Tolga RAHAT



T.C

BURSA ULUDAĞ ÜNİVERSİTESİ
FEN BİLİMLERİ ENSTİTÜSÜ

**MODELLING AND SIMULATION OF THERMAL STRENGTH OF
CLUTCH PRESSURE PLATE AND FLYWHEEL WITH NUMERICAL
ANALYSIS TECHNIQUES**

Tolga RAHAT

Prof. Dr. Ferruh ÖZTÜRK
(Danışman)

YÜKSEK LİSANS TEZİ
OTOMOTİV MÜHENDİSLİĞİ ANABİLİM DALI

Bursa- 2019

Her Hakkı Saklıdır

THESIS APPROVAL

This thesis titled "MODELLING AND SIMULATION OF THERMAL STRENGTH OF CLUTCH PRESSURE PLATE AND FLYWHEEL WITH NUMERICAL ANALYSIS" and prepared by Tolga RAHAT has been accepted as a **MSc THESIS** in Bursa Uludağ University Graduate School of Natural and Applied Sciences, Department of Automotive Engineering following a unanimous vote of the jury below.

Supervisor : Prof.Dr. Ferruh ÖZTÜRK

Head : Prof.Dr. Ferruh ÖZTÜRK
Bursa Uludağ Ü.Mühendislik Fakültesi
Otomotiv Mühendisliği Anabilim Dalı

Signature

Member: Doç.Dr. Gökhan SEVİLGİN
Bursa Uludağ Ü.Mühendislik Fakültesi
Otomotiv Mühendisliği Anabilim Dalı

Signature

Member: Dr.Öğr.Üyesi İsmail ÖZTÜRK
Pamukkale Ü.Teknoloji Fakültesi
Otomotiv Mühendisliği Anabilim Dalı

Signature

I approve the above result

Prof.Dr.Hüseyin Aksel EREN
Enstitü Müdürü

..

I declare that this thesis has been written in accordance with the following thesis writing rules of the U.U Graduate School of Natural and Applied Sciences;

- All the information and documents in the thesis are based on academic rules,
- audio, visual and written information and results are in accordance with scientific code of ethics,
- in the case that the works of others are used, I have provided attribution in accordance with the scientific norms,
- I have included all attributed sources as references,
- I have not tampered with the data used,
- and that I do not present any part of this thesis as another thesis work at this university or any other university.

23/09/2019

Tolga RAHAT



ÖZET

DEBRİYAJ BASKI PLAKASI VE VOLANIN TERMAL DAYANIM TESTLERİNİN MODELLENMESİ VE SAYISAL ANALİZİ İLE BENZETİMİ

Tolga RAHAT

Bursa Uludağ Üniversitesi

Fen Bilimleri Enstitüsü

Otomotiv Mühendisliği Anabilim Dalı

Danışman: Prof. Dr. Ferruh ÖZTÜRK

Debriyaj, kendini oluşturan komponentler ile birlikte araç içerisindeki ana sistemlerden biridir. Debriyaj sistemi, motor ile şanzıman arasında bağlantıyı sağlamak amacıyla yerleştirilmiş mekanik bir sistemdir. Bu mekanik sistemi meydana getiren sistem ana elemanları; volan, baskı kompleksi ve disk kompleksidir. Debriyaj sistemi şanzımanı kavrarken disk ile volan arasında kademeli ve belirli bir oranda kayma gerçekleşir. Bu kavrama esnasında volan ile disk kompleksi beraber hareket ederken disk kompleksinin göbeğine geçen şanzıman mili vasıtasıyla bu hareket şanzıman grubuna aktarılır. Devir altında gerçekleşen kavrama sırasında açığa ısı çıkar. Isı kavrama sırasındaki sürtünmeden dolayı oluşmaktadır. Bu sürtünmeden açığa çıkan ısı nedeniyle volan, baskı plaka ve disk kompleksi yüzeylerinde yüksek sıcaklık artışları meydana gelmektedir. Yüzeyle etki eden yüksek sıcaklık termal deformasyon ve termo-mekanik problemler neden olur. Bu problemler ise termal çatlaklar, erken aşınma ve diğer hata modlarını beraberinde getirmektedir. Özellikle baskı plakası ve volanlarda meydana gelen termal termal çatlakların devir altında genişleyerek döküm parçaların patlamasına neden verebileceğinden dolayı yüksek risk içermektedir.

Bu tez çalışmasında, debriyaj sisteminin termal karakteristiği incelenmiştir. Deneysel test çalışmalarından elde edilen çıktılar kullanılarak sonlu elemanlar analizinin girdileri iyileştirilerek debriyaj yüzeyindeki sıcaklık dağılımının daha doğru bir şekilde benzetimi sağlanmıştır. Sonlu elemanlar analizi teorik hesaplamalar kullanılarak gerçekleştirilmiş sonrasında ise SEA çıktıları deneysel testler sırasında kayıt edilen çıktılar ile karşılaştırılmıştır. Ortaya çıkan farklılıkların sebepleri araştırılmıştır. SEA ile yapılan analizin iyileştirilmesi için teorik hesaplamalar ile deneysel verilerle elde edilen değerler arasında ilişki kurularak, SEA girdileri için iyileştirici noktalar belirlenmiştir. Ayrıca plaka yüzeyine gelen termal etkinin azaltılabilmesi için kritik komponentlerde (baskı plakası, balata) özel prototip parçalar üretilerek, parçalar aynı şartlarda test edilmiştir. Böylece malzeme değişikliğini etkisi testler ile incelenmiştir. Deneysel test sonuçları ile altyapısı sağlanan sonlu elemanlar analizi sayesinde daha doğru benzetim sonuçları elde edilmesiyle birlikte debriyaj sistemi tasarımındaki verimliliğinin artırılması sağlanacaktır. Ürün deneysel test şartlarda valide edilmeden önce, termal olarak dayanımı SEA sayesinde gözlemlenerek, parça deneysel teste alınmadan önce ürün üzerinde mühendislik iyileştirmeleri yapılmasına olanak sağlayacaktır. Buda ürün

geliştirme sürecinde ortaya çıkan prototiplerin valide edilecek seviyedeki ürüne en yakın seviyede üretilmesini sağlayarak, zaman ve maliyet konularında avantaj sağlayacaktır.

Anahtar Kelimeler: Debriyaj plakası termal testi, baskı plakası termal dayanım analizi

2019, ix + 47 sayfa.



ABSTRACT

MODELLING AND SIMULATION OF THERMAL STRENGTH OF CLUTCH PRESSURE PLATE AND FLYWHEEL WITH NUMERICAL ANALYSIS TECHNIQUES

Tolga RAHAT

Bursa Uludag University

Graduate School Of Natural And Applied Sciences

Department Of Automotive Engineering

Supervisor: Prof. Dr. Ferruh ÖZTÜRK

Clutch components are inside the main systems at the vehicle. Clutch is a mechanical device located between vehicle engine and transmission that ensure the mechanical coupling among them. Clutch system comprises of flywheel, pressure plate cover assembly and disc assembly. The clutch engages the transmission with allowing a certain amount of slippage gradually between the flywheel and disc assembly. Engagement under rpm is reason to generate frictional heat, which is leading sudden temperature increase on friction surfaces. Sudden temperature increase at friction surface could cause the thermo-mechanical problems such as thermal deformations and thermo-elastic instability, which can lead to thermal cracking, wear and other mode of failure of the clutch components. Cracks on flywheel and p.plate have tendency to extend under rotation and could be reason the burst of components. Cracks at casting parts such as p.plate and flywheel have high safety risk by bursting under rpm.

In this study, the present approach is used through the experimental test results to enhance the validity of FEA performances for understanding of the automotive clutch thermal characteristics. The thermal characteristics of the clutch is investigated by finite element analysis (FEA). The reasons for the differences were investigated. In order to improve the analysis made with FEA, the relationship among the theoretical calculations and experimental data was established and the improvement points were determined for the FEA inputs. Furthermore, in order to reduce the thermal effect on the surface of the plate, material changes were made in the critical components (pressure plate, lining) and special prototype parts were produced to test under the same condition. Purpose of material change is examining p.plate thermal strength on different materials. With the help of finite element analysis, which is provided with experimental test results, more accurate simulation results will be achieved and the efficiency of clutch system design will be increased. Before the product validation with experimental test conditions, Part's thermal resistance will be observed by FEA and it will allow engineering improvements on the product before giving the part experimental test. This will provide an advantage in terms

of time and cost by reducing prototypes numbers, which are produced during the product development process. By using FEA outputs, designer is able to make modification on product to improve its thermal strength and make optimum designed part, which is validated FEA study. Starting experimental validation tests with this level prototype is accelerated the validation time. Because these optimum parts are more able to pass experimental study than other prototypes which was not analysed with FEA

Keywords: Clutch, pressure plate thermal tests, thermal strength analysis of pressure plate

2019, ix + 47 pages.



TEŞEKKÜR

Yüksek lisans eğitimim süresince akademik anlamda bizlere örnek olan, bilgisini ve deneyimlerini her zaman cömertçe paylaşan değerli danışman hocam Prof. Dr. Ferruh ÖZTÜRK'e teşekkür ederim.

Tez çalışması sırasında tüm imkanları kullanımımıza açan ve üniversite sanayi işbirliğinde örnek çalışmalar yürüten Valeo Otomotiv sistemleri end. A.Ş ve çalışanlarına teşekkür ederim.

Ayrıca tüm eğitim hayatımda maddi ve manevi desteğini esirgemeyen aileme sonsuz şükranlarımı sunarım.



Tolga RAHAT

23/09/2019

Contents

ÖZET.....	i
ABSTRACT.....	iii
SYMBOLS and ABBREVIATIONS.....	vii
FIGURES.....	viii
TABLES.....	x
1.INTRODUCTION.....	1
2. LITERATURE SEARCH.....	6
2.1. Determination of Convection Heat Transfer Coefficient.....	8
2.2. Calculation Methodology of Convection Heat Transfer Coefficient.....	10
2.3. Calculation of Convection Heat Transfer Coefficient.....	11
2.4. Finite Element Analysis of Clutch Assembly.....	12
3. MATERIAL AND METHOD.....	13
3.1. Over Shock Thermal Validation Tests.....	14
3.1.1 Over Shock Thermal Validation Tests.....	15
3.1.2 Over Shock FEA Thermal Test.....	20
3.2. Over Shock Test Outputs Comparison for FEA & Experimental Study.....	23
3.2.1. Over Shock Test Outputs Comparison for FEA & Experimental Study.....	25
3.3. Hill Start Thermal Validation Tests.....	27
3.3.1 Hill Start Experimental Bench Test Study.....	28
3.3.2 Hill Start FEA Study.....	30
3.3.3 Comparative Hill Start Bench Test on FEA study.....	31
3.4. P.Plate Material Effect Searching on P.Plate Strength.....	33
3.5. Facing Friction Material Effect Searching on P.Plate Strength.....	35
4. RESULTS AND DISCUSSION.....	39
4.1. Over –shock Thermal Test.....	39
4.2. Hill Start Thermal Test.....	41
4.3. P.plate Material Change.....	42
4.4. Facing Material Change.....	42
5. CONCLUSION.....	44
REFERENCES.....	46
RESUME.....	47

SYMBOLS and ABBREVIATIONS

Symbols	Definition
$\Phi(t)$	The per unit time by the heat of the heat transfer area
S	The thermal area;
$q(t)$	The unit area per unit time heat flow through
r	The radius of the study points
N(t)	The sliding friction power in a function of
$T_c(t)$	The torque by transmission system
$w_e(t)$	The engine speed
$w_c(t)$	The rotate speed of transmission system
h	The convection coefficient
I	Inertia of bench
E	Energy
T_p	Slipping Time
μ	Friction coefficient
w	Angular velocity

Abbreviation Definition

HEL	High Energy Level
FEA	Finite Element Analysis
GCW	Gross Combined Weight
GVW	Gross Vehicle Weight
CVW	Curb Vehicle Weight

FIGURES

	Page
Figure 1.1. Major components of a clutch system	1
Figure 1.2. Clutch System Engaged – Disengaged Condition	2
Figure 1.3. Sub-components of PPCA	2
Figure 1.4. Pressure Plate Design	3
Figure 1.5. Pressure Plate Movement on engagement – disengagement	3
Figure 1.6. P.plate total failure at field.....	4
Figure 2.1. Usual assumption for heat distribution	7
Figure 2.2. Pressure plate speed	8
Figure 2.3. Convection Heat Transfer area calculation. Total Surface Area - Friction Area (Heat Flux area).....	11
Figure 3.1. The flow chart of present approach	14
Figure 3.2. Clutch full-size bench	15
Figure 3.3. Schematic diagram of clutch full size bench	16
Figure 3.4. Thermocouple location inside p.plate (Valeo Thermal Test Procedure	17
Figure 3.5. Thermocouple which is located inside the p.plate.....	17
Figure 3.6. An example thermal visualized curve of experimental study.....	18
Figure 3.7. Test Part picture after thermal test with a crack on p.plate surface	19
Figure 3.8. Rotational Test Bench (Valeo Test Center).....	19
Figure 3.9. Test part assembly inside the Rotational Test Bench (Valeo Test Center) ..	20
Figure 3.10. Schematic diagram of the burst test bench	20
Figure 3.11. Pressure plate Cad Design in the Catia V5 R20	21
Figure 3.12. Creating a mesh structure in Ansys Workbench.....	21
Figure 3.13. Creating a mesh structure in ANSYS Workbench	22
Figure 3.14. Peak Temperature area close view	22
Figure 3.15. Comparison output of FEA and experimental study	23
Figure 3.16. Comparison of maximum temperature generated from FEA and experimental study	24
Figure 3.17. Slipping time comparison between FEA and experimental study.....	25
Figure 3.18. FEA analysis with updated slipping time using correction factors	26
Figure 3.19. Comparison of maximum temperature generated from updated FEA and experimental study	27
Figure 3.20. Transmitted torque calculation	27
Figure 3.21. Resistance torque calculation	28
Figure 3.22. An example study for Energy (kj) versus Slope Study (Valeo Training Document).....	28
Figure 3.23. Bench test simulation hill start (TÜV) with same kind of energy	29
Figure 3.24. Experimental hill start test with GS500 p.plate material	30
Figure 3.25. Hill Start Test FEA output.....	31
Figure 3.26. Hill Start Test FEA outputs as Temperature vs Time.....	31
Figure 3.27. Hill Start Test FEA outputs as Temperature vs Time.....	32
Figure 3.28. Comparison of GV 300 and GS 500 (Valeo Cast Iron Guide).....	34
Figure 3.29. Experimental Test results for GV300 and GS 500 Material.....	35
Figure 3.30. Valeo Organic Facings (Valeo Technical Instruction for HEC)	36
Figure 3.31. Hill Start Bench Test Average Torque Measurements	37

Figure 3.32. Single Facing μ measurement under thermal condition (Valeo μ measurement) 38
Figure 3.33. Hill Start Bench Test P.Plate Temperature Measurement 38
Figure 4.1. Friction Coefficient (μ) change versus temperature (Valeo Tests) 40
Figure 5.1 Excessive thermal loaded p.plate with crack surface 44



TABLES

	Page
Table 2.1. Convective heat transfer coefficient of pressure plate	8
Table 3.1. Correction Factor Table for slipping time.....	26
Table 4.1. Max Pressure Plate Temperature	41



1.INTRODUCTION

Clutch system provides the engagement between engine and the transmission as providing mechanical coupling among the system. Main parts of clutch system are consisting from flywheel, pressure plate cover assembly (PPCA) and disc assembly as given in Figure 1.1.

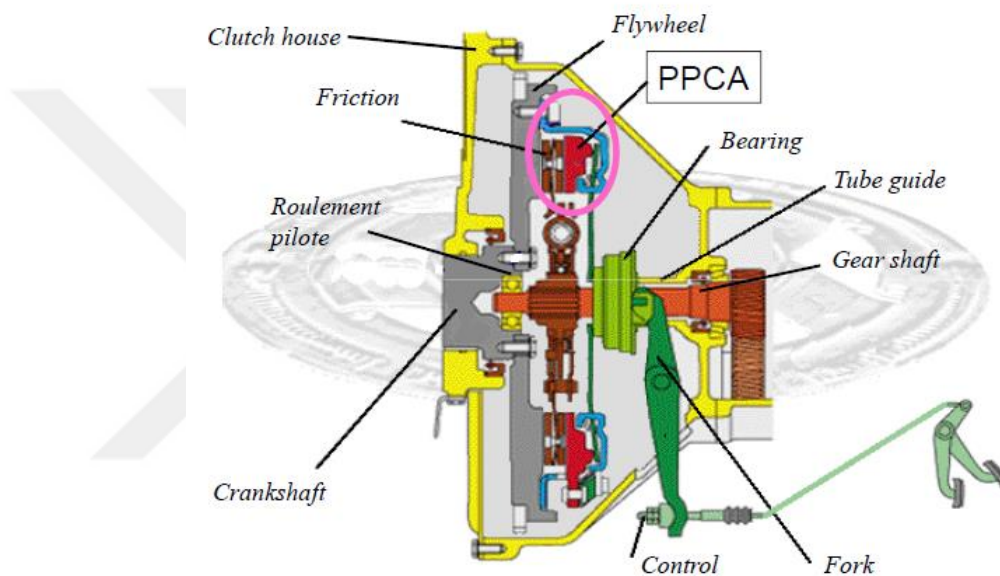

Figure 1.1. Major components of a clutch system
(Valeo Training Document)

The flywheel is screwed to the engines crankshaft. It is a large casting metal disc, which is transferring crank rotation to the clutch system. The flywheel provides a mounting surface for the PPCA, and dissipates heat.

The clutch disc is the providing link between the engine and the transmission. It is used in such a way as to provide torque transmission during engagement and interrupt torque transmission during disengagement as indicated below Figure 1.2. Usual facings are made by organic material that provide coefficient of friction greater than 0.27. When facings

temperature is too high, seen a gas generation that lubricates the facings area and this friction coefficient is falling down. This is leading the clutch slipping, clutch is not able anymore to pass the engine torque.

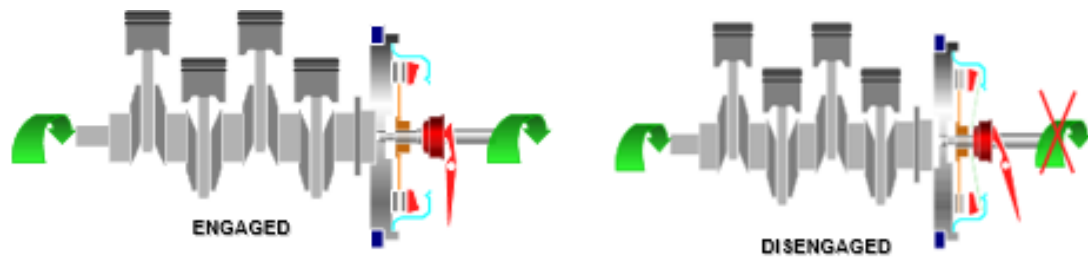

Figure 1.2. Clutch System Engaged – Disengaged Condition
(Valeo Training Document)

The PPCA is fixed to the flywheel and provides the clamp load which is needed to apply pressure the clutch disc to properly torque transmission. It is important that the assembly be well balanced and able to absorb the heat generated when the clutch disc is engaged.

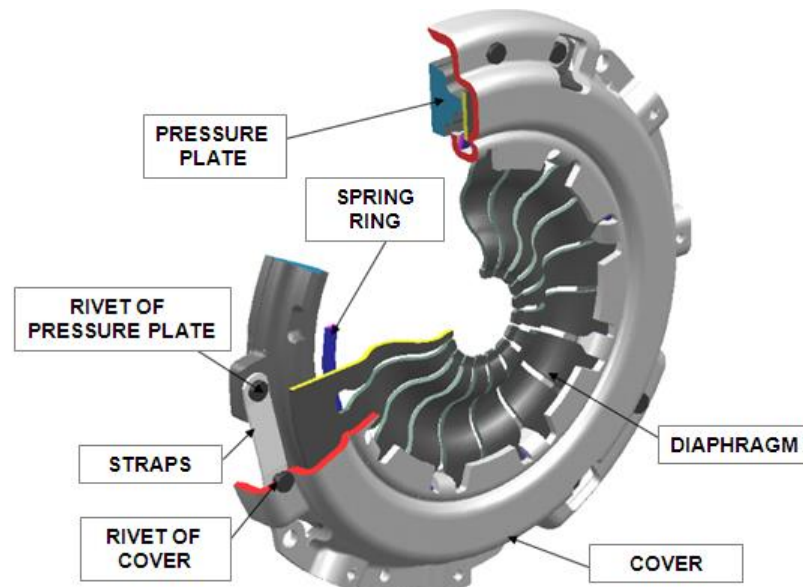

Figure 1.3. Sub-components of PPCA
(Valeo Training Document)

As seen above figure 1.3, the part forming the friction surface is called the pressure plate. This part creates a friction surface and provides torque transmission. This part, which is cast metal, absorbs the energy released during the engagement. In addition, it breaks the torque transmission by breaking the connection with the disc by moving linearly by straps.

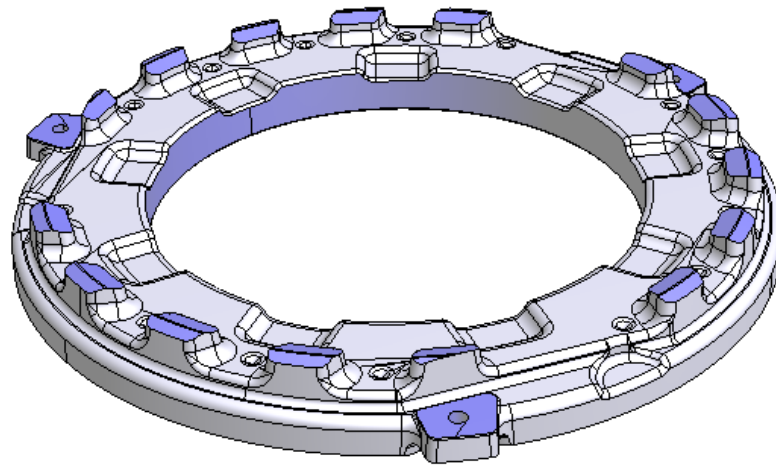

Figure 1.4. Pressure Plate Design

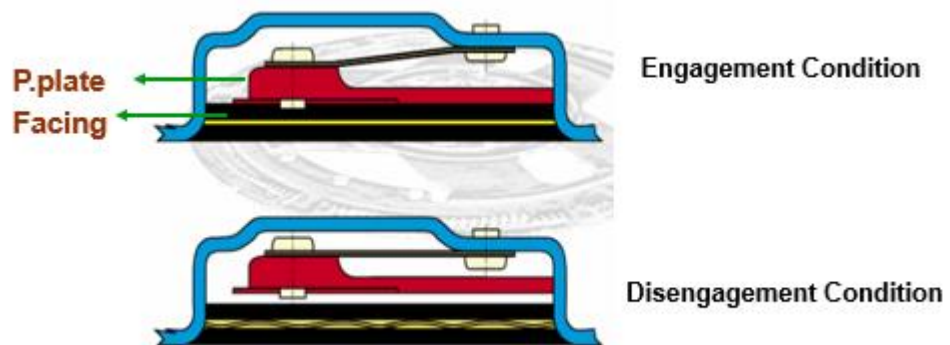

Figure 1.5. Pressure Plate Movement on engagement – disengagement

Mechanical engagement is generating frictional heat on contact surfaces due to slipping among the surfaces. Thermal distortions of friction discs, plates, flywheel friction surfaces are caused by this generated higher heat and pressure distribution on friction surfaces. If high excessive thermal over load is generated on friction surfaces, excessive heat distribution can cause deformations, wear and surface cracks on casting part. In this

case, early failure of clutch is leading the malfunction of clutch system which could reason the end user complaint by not to transmit torque vehicle on road such as below burst pressure plate part.

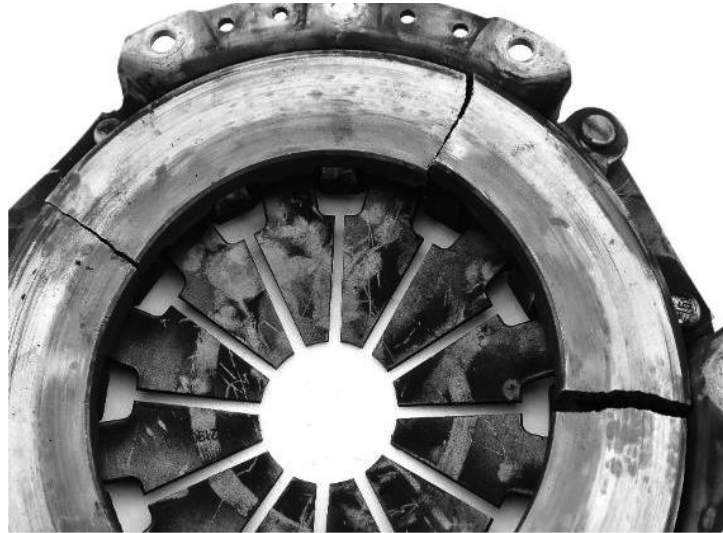

Figure 1.6. P.plate total failure at field

(<https://www.australianclutch.com.au/troubleshooting-guide/loss-of-drive/burst-pressure-plate>)

Therefore, temperature distribution on contact surfaces must be known to prevent early failure of clutch system. Clutch failure and damage due to excessive frictional heat and heat fluctuations to the clutch pressure plate and flywheel often happens to any type of automotive clutches. Failure mode due to pressure and thermal distributions are determined by several researchers in literature (Abdullah ve ark, 2018, Abdullah and Schlattmann, 2016, Fu ve ark., 2010, Zhao ve ark., 2016, Wang ve ark. 2014).

In literature, an estimation of temperature distribution is considered necessary to avoid the premature failure of friction clutches. A method which can be used to calculate the heat flux and the heat transfer coefficient is proposed. A simulation analysis of thermal stress coupling of the pressure plate is made in order to calculate temperature distribution and the stress level of the pressure plate (Wang ve ark., 2014). FEA is used to determine temperature distribution, heat generation and the contact pressure distribution on frictional surfaces using 3D model to simulate the thermo structural coupling in automotive clutches. (Abdullah ve Schlattmann, 2014). Different materials are chosen to

evaluate the suitability of two conventional and one non-conventional material used in clutches. It is shown that the non-conventional material (composite of aluminium matrix and ceramic particles) may be used for the clutch parts for better mechanical and thermal properties (Glodová ve ark., 2014). Clutch assembly is designed and finite element analysis was performed for a clutch assembly. The plots for equivalent stress, total deformation and factor of safety are obtained and the design is optimized to reach a safe clutch design as indicated another study. (Purohit ve ark., 2014). A thermal model of clutch is converted into C-code for Engine Control Unit (ECU) implementation. It is presented that clutch thermal overload protection enables longer service life of the powertrain and especially for dry clutch disc without modifying mechanical parts in the powertrain. (Güneş, 2015). Common study as FEA is used to model frictional heating process and simulate thermal analyses in disc brakes and clutches to study the temperature and stress distributions during operation (Adamowicz ve Grzes, 2013).

Although there are several papers in literature, in here, only some of the related ones, which are traced through the literature survey, are given. It is seen that FEA is mostly used to model and simulate the thermal distributions in clutch system to determine failure mode cases. It is also seen that there is a need to enhance simulation performance and validation of thermal analysis of clutches. In this study, the thermal characteristics of the clutch are inspected. Thermal experimental validation test outputs from experimental phase are used to improve the inputs for finite element analysis to identify the temperature distribution at the clutch. The thermal analysis is done using ANSYS finite element software. Later, results compared with experimental validation test results. Both results are then compared for better justification of the finite element analysis results. This study has significant advantages to be able to perform experimental study by using full size energy test machine that is specially designed to simulate thermal effect on the clutch system. It is a very rare test machine due to its complex structure, special software and other unique features. Since many researchers do not have the privilege to use this this full size test machine, the experimental side is weak in their studies. In this study, the use of full size thermal test machine provides a clear advantage and brings a different perspective from other academic studies.

2. LITERATURE SEARCH

Most of failures in automotive friction clutches occur due to the excessive heat generated between the contact surfaces during the slipping period. When the car starts, the heat generated on the pressure plate is caused by the friction work generated by the sliding friction in the clutch engagement, heat flux of the friction surface is could be calculated by below formulas which was taken reference an other study. (Wang ve ark, 2014):

$$q(t) = \left(\frac{\Phi(t)}{S} \right) \quad (2.1)$$

$\Phi(t)$: The per unit time by the heat of the heat transfer area

S : The thermal area;

$q(t)$: The unit area per unit time heat flow through

By simplifying the calculation, in the process of clutch engagement when the car starts, the relationship between sliding friction power and heat flux density at a point on the friction plate produced as follows (Wang ve ark., 2014):

$$q(t) = \left(\frac{3r}{2\pi(r_2^3 - r_1^3)} \right) N(t) \quad (2.2)$$

r_1 r_2 : Inner and outer diameters of plate

r : The radius of the study points

$N(t)$: The sliding friction power in a function of

The heat flux depends on the slippery ground power, but the slippery ground power is constantly changing through the process of clutch engagement, the value is related with the transmission torque of the transmission system and the rotational speed difference as indicated study (Wang ve ark., 2014).

$$N(t) = T_c(t)[\omega_e(t) - \omega_c(t)] \quad (2.3)$$

$T_c(t)$: The torque by transmission system

$\omega_e(t)$: The engine speed

$\omega_c(t)$ The rotate speed of transmission system

In the process of clutch engagement, assuming that the heat generated by the friction all absorbed by the pressure plate friction, plate (flywheel); and facing with the below the ratio of the absorption of heat (Minereau, 1988).

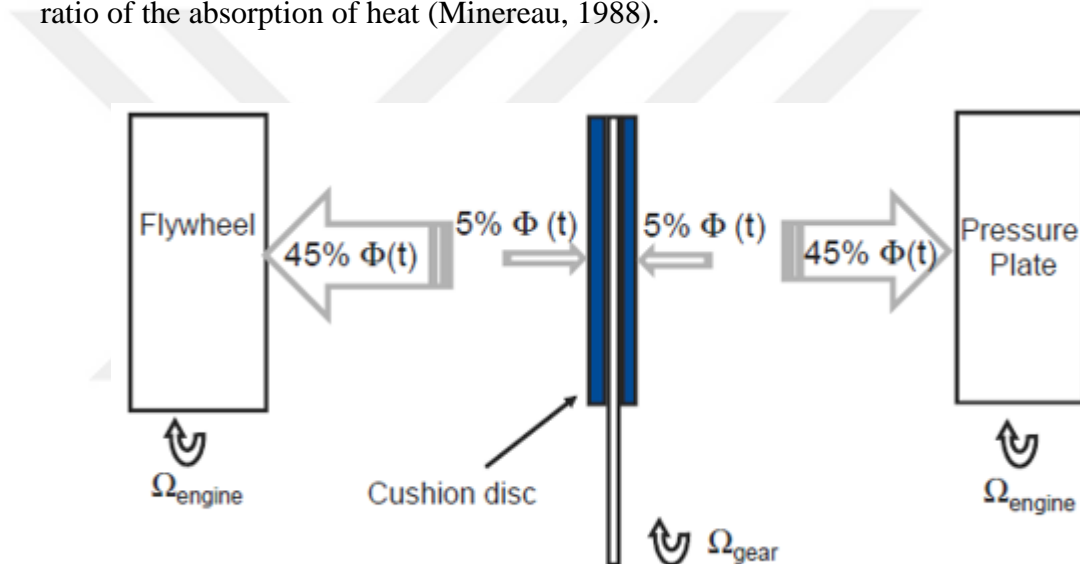

Figure 2.1. Usual assumption for heat distribution

90 % of dissipated heat absorbed by p.plate and flywheel as equal sharing

10 % of dissipated heat absorbed by both facings (GB side and Flywheel side)

$$A(t) = B(t) + C(t) \quad (2.4)$$

$A(t)$: Energy provided by the engine

$B(t)$: Useful energy to move the vehicle

$C(t)$: Energy dissipated by friction within the clutch

2.1. Determination of Convection Heat Transfer Coefficient

Convective heat transfer coefficient is changing by the speed of the pressure plate and the surrounding temperature. Pressure plate speed vs time graph was measured with below study (Wang ve ark. 2014).

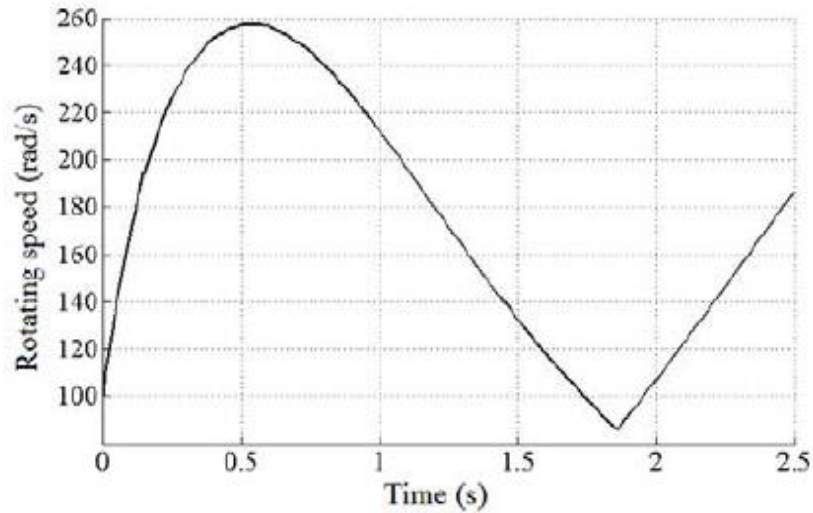

Figure 2.2. Pressure plate speed (Wang ve ark 2014)

Table 2.1. Convective heat transfer coefficient of pressure plate (Wang ve ark 2014)

Surface	50 (rad/s)	100 (rad/s)	150 (rad/s)	200 (rad/s)
Inside diameter side of the pressure plate	13.35	22.68	29.79	36.25
Outer diameter side of the pressure plate	17.11	27.65	38.50	47.44
The end face of the pressure plate	12.70	20.96	30.06	35.49
The top surface of the supporting platform	12.37	18.91	26.57	32.15
Outer diameter side of the support table	13.03	23.25	30.05	36.25
Inner diameter side support of the support table	13.02	22.40	29.26	35.49
Desk side support	8.58	14.95	22.68	26.84

Experimental study is carried out to be used for theoretical calculations which these values are used as the inputs for analysis and design improvement were done to increase the thermal strength of the p.plate at study of Wang ve ark. 2014. They have made improvements of pressure plate structure for pressure plate temperature rise. Rivet holes were increased from 1 to 2 at each support to reduce concentration of stress. A blast tendon are designed in the middle of riveting holes and the supporting table, which increase the pressure plate axial strength. The quality of pressure plate quality was increased as 2.5 %. The analysis is repeated by changing the plate design and the improvement between the two designs is shown according to the analysis result. However, the analysis results are not compared through the experimental test study.

In other study which was done by Abdullah, O., Schlattmann, J. (2016), axisymmetric models of a single-disc friction clutch considering different assumptions are enhanced. The results show the transient thermal behavior of a friction clutch system during the engagement period (heating phase), when the clutch starts to torque transmission. The analysis considers two types of load (heat flux) based on the design theories of the friction clutches. These theories are called uniform pressure and uniform wear. The results presented the temperature field of friction clutch disc based on uniform pressure and uniform wear assumptions. Indicating the failure existing in the results and distribution of temperature field when assumes a uniform wear between the contact surfaces. The heat flux is uniformly distributed on the friction surface of clutch disc at any time when assumes a uniform wearing. The temperatures outputs based on this assumption nearly are equal to the temperature outputs at the mean disc radius when considers a uniform pressure among the friction surfaces. The outputs with this assumptions aren't giving the real values of the maximum temperature and the temperature variation with disc radius.

On other aspect during temperature calculation of above study by Abdullah, O., Schlattmann, J. (2016), field of disc based on a uniform pressure consideration, the heat flux increases linearly with disc radius. The minimum temperature will be seen at the inner disc radius and the maximum temperature value will be seen at the outer disc radius at any time during the slipping time. A good agreement with results of other researchers using different approaches is obtained which proves the numerical model based on a

uniform pressure assumption to deal with the slipping operation of friction clutches system. Results from their study indicates that the calculation of the temperature distribution based on a uniform wear will miss lead designers with obtaining inaccurate estimation of lifecycles of friction clutches due to the failure in assumption.

In the present approach, the analysis is done according to the theoretical calculation as described in the following sections. The output of analysis (the temperature of the plate surface) was compared with the experimental test results that were obtained from full size thermal testing machine. It is found that there is a gap among the temperature values for recorded during experimental test and the FEA results. Subsequently, the analysis inputs are improved (by setting the corrective factor) with the values obtained in the experimental test, and the FEA is repeated to achieve better correlation.

2.2. Calculation Methodology of Convection Heat Transfer Coefficient

Bell house is located between engine and transmission. Half of the housing is the part of transmission and remaining space is the part of engine block. It essentially takes inside the disc assembly, PPCA, flywheel and linkages from environmental damages as water, dust. It transfer all the heat that is coming from bell air and engine to the environment. Thermal convective resistance between bell housing and environment is related mainly to the vehicle speed. As vehicle speed is increased, heat transfer to the environment is increased. Environment temperature does not have main effect on heat transfer coefficients as indicated study of Güneş, F.E. (2015).

Calculations of the convection coefficients are closely related to the air circulation in the housing. Two ways are being considered to estimate them:

In CFD calculation, total dissipated heat from pressure plate to clutch house air includes radiation and convection and convective heat transfer coefficient can be computed from Equation written above.

$$Q_{conv} = h A \Delta T \quad (2.5)$$

Where, Q_{conv} is the convective heat transfer rate, A is the surface area and the ΔT is the temperature difference. Another method to calculate the convective heat transfer coefficient is prediction by using test results. In this study, the second way was utilized for the estimation of convective heat transfer coefficients. Estimation using the test results, which give the value of $h.S$ where H : convection coefficient and S : surface of the plate. (Valeo Test Method used to calculate thermal exchange coefficient hS)

2.3. Calculation of Convection Heat Transfer Coefficient

In this study, Valeo Test Method used to calculate thermal exchange coefficient hS . Surface of the plate (S) was obtained removing friction area from whole p.plate area by using CAD data as seen Figure 2.3.

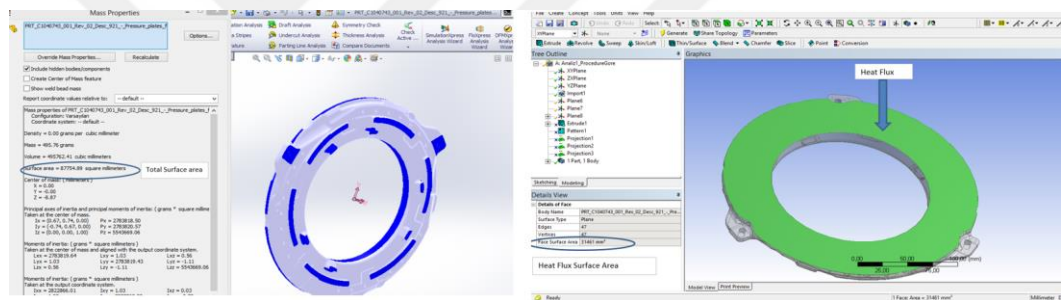

Figure 2.3. Convection Heat Transfer area calculation. Total Surface Area - Friction Area (Heat Flux area)

After definition of S [mm²] as above, convection coefficient is calculated with below formula;

$$h = \frac{h.S}{S} \quad (2.6)$$

h : Convection Coefficient $\left[\frac{W}{mm^2 K} \right]$

$h.S$: Value obtained from experimental study $\left[\frac{W}{K} \right]$

S : Surface area for convection heat transfer [mm²]

2.4. Finite Element Analysis of Clutch Assembly

The finite element analysis is becoming a widely accepted method as computational tool in engineering analysis. Thanks to solid modelling, the component is defined to the computer and this definition provides sufficient geometric data for construction of mesh for finite element modelling. Purohit and friends (2014) explained Finite Element Analysis of Clutch Assembly in their study with below orders.

- 1) Clutch dimension calculation
- 2) Material definition for the parts
- 3) Creating a 3D model of the parts
- 4) Exporting the 3D model to ANSYS for simulation and creating mesh
- 5) Assigning the material property and geometry
- 6) Defining the Environment (a combination of loads and supports)
- 7) Installing the Model to the ANSYS solver; Obtaining Solution (Equivalent von-Mises stress, Total Deformation and Stress Tool) and evaluation of the results

Purohit and friends (2014) study results show that designed friction clutch assembly is inside the safe zone by Finite element analysis (performed in ANSYS software). They have analysed 3 main components at their study as clutch plate, pressure plate and diaphragm spring. They have performed the finite element analysis at three steps: Preprocessing, Solving and Post processing. The plots for Equivalent von-Mises stress, total deformation and stress tool (factor of safety) were calculated and analyzed.

3. MATERIAL AND METHOD

Clutch manufacturers are preparing a Design Validation Test Plan (DVTP) for each product during the development phase by negotiating with OEM customer. Clutch supplier can also have extra tests inside the DVTP except customer requirement to clarify robustness of design. It is necessary to obtain a positive result from all planned tests to be able to transfer the product to serial production. During validation phase, clutch manufacturer validates its product by considering its know-how and customer specific requirements. Even if product has less possibility to operate under extreme conditions, clutch supplier is determining test conditions and acceptance criteria by considering these extreme conditions.

Commonly experimental studies is not affordable because of prototype costs and re-design studies in case of NOK test results so clutch manufacturers are looking for short ways to make a quick design evaluation to define most suitable design and reducing the number of experimental tests. Finite Element Analysis is facilitating this requirement and accelerating the validation phase while saving time and cost.

In this study, the thermal characteristics of the clutch system are determined. Outputs obtained from the experimental test results and compared with the inputs obtained by theoretical calculation method during the analysis to reveal the differences. Based on the experimental studies, a more accurate simulation of the temperature distribution is provided by FEA through improved inputs. The present approach will provide better understanding of the thermal properties of the clutch system seen at Figure 3.1.

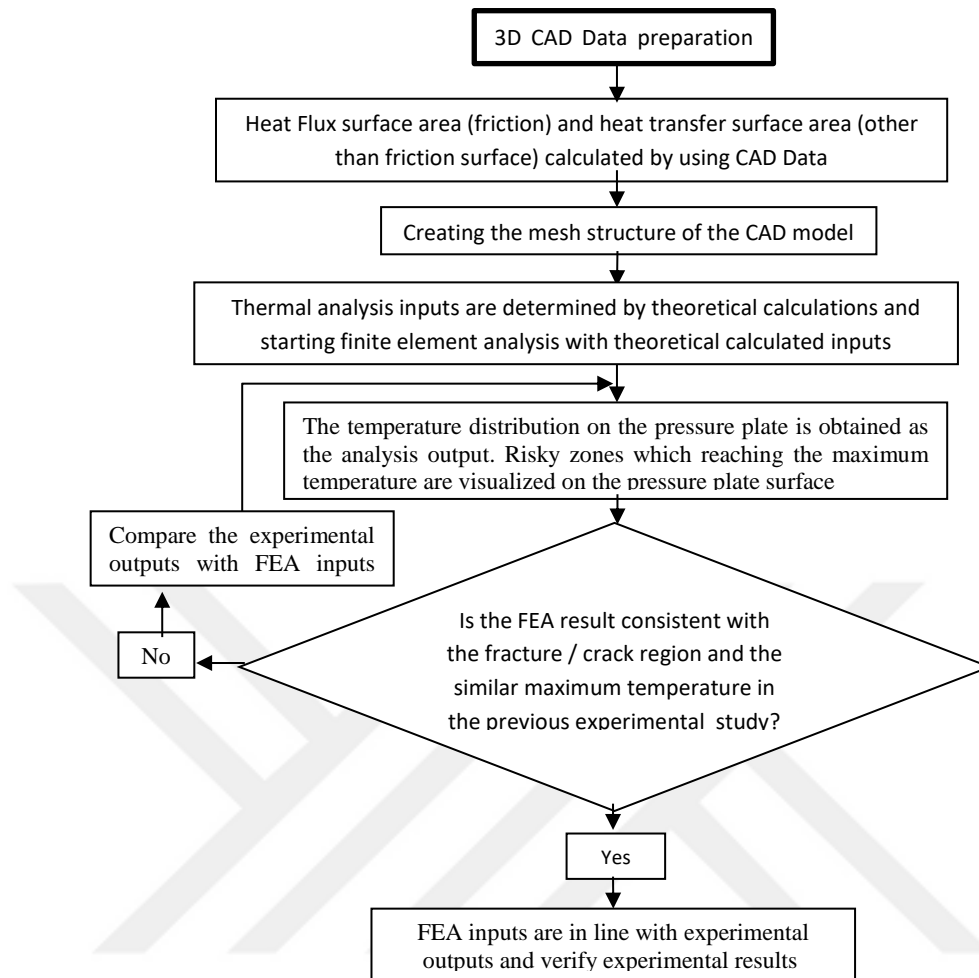

Figure 3.1. The flow chart of present approach

3.1. Over Shock Thermal Validation Tests

Clutches & flywheels are validated during developments in order to avoid identified failure risks on vehicle.

- In conditions representing clutch & flywheel functionalities: Characterization tests.
- In conditions representing clutch life time : Durability tests.
- In extremes conditions in order to assess their limits : Tests at limits.
- In extreme conditions representing abusive use: Abusive tests.

Thermal validation tests are used to verify the mechanical strength of clutch systems components, which are machined casting parts such as pressure plate and/or of DMF secondary flywheel or flexible flywheel or single mass flywheel. Thermal tests are used to highlight the cases that is giving feedback about dimensioning; the geometry and the material choice could give some bursts on vehicle as example given Picture 1.1. Thermal tests are performed on bench in order to assess.

3.1.1 Over Shock Thermal Validation Tests

Over shock test, which is simulating the repeated thermal shock, is based on an energy level E multiple of High Energy Level (HEL) obtained from vehicle Energy Level, taking into account the highest one. HEL could be shared by customer or to be defined from table with considering clutch size, which is prepared by supplier knowledge.

Energy level (E) is defined by multiple of High Energy Level (HEL) with specific coefficient. It is taken account by manufacturer experience such as 1 x HEL, 2 x HEL, 3 x HEL etc.



Figure 3.2. Clutch full-size bench

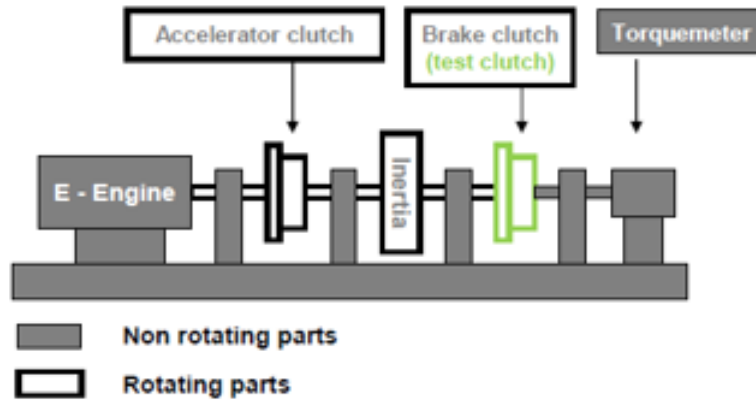

Figure 3.3. Schematic diagram of clutch full size bench

The test pieces are mounted in the area indicated above in green. The part of the test pieces is covered with a chamfer during the thermal test to simulate the clutch housing. Vehicle engine is simulated by electrical engine. Thermal bench is equipped with special software, which lets to monitor all inputs / out puts of tests. Input parameters are prepared with below methodology.

The starting rotation speed is defined by the following formula (Valeo Thermal Test Procedure).

$$N = \frac{60}{2\pi} \sqrt{\frac{2000 E}{I}} \quad (3.1)$$

E: Energy [KJ]

I: Inertia of bench during braking [kg m²]

N: Rotation speed [rpm]

N (Rotation speed) of electrical engine is defined by using above formula. Remaining parameters could be easily found by below order.

HEL: High Energy Level [KJ]: Data from OEM or from table by clutch size

E: Energy [KJ] : Special Coefficient x HEL

I: Inertia of bench during braking [kg m²]: It is a constant value based on test bench capacity.

Test bench assembly is representative of complete clutch system and flywheel. In case of pressure plate validation, flywheel could be chosen as fake for simulating original flywheel conditions. The components such as (pressure plate, flywheel) will be equipped with a probe to able to save temperature records during test by inserting thermocouple as seen Figure 3.4.

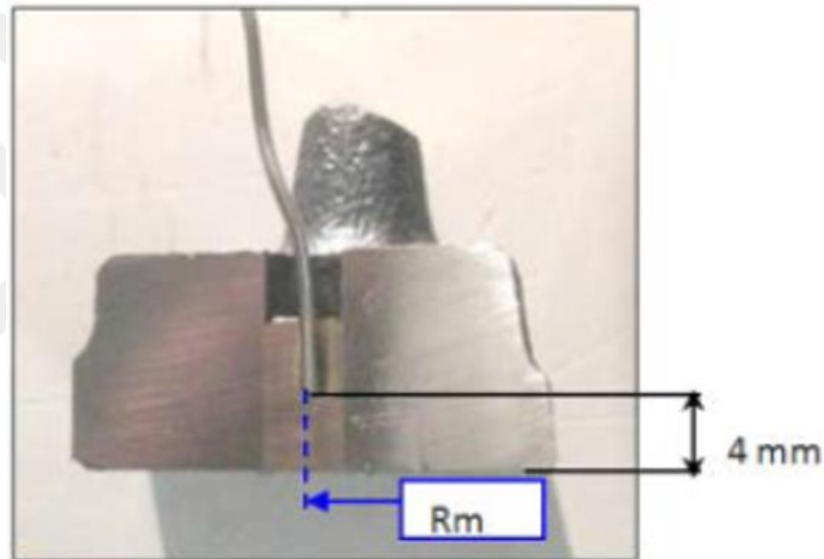

Figure 3.4. Thermocouple location inside p.plate (Valeo Thermal Test Procedure



Figure 3.5. Thermocouple which is located inside the p.plate

A Thermocouple is used for record the temperature on p.plate surface during thermal test. Thermocouples consist of two wire legs made from different metals. The wires legs are welded together at one end, creating a junction. This junction is where the temperature is measured. When the junction experiences a change in temperature, a voltage is created. The voltage can then be interpreted using thermocouple reference tables to calculate the temperature (www.thermocoupleinfo.com).

The objective in this thesis was only studying on p.plate the thermal strength. Thus PPCA and disc assembly are used as original product but flywheel was represented with fake part.

Torsional kinetic energy was calculated with above formulas and test inputs were defined for test bench. During the test parameters were recorded such as temperature, speed and torque for each cycles and results are visualized as given in Figure 3.6.

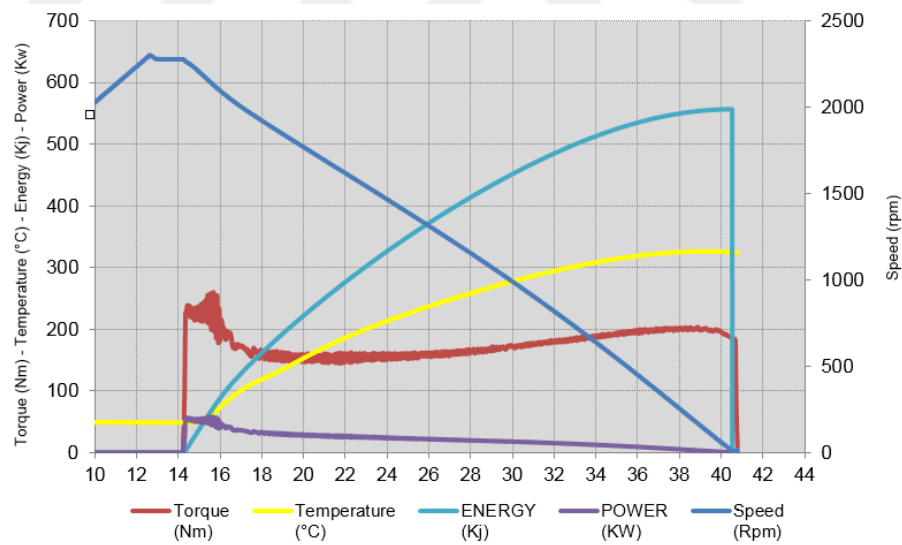

Figure 3.6. An example thermal visualized curve of experimental study



Figure 3.7. Test Part picture after thermal test with a crack on p.plate surface

After tests, parts are checked against to crack or breakage on the pressure plate and/or the flywheel as seen Figure 3.7. If there is not any crack case, then rotational test must also be applied to the parts after thermal test. Thermal part is rotated at least higher than max engine rpm against to micro cracks inside the part.



Figure 3.8. Rotational Test Bench (Valeo Test Center)

Test parts are implemented inside the burst test bench chamfer. Acceleration, inertia and other parameters are used as input to software. Part is rotated with defined condition and there must be no burst on the part to be able to validated after thermal shock tests.

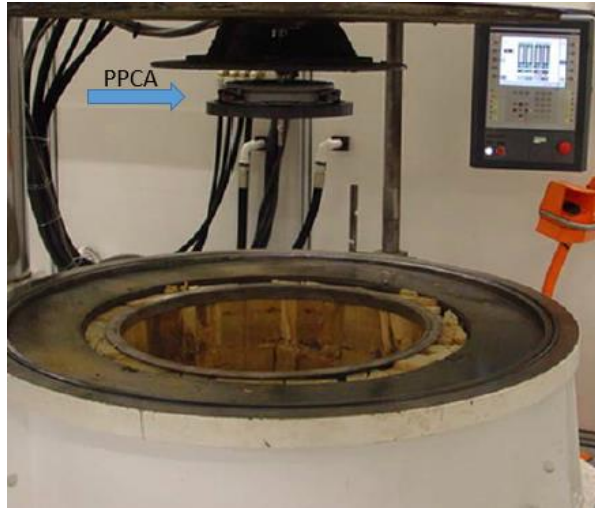

Figure 3.9. Test part assembly inside the Rotational Test Bench (Valeo Test Center)

The test piece is placed on a shaft-supported apparatus that can rotate around 360 degrees. Part was rotated until defined rpm value and waited as defined time this rpm value. After that de-acceleration is started.

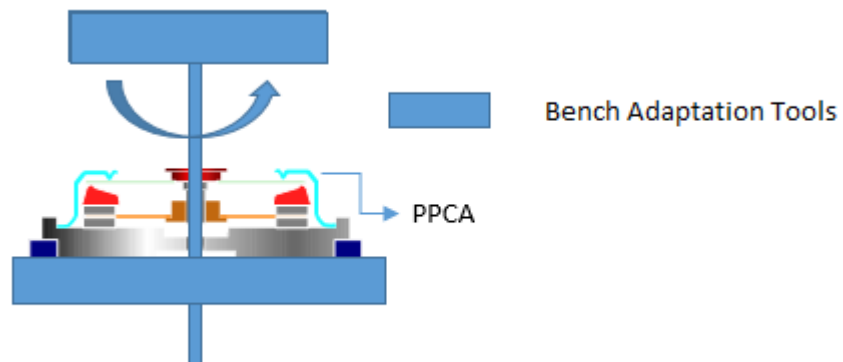

Figure 3.10. Schematic diagram of the burst test bench

3.1.2 Over Shock FEA Thermal Test

The CAD file designed in the Catia V5 R20 as seen in Figure 6 and saved with the .stp extension and imported into the Ansys. The thermal analysis were performed by using ANSYS finite element software.

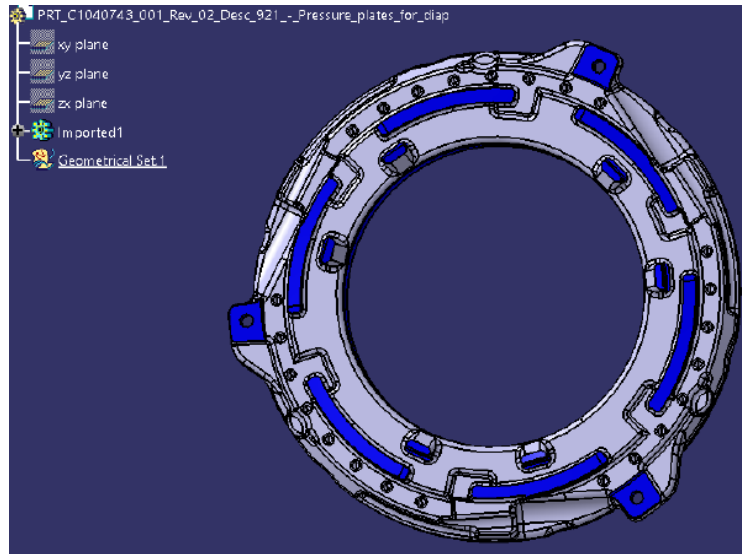

Figure 3.11. Pressure plate Cad Design in the Catia V5 R20

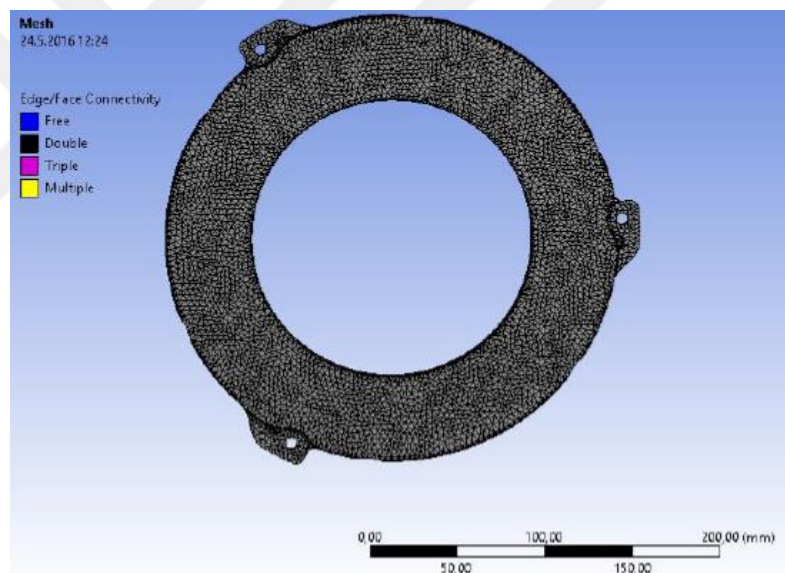

Figure 3.12. Creating a mesh structure in Ansys Workbench

In this study, environment temperature was considered as 25 °C before starting torque transmission same as Wang and fri. 2014 study. Importing the calculated heat flux into the friction surface of pressure plate through the programming; there is some convection heat transfer between the rest surface of pressure plate and air, applying the function written corresponding to time piecewise linear interpolation the convective heat transfer coefficient at each feature speeds to the platen surface (Wang and fri. 2014). Border

condition was defined on Ansys program and outputs of FEA was obtained as Figure 3.12.

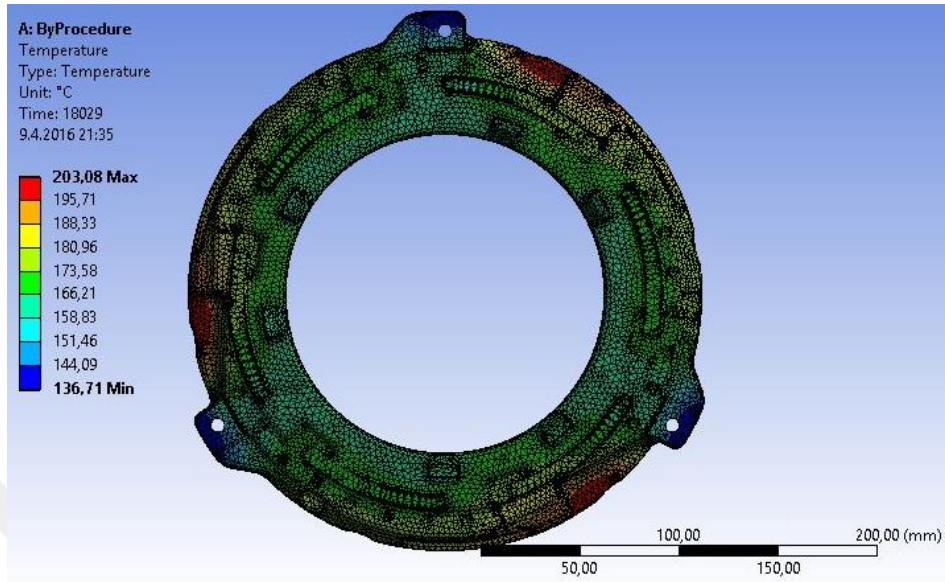

Figure 3.13. Creating a mesh structure in ANSYS Workbench

According to the simulation, the peak temperature was recorded as 203.08 °C. In the bonding process, the high-temperature region is focused on the non-continuous area, as seen in Figure 3.13. Since the speed of the outer edge of the slipper grows faster, the temperature of the region is highest at the outer diameter and concentrated non-continuous radius area.

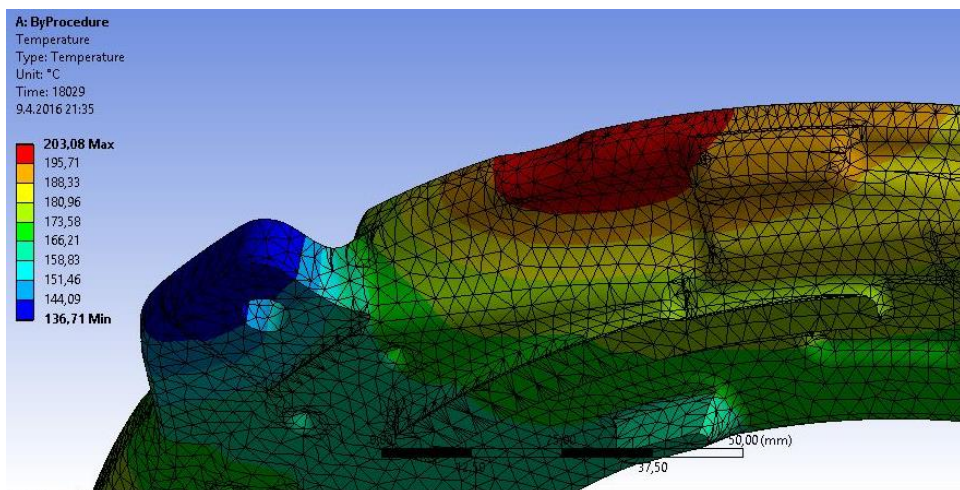

Figure 3.14. Peak Temperature area close view

3.2. Over Shock Test Outputs Comparison for FEA & Experimental Study

As mentioned in previous sections experimental case studies are carried out using test rigs described above. Experimental results of the clutch part show that crack location is defined as a risky area for possible crack deformations. It is also seen at the same area by FEA result. The comparison of experimental and FEA results are given in Figure 3.14.

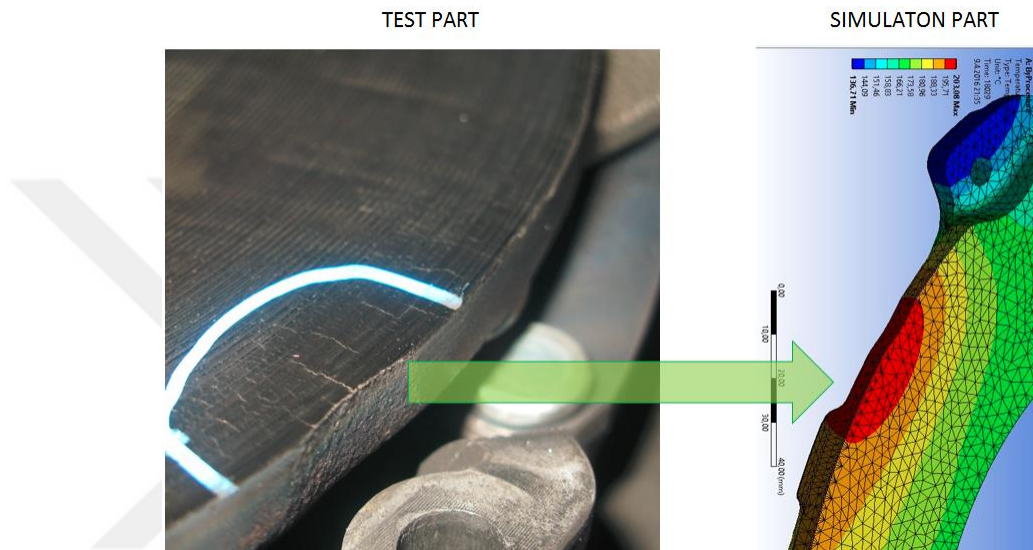

Figure 3.15. Comparison output of FEA and experimental study

Despite the crack, location of experimental part is same with simulation result, maximum temperature results obtained FEA and experimental study have significant difference as seen Figure 3.15

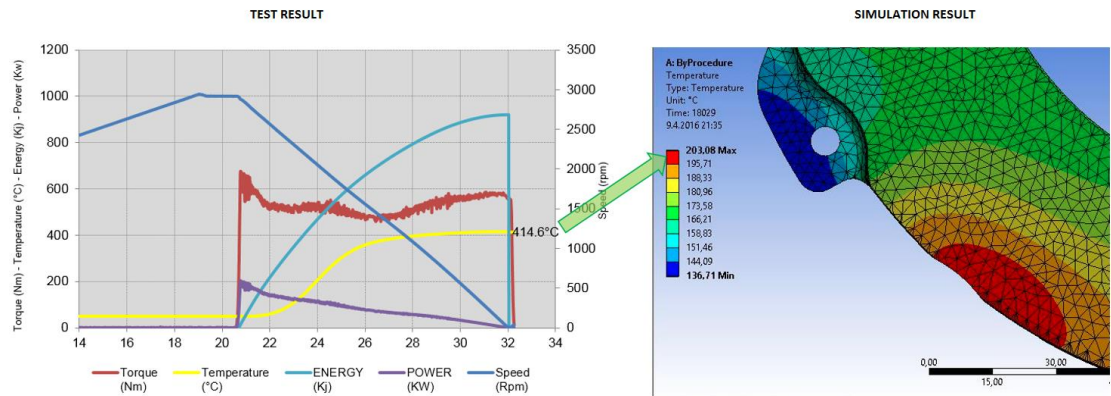

Figure 3.16. Comparison of maximum temperature generated from FEA and experimental study

As seen above figures, maximum temperature during experimental study is 414, 6°C but FEA result is 203,08°C. Gap between two study is 211.52°C and not acceptable. It must be achieved that FEA result have to be safer than experimental study to provide best estimation for design, material etc.

Experimental outputs and FEA inputs were inspected/compared to be able to find reason of difference of high temperature. Difference detected at slippage time. While slippage time is output of experimental study, it is input of FEA with below theoretical calculation.

$$T_p = (I \times w) / (2 \times \mu \times F_{axial} \times R) \quad (3.2)$$

I: Inertia of bench during braking [kg m²]

w: Angular velocity [rad / sn]

μ : Friction coefficient

Faxial: Clamp Load [N]

R: Mean contact radius

According to theoretical calculation T_p found as 9,3 sn and accepted constant during FEA but T_p is not constant output of experimental test. It's average is 13,3 sn during test and has tendency to increase during test as seen in Figure 3.16.

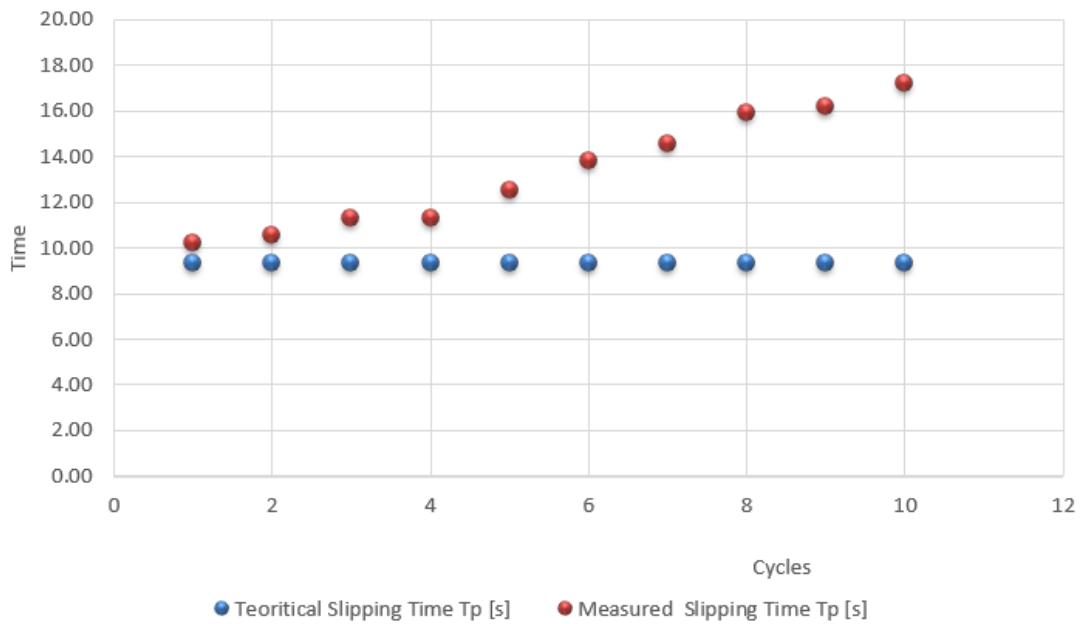

Figure 3.17. Slipping time comparison between FEA and experimental study

There are mainly two reasons, which are decreasing and reason to slipping time (T_p) increase during experimental study;

- Friction coefficient: It is not constant during test. It is has tendency to decrease under temperature
- Clamp Load: Hysteresis between clamp load curves are increase due to wear at inner components and reason the decrease nominal clamp load

3.2.1. Over Shock Test Outputs Comparison for FEA & Experimental Study

Slipping time (T_p) does not considered as constant during FEA analysis because dynamic conditions have effect on friction coefficient, clamp load etc. Assumption must be done by using experimental studies to increase slipping time for each cycles. Increase at slipping time is the reason for the high temperature distribution on friction surfaces. In this study, correction factor, which is calculated by experimental and theoretical slipping time ratios, is given in Table 2. They are used to apply each cycle of FEA.

Table 3.1. Correction Factor Table for slipping time

Cycle Number	Teoritical Slipping Time	Experimental Slipping Time	Correction Factor
1	9.30	10.19	1.10
2	9.30	10.55	1.13
3	9.30	11.29	1.21
4	9.30	11.31	1.22
5	9.30	12.49	1.34
6	9.30	13.78	1.48
7	9.30	14.545	1.56
8	9.30	15.94	1.71
9	9.30	16.19	1.74
10	9.30	17.22	1.85

FEA is updated and re-run by using above factors for each cycles and result found as shown in Figure 3.17.

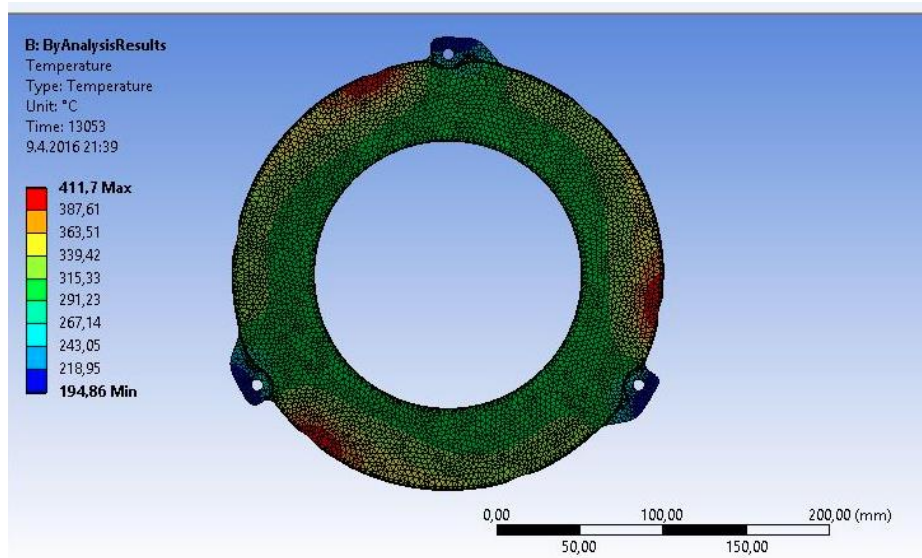

Figure 3.18. FEA analysis with updated slipping time using correction factors

Maximum temperature at friction surface compared with updated FEA result and max temperature outputs are close the each other as seen in Figure 3.19.

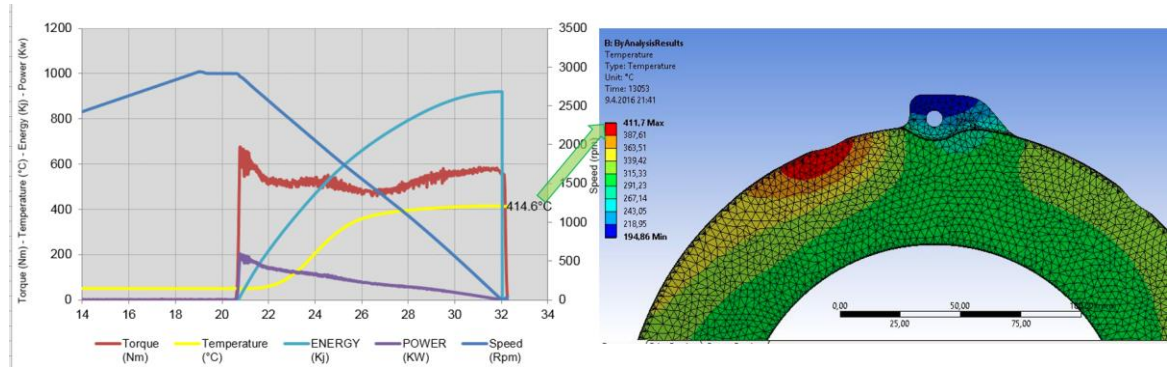

Figure 3.19. Comparison of maximum temperature generated from updated FEA and experimental study

It is seen that maximum temperature during experimental study is 414, 6°C and updated FEA result is 411,7°C. Correlation between experimental and FEA results is very low as being a difference of 2,9 °C, it means that 99 percent is a good value for correlation and it is negligible by using correction factor.

3.3. Hill Start Thermal Validation Tests

Hill start test is verifying the the thermal capacity of a clutch; qualify an adaptation or a quality of facing. Due to the difference between the engine torque and the resistance torque, slipping occurs, and heat energy is generated. The thermal energy heats up the frictional components. The dissipated energy heats the air within the clutch housing, and the clutch housing in return (Kocabas 2014 Simulation of the Clutch Hill Start Test).

$$T = NR_m \mu F_a$$

Number of sliding surfaces
 Transmitted torque from the engine
 Clamping load
 Friction coefficient of the clutch linings
 Clutch mean radius

Figure 3.20. Transmitted torque calculation

$$\tau_{driv} = \left[I_{trans1} + \frac{I_{trans2}}{R_2^2} + \frac{I_{dsh}}{R_1^2} + \frac{I_{axl}}{R_d^2 R_t^2} + \frac{M_{veh} r_{whl}^2}{R_d^2 R_t^2} \right] \frac{d\omega_{drv}}{dt} + \left[\frac{F_{aer} + F_{rol} + F_{grd}}{R_d R_t} \right] r_{whl}$$

Resistance torque τ_{driv} is calculated based on Inertia, Transmission ratio, Vehicle mass, Angular speed of input shaft, Final drive ratio, and Forces (aero, rolling, grade) acting on the wheel's dynamic radius.

Figure 3.21. Resistance torque calculation

3.3.1 Hill Start Experimental Bench Test Study

The sloped road movement of the vehicle in the hill start test cannot be simulated on the test bench. However, since the objective here is to investigate the thermal effect on the plate surface during torque transmission in the vehicle on a slope, the hill start condition can be simulated on the bench, taking into account the previously determined energy levels on the vehicle. Previously measured energy levels on vehicle at different slopes are used as input of bench test. Similar approach was performed during hill start bench test with over-shock thermal test. E (kJ) was used as an input and calculated other needed parameters for bench test.

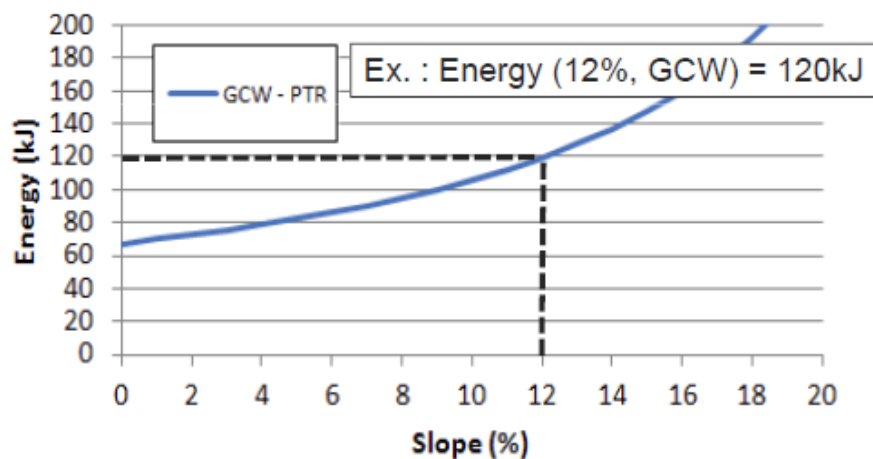

Figure 3.22. An example study for Energy (kJ) versus Slope Study (Valeo Training Document)

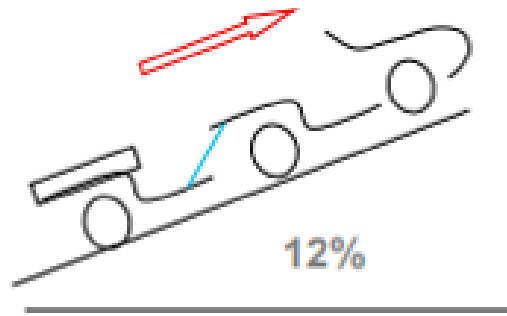

Figure 3.23. Bench test simulation hill start (TÜV) with same kind of energy

Bench test simulation was performed with below phases ,

Phase 0 ; 20 cycles with A KJ energy Level (Energy of %12 Slope)

Phase 1 ; 1 cycles with 1,3 X A KJ energy Level (Energy of %16 Slope)

Phase 2 ; 20 cycles with A KJ energy Level (Energy of %12 Slope)

Phase 3 ; 20 cycles with A KJ energy Level (Energy of %12 Slope)

KJ values are not given by numerical here because of confidential of data but it is coming as ready data by OEM. It is calculated by considering below vehicle weights, FDR and other parameters.

- **GCW: Gross Combined Weight** = Max vehicle weight + trailer.

- **GVW: Gross Vehicle Weight** = Max vehicle weight without trailer.

- **CVW (in French: PV): Curb Vehicle Weight** = Vehicle weight with all fill up without passenger and without loads

During the test clutch housing temperature mustn't exceed 160C. Pressure Plate temperature also needs to be recorded as same as thermal over shock bench test.

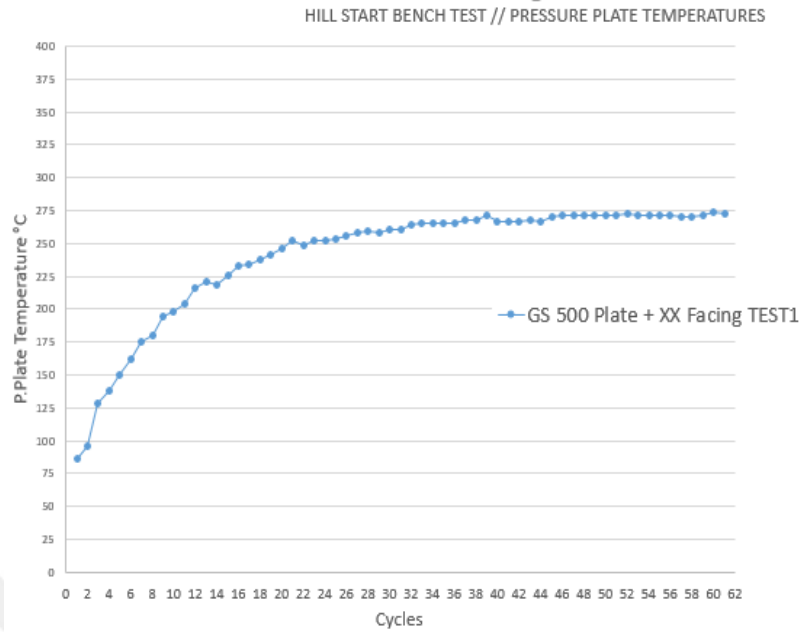

Figure 3.24. Experimental hill start test with GS500 p.plate material

Bench test is giving all recorded parameters as output of test. Surface temperature during test was visualizes as above Figure 3.22. Max p.plate surface temperature was recorded as 275 °C on this current experimental study.

3.3.2 Hill Start FEA Study

During FEA simulation of hill start bench test, similar approach was performed with over-shock thermal FEA study. The remarkable point between the two tests (Hill start test and Over shock test) is the energy levels used as input. Energy level of hill start test is less severe than over shock thermal test.

Theoretically, temperatures on the pressure plate surface of hill start test will be lower than over shock test due to the low energy input for hill start test.

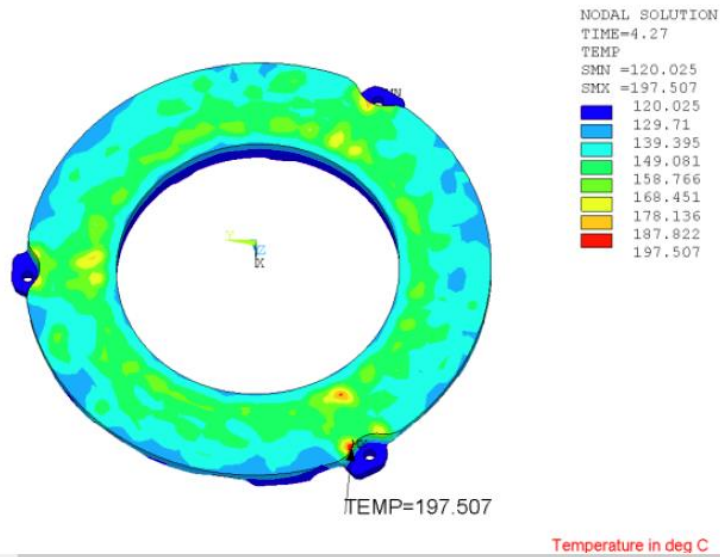

Figure 3.25. Hill Start Test FEA output

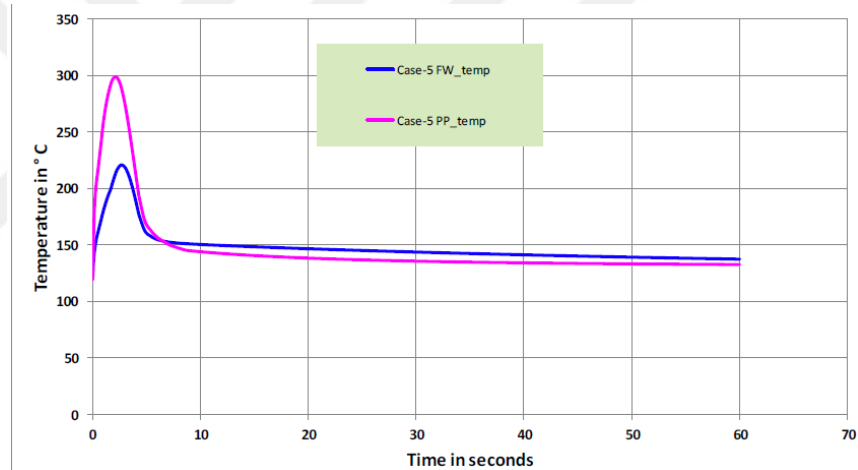

Figure 3.26. Hill Start Test FEA outputs as Temperature vs Time

FEA simulation was performed by considering previous study for over-shock thermal test. Temperature increase was visualised as above graph versus timing. Maximum temperature was recorded as 300°C on pressure plate surface.

3.3.3 Comparative Hill Start Bench Test on FEA study

Bench test and FEA result were compared with each others. During bench test maximum temperature on pressure plate was recorded as 275°C while it is found as 300°C with FEA study.

The temperature of the plate surface obtained from FEA analysis was higher than the temperature obtained by experimental study. When the obtained temperature values are taken into consideration, the FEA value is 1.1 times higher than the experimental study. This difference is within acceptable limits. The higher the FEA value is providing more secure the boundary for the designer so considering the FEA value in the design studies will lead to a more reliable product and will not be reason weakness design .

Obtained results are close the each others. FEA study results is 1,09 times more than bench test result. This is inside the acceptance criteria and FEA result is creating more secure border for designer by giving.

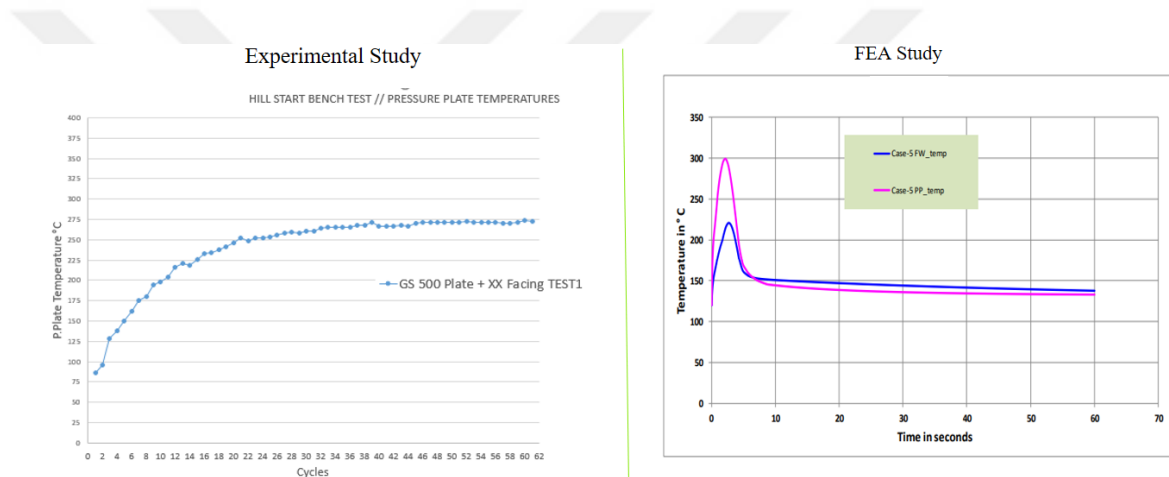

Figure 3.27. Hill Start Test FEA outputs as Temperature vs Time

As seen above comparison figure, Recorded max temp°C is 275 °C on plate surface during experimental study while it was measured max temp°C is 300 °C (purple curve) on plate surface during FEA study.

This work is no longer required, the correction factor determined for the FEM analysis on experimental basis. The main reasons for this can be summarized as follows.

The FEA result was approximately 9% higher than the experimental study. In this case, the designer will design the product within reliable limits only if it operates based on the FEA result. In case of the opposite situation; If the maximum temperature values obtained

in the experimental study gave higher results than the temperature values obtained by the FEA study, the reliability of the design could be a problem when the designer made the design based on the FEA result.

Thanks to low Energy input for hill start FEA study, there was no significant Theoretical Slipping time (T_p) & experimental slipping time. For that reason there is no significant.

3.4. P.Plate Material Effect Searching on P.Plate Strength

The pressure plate, which is examined by this study, is produced by casting production method. The casting process is achieved by the filling of the liquid metal into the molds with the cavity having the shape of the part to be produced. Before casting, the metal is melted and brought to the casting temperature. The metal filled into the mold starts to cool down and starts to solidify when the temperature decreases to a certain value. The dimensions of the mould cavity should be larger than the part to be obtained. It is determined by the specific properties of the metal poured into the mold, such as yield. In this way, size reductions during solidification and cooling are compensated. Casting part is called as raw part of clutch systems. It is needed additional process to be ready final assembly operation. This additional process is . In accordance with the system design, the parts that are machined are ready for final use.

The selection of the material used in the casting process requires an engineering approach. Besides the high strength of the material, cost is also important in terms of suitability for mass production.

In order to decide the material selection, the performance of the products with different material in thermal tests were compared thanks to this thesis study. Vermicular Cast Iron (GV300) and Nodular Cast Iron (GS500) were used for comparison tests.

A comparison between the cast iron with vermicular graphite and that with nodular graphite gives just opposite results as studied by E. Guzika , S. Dzikb. The cast iron with vermicular graphite is an excellent engineering material, taking an intermediate position

between the high-performance inoculated cast iron with flake graphite and ductile iron with nodular graphite (ductile cast iron). The solidification and structure of iron castings in as-cast condition depend on the chemical composition of cast iron and on some technological factors which control the physical and chemical condition of liquid metal and the casting cooling rate in foundry mould. Speaking briefly, the technology of casting fabrication consists in making proper choice of the metal chemical composition and of the temperature of its overheating and pouring, in designing the best casting configuration and dimensions of mould cavity, and in selecting the type of moulding material. (by E. Guzika , S. Dzikb 2009). Below figure 3.17 is providing general advantages among the these material.

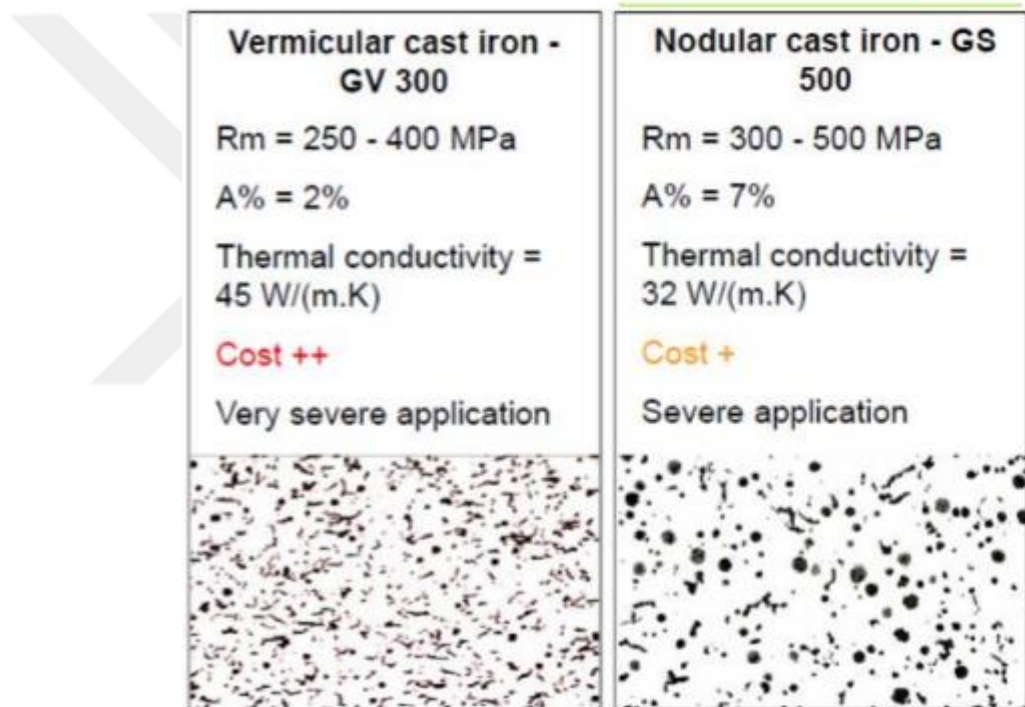

Figure 3.28. Comparison of GV 300 and GS 500 (Valeo Cast Iron Guide)

As seen above figure 3.17, GV 300 vermicular cast iron have higher thermal conductivity than GS500. Experimental thermal test were performed to compare plate surface temperatures with same conditions for both materials. Hill start bench test conditions were used to evaluate material effect on p.plate strength.

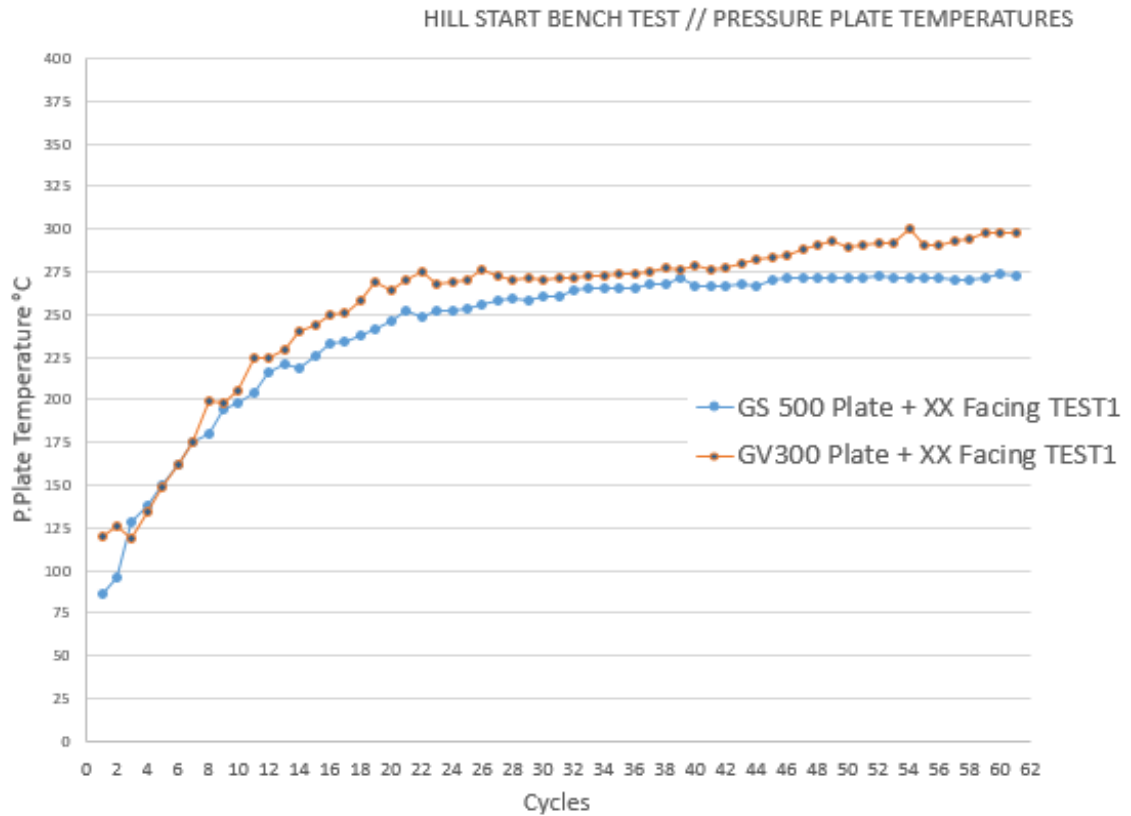

Figure 3.29. Experimental Test results for GV300 and GS 500 Material

Despite GV 300 vermicular cast iron have higher thermal conductivity than GS500 Nodular cast iron as seen figure 3.26, It has no higher temperature advantage than GS500 as output of experimental study. Temperature values on plate surface are very close for both material during test as indicated Figure 3.27

According to experimental results, GS500 material has both lower plate surface temperature and is more advantageous in terms of cost. GS500 is chosen as more convenient part as p.plate material.

3.5. Facing Friction Material Effect Searching on P.Plate Strength

Clutch facings can be manufactured from a range of materials depending on application and some of the most common are asbestos, woven fibers such as Kevlar or aramid and ceramic materials. As with disc brake pads and other clutch materials, the materials used in clutch facings need to be durable. The process of engaging and disengaging drive shafts

involves the transfer of kinetic energy into heat energy; therefore clutch facings need to be able to endure the tension of the process as well as the high temperatures which will be reached. Clutch facings are used in marine engines, heavy duty truck and lightweight vehicle engines as well as power presses, friction blocks and a number of industrial applications. The smooth and stable performance of many engines can be attributed to the existence of a quality clutch facing (<https://www.frictionmaterials.com/clutch-facings-2/>)



Figure 3.30. Valeo Organic Facings (Valeo Technical Instruction for HEC)

In this study, Facing (lining) material effect on p.plate thermal strength was investigated. Facings have a significant effect on torque transmission. Transmitted torque could be formulated as below,

Torque = Mean Radius x Clamp Load x μ (facing friction coefficient) x Nb facing surface

μ is directly linked of facing composition and must be stable during torque transmission. Fluctuation on μ under thermal condition could lead slipping effect which is creating excessive thermal load both on facing and p.plate surface

Different facing materials are coded as XX and XZ facing due confidential data. Experimental studies were done by using XX facing & XZ facing on same p.plate materiel by using GV300 p.plate material (worst condition).

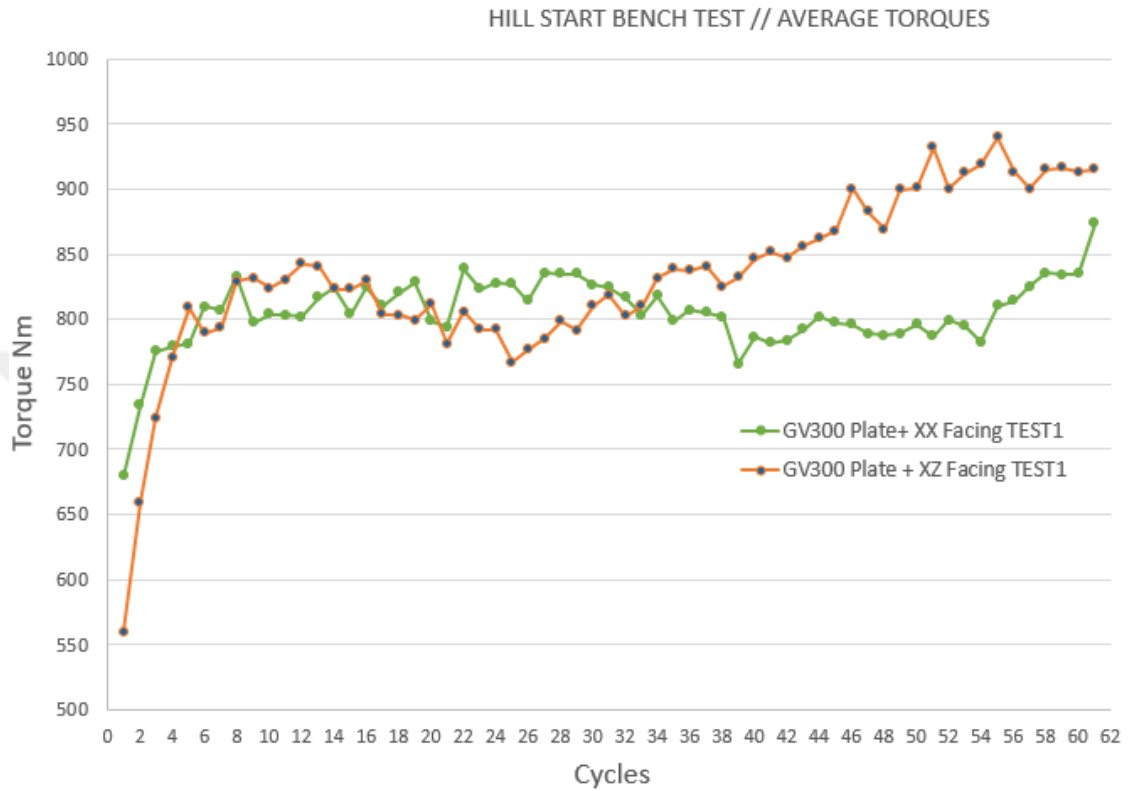

Figure 3.31. Hill Start Bench Test Average Torque Measurements

Facing with XZ composition has positive contributor for average torque transmission after 30 cycles as seen hill start bench test results. Average torque values are close to each other till 30 cycle (engagement). Facing XX was entered an early regular regime and showed a steady trend in torque transmission. Figure 3.31

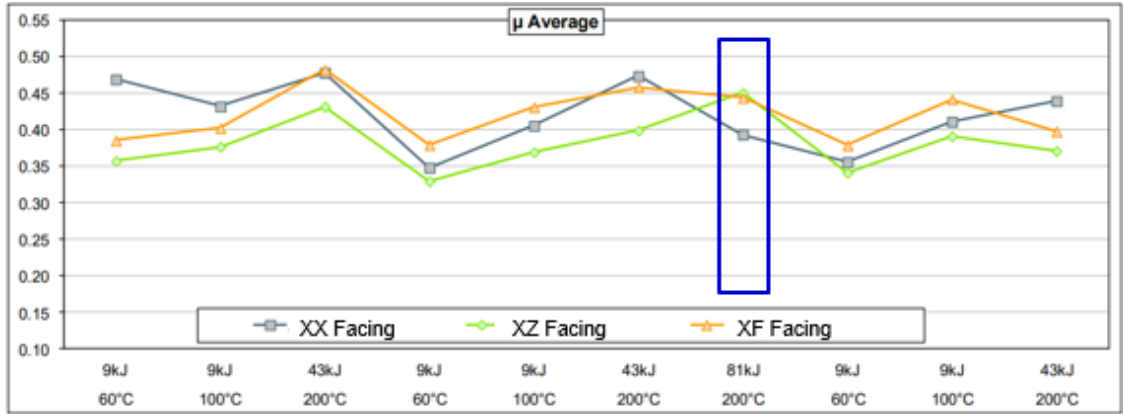

Figure 3.32. Single Facing μ measurement under thermal condition (Valeo μ measurement)

The following above study explains the difference in torque transmission among the different facing materials. 3 different facing composition μ measurement were done on different thermal conditions. In here only XX facing and XZ facing was considered on hill start bench test to simplify study and also XF coded facing has cost disadvantage despite it has more μ than XZ coded facing.

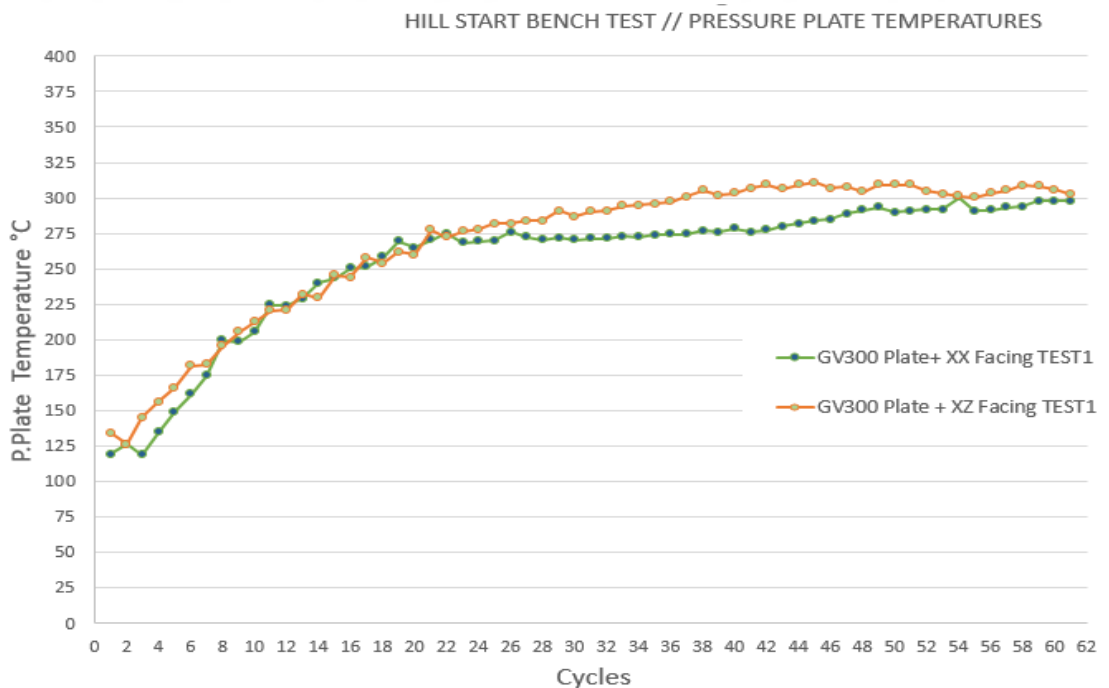

Figure 3.33. Hill Start Bench Test P. Plate Temperature Measurement

4. RESULTS AND DISCUSSION

The automotive sector, which has shown great progress in recent years, is in great competition in terms of the comfort and reliability it offers to the users. They want robust design from their suppliers every day in order to protect their brand image against the errors that will occur in vehicle subsystems. Depending on this demand, the manufacturers of automotive supply industry are constantly striving to improve their products by following the continuous improvement method in their products. However, cost is an important constraint when making these improvements. The main objective is to make the improvements at the optimum level and not to increase the product cost.

In this thesis, the strength of the engineering clutch plates was examined. Both experimental studies and FEA were performed. The results of the experimental studies were compared with the results obtained from FEA and the improvement suggestions were made for the better results of the FEA study. The possibility of performing experimental studies in this thesis clearly distinguishes the study from the studies in other literature. The full size bench test, which is used in the experimental tests, is specially designed for the simulation of thermal conditions and the software can monitor many parameters instantly.

4.1. Over –shock Thermal Test

Experimental over-shock thermal test result was not inline the FEA study Experimental test results shows that pressure plate is exposed higher thermal load than FEA calculation. Slipping time on experimental study is output of bench test while it was input of FEA study.

$$T_p = (I \times w) / (2 \times \mu \times F_{axial} \times R)$$

As theoretic calculation T_p found as 9,3 sec and accepted constant during FEA but T_p is not constant output of experimental test. It's changing under thermal condition. Because

friction coefficient is not constant under thermal condition and has a reduce tendency by temperature increase as indicated below study.

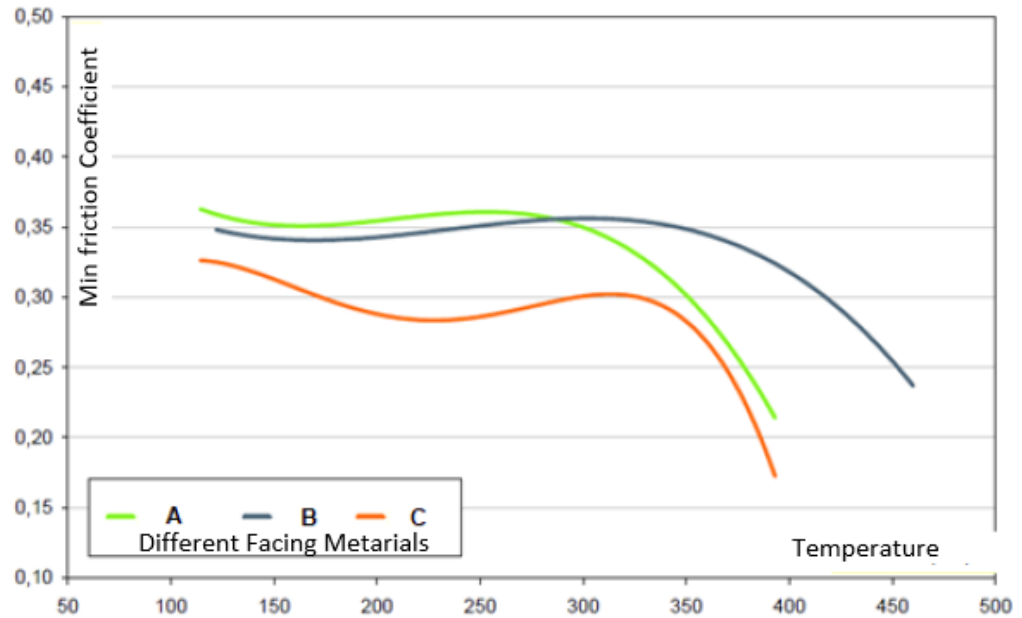

Figure 4.1. Friction Coefficient (μ) change versus temperature (Valeo Tests)

As shown in figure4.1, over 300°C, seen significant decrease on min friction coefficient. Therefore, thermal loads, which cause over 300 °C on the p.plate surface, will cause wrong results in FEA simulation by μ sharply decrease over 300 °C.

In this study, over- shock thermal test is leading high thermal load on p.plate surface and plate surface was reached over 300 °C. For that reason, FEA calculation is not able to catch same result of experimental study. FEA study was re-performed by Applying correction factor which was obtained from experimental study. for that reason the correction factor was applied and re-analysis than with FEA with dynamic slipping time (T_p). Based on the experimental studies, a more accurate simulation of the temperature distribution is provided by the finite element analysis through improved inputs. Analysis with the experimental test results provides better understanding of the thermal properties of the clutch.

4.2. Hill Start Thermal Test

In the hill start thermal experimental test, the temperature on the plate surface was measured less than 300 °C. In parallel, FEA analysis was performed by using theoretical slipping time. The results of the two studies were approximately similar and the temperature values obtained from the FEA were approximately 9% higher than experimental test result so FEA results of hill start test are inside the safe zone. Designer could take account FEA study during design improvement study. This was not cause any doubt on final product. If the temperature values obtained in the FEA were less than the experimentally obtained temperature values, it would be misleading the designer to apply thermal validation directly on the product considering with FEA results. The friction coefficient below 300 ° C does not exhibit excessive variation. Therefore, it does not affect the theoretical slipping calculation. There is no need define any correction factor for FEA analysis by taking reference of experimental study. Because both study results are very close the each other's with above explained condition.

Table 4.1. Max Pressure Plate Temperature

No	Work Condition	Max Temperature on p.plate surface	Correction on Tp (Y/N)
1	Over -shock thermal bench test	414 °C	N
2	Over -shock thermal FEA simulation	203 °C	Y
3	Over -shock thermal FEA simulation	411 °C	N
4	Hill Start thermal bench test	275 °C	N
5	Hill Start thermal FEA simulation	300 °C	N

The thermal analysis is presented through the experimental test results to provide better FEA process for understanding of the automotive clutch thermal characteristics. The present approach can be applied only to have an initial knowledge about the clutch system design in short time. This will help to apply more efficient design procedure for clutch systems. After the initial design stage results, more complicated modelling and analysis (assembled model parts together with their strict boundary conditions and restrictions) must be carried out to achieve final outlines of the clutch system based on initial analysis results. The designer can get benefits by utilising the results obtained from the initial

study, which is presented in this study. This will prevent costly experimental and computational studies during the clutch design.

It can be concluded that thermal validation of clutch frictional parts for both experimental analysis and FEA is essential to determine thermal capacity and make design actions in the early stage of clutch design process. This will help to reduce experimental work cost and time in design validation process. It is seen that FEA must have feed back from experimental approach to determine thermal capacity and make design actions in the early stage of clutch design process to achieve reduced cost and time.

4.3. P.plate Material Change

In order to reduce the temperature to which the plate surface is exposed, prototype plates have been produced from different plate materials. Using these prototype materials, hill start bench test was performed under the same thermal conditions.

Vermicular Cast Iron (GV300) and Nodular Cast Iron (GS500) were used to produce prototype plates for comparison tests. Vermicular cast iron has higher thermal conductivity than Nodular Cast Iron so Vermicular Cast Iron is used at more severe application with higher cost than GS500 Material. Bench test results show that there is no significant improvement on surface temperature by changing material GS500 to GV300.

In addition, Nodular Cast Iron material (GS500) has similar thermal performance based on bench test result while it has cost advantage.

4.4. Facing Material Change

Facings are products that have a significant effect on torque transmission. Customers require the high efficiency during torque transmission. Parts from different lining materials were tested to meet customer requirements and increase efficiency in torque transmission.

It was observed by experimental test that the average torque transmission values increased after a certain cycle due to the change of lining material while it was have similar temperature value on pressure plate surface. During facing material definition on disc assembly, friction coefficient variation under high temperature must be examined.



5. CONCLUSION

The defect mode that occurs in most of the complained parts collected from the field under warranty is due to thermal effects. When the temperature of the friction surface increases to a critical value, it may make cracks on the pressure plates surfaces. Casting parts are more sensitive against to crack on surface or internal structure. Because crack on the casting can be enlarged by subsequent thermal effects, bringing the casting to a level where it could burst under the vehicle rpm.

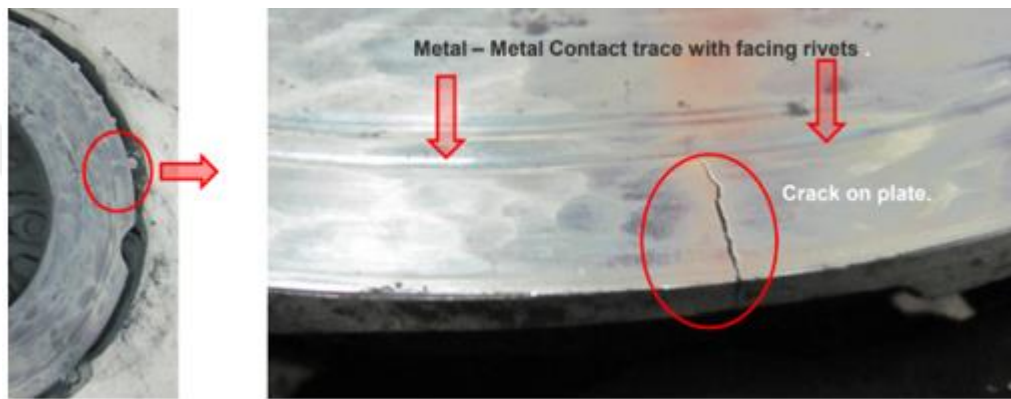

Figure 5.1 Excessive thermal loaded p.plate with crack surface

Although previous studies have examined the problem theoretically, the relationship with experimental data has not been established in real terms. In this study, it is revealed that the theoretical data should be verified with experimental data and if necessary, the theoretical data should be updated by experimental data support. Therefore, one of the objectives of the study presented in this thesis is to examine the data obtained experimentally and allow the improvement of FEA inputs.

During the comparisons among the experimental and FEA results, it was found that there were large differences between experimental and FEA outputs for the over shock thermal test. When the reasons of this difference are examined, it is seen that plate surface temperatures exceed 300 °C during over-shock thermal test. At temperatures above 300 ° C, the friction coefficient value of the lining material has decreased sharply as a measurement result of friction coefficient under thermal condition. From this fact, it is seen that it is not enough to obtain a constant T_p (slipping time) for FEA and it is

necessary to increase T_p gradually in FEA analysis by considering friction coefficient reduce under temperature.

The clutch plate design is accepted as constant and the effect of material changes also was investigated in order to reduce the thermal effect on the pressure plate surface. Prototypes were prepared by changing facing and p.plate materials. The prototypes were prepared from vermicular Cast Iron and Nodular Cast Iron (GS500). Theoretical information shows that the thermal performance Vermicular Cast Iron better than Nodular Cast Iron but according experimental test results, the temperatures on the plate surface were very close for both cast iron materials. Therefore, it has been shown that the GS 500 is less expensive material than the GV300 and this makes GS500 more preferable than GV300.

In lining material change, the effect of lining material on torque transmission was investigated by using 2 different materials. The test results of the lining materials shows that the lining tested with XZ code transmits higher average torque than XX coded facing material. It is seen that the temperatures formed on the plate surface are at the similar for both facing material so study result could be concluded as facing XZ code increased the average torque values and did not create an extra temperature effect on the plate surface.

REFERENCES

- Abdullah, O., Schlattmann, J. (2016).** Thermal behavior of friction clutch disc based on uniform pressure and uniform wear assumptions. *Friction*, 4,3: 228-237
- Abdullah, O., Schlattmann, J. (2014)** An Investigation of Heat Generation Due To Friction Using Finite Element Method. SAE Technical Paper 2014-01-0954.
- Abdullah, O.I., Schlattmann, J., Majeed, M.H., Sabri, L.A. (2018).** The temperatures distributions of a single-disc clutches using heat partitioning and total heat generated approaches. *Case studies in Thermal Engineering*, 11: 43-54.
- Adamowicz, A., Grzes, P. (2013)** Finite element analysis of thermal stresses in a pad-disc brake system (a review). *Acta Mechanica et Automatica*, vol.7 no.4.
- Fu, H., Fu, L., Liu, A.P., Zhang, G.L. (2010).** Finite Element Analysis of temperature field of clutch in Tunnel Boring Machin. *2010 WASE International Conference on Information Engineering*, IEEE Computer Society: 166-169.
- Glodová, I., Lipták, T., Bocko, J. (2014)** Usage of finite element method for motion and thermal analysis of a specific object in SolidWorks environment. *Procedia Engineering* 96: 131 – 135.
- Güneş, F.E. (2015)** Thermal modelling and simulation of dry friction clutches in heavy duty trucks. *MSc Thesis*, İTÜ, Mechatronics Engineering Department, İstanbul, Türkiye.
- Minereau, H. (1988).** PhD Thesis, Contribution a letude des transferts termiques dans L'embrayage, Mecanique Industrielle Conservatoire National des Arts et Metiers,1988, Paris, France.
- Purohit, R., Khitoliya, P., Koli, D.K. (2014)** “Design and Finite Element Analysis of an Automotive Clutch Assembly”. *Procedia Materials Science*, 6, pp. 490 – 502.
- Valeo (2014)**, Power Train University Training Presentation Document
- Wang, Q.T., Zhu, M.T., Liu, X.L. (2014).** Coupling Heat Structure Analysis of the Clutch Pressure Plate in Vehicle Overloaded Start Procession. *Sensors & Transducers*, Vol. 182, Issue 11: 156-161
- Zhao, J., Chen, Z., Yang, H., Yi, Y.B. (2016)** Finite element analysis of thermal buckling in automotive clutch plates”, *Journal of Thermal Stresses*, 39 (1): 77-89

RESUME

Name Surname : Tolga RAHAT

Place and Date of Birth : BURSA / 1990

Foreign Languages : English

Education Status

High School : Bursa Cumhuriyet Anadolu Lisesi / 2008

Bachelor's : Yıldız Teknik Üniversitesi Makine Fakültesi

: Makine Mühendisliği / 2013

Work Experience : Valeo Otomotiv San. A.Ş (2014–Devam Ediyor)

Contact(e-posta) : tolgarht@gmail.com