

STRATEGIES AND DIFFICULTIES IN SOLVING SPATIAL
VISUALIZATION PROBLEMS: A CASE STUDY WITH ADULTS

A THESIS SUBMITTED TO
THE GRADUATE SCHOOL OF NATURAL AND APPLIED SCIENCES
OF
MIDDLE EAST TECHNICAL UNIVERSITY

BY

EMİNE BANU KAYHAN

IN PARTIAL FULFILLMENT OF THE REQUIREMENTS
FOR
THE DEGREE OF DOCTOR OF PHILISOPHY
IN
SECONDARY SCIENCE AND MATHEMATICS EDUCATION

MAY 2012

Approval of the thesis:

**STRATEGIES AND DIFFICULTIES IN SOLVING SPATIAL
VISUALIZATION PROBLEMS: A CASE STUDY WITH ADULTS**

submitted by **EMİNE BANU KAYHAN** in partial fulfillment of the requirements
for the degree of **Doctor of Philosophy in Secondary Science and Mathematics
Education Department, Middle East Technical University** by,

Prof. Dr. Canan Özgen
Dean, Graduate School of **Natural and Applied Sciences** _____

Prof. Dr. Ömer Geban
Head of Department, **Secondary Science and Math. Educ. Dept.** _____

Prof. Dr. Safure Bulut
Supervisor, **Secondary Science and Math. Educ. Dept., METU** _____

Examining Committee Members:

Prof. Dr. Ahmet Arıkan
Secondary Science and Math. Educ. Dept., Gazi University _____

Prof. Dr. Safure Bulut
Secondary Science and Math. Educ. Dept., METU _____

Assoc. Prof. Dr. Erdinç Çakıroğlu
Elementary Education Dept., METU _____

Assoc. Prof. Dr. Ayhan Kürşat Erbaş
Secondary Science and Math. Educ. Dept., METU _____

Assist. Prof. Dr. Ömer Faruk Özdemir
Secondary Science and Math. Educ. Dept., METU _____

Date: 08.05.2012

I hereby declare that all information in this document has been obtained and presented in accordance with academic rules and ethical conduct. I also declare that, as required by these rules and conduct, I have fully cited and referenced all materials and results that are not original to this work.

Name, Last name: Emine Banu Kayhan

Signature :

ABSTRACT

STRATEGIES AND DIFFICULTIES IN SOLVING SPATIAL VISUALIZATION PROBLEMS: A CASE STUDY WITH ADULTS

Kayhan, Emine Banu

Ph.D., Department of Secondary Science and Mathematics Education

Supervisor: Prof. Dr. Safure Bulut

May 2012, 203 pages

The purpose of the present study is to investigate the spatial strategies of adults and the difficulties they experience while solving spatial visualization problems. To achieve this purpose, a case study is conducted and the case of this study is the group of five adults studying secondary or elementary mathematics education in a public university in Ankara. Spatial Ability Test (SAT) and task based interviews are utilized to determine the participants' spatial abilities; and to interpret their strategies, and their difficulties in solving spatial visualization problems.

The present study reveals that, the participants' spatial strategies are mainly categorized as: *holistic*, *analytic* and *intermediate* strategies. Moreover, sub-strategies are defined; for holistic strategies; *mental rotation* and *mental manipulation* strategies; for analytic strategies, *key feature* and *counting* strategies; and for intermediate strategies, *partial rotation*, *partial manipulation* and *pattern-based* strategies. Additionally, for each sub-strategy different ways of using that strategy are defined. As an example when using mental manipulation strategy, participants use two different ways; *imagining the folding* and *imagining the sequence*. It is also concluded that when the strategies are selected, characteristics of the problems are important.

This study shows that the difficulties of the participants in solving spatial visualization problems can be mainly categorized as: *limited flexibility* and *inadequate proficiency*. The results of this study provides detailed descriptions of strategies and difficulties of adults in solving spatial visualization problems to be used in designing tools for assessment or development of spatial visualization ability.

Keywords: Spatial ability, spatial visualization, spatial strategies, adults, mathematics education.

ÖZ

UZAMSAL GÖRME PROBLEMLERİNİ ÇÖZERKEN KULLANILAN STRATEJİLER VE KARŞILAN ZORLUKLAR: YETİŞKİNLERLE BİR DURUM ÇALIŞMASI

Kayhan, Emine Banu

Doktora, Orta Öğretim Fen ve Matematik Alanları Eğitimi Bölümü

Tez Yöneticisi: Prof. Dr. Safure Bulut

Mayıs 2012, 203 sayfa

Bu çalışmanın amacı, yetişkinlerin uzamsal görme problemleri çözerken kullandıkları uzamsal stratejileri ve yaşadıkları zorlukları araştırmaktır. Bu amaca ulaşmak için durum çalışması uygulanmıştır ve çalışmada incelenen durum Ankara'da bir devlet üniversitesinde ortaöğretim veya ilköğretim matematik öğretmenliği eğitimi alan beş yetişkinden oluşan gruptur. Katılımcıların uzamsal yeteneklerini belirlemek ve uzamsal görme yeteneği problemleri çözmedeki stratejilerini ve zorluklarını açıklamak için Uzamsal Yetenek Testi (SAT) ve görev temelli görüşmeler kullanılmıştır.

Çalışmanın bulguları katılımcıların uzamsal stratejilerinin şu şekilde kategorize edildiğini ortaya çıkarmıştır; *bütünsel*, *analitik* ve *arada olan* stratejiler. Ayrıca alt stratejiler tanımlanmıştır; bütünsel stratejiler için, *zihinsel döndürme* ve *zihinsel manipülasyon*; analitik stratejiler için, *anahtar özellik* ve *sayma* ve arada olan stratejiler için, *kısmi döndürme*, *kısmi manipülasyon* ve *şablona dayalı* stratejiler. Bununla birlikte her alt strateji için, o stratejinin farklı kullanım yolları açıklanmıştır. Örneğin kısmi manipülasyon stratejisini kullanmada iki farklı yol vardır; *simetri kuralı* ve *kısmi katlama*. Bunlara ek olarak, strateji seçerken problemin özelliklerinin önemli olduğu sonucuna varılmıştır.

Bu çalışma göstermiştir ki katılımcıların uzamsal görme problemleri çözerken karşılaştıkları zorluklar iki ana sınıfa ayrılabilir; *sınırlı esneklik* ve *eksik yeterlilik*. Bu çalışmanın sonuçları, uzamsal görme yeteneğini ölçmek ve geliştirmek için araç tasarlamakta kullanılabilir üzere, yetişkinlerin uzamsal görme problemleri çözerken kullandıkları stratejiler ve yaşadıkları zorluklarla ilgili detaylı açıklamalar vermektedir.

Anahtar Kelimeler: Uzamsal yetenek, uzamsal görme, uzamsal stratejiler, yetişkinler, matematik eğitimi.

To my son Kuzey...

ACKNOWLEDGEMENTS

I would like to express my gratitude to my supervisor Prof. Dr. Safure BULUT for her interest, patience, encouragement and valuable guidance throughout my study.

Thanks to my committee members, Prof. Dr. Ahmet ARIKAN, Assoc. Prof. Dr. Erdinç ÇAKIROĞLU, Assoc. Prof. Dr. Ayhan Kürşat ERBAŞ and Assist. Prof. Dr. Ömer Faruk ÖZDEMİR for their valuable feedback and guidance.

Special thanks to my sister Burcu KAYHAN for her support, patience and encouragement throughout my life. Without your help I couldn't finish my research.

I want to express eternal gratitude to my mother Sıdıka KAYHAN for her endless love, trust and guidance throughout my life. Without her support, I would have never finished demanding period of writing this dissertation.

I want to express my thanks to my husband Ali Ekber KIRMAÇ for his endless love, patience, encouragement and morale support in everyday of our friendship.

And finally, I want to express my thanks to my son Kuzey for being in my life and his patience during my long and exhausting study.

TABLE OF CONTENTS

ABSTRACT.....	iv
ÖZ.....	vi
ACKNOWLEDGEMENT.....	ix
TABLE OF CONTENTS.....	x
LIST OF TABLES.....	xiii
LIST OF FIGURES.....	xiv
LIST OF ABBREVIATIONS.....	xvi
CHAPTERS	
1. INTRODUCTION.....	1
1.1. Research Questions.....	7
1.2. Definition of Terms.....	7
1.3. Significance of the Study.....	8
1.4. My Motivation for the Study.....	11
2. LITERATURE REVIEW.....	13
2.1. Spatial Ability.....	13
2.1.1. What is Spatial Ability.....	13
2.1.2. What is Spatial Visualization?.....	15
2.1.3. Importance of Spatial Ability.....	20
2.1.4. Development of Spatial Ability.....	25
2.2. Spatial Strategies.....	33
2.2.1. Classifications and Definitions of Spatial Strategies.....	33
2.2.2. Studies on Spatial Strategies.....	36
2.3. Summary.....	42
3. METHODOLOGY.....	46
3.1. Research Design.....	46
3.2. Participants of the Study.....	47
3.3. Data Sources.....	50

3.3.1. Spatial Ability Test.....	51
3.3.2.Task Based Interviews.....	53
3.4. The Overall Procedure.....	56
3.5. Data Analysis.....	57
3.5.1. Analysis of SAT.....	58
3.5.2. Analysis of Spatial Strategies of the Participants	59
3.5.3. Analysis of Difficulties of Participants in Solving Spatial Visualization Problems.....	60
3.6. Validity and Reliability of the Study.....	60
3.7. Assumptions and Limitations.....	62
3.7.1. Assumptions.....	62
3.7.2. Limitations.....	62
4. RESULTS AND CONCLUSIONS.....	63
4.1. Participants' Spatial Ability Test (SAT) Scores.....	64
4.2. Participants' Spatial Strategies.....	67
4.2.1. Holistic Strategies.....	69
4.2.1.1. Mental Rotation Strategy.....	69
4.2.1.2.Mental Manipulation Strategy.....	73
4.2.1.2.1. Imagining the Folding.....	73
4.2.1.2.2. Imagining the Sequence	75
4.2.2. Analytic Strategies.....	77
4.2.2.1. Key Feature Strategy.....	78
4.2.2.1.1. Comparing the Relative Positions.....	78
4.2.2.1.2. Comparing the Relative Distances.....	82
4.2.2.2. Counting Strategy.....	84
4.2.2.2.1. Counting the Number of Cubes.....	84
4.2.2.2.2. Computing the Number of Cubes.....	85
4.2.2.2.3. Using Drawing Techniques.....	87
4.2.3. Intermediate Strategies.....	88
4.2.3.1. Partial Rotation Strategy.....	89
4.2.3.2. Partial Manipulation Strategy.....	90

4.2.3.2.1. Symmetry Rule.....	90
4.2.3.2.2. Partial Folding.....	91
4.2.3.3. Pattern-Based Strategy.....	91
4.2.3.3.1. Abstracting the Figure.....	92
4.2.3.3.2. Painting.....	94
4.2.4. SAT Scores and Spatial Strategies of the Participants.....	97
4.3. Participants' Difficulties.....	116
4.3.1. Inadequate Proficiency.....	117
4.3.1.1. Inadequate Proficiency in Rotation Problems.....	117
4.3.1.2. In Manipulation Problems.....	120
4.3.1.3. In 2-D Drawing of 3-D Object Problems.....	122
4.3.2. Limited Flexibility.....	124
4.3.2.1. In Rotation Problems.....	125
4.3.2.2. In Manipulation Problems.....	127
4.3.2.3. In 2-D Drawing of 3-D Objects.....	129
4.4. Conclusions.....	133
5. DISCUSSIONS, IMPLICATIONS AND RECOMMENDATIONS...	141
5.1. Strategies Used in Solving Spatial Visualization Problems.....	141
5.2. Difficulties in Solving Spatial Visualization Problems.....	148
5.3. Implications.....	152
5.4. Recommendations for Further Research.....	154
5.5. Reflections about my Future Profession.....	155
REFERENCES.....	157
APPENDICES.....	169
A. SAMPLE QUESTIONS OF SAT.....	169
B. TASK-BASED INTERVIEWS.....	171
C. CODES OF THE TASK BASED INTERVIEWS.....	178
D. SAT RESULTS OF THE PARTICIPANTS.....	180
E. TRANSCRIPTIONS OF THE INTERVIEWS.....	183
VITA.....	203

LIST OF TABLES

TABLES

2.1. Chronology of Spatial Ability Research with Themes and Approach.....	21
3.1. The Participant Characteristics.....	50
3.2. Reliability Coefficients, Number of Questions, Total Scores and Durations for the Tests.....	52
3.3. Categories of Spatial Visualization Problems of Task Based Interviews..	55
4.1. The Scores of Participants in SAT.....	65
4.2. The Categorization and Number of Problems in the Three Task Based Interviews.....	68
4.3. The Number of the Repetition of the Strategies used by the Participants in the Three Task-Based Interviews.....	96
4.4. The Number of Repetition of Strategies Used in the Three Task-Based Interviews and; the Scores of Participants in SAT and the Three Task-Based Interviews.....	116
4.5. The Number Experienced Difficulties in Solving Spatial Visualization Problems during the Task-Based Interviews.....	132
D ₁ : SAT Results of P ₁	180
D ₂ : SAT Results of P ₂	181
D ₃ : SAT Results of P ₃	181
D ₄ : SAT Results of P ₄	182
D ₅ : SAT Results of P ₅	182

LIST OF FIGURES

FIGURES

2.1. The schema of Tartre (1990) taken from Sorby (1999).....	17
4.1. Card Rotation problem of the 1 st task-based interview.....	70
4.2.1 st Cube comparison problems of the 1 st task-based interview.....	71
4.3. 2 nd Cube comparison problems of the 1 st task-based interview.....	71
4.4. 3-D rotation problem of the 3 rd task-based interview.....	72
4.5. 1st Paper folding problem of the 1 st task-based interview.....	74
4.6. 3rd Paper folding problem of the 2 nd task-based interview.....	74
4.7. 2nd Paper folding problem of the 1 st task-based interview.....	75
4.8. 1 st Surface development problem of the 1 st task-based interview.....	76
4.9. Surface development problem of the 3 rd task-based interview.....	77
4.10.2 nd Card rotation problem of the 1 st task-based interview.....	79
4.11.1 st Card rotation problem of the 2 nd task-based interview.....	79
4.12.2 nd Surface development problem of the 2 nd task-based interview.....	81
4.13.2 nd Surface development problem of the 1 st task-based interview.....	81
4.14. 2 nd Card rotation problem of the 2 nd task-based interview.....	83
4.15. Orthographic drawing problem of the 2 nd task-based interview.....	84
4.16 . The orthographic drawing of P ₂ in the 1 st task-based interview.....	85
4.17. Isometric drawing problem of the 2 nd task-based interview.....	86
4.18. P ₅ wrote the number of cubes on the top view.....	87
4.19. The isometric drawing of P ₃ in the 2 nd task-based interview.....	88
4.20. Orthographic drawing problem of the 3 rd task-based interview.....	92
4.21. Problem 18: Isometric drawing problem.....	93
4.22. Isometric Drawing of P ₁ in the 2 nd task-based interview.....	94
4.23. 1 st Cube comparison problem of the 2 nd task-based interview.....	99

4.24. P ₁ wrote the number of cubes on the top view.....	100
4.25. 3rd. Card rotation problem of the 2 nd task based interview.....	101
4.26 . The orthographic drawing of P ₂	103
4.27. The isometric drawings of P ₂ in the 1 st and 3 rd task-based interviews...104	
4.28. Orthographic Drawing of P ₄ in the 2 nd task-based interview.....	110
4.29. Isometric Drawing of P ₄ in 2 nd task-based interview.....	111
4.30. P ₅ drew the folded edges and took symmetry.....	113
4.31. P ₅ wrote the number of cubes on the top view	114
4.32. The isometric drawing of P ₅ in the 3 rd task-based interview.....	115
4.33. 1st Card Rotation problem of the 1 st task-based interview.....	117
4.34. Problem 12: Card rotation problem	118
4.35. Problem1: Cube comparison problem.....	118
4.36. Problem11: Card rotation problem.....	119
4.37. Problem 8: Surface development problem.....	120
4.38. Problem 25: Surface development problem.....	121
4.39. Problem 18: Isometric drawing problem.....	123
4.40. Problem 13: Card rotation problem.....	125
4.41. Problem 1: Cube comparison problems.....	126
4.42. Problem 6: Paper folding problem.....	127
4.43. Problem 7: Surface development problem.....	128

LIST OF ABBREVIATIONS

CCT	Cube Comparison Test
CRT	Card Rotation Test
ELE	Elementary Education
MoNE	Ministry of National Education
NCTM	National Council of Teacher of Mathematics
PFT	Paper Folding Test
SAT	Spatial Ability Test
SDT	Surface Development Test
SSME	Secondary Science and Mathematics Education
BoE	Board of Education

CHAPTER 1

INTRODUCTION

In order to interpret, understand and appreciate our inherently geometric world, spatial understanding is necessary. From the first acknowledgement of spatial ability, it has been accepted as a necessary ability not only for our daily lives but also for many other areas such as arts, design, engineering, science, geometry and mathematics (Delialioğlu, 1999; Gardner, 1985; Gutierrez, 1996; Kayhan, 2005; Mohler, 2008; Olkun, 2003; Usiskin, 1987). McGee mentions that spatial visualization and orientation are highly correlated with success in a number of technical, vocational and occupational domains (1979). Yue (2006) also mentions that spatial ability is vital in some hot technologies such as geometric information systems, biomedical information technology and robotics. Psychologists were aware of the importance of visualization long time ago, and they have developed detailed theories to frame their work, and tools to observe and test individuals (Gutierrez, 1985, pp.5).

There are slightly different definitions and classifications of spatial ability in the literature. According to McGee (1979) the factor analytic studies reveal that spatial ability has distinct factors. Research studies provide consistent support for the existence of at least two spatial abilities; visualization and orientation. Spatial visualization involves the ability to mentally rotate, manipulate, and twist two- and three-dimensional stimulus objects. On the other hand spatial orientation is the ability to remain unconfused by the changing orientation in which a spatial configuration may be presented (McGee, 1979). According to the definitions and

categorizations of McGee on spatial ability, the present study focuses on the spatial visualization factor.

Since 1940s mathematics educators and researchers have been studying the relation of spatial ability, geometry and mathematics. As Gutierrez (1985) mentions geometry is accepted as the origin of visualization in mathematics. Additionally, the usefulness of visualization and graphical representations in the teaching of mathematics is being recognized by most of the mathematics educators and teacher of mathematics (Gutierrez, 1985). Moreover, Presmeg (2000) expresses that spatial visualization is one of the primary abilities that are important in learning and doing mathematics since mathematics is a subject that has diagrams, tables, spatial arrangements of signifiers such as symbols, and other inscriptions. The findings of the previous research studies confirm these ideas and the results show that there is positive relation between the spatial visualization ability and the mathematics performance (Herskowitz, 1989; Hodgson, 1996; Presmeg, 1997; Usiskin, 1987).

The acknowledgement of the importance of spatial ability makes the researchers start to study on how to develop this ability. Especially positive relation between mathematics and spatial ability attracts the attention of mathematics educators on the development of spatial ability. Various research studies have shown that there is a positive relationship between spatial training and spatial ability development. In other words, students' spatial ability can be developed through training if appropriate materials are used (e.g., Ben-Chaim et al., 1985; Clements & Battista, 1992; Çakmak, 2009; Gutierrez, 1985; Kayhan, 2005; Olkun, 2003). The findings of research studies about spatial ability help curriculum developers become aware of the issue and development of spatial ability has become an important part of mathematics curricula. National Council of Teachers of Mathematics (NCTM) impresses the importance of spatial visualization ability by including spatial skills in the US curriculum standards for primary and secondary school geometry

education. It is stated that rather than a separate subject, spatial ability of students should be developed through all subjects of mathematics (NCTM, 2000). Moreover, published standards of NCTM for middle level mathematics teachers emphasizes that, teacher candidates should use spatial visualization to explore and analyze geometric shape, build and manipulate representations of two- and three-dimensional objects and apply transformation (NCTM, 2003). In the new elementary mathematics and secondary geometry curricula designed by Turkish Ministry of National Education (MoNE), the importance of spatial ability is also acknowledged and developing spatial ability of students is accepted as one of the main purposes of geometry education (MoNE, 2005, 2006, 2009, 2010, 2012). Additionally, in order to develop spatial ability of students, spatial activities and materials are introduced by Turkish Board of Education (BoE) (BoE, 2005).

When conducting studies on spatial ability, its relation with other areas and the effects of different factors on its development, the assessment of spatial ability has a vital importance. A lot of psychometric studies have been held to assess the spatial ability and different tools had been designed such as spatial ability test (SAT) (Ekstrom, 1976), Purdue spatial visualization test (PSVT) (Guay, 1976), mental rotation test (MRT) (Vandenberg & Kuse, 1978). However, when the thought processes in solving spatial problems are investigated, it is revealed that visual imagery is not the only way of solving spatial problems (Glück & Fitting, 2003). Here visual imagery is used as the processes of evoking or generating images which are not directly observed. Therefore, scores of individuals in spatial aptitude tests may not provide enough evidence to understand individuals' spatial abilities. To have a better understanding of spatial ability of people their thought processes should also be taken into consideration.

One way of investigating the thought process is accepted as analysis of the spatial strategies in solving spatial problems. Strategies are the observable manifestations of intelligence (Gitimu and Workman, 2007, pp.172). The previous studies show

that analysis of spatial strategies used by individuals while solving spatial problems or completing spatial tasks add important information to spatial test scores (Burin & Prieto, 2000; Eme & Marquer, 1999; Glück & Fitting, 2003; Gorgorio, 1998; Kyllonen et al., 1984). A strategy can be defined as one of several alternative methods for performing a particular cognitive task (Saczynski, Willis, & Schaie, 2002) and the decision of the strategy may depend on many internal and external factors. Therefore, in understanding the differences of people's spatial aptitudes, knowing their strategies plays a crucial role.

The reviewed literature suggests that individuals use various strategies while completing spatial tasks and different classifications of these strategies exist. One of the broadly used classification has two aspects; *holistic* and *analytic* (Glück & Fitting, 2003; Burin & Prieto, 2000; Eme & Marquer, 1999; Gorgorio, 1998). *Holistic* strategies involve the mental rotation or mental manipulation of the given stimulus object whereas *analytic* strategies involve representing and manipulating spatial information by reducing it into a format which has minimal visualization (Glück & Fitting, 2003; Burin & Prieto, 2000; Eme & Marquer, 1999; Gorgorio, 1998). On the other hand, these strategies are not mutually exclusive categories, they could be viewed as two poles of a continuum; and there are also *intermediate* strategies. As an example, while solving a spatial visualization problem which requires rotation as a mental process; if one imagines the rotation this is accepted as a holistic strategy. On the other hand if one tries to fix the positions of the elements of the rotated object and then control it with the test object, then it is analytic strategy. However, individuals may use strategies such as rotating parts of the rotated object, which could be accepted as a strategy between analytic and holistic; in other words an intermediate strategy. Gitumi and Workman (2007) mention that, in order to obtain a clearer understanding of spatial visualization ability; the spatial strategies of individuals should be detailed.

The studies on the spatial strategies of people conclude that analytic and intermediate strategies also help people to solve spatial visualization problems and have high scores in the ability tests (Glück & Fitting, 2003; Burin & Prieto, 2000; Eme & Marquer, 1999; Gorgorio, 1998). However, for the areas such as arts, engineering and design which require 2-D and 3-D manipulation and rotation, analytic strategies may not be enough. Such areas require mental visualization; therefore, it is important to analyze the strategies of people to understand the level of their spatial abilities in depth.

The decision of a particular strategy may depend on intrinsic and extrinsic factors. Individual differences in strategies that are used to perform a spatial task may be related to differences in spatial aptitude (Cooper & Mumaw, 1985). On the other hand, the previous studies have found that not only has the spatial ability of the individual but also the characteristics of the spatial problems lead the use of a strategy (Glück & Fitting, 2003; Burin & Prieto, 2000; Eme & Marquer, 1999; Gorgorio, 1998).

In the light of these studies, this study intends to give detailed information about the strategies used in solving spatial visualization problems. The sub strategies of the main spatial strategies are intended to be defined. Additionally, all the ways of using any strategy for different kinds of spatial visualization problems are tried to be identified. By this way the thought processes of adults while solving different kinds of spatial visualization problems are tried to be stated in detail.

As mentioned before, spatial ability is important for doing mathematics and the development of spatial ability has been accepted as one of the important objectives of geometry and mathematics education programs. It is believed that to develop people's spatial abilities affectively, it is necessary to obtain a better understanding of the difficulties of people in solving spatial visualization problems. Gorgorio (1998) argues that, better knowledge about which difficulties individuals encounter

when solving geometrical tasks could contribute not only to the enlargement of theory but also the solution of the actual problems of teaching mathematics. However, difficulties that individuals experience while solving spatial visualization problems have not been studied in detail and this is a neglected area. One of the few studies on the difficulties in spatial problem solving was held by Baron. He identifies three main limitations; failure to use the appropriate strategy, inadequate proficiency and limited capacity (Baron, 1978). Here, failure to use the appropriate strategy represents the difficulty in selecting the appropriate strategy to solve a spatial problem. Inadequate proficiency means the difficulty in using the selected strategy effectively. And lastly, limited capacity means the limitations in mental capability. In the light of Baron's study, this study also intends to identify and classify the difficulties of people in solving spatial visualization problems in terms of the spatial strategies they use. The limitation in capacity is not a difficulty which can be overcome through education and it could only be overcome by drugs or other influences on the brain (Baron, 1978). Therefore, this type of limitation is neglected in this study.

Based on the literature review above, one of the main purposes of this study is to investigate the spatial strategies of individuals while they are solving spatial visualization problems. In order to achieve this purpose, the strategies of the individuals are intended to be defined and categorized in detail. The general strategies and sub strategies are intended to be defined and different ways of using spatial strategies are tried to be discussed with respect to kinds of spatial visualization problems. The other purpose of the study is to investigate the difficulties of individuals in solving spatial visualization problems. The present study intends to identify how the inadequate proficiency in using the strategies and inappropriate selection of strategies causes difficulties in solving spatial visualization problems. These difficulties are defined as *inadequate proficiency* and *limited flexibility*.

1.1. Research Questions

The following research questions are addressed in this study:

- What spatial strategies do adults use to solve spatial visualization problems?
- What are the difficulties that adults experience while solving spatial visualization problems?

1.2. Definitions of Terms

Spatial Ability: Spatial ability consists of abilities such as changing, rotating, bending and reversing of an object presented for stimulating in the mind. There are two spatial factors; spatial visualization and spatial orientation (Mc Gee, 1979).

Spatial Visualization: Spatial visualization involves the ability to mentally rotate, manipulate, and twist two- and three-dimensional stimulus objects. Spatial visualization entails recognizing, retaining, and recalling movement among the internal parts of a configuration, moving objects in three-dimensional space, or folding and unfolding flat patterns (Mc Gee, 1979).

Strategy: Several alternative methods for performing a particular cognitive task (Saczynsky et al., 2002).

Spatial Strategies: Strategies that people use when solving spatial tasks (Glück & Fitting, 2003).

Spatial Visualization Problems: The problems that require mentally rotate, manipulate, and twist two- and three-dimensional stimulus objects (Olkun, 2003).

1.3. Significance of the Study

Spatial visualization skills are essential in many engineering and technology fields. As Yue (2006) mentioned especially for hand sketching and computer aided design (CAD) of engineering graphics, it is necessary to visualize and represent 3-D objects and assemblies. The previous research studies also reveals that spatial visualization ability is commonly accepted as one of the most important abilities to perform well in mathematics and geometry (Gutierrez, 1985; Herskowitz, 1989; Hodgson, 1989; Presmeg, 1997; Olkun, 2003; Usiskin, 1987). Usiskin (1987) expressed that “there is a consensus among mathematics educators and researchers that visualization, or spatial ability is important because it enhances a global and intuitive view and understanding in many areas of mathematics”. Presmeg (1997) also mentioned visualization was taken to include process of constructing and transforming both visual mental imagery and all of the inscriptions of a spatial nature that might be implicated in doing mathematics. Moreover, According to Battista (1990) underlying most geometric thought is spatial reasoning. With regard to the above studies, this study focuses on spatial visualization ability.

The importance of spatial ability brings out the fact that assessment of spatial ability is an important issue for the researchers studying spatial ability and mathematics educators who are designing tools and activities to develop spatial ability. In order to assess the spatial ability of individuals, the aptitude tests has long been designed and used by the researchers (Ekstrom et al., 1978, French, et al., 1963; Guay, 1977; Vandenberg & Kuse, 1978). However, to make a detailed description of the abilities of individuals, investigating their thought process has also a great importance rather than only using the results of spatial ability tests. Therefore, the main interest of the present study is the process of spatial visualization problem solving. This study intends to give detailed descriptions about the spatial visualization problem solving process.

One of the ways of investigating the thought process of individuals has been accepted to analyze the spatial strategies of people while completing spatial tasks. As Baron (1978) mentioned, strategies were the observable manifestations of intelligence. Research studies have revealed that individuals use different strategies while solving the spatial ability problems and understanding these strategies is important in interpreting individuals' spatial abilities (Glück & Fitting, 2003; Burin & Prieto, 2000; Eme & Marquer, 1999; Gorgorio, 1998). The results of the studies on spatial strategies conclude that the spatial strategies can be categorized as analytic or holistic strategies. The holistic strategies involve maintaining and using information about spatial relations among elements in the mental representation (Glück & Fitting, 2003). On the other hand analytic strategies are the strategies that involve a systematic step by step approach that requires minimal visualization (Hsi et al., 1997). As mentioned above investigation of spatial strategies is accepted to be an efficient way of understanding the spatial visualization of people. Therefore, in the present study, to examine the spatial visualization problem solving process, the spatial strategies are investigated.

As mentioned above, the findings of the studies show that visualization is not the only way of solving spatial problems and people manage to solve spatial problems by using minimal visualization, those are called analytic strategies. However, it is essential to imagine the required manipulation or rotation for areas such as hand sketching or computer aided design in engineering graphics, arts or design. In such cases it is necessary to visualize and represent 2-D or 3-D objects. Therefore, it is important to investigate the used spatial strategies to assess the spatial visualization of people. As, Gitimu and Workman (2007) argued, in order to obtain a clearer understanding of spatial visualization ability, more research needed to detail individuals' use of strategies. This study intends to give detailed descriptions for different strategies used in solving spatial visualization problems. In addition, the previous studies neglect to analyze the spatial strategies while solving orthographic and isometric drawing problems. As Yue (2006) mentioned isometric drawings are

the only pictorial views to show 3-D objects and illustrate their rotations and manipulations. Therefore, it is an important part of spatial visualization ability. This study also intends to give a detailed description of the spatial strategies used in orthographic and isometric drawing problems.

Investigating the spatial strategies to have a deeper understanding of people's spatial ability is firstly attracted the attention of researchers studying on technical drawing used in engineering (Glück & Fitting, 2003; Burin & Prieto, 2000; Eme & Marquer, 1999; Gorgorio, 1998). The review of the related literature on the subject shows that these studies are underestimated by mathematics educators. As a researcher studying mathematics education, to prepare objectives for designing assessment tools or educational programs, it is essential for us to know as many spatial strategies as possible and different ways of using these strategies. This study intends to define the specific strategies and the thought processes used while using these strategies.

Based on the literature review, it can be concluded that most of the studies with the aim of identifying the spatial strategies of people, follow up self-report questionnaires are used to collect data (Burin, Delgado, Prieto, 2000; Eme & Marquer, 1999; Gitimu & Workman, 2007). In other words the participants are given a spatial problem or task to complete and after they finished their work on the problem, they are asked to fill in a questionnaire about the strategies they used while solving the given problem. This way of collecting data is limited to the participants written expressions and their understanding of the given questions in the questionnaire. On the other hand, in the present study, task-based interviews are used to collect data and by this way all the expressions of participants while solving problems, their products and nonverbal behaviors are taken in to account in defining the strategies.

Investigating the difficulties of participants in solving spatial visualization problems is another important issue to have a deeper understanding of people's spatial visualization ability. Gorgorio (1998) claimed that, better knowledge about which difficulties individuals encounter when solving geometrical tasks could contribute detailed information about their spatial ability. Analysis of the difficulties of people in solving spatial visualization ability is expected to give detailed information about the spatial ability of people which is important in assessment. Additionally, while designing programs, courses or activities to develop spatial ability, identification of the difficulties prevents an efficient view on what to emphasize. On the other hand investigating the difficulties of people in solving spatial visualization problems is a neglected subject and there is a few studies analyzing the difficulties.

This study determines to identify and categorize the difficulties of people while solving spatial visualization problems. Baron (1978) identifies three main limitations; failure to use the appropriate strategy, inadequate proficiency and limited capacity (Baron, 1978). In this study difficulties of people in solving spatial visualization problems are identified in terms of the spatial strategies they use and classified in to two; inadequate proficiency and limited flexibility.

1.4. My Motivation for the Study

When I started my profession as a mathematics teacher at a vocational high school in 2002, I had the chance to examine the engineering drawing course. I had already taken the "Teaching of Geometry Concepts" course during my undergraduate education at the university; so I realized that engineering drawing course exercises were similar to spatial activities. This attracted my attention to the importance of spatial ability for mathematics and other branches such as engineering.

In my master thesis (2005), I studied the spatial abilities of high school students. The results of the study revealed that there was a positive relationship between students' logical thinking abilities, mathematics achievement and spatial ability. Additionally, it was found out that engineering drawing activities had a positive effect on the development of students' spatial ability. The data instrument to assess spatial ability was Spatial Ability Test (SAT).

Reviewing the literature about the subject let me realize that spatial aptitude tests are not enough to assess spatial ability of individuals and for a better understanding thought processes should be analyzed. My literature review on the subject showed me that one way of analyzing thought process was analyzing the strategies of individuals while solving problems. However, I noticed that investigation of spatial strategies was a neglected issue in mathematics education. It was mostly studied by the researchers that were studying engineering education. And the studies should be developed. I believe that findings of this study will provide a new frame for spatial ability researches in mathematics education and enlarge the theory on spatial strategies. Moreover, as high school mathematics teacher, I will use the findings of this study in my future profession.

CHAPTER 2

LITERATURE REVIEW

The following chapter gives an overview of the related literature for the research study investigating the spatial strategies adults use and the difficulties they experience while solving spatial visualization problems. Based on the content and the main objectives of the study, the literature is classified in to two sections; a review of spatial ability research and the studies on spatial strategies.

2.1. Spatial Ability

In this part of the study, firstly the literature about the definitions and classifications of spatial ability is reviewed. Different definitions of spatial ability and sub abilities are overviewed. Additionally, the research studies about the importance of spatial abilities for different areas, mathematics and geometry are reviewed. And lastly the research studies about the development of spatial ability and the factors affecting spatial ability are summarized.

2.1.1. What is Spatial Ability?

Since Sir Francis Galton reported on his experimental inquiries in to mental imagery in 1880, researchers have defined spatial ability in numerous ways (Mohler, 2008). However, there is still no consensus about the terminology used for the subject and their meanings.

Thurstone (1938) studied primary mental abilities and defined a “space” factor (Mohler, 2008). He classified *spatial-visual aptitude* as one of the primary mental abilities, generally defined as the ability to mentally manipulate shapes, sizes and distances in the absence of verbal or numerical symbols. Another definition of the *spatial ability* is given by Tartre (1990) as the mental skills concerned with understanding, manipulating, reorganizing or interpreting relationships visually. Battista (1998) used the term *spatial ability* for the ability to formulate mental images and to manipulate these images in the mind.

Visual Spatial Intelligence is defined by Gardner (1985) as the ability to perceive the visual world accurately, to perform transformations and modifications upon ones initial perceptions, and to be able to re-create aspects of one’s visual experience, even in the absence of relevant physical stimuli. Gardner (1985) mentioned that spatial intelligence entails a number of loosely related capacities: the ability to recognize instances of the same element; the ability to transform or to recognize the transformation of one element into another; the capacity to conjure up a graphic likeness of spatial information.

A further definition of visualization, or visual thinking was done by Yakimanskaya (1991) as the kind of reasoning based on the use of mental images. She mentioned that “*spatial thinking*” was a form of mental activity which makes it possible to create spatial images and manipulate them in the course of solving various practical and theoretical problems.

On the other hand the term *spatial sense* was used in the *Curriculum Standards* and it refers to “an intuitive feel for one’s surroundings and objects in them” (NCTM, 1989). Spatial sense in mathematics is considered to involve the use of visualization and spatial reasoning to solve mathematics problems. As an example, Gutierrez (1989) gives the definition of “Visualization” in mathematics as the kind of reasoning activity based on the use of visual or spatial elements, either mental or

physical, performed to solve problems or prove properties. Sjönlinder (2000) accepts with *spatial abilities* as cognitive functions that enable people to deal with spatial relations, visual spatial tasks and orientation of objects in space. And Olkun (2003) defined the spatial ability as the mental manipulation of objects and their parts in two dimensional and three dimensional spaces. In the present study the term *spatial ability* was considered as the ability to manipulate, reorganize or interpret relationships visually.

In the present study, the term “*spatial ability*” is used with the definition given by McGee as the ability consisting of spatial skills as changing, rotating, bending and reversing of an object presented for stimulating in the mind (McGee, 1979).

2.1.2. What is Spatial Visualization?

Spatial ability is not a unitary construct; several different factors have been identified by the psychometric studies (Chu & Kita, 2011). According to Lohman (1979) spatial ability is composed of three factors; *spatial visualization*, *spatial relations* and *spatial orientation*. Spatial visualization is the ability to mentally transform complex stimuli in space. A spatial relation is the ability to rapidly recognize the identity of a simple item under rotation in a speeded task. Spatial ability is the ability to imagine how stimuli will appear from another perspective (Chu & Kita, 2011).

Another classification was defined by Yakimanskaya (1991). She divided the spatial thinking activity in to two; the first one was the creation of mental images and the second one was their manipulation or use, where she defined a mental image as a mental representation of a mathematical concept or property containing information based on pictorial, graphical or diagrammatic elements; a spatial image was created from the sensory cognition of spatial relationships, and it might be expressed in a variety of verbal or graphical forms including diagrams, pictures,

drawings, outlines etc.; spatial thinking was a form of mental activity which made it possible to create spatial images and manipulate them in the course of solving various practical and theoretical problems.

A detailed subscription was given by Kosslyn (1980) and expressed that there were four processes applicable to visualization and mental images;

- Generating a mental image from some given information,
- Inspecting a mental image to observe its position or the presence of parts or elements,
- Transforming a mental image by rotating, translating, scaling or decomposing it,
- Using a mental image to answer questions.

Kimura (1999) defines six spatial factors that can be distinctly identified by experimental measurement;

- *Spatial orientation* is the ability to accurately estimate changes in the orientation of an object.
- *Spatial location imagery* is the ability to recall the position of objects in array.
- *Targeting* refers to the ability to intercept projectiles or throw them at a target.
- *Spatial visualization* is the ability to recognize and quantify the orientation changes in a scene.
- *Disembedding* is the skill that allows a person to find a simple object when it is embedded in a more complex figure.
- *Spatial perception* refers to a person's ability to determine what the prevailing horizontal and vertical directions in a scene where distracting patterns are present (in Velez et al. ,2005).

Tartre (1990) studied McGee(1979) and proposed a classification scheme for spatial ability based on the mental process used in solving a spatial problem. *Spatial orientation* was defined as being able to mentally view one's viewpoint while the object remains fixed in space where *spatial visualization* was defined as mentally moving an object. This mental movement can be in two ways; in *mental rotation* the entire object is transformed by turning in space, on the other hand in *mental transformation* only part of the object is transformed in some way (Sorby, 1999).

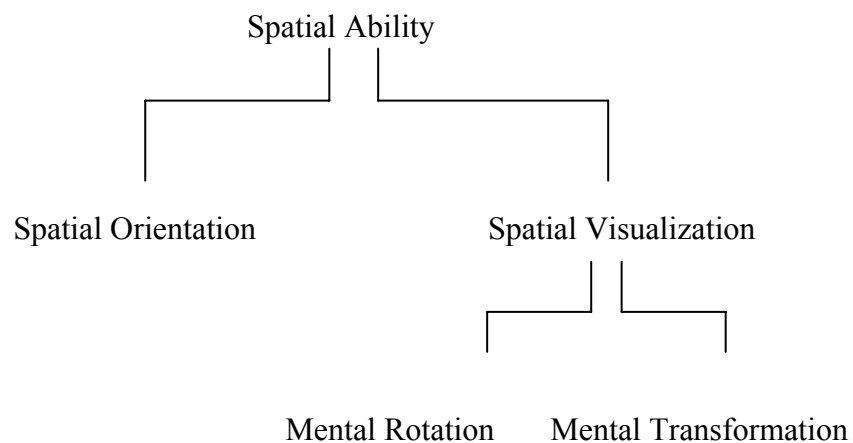

Figure 2.1. The schema of Tartre (1990) taken from Sorby (1999)

According to Osberg (1997), *visualization* takes mental images and adds an affective, almost visceral component, making the image stronger and potentially more meaningful. In other words, the process of visualization has the ability to generate physiological and emotional responses similar to that which we experience during "real-time" perceptions. Additionally, he also described the *spatial relations* as an understanding about the relationship between objects in space, both in dynamic and static environments and he defined rotation as the ability to mentally rotate objects in space, and be able to maintain orientation and attributes during that transition.

On the other hand, Bishop (1983) emphasized the two abilities in visualization; the first one was the *visual processing* of the information, including translation of abstract relationships and non-figural data in to visual terms, the manipulation and extrapolation of visual imagery, and the transformation of one visual image in to another. The second ability was the *interpretation of figural information* involving, knowledge of the visual conventions and spatial vocabulary used in geometric work, graphs, charts and diagrams of all types and the reading and interpreting of visual images, either mental or physical, to get from them any relevant information that could help to solve a problem.

As a result of a meta-analysis of studies made between 1974 and 1982, Linn and Petersen (1985) made a classification of spatial tests into three distinct categories and labeled these categories *spatial perception*, *spatial visualization* and *mental rotation*. Spatial perception was defined as the ability to determine spatial relations despite distracting information and spatial visualization as the ability to manipulate complex spatial information when several stages were needed to produce the correct solution (Linn and Petersen, 1985). Mental rotation was defined by Linn & Petersen (1985) as the ability to rotate, in imagination, quickly and accurately two- or three-dimensional figures.

A slightly different definition of mental rotation was made by Kolb and Whishaw in 1981. They stated that *mental rotation* was the ability to adopt novel perspectives, to see the other side of things. Furthermore, Kolb and Whishaw (1981) divided the mental rotation aspect of the cognitive space into two categories, *visualization* and *orientation*, according to neurological representations. Visualization is the ability to manipulate or rotate two- or three dimensional pictorially presented stimulus objects.

Wiley (1990) has developed a "Hierarchy of Visual Learning" model, which provided a structural framework for how one learns through the process of "visual

cognition, visual production, and visual resolve." These stages were dependent upon one and other, and represented one's ability to mentally comprehend, store, retrieve, create, edit, and communicate spatial information.

Lohman (1979) identified two main aspects of spatial ability; *spatial orientation* and *spatial visualization*. *Spatial orientation* involved the ability to imagine how a given object or set of objects would appear from a spatial perspective different from that in which the objects are shown. According to Tartre (1990) spatial orientation skill appeared to be used in specific and identifiable ways in the solution of mathematics problems. These ways included:

- accurately estimating the approximate magnitude of a figure,
- demonstrating the flexibility to change an unproductive mind set,
- adding marks to show mathematical relationships,
- mentally moving or assessing the size and shape of part of a figure,
- Getting the correct answer without help to a problem in which a visual framework was provided.

Spatial visualization, on the other hand, required:

- complex mental rotation of one or more visualized objects such as those involved in mental paper folding
- Rearrangement of pieces of an object to form the whole object.

According to Ekstrom, French and Harman (1979), *spatial visualization* requires that a figure be mentally restructured into components for manipulation where as the whole figure is manipulated in *spatial orientation*. Orientation requires only mental rotation of the configuration; however, visualization requires both rotation and the performance of serial operations.

In the present study the classification of McGee (1979) was accepted and his definition of the term “*spatial visualization*” was adopted. According to McGee (1979), the available evidence conclusively demonstrates two spatial factors; *spatial visualization* and *spatial orientation*.

Spatial visualization is the ability to mentally manipulate, rotate, twist or invert a pictorially presented stimulus object. The underlying ability involves a process of recognition, retention, and recall of an object manipulated in 3-D space. *Spatial orientation*, on the other hand, involves the comprehension of the arrangement of elements within a visual stimulus pattern and the aptitude to remain unconfused by the changing orientation in which a spatial configuration may be presented (McGee, 1979).

2.1.3. Importance of Spatial Ability

Spatial ability has been an important issue for the researchers from its beginnings in the late 1800s. Different psychometric studies were conducted on the spatial intelligence, its components, relations with other areas and development. Mohler (2008) divided the chronology of spatial ability research in to four major periods of activity. Table 2.1 shows Mohler’s chronology and the associated themes or approach.

Table 2.1. Chronology of Spatial Ability Research with Themes and Approach (Mohler, 2008, pp.19)

<i>Date range</i>	<i>Themes and Approach</i>
1880-1940	Acknowledgement of a spatial factor separate from general intelligence through psychometric studies
1940-1960	Acknowledgement of multiple space factors through psychometric studies; emergence of myriad spatial assessments
1960-1980	Psychometric studies into cognitive issues; emergence of developmental and differential research
1980-	Effect of technology on measurement, examination, and improvement; emergence of information processing research

After the spatial factor had been acknowledged separate from general intelligence, through factor analytic studies, its relations with other areas became an important issue. McGee (1979) concluded that visualization and orientation were more highly correlated with success in a number of technical, vocational and occupational domains than is verbal ability. Similarly, Gutierrez (1985) mentioned that visualization is important for many more activities than we could suspect and the yield of visualization is so wide and diverse that it is not reasonable to try to encompass it all. Yue (2006) expressed the importance of spatial visualization ability and said that it was vital in some hot technologies such as geometric information systems, biomedical information technology and robotics.

Gardner (1985) was also a strong advocate of spatial intelligence and its relationship to other intelligences and cognition. In Gardner's view, spatial ability and spatial cognition were the basic building blocks that a child needed in order to develop higher level thinking skills, specifically those that complement verbal processing skills.

Numerous research studies showed that science achievement at different levels of education was correlated with spatial ability. One of these research studies was held by Pribyl and Bodner (1987) with university students taking organic chemistry course. Their findings showed that high spatial ability students were better at the early stages of problem solving described as "understanding" the problem in organic chemistry. Their model explained students who draw preliminary or extra figures for questions are more likely to get correct answers. Another study held by Carter et.al. (1987) also showed that there was a strong correlation between spatial ability and general chemistry course at different levels.

Pallrand and Seeber (1984) conducted their study with collage-level students to clarify the nature of the relationship between visual-spatial abilities and achievement in science courses. They suggested that taking introductory physics improved visual-spatial abilities and additionally visual-spatial ability influences selection of the science courses. Delialioğlu and Aşkar (1999) also showed that spatial ability was one of the factors influencing secondary school physics achievement.

Geosciences was another branch that researchers found to be correlated with the spatial ability. Recent studies have also shown that in conceptual understanding of geosciences spatial abilities has a great importance. For example the results of Black (2005) suggested that an opportunity may exist to improve Earth science conceptual understanding by focusing on spatial abilities or the spatial aspects of

concepts. Another study held by Orion et. al. (1997) that supported the idea that spatial visualization ability was strongly related to earth-science studies.

In a more general sense, it was claimed by researchers that there was a relationship between logical thinking ability and spatial ability. As an example a study was conducted by Tai (2003). The purpose of the study was to investigate the effects of cognitive style and spatial ability on the logical thinking and problem solving abilities of students with regard to programming language. Study results included the following: students with high spatial ability scored significantly higher than those with low spatial ability in logical thinking ability.

The usefulness of visualization and graphical representations in the teaching of mathematics had been recognized by most mathematics educators and teacher of mathematics (Gutierrez, 1985). Gutierrez also mentioned that the use of visual elements as a part of ordinary teaching of mathematics in different educational levels had started to be underlined. Moreover, McGee (1979) also expressed that numerous research studies had shown that spatial ability was positively related to achievement in mathematics. Usiskin (1987) impressed the importance of spatial ability in mathematics education as “there is a consensus among mathematics educators and researchers that visualization, or spatial ability is important because it enhances a global and intuitive view and understanding in many areas of mathematics. Research studies show that there are relationships between spatial ability and geometrical achievement.” Presmeg (1977) mentioned *visualization* was taken to include process of constructing and transforming both visual mental imagery and all of the inscriptions of a spatial nature that might be implicated in doing mathematics. Additionally, she expressed that mathematics was a subjects that had diagrams, tables, spatial arrangements of signifiers such as symbols, and other inscriptions.

As one could conclude the literature contained a great deal of discussion about the possible relationship between spatial skills and mathematics. In the study of Tartre and Fennema (1985), middle school students were asked to draw pictures to solve mathematics problems. When asked to tell about the problem before solving it, students with high spatial visualization skill and low verbal skill translated the problem into a picture better and had more detailed information on the problems solved correctly.

Another study by Geddes (1993) mentioned that the relationship between geometry and deductive reasoning originated with the ancient Greek philosophers, and remains an important part of the study of geometry. A key ingredient of deductive reasoning was being able to recognize which statements had been justified and which had been assumed without proof. This was an ability which all students should develop in all areas, not just geometry, or even just mathematics.

At first, deductive reasoning was informal, with students inferring new properties or relationships from those already established, without detailed explanations at every step. Later, deduction became more formal as students learn to use all permissible assumptions in a proof and as all statements are systematically justified from what has been assumed or proved before.

Moreover they claimed that studying geometry also provided opportunities for divergent thinking and creative problem solving while developing students' logical thinking abilities. Geometric concepts and representations could help students better understanding number concepts while being particularly well suited for addressing the First Four Standards: problem solving, reasoning, making connections, and communicating mathematics. Students' experiences in learning geometry should help them perceive geometry as having a dynamically important role in their environment and not merely as the learning of vocabulary, memorizing definitions and formulas, and stating properties of shapes. Students, working in

groups or independently, should explore and investigate problems in two and three dimensions, make and test conjectures, construct and use models, drawings, and computer technology, develop spatial sense, use inductive and deductive reasoning, and then communicate their results with confidence and conviction. They should be challenged to find alternative approaches and solutions.

A study was conducted by Hodgson (1996) with the university students to investigate the use of Venn diagrams to visualize set expressions. The results of the study showed that the translation of set expressions provided a rich content for studying students' formation and use of procedures, their understanding and operationalization of set operations, and their ability to establish connections between alternative representations of mathematical concepts.

On the other hand Hershkowitz (1985) discussed the two directions of the role of the visualization in geometry. First one was that, visualization was a necessary tool in geometrical concept formation, because the basic concepts in geometry were visual figures. The second side of the coin is that, unlike judgment based on mathematical definition, visual judgment did not make a clear cut distinction between concept examples and other instances. So, it put some limitations on the individual ability to form all the concepts' examples. In the light of these research studies we can conclude that spatial visualization is an important ability to learn and do mathematics as other sciences. The importance of spatial ability for mathematics and geometry education made the mathematics educators and the researchers study on the development of spatial ability.

2.1.4. Development of Spatial Ability

The importance of spatial ability yielded in to studies in the development of spatial ability. So, the researchers' most of the efforts of study focused on developing and

refining instructional materials, performing experimental teaching, and analyzing the experimental data.

Piaget and Inhelder (1971) developed a theory on the development of one's spatial ability with age. According to their theory spatial ability develop in three stages. In the first stage, *topological* skills acquired at the age of 3 to 5. Children acquire 2-D skills and learn the relationships of objects to one another. The second stage is the *projective space* stage and this ability requires visualizing 3-D objects and perceiving what they will look like from different viewpoints or if they were rotated or transformed in space. In the third stage individuals learn to go back and forth between 2-D and 3-D. At this stage a person is able to combine measurement concepts with their projective skills (Mohler, 2008; Sorby, 1999).

Research in this area has found that age effects spatial ability and age-related differences are often a result of differences in processing speed, knowledge and experience, and age effecting accuracy in problem solving (Mohler, 2008). Various research studies insisted that, there was a positive relationship between spatial training and the students' spatial skill enhancement (Olkun, 2003; Owens & Clements, 1998; Osberg, 1997; Herskowitz, Parzysz & Van Dormolen, 1996; Pallascio & Allaire & Mongeau, 1993). As an example, Olkun (2003) mentioned that, although there were somewhat conflicting results in the literature regarding whether spatial ability could be improved, numerous studies have indicated that it could be improved through training if appropriate materials are provided. Therefore the researchers focused on the types of exercises that will help the students to develop their spatial abilities.

Sorby (1999) expressed that several research studies had been conducted to determine what type of pre-collage activities tended to be present in those students who had well developed spatial ability. And they concluded that, activities that

required eye-to-hand coordination were those that helped to develop spatial ability. And such activities included;

- Playing with construction toys as a young child
- Practicing in classes such as shop, drafting or mechanics as a middle school or secondary student
- Playing 3-D computer games
- Participating in some kinds of sports
- Having well-developed mathematical skills.

Furthermore, Bennie and Smith (1999) insisted that spatial sense could not be taught, but had to be developed over a period of time. Moreover they stated that a number of researchers referred to the importance of learners engaging with concrete spatial activities before being able to form and to manipulate visual images.

Another study was carried out by Herskowitz (et al., 1996). In the study the effect of the Agam Program was investigated. The main goal of the Agam Program was to develop young children's abilities to perceive, think and create by using visual language. The Agam Program was a set of activities that helped the development of a visual language with a process of developing visual thinking. The program consisted of 36 units that introduce children to basic visual concepts and certain visual skills. The results of the study showed that Agam Program increased the general intelligence of the trained students in comparison with non trained ones. Strong effect was also found on general school readiness, expressed in writing, geometry and logical thinking. Agam children demonstrated a significantly greater ability to identify visual concepts in complex contexts, a better understanding of these concepts and a better application of them in complex visual settings expresses that studies show that improvements in imaging were associated with the acquisition of concrete operations and that success on the judgment version of a

task is a prerequisite for success on the corresponding imaging version had been interpreted as support for Piaget's position (Dean, 1976).

The study of Owens and Clements (1998) supported this claim. The main problem of the study was, "How primary school students solve two dimensional spatio-mathematical problems, and how their environment in problem solving activities could assist them to develop and use visual imagery and spatial concepts." Moreover in the study the roles of responsiveness, visual imagery, and selective attention were described. They concluded that the making of shapes, the comparing of angles and the "finding" of shapes in the designs-with-matches task seemed to improve the students visualizing. The activities encouraged the students to dissembled shapes and parts from more complex shapes to imagine where other shapes such as angles and sides, and to consider what might be the result of systematic changes to shapes or configurations.

Another study that focuses on the improvement of spatial visualization was constructed by Battista (1989). In the study, pre- and post-test a group of elementary education majors enrolled in an informal geometry course which primarily used hand-on activities and manipulative aids. Results of this study yielded significantly higher spatial visualization scores on the post-test and on the pre-test. Thus the researchers concluded that the types of activities used in the course might have a direct influence on the improvement of spatial visualization ability.

Also, Beanninger and Newcombe (1989) found reliable relationship between spatial activity participation and spatial visualization ability (Robichaux, 2003). Other than studies on developing spatial ability activities Robichaux (2002) designed a research and primary objective of the research was to provide a theoretical explanation of the development of spatial visualization abilities. He concluded that, spatial visualization developed over a period of time as a result of

one's experiences and certain exogenous qualities. Moreover, he mentioned that, spatial visualization was influenced by one's childhood experiences, which were found to be influenced by one's gender, parents' occupations and family income. After this first study, another study of Robichaux (2003) was designed to gain a better understanding of the thinking processes that occur as one engages in spatial visualization activities and to improve the spatial visualization ability of the participant through the use of such activities. He concluded that, spatial visualization ability could be developed when real concrete objects were used over a period of time so that subsequently the user couldn't mentally utilize the concrete objects when presented tasks that were strictly in two dimensions. Additionally, he discussed that, mathematics teacher educators should engage their pre-service teacher students in hands-on activities similar to those used in this study and insisted that they, too, verbalize their thoughts. The results of this study suggested that engaging one in spatial tasks once a week every other week over the course of one semester while verbalizing one's thought processes did improve one's spatial visualization.

Pallascio (et. al., 1993) expressed the objective of the experiments that they highlighted was to study the development of spatial competencies through the use of activities focusing alternatively on analytic and synthetic competencies. At the end of the study they concluded that the development of spatial competencies in geometry by means of alternating analytic and synthetic activities had produced a number of results that could enrich the teaching of geometry. In the creation or generation of spatial representations, hands-on work with physical media was certainly important but it was also important not to create new obstacles to learning, where Battista and Clements (1998) suggested that structuring two dimensional and three dimensional spaces was the foundation for geometric and visual thinking. Where, spatial structuring an object determines its nature or shape by identifying its spatial components, combining components into spatial composites, and establishing interrelationships between and among components

and composites. Moreover they insisted that all of geometry is, in essence, a way of structuring space and studying consequences of that structuring.

Another study by Osberg (1997) evaluated the effect of designing and experiencing a virtual world as a spatial processing skill enhancement method, and as an aid to cognitive development. As a result the data support the hypothesis that intensive training in three-dimensional thinking could help a child gain skills necessary for spatial cognition. Therefore, intensive training in three-dimensional thinking could help a child gain skills necessary for spatial cognition, where spatial cognition was the process by which a child perceived, stored, recalled, created, edited, and communicated about spatial images.

On the other hand a study by Zimler and Keenan (1983) showed that spatial ability can be developed even without seeing. In their studies, they compared congenitally blind vs. sighted individuals who were asked to perform three different tests, all of which involved visualization of objects. In all cases, the blind individuals did better than sighted individuals recalling concepts that were auditory in nature. However, when comparing visual and auditory concept recall, blind subjects remembered more visual concepts than concepts in any other category. This led the researchers to believe that blind people do in fact visualize, at least in a fashion that works for them. The conclusions were that visualization was highly individualized, and that meaning could be developed regardless of the sense modality used to encode the information to begin with. Furthermore, visualization was a naturally occurring event, even in individuals blind from birth.

The researchers that deal with the cognitive developments of the students mentioned that not only the spatial trainings but also the age and the maturation were important on the development of students' spatial skills. As an example, van Hiele, two Dutch educators studied children's development of geometric thought. At the end of their study they concluded that children pass through five levels of

reasoning in geometry; visualization, abstraction, deduction and rigor. These levels were in much the same way that Piaget said children must precede through the stages in cognitive development. They proposed that progress through these five levels, is more dependent on instruction than on age or maturation. And moreover, research studies had shown that materials and teaching can be matched to the levels and promote growth.

Similarly, Patterson and Milakofsky (1980) stated that, the stage theory of childhood development as described by Piaget (1952) had a great deal of relevance when one discusses mental maturity for certain types of reasoning, specifically higher level thinking skills. Regardless of the order or the age at which these skills appear, Piaget was able to identify important components to spatial processing, such as the ability to comprehend perspective, transformations, ordinal relations, classification, kinetic imagery, reciprocity, transitivity, probability, and conservation.

Another study by Alias, Black and Gray (2002) mentioned that four stages of cognitive development have been suggested, that is, (i) the sensory-motor stage, (ii) the pre-operational stage, (iii) the concrete operational stage, and (iv) the formal operational stage. A person who was at the concrete operational stage "...always started with experience and made limited interpolations and extrapolations from the data available to his senses" (Piaget in Phillips, 1969, p. 104). On the other hand, a person at the formal operational stage did not need to experience in order to generate and evaluate propositions. As such, a formal operational thinker could be expected to make use of a variety of spatial possibilities and to have better spatial skills compared to those who have yet to reach this stage. According to Piaget and Inhelder (1971), children started to develop their formal operational skills at the age of 13 and reaching their maximum potential by the age of 17, suggesting that students in post secondary education are formal operational thinkers. However, later studies had shown a high percentage of post-secondary students who had yet

to reach the formal operational stage (Killian, 1979; Reesink, 1985). This had significant implications for teaching even in higher education, since reaching the formal operational stage was a result of a combination of maturation and experience. While maturation might come with age, experience was most likely to be the consequence of education.

Another similar study was in 1986 with college women. The results showed that the collage women that receive training in physics and the Euclidean reference system led to improvement on the water level task. Where the water level (horizontality) test is a 15-item test required participants to draw a horizontal line representing the water level on a drawing of a tilted drinking glass. Participants were first shown an outline drawing of a drinking glass being held by a person and were informed that the glass was half full of water as indicated by the horizontal line. They were told that on the following pages the glass would be shown in various orientations, and that they should draw the line where it should appear, using the pencil and ruler provided (Li, 2000).

As one could conclude from the previous research studies, spatial ability is important for mathematics achievement and it can be developed by appropriate training. Therefore, mathematics teachers are expected to have high spatial abilities and know how to develop their students' spatial ability. In the standards of NCTM (2003) for the candidates of middle school mathematics teachers it was expressed that the teacher candidates were expected to

- use spatial visualization and geometric modeling to explore and analyze geometric shapes, structures and their properties,
- build and manipulate representations of two- and three-dimensional objects and perceive an object from different perspectives,
- apply transformation and use congruence, similarity and line or rotational symmetry.

The importance of spatial ability and its development made Turkish researchers study on the subject in recent years. Çakmak (2009) studied on the effect of origami-based instruction on the students' spatial ability. She found a positive effect of origami-based instruction on the elementary students' spatial visualization and spatial orientation abilities.

The use of technology in the development of spatial ability was also a recent subject studied by the researchers. Boyraz (2008) investigated the effects of two different methods of dynamic geometry based on computer instruction. The results showed that computers created a dynamic learning environment which supported development of students' spatial ability.

2.2. Spatial Strategies

In this section of the study, the related literature is reviewed about the spatial strategies. This section has two parts. First of all the definitions and classifications of spatial strategies that have already identified are given. And in the second part the studies on spatial strategies are considered.

2.2.1. Classifications and Definitions of Spatial Strategies

The researchers who conducted research studies to identify different spatial strategies of people in solving spatial problems or tasks made different classifications and identifications about the spatial strategies. One of the classifications was given by Gluck and Fitting (2003). They reviewed strategy-related evidence from three domains of spatial cognition, namely, mental rotations, spatial tests, and spatial orientation or navigation. As a result they concluded that reliable individual differences existed in the strategies that people used when solving spatial tasks. They classified the spatial strategies of people in solving the mental rotation tasks as *holistic* and *analytic*. *Holistic strategies* involve

representing and manipulating spatial information “in a spatial way,” that is, maintaining and using information about spatial relations among elements in the mental representation. Holistic strategies frequently involve visualization, but they also include other ways of representing spatial relations, such as maintaining a sense of the direction of a reference point while navigating an environment. On the other hand, *Analytic strategies* represent and manipulate spatial information by reducing it to an essentially non-spatial, list-like format. For example, a route can be represented as a list of landmarks, and the spatial relations among the patterns on a cube can be represented as a list of relations among pairs of patterns (Just & Carpenter, 1985). Thus, the complexity of spatial information is reduced; the focus is on parts of the object or the environment rather than on the object as a whole (which would include the spatial relations among the parts). They also expressed that, analytic and holistic strategies should not be viewed as mutually exclusive categories; rather, they are the poles of a continuum. There are intermediate strategies, such as mental rotation of parts of an object, and people often use more than one strategy to solve a task, for example, to double-check a solution (Just & Carpenter, 1985).

On the other hand, Schulz (1991) defined three basic strategies in mental rotation tasks. One was *Move Oneself* that requires imaginary change of one’s own viewpoint. The other one was *Move Object* which requires imaginary manipulation of the stimulus object. And the last one was *Key Feature* which requires the analysis and manipulation of important features of the stimulus object.

According to Burin and Prieto (2000) there were two general kinds of solution strategies for spatial visualization tasks. One is an *analytic* or *feature comparison* approach, in which the examinee seeks to verify the identity of key features of the probes to match them with the target stimulus. A variant of this analytic strategy is verbal labeling of the features. The other is a *holistic* or *spatial manipulation*

strategy, which involves mental movements of the probes, such as rotation, translation, synthesis, etc.

Hsi, Linn and Bell (1997) mentioned that several specific spatial reasoning strategies had been studied for mental rotations: holistic, analytic, and pattern-based. They explained that, solvers using the *holistic strategy* rely on visualizing the entire object. For instance in the cube-counting task, students using a holistic approach visualize the object as a whole, and rotate the object mentally to “see” how many cubes are touching. On the other hand, an *analytic strategy* involves a systematic, step by step approach that requires minimal visual rotation. For example, a student using an analytic strategy for cube counting would count the cubes systematically from left to right, and top to bottom. Another strategy is *template* or *patterned-based strategy* that involved abstracting the problem into familiar elements such as single columns or planes of blocks and reducing the solution to cases previously solved (Hsi et al., 1997).

Eme and Marquer (1999) made a more detailed classification for mental rotation tasks. In *mental rotation strategy*, first, the subject encoded one or more elements of the standard figure, looked at the direction of the arrow, and performed a mental rotation of the encoded configuration. He/she visualized a complete continuous or discontinuous movement, as well as its product. The second step in the processing consisted of comparing the mental image resulting from the rotation to the visual image of the test figure, and potentially using the verbal representation for verification. In some cases, a second rotation in the opposite direction was applied to the test figure in order to compare it to the initial figure. For, *partial rotation strategy* the subject encoded one or more elements in the standard figure and used a "symmetry rule" or a "crossing over rule" (relative to the middle of the figure), which is easier to apply than mental rotation. This rule consists of imagining that whatever is on the top left will end up on the bottom right, and whatever is on the top right will end up on the bottom left, etc. (without necessarily visualizing the

transformation itself)'. The subject memorized the mental product of the transformation in imaged and/or verbal format, which he/she then compared to the visual image. *Verbal strategy* included encoding the relative locations of at least two elements in the standard figure in the form of a verbal sequence in clockwise or counterclockwise order. The rotation information given in advance was ignored. As a second step, the subject searched the test figure for the first element in the verbal sequence stored in memory, encoded the test figure via a comparable verbal sequence, and then compared the two verbal sequences. And lastly *projection strategy (mixed strategy)* consisted of imagining the change in angle of the standard figure without rotating it mentally. The subject processed the relative locations of the elements with respect to each other, which remained constant, and the changes in those locations with respect to the frame of reference (the screen, or the circle around the figure).

The review of previous studies showed that, there are two general classifications for spatial strategies; *holistic* and *analytic* strategies. Holistic strategy requires visualizing the entire object where analytic strategy involves minimal visualization but rather systematic step by step approach. However, there are strategies that could be defined as between these two end of poles such as *partial rotation*, *projection* or *pattern based strategies*.

2.2.2. Studies on Spatial Strategies

The cognitive study of abilities has tried to identify mental structures, processes, representations and strategies that underlie test performance (Pellegrino, 1988). A *strategy* was one of several alternative methods for performing a particular cognitive task (Saczynski, Willis, & Schaie, 2002 in Gitimu & Workman, 2007). As Gitimu and Workman (2007) mentioned, strategy is the way an individual organizes the many sensory-motor systems for meaning. In solution of a problem

the decision of the strategy may depend on many internal and external factors and it is not consciously determined.

Thurstone (1938) argued that when different people use different abilities to solve a test, the test comes to load on more than one factor. Thus psychometricians tend to perceive strategy variability as a problem because it affects the interpretability of test scores. Therefore, as the other abilities, to understand the spatial aptitudes of people, the spatial strategies they selected while solving spatial problems or tasks will give reasonable clues. Additionally, knowing people's strategies played a crucial role in understanding the differences in their spatial aptitudes (Glück & Fitting, 2003). Glück and Fitting (2003) affirmed that individuals differed in the way they solved spatial tasks of all kinds, and both research on and measurement of spatial ability could profit from an integration of strategy aspects. Similarly, Lohman and Kyllonen (1983) concluded that, studies which had examined the relationship between strategy and ability suggested that a subject's ability profile plays a role in solution strategy choice and efficiency.

Additionally, strategy differences were a result of task characteristics and characteristics of the individual. Use of analytic strategies is positively related to stimulus complexity. Psychometric literature shows strategy variability in all tasks and a positive relation between item difficulty and use of analytic strategies. Strategy use is in part task dependent. Strategy flexibility may be an important cue to good performance. Spatial tasks differ in strategies that are best suited for solving them fast and accurately. Thus the best performers may be those who have a large repertoire of strategies and are able to select the best strategy based on the characteristics of each task (Glück & Fitting, 2003).

In their review of strategy literature Lohman and Kyllonen (1983) concluded that solution strategy is a function of both the person and the item. Different people use different strategies and people shift strategies within tests. Most people can solve

easy tasks by holistic strategies, whereas with more complex spatial information or more complex stimulus manipulations, strategies become more analytic. Although analytic representations of spatial information take less effort to encode and maintain, processing capacity limitations are not the only reason why some people use analytic instead of holistic strategies (Glück & Fitting, 2003). Practice does not necessarily lead to less frequent use of analytic strategies; it may even lead to more frequent use of these strategies. Probably, the effect of experience depends on the types of activities an individual engages in (Glück & Fitting, 2003). Visualization tasks are more complex than spatial relation ones and admit various solution strategies (Lohman & Kyllonen, 1983).

According to Burin and Prieto (2000), subjects high on ability could be employing real spatial processes, while others try to solve the problems in a more analytical way. *Analytic* or key feature comparison approach, is the one in which the examinee seeks to verify the identity to key features of the probes to match them with the target stimulus. The other is a *holistic* or spatial manipulations strategy, which involves mental movements of the probes, such as rotation, translation, synthesis, etc. The patterns of results suggest that choice of strategy is not related to visualization ability level. Visualization tasks are often solved by non-spatial approach (Burin & Prieto, 2000).

Gorgorio (1998), on the other hand, contrary to many researchers who refer to visual and analytical individual distinction, the researcher introduces a new parameter, the nature of task. In his article, he presented the analysis of the functionality and effectiveness of the different kind of strategies as a function of the task's characteristics.

He mentioned that there was growing evidence that students' spatial abilities could be developed by different teaching methods. Therefore, better knowledge about what kinds of strategies students use, and which difficulties they encounter when

solving geometrical tasks could contribute not only enlargement of theory but also the solution of the actual problems of teaching mathematics.

Lean and Clements (1981) listed topics where students with poorly developed spatial ability might experience difficulties, and these include geometric transformations such as translations, reflections, rotations, dilations and expansions.

Baron (1978) identified three limitations on ability to do a task:

- failure to use the appropriate strategy
- inadequate proficiency
- limited capacity.

According to Baron (1978), failure to use the appropriate strategy could be overcome through training and proficiency limitations could be overcome by practice on the task which the strategy in question is used.

Baron's concern for strategies was based on the following assumptions;

- strategies can be modified by educational manipulations,
- strategies seem to be observable manifestations of intelligence,
- capacities influence manifestations of intelligence in part through their influence on the acquisition and use of strategies.

Hence, Baron concluded that if one knows what strategies used, one would be in a better position to discover which capacities were most important.

Gitimu and Workman (2007) argued that variation in use of strategies was related to task complexity or difficulty. According to them even within a single type of test, item difficulty could affect which strategies are chosen. Thus, item and test difficulty might be major determinants of strategy use in a task that measures spatial ability. Gages (1994) also mentioned that problem difficulty was the strongest factor that influenced choice of strategy used, whereas spatial ability was a factor for intuitive choice of strategy (Gitimu & Workman, 2007). Additionally, they concluded that individuals used multiple strategies to accomplish most cognitive tasks. Different strategies were selected by the same participant for different problems and for the problems solved on different occasions (Gitimu & Workman, 2007).

Kyllonen et al. (1984) studied the strategies of subjects solving paper-folding task and they concluded that subjects differed in the strategies they normally used and often shifted strategies between and also within different spatial tests. As items within a test became more difficult, the tendency to use analytic, non-spatial strategies appeared to increase. According to them, shifting and adapting their strategies on a mental paper-folding task repeatedly, with strategies ranging from simple inspection of unfolded paper on the easiest items to verbal labeling and sub vocal speech on the most difficult items. They found out that in paper folding test, on easy items, subjects said that it was not necessary to imagine the folding and unfolding of the paper. Instead, solutions could be reached through simple analysis of the punched figure. As items became more difficult, most subjects reported that it became necessary to construct a mental image of the folding and unfolding of the paper to keep track of the punched holes. With the most difficult items, subjects also reported using sub vocal speech to keep track of number of layers in the folded paper, the direction and the orientation of previous folds, the location of obscured layers of paper, and the overall symmetry of the figure.

Thus surprisingly, simultaneous presentation seemed to encourage the use of a mental visualization strategy; successive presentation seemed to promote a more analytic strategy for some subjects. Moreover, they claimed participants reduced their visualization workload by using symmetry, by recognizing and discriminating certain kinds of folds, by keeping a mental record of folds and then only unfolding the necessary ones, and by associating certain fold types with certain punched hole patterns. They also showed that strategy training and performance feedback treatments were successful in improving performance on a spatial visualization task for which training was specifically designed and also on a transfer task. Additionally, strategic training for spatial aptitude task performance appears beneficial to some degree.

Snow (1980), also investigated strategies for the paper folding test using a retrospective questionnaire, along with eye fixation records collected during item performance. Individuals appeared to differ in the strategy they follow. The most effective strategy appeared to combine mental image construction from stimulus analysis with self-terminating match of the result to response alternatives.

On the other hand Carpenter and Just (1979) identified two strategies for performing a cube comparison task, using errors, latencies, eye movement tracks, and self-reports. One strategy involved holistic representation and processing, and other was a sequential, feature-by-feature, transformation strategy. The latter strategy was associated with poor performance.

Cochran and Wheatley (1989) investigated the individual differences in cognitive strategies and their relationship to spatial ability, sex and handedness by using a self report spatial strategy questionnaire. They claimed most studies had investigated only the frequency of strategy but not the difficulty and it might be the difficulty of holistic strategies rather than the frequency of their use that was related to spatial ability test performance. According to them, in attempting to

improve the performance of individuals having low spatial ability, one might begin with less difficult tasks to allow skill in the use of holistic strategies to develop and then require more difficult tasks to be performed, carefully monitoring the generalization and flexibility of strategy use.

Individuals with different spatial visualization abilities use different strategies to understand, analyze, interpret, and solve spatial problems. To obtain a clearer understanding of spatial visualization ability, research needs to detail individuals' use of strategies. (Gitimu & Workman, 2007).

In summary, previous work suggests that at least two effective strategies are employed on spatial visualization tasks; one is systematic mental-construction strategy involving holistic representation and comparison process; the other is an analytic strategy in which features of the stimulus figures are encoded, transformed and compared sequentially.

Subjects with different ability profiles appear to use different strategies and to be differentially affected by treatments that attempt to train these different strategies. Thus performance on spatial visualization tasks may be improved through direct training, but the evidence is mixed.

2.3. Summary

Spatial ability has been accepted as one of the primary abilities for people for their academic achievement and their daily lives. Therefore, numerous studies have been conducted about the subject from its first coming out in 1880s (Battista, 1998; Gardner, 1985; Lohman, 1979; McGee, 1979; Sorby, 1999; Tartre, 1990; Thurstone, 1938; Yakimanskaya, 1991). Different terms, definitions and classifications have been used by the researchers and psychometricians about the subject.

In the present study, the term “*spatial ability*” was used with the definition given by McGee as the ability consisting of spatial skills as changing, rotating, bending and reversing of an object presented for stimulating in the mind (McGee, 1976). Additionally, the classification of McGee (1979) was accepted. According to McGee (1979), the available evidence conclusively demonstrates two spatial factors; *spatial visualization* and *spatial orientation*. *Spatial visualization* is the ability to mentally manipulate, rotate, twist or invert a pictorially presented stimulus object. The underlying ability involves a process of recognition, retention, and recall of an object manipulated in 3-D space. *Spatial orientation*, on the other hand, involves the comprehension of the arrangement of elements within a visual stimulus pattern and the aptitude to remain unconfused by the changing orientation in which a spatial configuration may be presented (McGee, 1979).

After spatial ability had been accepted as a separate factor of intelligence, its relations with other areas became important for the researchers. Numerous studies showed that mathematics and science achievement were strongly linked to spatial ability. In different levels of education, the studies showed that high spatial ability was important in science achievement (Black, 2005; Carter et al., 1987; Delialioğlu, 1996; Delialioğlu & Aşkar, 1999; Elmore and Vasu, 1987; Orion et al., 1997; Pallrand & Seeber, 1984 Tracy, 1990; Pribyl & Bodner, 1987).

The relationship between mathematics achievement and spatial ability had been one of the most studied subjects by the researchers and Usiskin (1987) mentioned that there is a consensus among mathematics educators and researchers that visualization, or spatial ability is important because it enhances a global and intuitive view and understanding in many areas of mathematics. The research studies showed that there was a strong relationship between mathematics and geometry achievement and spatial ability (Herzkowitz, 1989; Hodgson, 1996; McGee, 1979; Presmeg, 1977; Tartre & Fennema, 1985; Usiskin, 1987). Therefore, development of spatial ability became a primary subject for mathematics educators

and researchers. The long term research studies showed that spatial ability could be developed by spatial training and the students' spatial skill enhancement (Olkun, 2003; Owens & Clements, 1998; Osberg, 1997; Herskowitz, Parzysz & Van Dormolen, 1996; Pallascio & Allaire & Mongeau, 1993).

In the measurement of spatial ability, the researchers used tests developed by psychometricians or themselves. However, as Thurstone (1938) mentioned when different people use different abilities to solve a test, the test comes to load on more than one factor. So, as the other abilities, to understand the spatial aptitudes of people, the spatial strategies they selected while solving spatial problems or tasks will give reasonable clues. This finding made researchers study on the spatial strategies of people use in solving spatial problems and spatial tasks and according to the research findings different classifications of strategies were defined (Burin & Prieto, 2000; Eme & Marquer, 1999; His et al., 1997; Glück & Fitting, 2003; Just & Carpenter, 1985; Lohman & Kylönnen, 1983).

In the light of all the classifications given in the previous studies, in the present study spatial strategies of the participants while solving spatial tasks were classified as *holistic* and *analytic strategies* (Burin & Prieto, 2000; Eme & Marquer, 1999; His et al., 1997; Glück & Fitting, 2003; Just & Carpenter, 1985; Lohman & Kylönnen, 1983). Holistic strategy requires visualizing the entire object and maintaining and using information about spatial relations among elements in the mental representation. On the other hand, *analytic strategy* involves a systematic, step by step approach that requires minimal visualization. However, analytic and holistic strategies are not mutually exclusive categories; they are poles of a continuum. There are intermediate strategies such as *pattern based strategy*, *partial rotation strategy* and *projection strategy*.

The findings of the research studies showed that strategy differences were a result of task characteristics and characteristics of the individual. According to Burin and

Prieto (2000), subjects high on ability could be employing real spatial processes, while others try to solve the problems in a more analytical way. On the other hand, use of analytic strategies is positively related to stimulus complexity (Glück & Fitting, 2003). Moreover, different people use different strategies and people shift strategies within tests. Most people can solve easy tasks by holistic strategies, whereas with more complex spatial information or more complex stimulus manipulations, strategies become more analytic (Lohman & Kylonnen, 1983).

In summary, previous studies showed that subjects with different ability profiles appear to use different strategies and to be differentially affected by treatments that attempt to train these different strategies. Thus performance on spatial visualization tasks may be improved through direct training, but the evidence is mixed.

CHAPTER 3

METHODOLOGY

The purpose of the present study is to investigate the spatial strategies and the difficulties of adults while they are solving spatial visualization problems. In this chapter the related issues concerning the context of the research study, the participants of the study, and procedures of data collecting, the data analysis and the assumptions and limitations of the study are described.

3.1. Research Design

In order to examine the spatial strategies of participants that they use to solve spatial visualization problems and their difficulties in solving spatial visualization problems, qualitative research methodology is used to support methodological perspective and findings of the research. Merriam (1998) states that qualitative studies focus on the process and rich in description and the main interest of this research study is spatial problem solving process of participants.

Additionally, Merriam expresses that qualitative researchers are interested in understanding how people make sense of their world and the experiences they have in the world. Therefore the qualitative research methodology is selected for the present study.

This study intends to gain a deep understanding of the spatial problem solving process of mathematics teacher candidates and meaning for those involved (Stake, 2000). Yin (1994) states that case study is an empirical inquiry that investigates a contemporary phenomenon within its real life context. Therefore, the descriptive and exploratory nature of qualitative case study research is particularly appropriate for the present research.

This study aims to look for patterns in the data and come up with a model within which to view this data therefore according to categorization of Yin (1993), the present study is an exploratory case study. The case of this study is the group of five students from elementary and secondary mathematics education departments at a university in Ankara, in Spring Semester of 2007-2008 academic years who voluntarily participate in this study. The participants of the study are explained in detail in Part 3.2.

3.2. Participants of the Study

In this section, the participants who are the ‘case’ of the study are described in detail. Participants of the study are five adults those are studying secondary or elementary mathematics education at a university in Ankara in the spring semester of 2007-2008 academic years who voluntarily participate the present study.

The participants are not at the same grade level, there are masters, doctorate and senior level participants and they are called as adults in the present study.

As Merriam (1998) stated, since the statistical generalization is not the aim of a qualitative research, non-probabilistic sampling is the method of choosing the participants. The researcher wants to discover, understand and gain an in depth understandings about the spatial strategies of the participants. Therefore, a case from which the most can be learned is selected (Merriam, 1998).

In selecting the participants of the present study, the main concern is to find out as many strategies as possible. Additionally, the participants are expected to answer the problems in any way and explain their solutions and the difficulties clearly. In this content, the participants are selected among adults. Adults are expected to have different spatial strategies and they are expected to express their strategies more clearly.

Previous research results indicate that mathematics and spatial ability has a strong relationship (Herskowitz, 1989; Hodgson, 1996; Presmeg, 1997; Usiskin, 1987). Therefore, as students studying mathematics education, the participants are expected to be aware of “spatial ability” factor; and expected to have a reasonable spatial ability level. This would help them know what are expected from them when they come across the data collecting tools. This helps the researcher collect efficient data, so this group is selected as a case of adults.

In the study, collecting data continued during a semester and each task-based interview session took nearly an hour. Therefore; the data collecting process was time consuming for the participants. Additionally, participants answering the data collecting instruments sincerely and truly was important to gather the desired data. So, in the selection of the participants, their being volunteer is the main criteria. At the beginning of the spring semester of 2007-2008 academic years, the students that took elective graduate courses offered by the elementary and secondary mathematics education courses were given information about the study and asked whether they wanted to be in the study voluntarily. Five of them accepted to be a part of the study and became the participants of this research.

In the present study, to protect the personal rights of the participants the codes are used to define participants rather than using their names. They are coded as participants from 1 to 5 (P₁, P₅). The characteristics of the participants are defined as follows;

Participant 1 (P_1) is studying her PhD degree in the department of Secondary Science and Mathematics Education (SSME) and has her BS degree of Mathematics Department. The average of her grades of the mathematics courses she has already taken at the university was 2.5 over 4. The Spatial Ability Test (SAT) scores of P_1 shows that she has problems in completing the test at required time; moreover she has lots of incorrect answers in manipulation problems.

Participant 2 (P_2) is studying her PhD degree in the department of Secondary Science and Mathematics Education (SSME) and has her BS degree of Mathematics Department. The average of her grades of the mathematics courses she has already taken at the university was 3 over 4. The Spatial Ability Test (SAT) scores of P_2 shows that she has the highest score and she mostly completes all the tests with low number of incorrect responses.

Participant 3 (P_3) is studying her MS degree in the department of Secondary Science and Mathematics Education (SSME) and has her BS degree from the department of Elementary Mathematics Education. The average of her grades of the mathematics courses she has already taken at the university is 3.2 over 4. The Spatial Ability Test (SAT) scores of P_3 show that she has the second highest score. The number of her incorrect responses is low but she had difficulties in completing the tests in the given time.

Participant 4 (P_4) is a senior student of Elementary Mathematics Education (EME) Department and the average grade for the mathematics courses (AGM) she has already taken at the university is 2.15 over 4. The Spatial Ability Test (SAT) scores of P_4 shows that she couldn't manage to complete the tests, and she has quite high number of incorrect responses.

Participant 5 (P_5) is also a senior student of Elementary Mathematics Education (EME) Department and her average grades of mathematics courses that she has

already taken is 2.6 over 4. The Spatial Ability Test (SAT) scores of P₅ show that she has also low scores. The number of unanswered and incorrect responses is nearly the half of the test.

Table 3.1. The Participant Characteristics

<i>Participants</i>	<i>Department</i>			<i>AGM (Over 4)</i>	<i>SAT Score (Over 282)</i>
	<i>BS</i>	<i>MS</i>	<i>PhD</i>		
P ₁	Math		SSME	2.5	87
P ₂	Math		SSME	3	207
P ₃	EME	SSME		3.2	178
P ₄	EME (senior)			2.15	158
P ₅	EME (senior)			2.6	122

Table 3.1 summarizes the participants' characteristics. The given characteristics are the departments that the participants studied in undergraduate and graduate levels, their SAT scores and the average grades for the mathematics courses they have already taken.

3.3. Data Sources

This study investigated i) the spatial visualization problem solving strategies of the individuals, and ii) the difficulties they experienced during solving spatial visualization problems.

To collect data; 1) Spatial Ability Test (SAT); 2) Structured Task-Based Interviews were used.

3.3.1. Spatial Ability Test (SAT)

At the beginning of the study the Spatial Ability Test (SAT) was administered to the participants. SAT is paper-pencil test that is designed to establish the spatial ability and developed by Ekstrom (1976) According to Ekstrom, French and Harman (1979). According to the classification of McGee, solving the problems of SAT requires spatial visualization ability and in the present study, it is used as a measure of spatial visualization aptitude.

There are four different tests in SAT; Card Rotation Test (CRT), Cube Comparison test (CCT), Paper Folding Test (PFT) and Surface Development Test (SDT). Sample questions for each test are given in Appendix A.

Card Rotation Test (CRT): The test consists of true-false items that require *mentally rotating* of 2-D figures. For each figure, there were 8 turned figures to be compared and for each true item one gets 1 point. The test consists of two parts with 10 questions each so, the total score is 160. Participants were given 3 minutes to complete the each part of the test.

Cube Comparison Test (CCT): The test consists of true-false items that require *mental rotation* of cubes with different patterns on its faces. Each true answer is scored as 1 and there are 42 items, therefore the test is scored over 42. The test consists of two parts with 21 items each and each part was applied in 3 minutes.

Paper Folding Test (PFT): The test consists of multiple choice items that require *imagining the folding and unfolding* of pieces of paper. In each problem in the test the figures at the represent a square piece of paper being folded, and last of these figures has one or two small circles drawn on it to show where the paper has been punched. Each hole is punched through all the thicknesses of paper at that point. One of the five figures at the right of the vertical line shows where the holes will be

when the paper is completely unfolded. The test consists of two parts with 10 items in each and, the score of PFT is over 20. Participants were given 3 minutes to complete each part.

Surface Development Test (SDT): The test consist of matching items that require *mentally folding* the given 2-D figure to obtain the 3-D object. For each item, one should match 5 of the edges of the 2-D figure and the 3-D object obtained by folding the 2-D figure. The test includes two parts with 6 items in each and each true matching is one point so the score of SDT is over 60. Participants were given 6 minutes to complete each part.

The Spatial Ability Tests were translated in to Turkish and reliability coefficient of each test was calculated by Delialioğlu (1996). Reliability coefficients, number of questions and the durations for each test is given in Table 3.1.

Table 3.2. Reliability Coefficients, Number of Questions, Total Scores and Durations for the Tests of SAT (Delialioğlu, 1996).

Sub-Test	Cronbach Alpha	Number of Questions/Total Scores	Duration (min)
CRT	0.80	160	6
CCT	0.84	42	6
PFT	0.84	20	6
SDT	0.82	60	12

3.3.2. Task-Based Interview

This study intends to find out the spatial problem solving strategies of the participants while solving spatial visualization problems. Moreover, the difficulties they experience while solving spatial visualization problems are the other interest of the study. Therefore participants' verbal and non verbal behavior and interactions are analyzed to make inferences about the spatial visualization problem solving of the participants (Goldin, 2000). So, task-based interview is particularly the appropriate way of collecting data for the research questions of the present study. The research attention is focused on the participants' spatial visualization problem solving process during their engagement with the given tasks.

There are different types of spatial ability problems asked in the task-based interviews. To collect more detailed data for each kind, problems with different question type or difficulty levels are used. And the task-based interviews sessions are too long. Therefore, the task-based interviews were held at three different sessions. To prevent the participants memorizing the type of problems the periods between the interviews were tried to be set as long as possible. The first task-based interview was held at the beginning of the semester, just after applying SAT. The second task-based interview was held in the seventh week of the semester and the third and the last task-based interview was held at the end of the semester, after all the course sessions had finished. The three task based interviews were held in lo

In the selection of the problems of the task-based interviews, the main criterion is that they require basic spatial visualization abilities defined by McGee (1979). Those are; mentally manipulate, rotate, or invert a pictorially presented stimulus object. The spatial visualization problems asked in the task-based interviews and the spatial visual abilities which they require can be summarized as follows;

- Card Rotation problems require mentally rotating of a 2-D figure,
- Cube Comparison and 3-D Rotation problems require mentally rotating a 3-D object,
- Paper Folding problems require folding and unfolding of flat patterns,
- Surface Development problems require folding and unfolding of a given 2-D figure to obtain a 3-D object,
- Orthographic drawing problems require mental rotation and converting the given 3-D object to a 2-D structure.
- Isometric drawing problems require mentally converting a 2-D figure in to a 3-D object, and making a 2-D drawing a 3-D figure.

The problems asked in the task-based interviews are categorized in to two with respect to their required actions; *interpretation* and *construction* (Gorgorio, 1998). Card Rotation, Cube Comparison, Surface Development, Paper Folding, 3-D Rotation are the problems whose requiring action is interpretation. On the other hand Orthographic Drawing and Isometric Drawing are the problems whose required action is construction.

Additionally, the problems asked in the task-based interviews are categorized with respect to the required mental process to complete the task as; *rotation*, *manipulation* and *2-D drawing of 3-D object* problems. Card Rotation, Cube Comparison and 3-D Rotation problems requires mental rotation. On the other hand Surface Development and Paper Folding problems require mental manipulation and Orthographic Drawing and Isometric Drawing are 2-D drawing of a 3-D object problems. The categorizations of the spatial visualization problems asked in the task-based interviews were given in Table 3.2.

There are totally 25 problems in three task-based problems. Total scores for the problems are as follows;

- card rotation problems 19,
- cube comparison problems 5,
- paper folding problems 5,
- surface development problems 15,
- 3-D rotation 1,
- orthographic drawing 3
- isometric drawing 3.

The task-based interview questions were given in Appendix B.

Table 3.3. Categories of Spatial Visualization Problems of Task-Based Interviews

Required Ability	Required Action	
	<i>Interpretation</i>	<i>Construction</i>
	Cube comparison	
<i>Mental Rotation</i>	Card Rotation	
	3-D Rotation	
<i>Mental manipulation</i>	Paper Folding	
	Surface Development	
<i>2-D drawing of a</i>		Orthographic Drawing
<i>3-D object</i>		Isometric Drawing

In the three task-based interviews, participants were asked to solve the given spatial visualization problems or complete the spatial visualization tasks. The interviews were held by the researcher and during the interview sessions, the participants were

encouraged to talk about what they were thinking as they attempted to solve each problem. If their explanations were not enough, the researcher asked additional questions during and after problem solution. Task-based interview responses were collected as video recordings. By this way the participants' nonverbal behaviors, such as hand movements were also analyzed. Moreover, the drawings and rough draft of their written work were collected by the researcher for further analyses of their responses.

3.4. The Overall Procedure

The study was conducted during the spring semester of the 2007-2008 with five students of secondary or elementary mathematics education departments from a university in Ankara. Before conducting the study, the literature was reviewed and the problems of task-based interviews were prepared. In preparing the spatial visualization problems of task-based interviews, the researcher focused on the problems of Spatial Ability Test (SAT) and prepared two additional tasks, orthographic drawing and isometric drawing. These tasks were differing in their required action and required spatial visualization abilities.

At the beginning of the spring semester of 2007-2008 academic years, the students that took elective graduate courses offered by the elementary and secondary mathematics education courses were given information about the study and asked whether they wanted to be in the study voluntarily. Five of them accepted to be a part of the study and became the participants of this research.

Additionally, at the beginning of the study Spatial Ability Test (SAT) designed by Ekstrom (1976) was applied at the beginning of the semester. Ekstrom and his colleagues (1976) designed the SAT to measure the spatial ability aptitudes of people. According to their definitions of spatial visualization and spatial orientation factors of spatial ability, the tests of SAT were designed to measure both spatial

orientation and spatial visualization ability aptitudes. However, in the present study, the classification of McGee was used and the SAT problems require the basic abilities of spatial visualization defined by McGee (1979). SAT was administered by the researcher to the participants in the classroom where they took the course. Before the administration of the tests, the directions were explained to the participants. In addition, before administering each part of the SAT the participants were given instructions about how to answer the part. The information about SAT was given in detail in part 3.3.1.

Three task-based interviews were conducted during the semester to analyze the spatial strategies and the difficulties that participants experienced while solving spatial visualization problems. The first interview was conducted at the beginning of the semester just after the SAT was applied to the participants. The second task-based interview was conducted at the middle of the semester, after 6 weeks and the last task-based interview was conducted at the end of the semester, after all the sessions had finished. The task-based interviews were explained in part 3.3.2.

Task-based interview responses were collected as video recordings and these recordings were then transcribed by the researcher. Moreover, the products of the participants obtained in the task-based interviews were collected. Therefore, transcriptions of the interviews, SAT results of the participants and their drawings of the task-based interviews were the data sources collected during the study.

3.5. Data Analysis

In case studies, it is important to collect multiple data such as conducting interview, observation and examining documents (Yin, 1984) to increase the validity and reliability of the study. In the present study, the interviews, observation and the document analysis are used as data sources. The video recordings of the task-based

interviews are transcribed; the conversation and the observations are denoted in the transcriptions. The interview transcriptions are given in Appendix E.

The task-based interviews are analyzed according to “spatial strategies used in solving spatial visualization problems” and “difficulties in solving spatial visualization problems”. Responses of the participants to the interviews are analyzed through content analysis. Content analysis is a method that arranges the concepts in a logical way upon conceptualization of the data collected and explains the relationship between these concepts (Yıldırım & Şimşek, 2006). First of all, an initial category and code list based on the literature are formed for content analysis. Furthermore, new category and code additions are performed when required during review of the answers. New arrangement is made in order to finalize categories and codes once all answers were reviewed. As a result of the content analysis, concepts are presented in a descriptive way. Direct quotations from the interviews to increase the internal reliability of the study (Silverman, 1993) are included while reporting the results of the research. After all the codes are finished a doctorate student from the department of secondary science and mathematics checked the codes of two of the participants. Then the necessary changes in the codes were made and a full agreement with the second rater was reached. Additionally, all the participants checks the interview codes held with themselves and asked whether the codes and the inferences were matching with what they wanted to express, and according to their responses, the codes were reviewed.

3.5.1. Analysis of SAT

In the present study, at the beginning of the study Spatial Ability Test (SAT) were applied to the participants and the SAT results of the participants were used to define the spatial ability of the participants. To analyze the SAT scores in detail,

the numbers of unanswered and incorrect responses of the participants were also analyzed.

3.5.2. Analysis of Spatial Strategies of the Participants

In the present study spatial strategies that the participants used in solving spatial visualization problems are categorized as a synthesis of the definitions of different researchers who studies spatial strategies and the findings of the present study.

Previous research results reveal that there are two general kinds of solution strategies for spatial visualization. One is an *analytic* approach, which involves a systematic step by step approach that requires minimal visualization. The other is *holistic* approach that involves maintaining and using information about spatial relations among elements in the mental representation. However, these two approaches are accepted to be the poles of a continuum and there are *intermediate* strategies (Burin & Prieto, 2000; Eme & Marquer, 1999; Gluck & Fitting, 2003; Hsi et al., 1997; Schulz, 1991). In this study, the transcriptions of the task-based interviews are examined and the strategies that the participants used are categorized as analytic, holistic or intermediate strategies. Moreover, sub-categories are defined for each kind of problem of task-based interview, by using the previous definitions and the analysis of the results of the present study with respect to. The classification of the used strategies for each kind of spatial visualization problem is given in Table 4.3. Moreover, by analyzing the codes a pattern is intended to be found out with the used spatial strategies and the characteristics of the participants and the problems.

3.5.3. Analysis of Difficulties of Participants in Solving Spatial Visualization Problems

In the present study the difficulties of the participants experienced while solving spatial visualization problems are defined and categorized as a synthesis of the previous definitions in the literature and the findings of the present study.

Previous research results reveal that the limitations of individuals while solving spatial problems could be defined as failure to use the appropriate strategy and inadequate proficiency. In this study, the transcriptions of the task-based interviews were examined and the difficulties of the participants were categorized as; *limited flexibility* that is the difficulty in shifting the strategy, when one couldn't use the strategy s/he selected accurately or practically and *inadequate proficiency* which is the difficulty in using the selected strategy sufficiently.

In the coding of the interviews, if a participant had difficulty in the solution of the problem, then it was coded as inadequate proficiency. If then, she shifted her strategy then there was no coding, however, if she didn't shift her strategy and couldn't answer the problem then it was also coded as limited flexibility. The codes for the task-based interviews were given in Appendix C.

3.6. Validity and Reliability of the Study

The accuracy, dependability, and credibility of the study depend on the validity and reliability of it. The validity and the reliability of the present study are tried to be determined by using the strategies by Yıldırım and Şimşek (2006, p.264) as follows;

The internal validity or the *trustworthiness* of the study deals with how research findings match with reality and triangulation is one of the strategies. *Triangulation*

means using multiple data sources to confirm the data sources. In the present study task-based interviews, semi-structured interviews, observations and the documents were analyzed together to enhance the internal validity of this study

Another strategy for trustworthiness is long term or repeated observations. In the present study, three task-based interviews and a semi-structured interview are held.

“*Peer Examination*” and “*Member Check*” were also another two strategies in enhancing the trustworthiness. For peer examination, the codes were checked by a doctoral student at Secondary Science and Mathematics Education Department and the codes that are not matching are reanalyzed until the codes were fully agreed. For Member Check the participants are asked to check if the codes and the inferences from the codes are the same as what they implemented and replicated with respect to their comments.

The *transferability* is concerned with the extent to which the findings of the study can be applied to other situations. Purposive sampling was one of the ways to provide transferability, in the present study the participants were described with its typical and different with the other teacher candidates.

Another strategy is for the researcher to give rich, *thick description* of the results. The researcher tried to provide enough description about the participants, the problems, the data collection methods and the methods for analysis so that “readers will be able to decide how well the research study matches the research situation”.

Reliability or *consistency* of the study refers to the extent to which research findings can be replicated (Yıldırım & Şimşek, 2006, p259). The criteria for the selection of participants and spatial visualization problems, the spatial visualization problem solving activities, the coding systems to analyze the interview data and the methods that were used in this study were introduced

3.7. Assumptions and Limitations

In this section, the main assumptions and the limitations for the present study are given.

3.7.1. Assumptions

The main assumptions of the present research study are the following;

- All participants answered the measurement instruments accurately and sincerely.
- Participants are able to understand the test items correctly.
- The Spatial Ability Test (SAT) was applied in the given time periods.
- The interviews were conducted to all of the participants under the standard conditions.

3.7.2. Limitations

The limitations of the present research study are the following;

- This study is limited to five adults studying elementary and secondary mathematics education at a university in Ankara at the spring semester of 2007-2008 educational years.
- The participants are not at the same grade level, there are under graduate and graduate students.
- All of the participants are female so the effect of gender was neglected.

CHAPTER 4

RESULTS AND CONCLUSIONS

In this chapter, I will explain the results and conclusions of the present study researching the following questions;

- What spatial strategies do adults use to solve spatial visualization problems?
- What are the difficulties that adults experience while solving spatial visualization problems?

This chapter summarizes the findings of the research study under two main sections and related subsections. The first section gives a general overview about the participants spatial ability by the analysis of spatial ability test (SAT). The other two sections deal with the two research problems. The second section summarizes the findings of this study about the spatial strategies that the participants use while solving spatial visualization problems. This second section is then divided in to three subsections: holistic strategies, analytic strategies and intermediate strategies. Each subsection is further subdivided in to headings. In the third section, the results of the study about the difficulties that participants experience while solving spatial visualization problems are analyzed. The third section is also subdivided in to two subsections; inadequate proficiency and limited flexibility. In the following section 4.1, participants SAT results are analyzed in

detail rather than a statistical analysis to have a general understanding of the participants' spatial ability levels.

4.1. Participants' Spatial Ability Test (SAT) Scores

In this section the scores of the participants in the spatial ability test is analyzed in detail. In the analysis of SAT, not only the true responses of the participants but also the number of their incorrect responses and the number of problems that they didn't answer are also considered. The scores of the participants, the number of their incorrect, unanswered and correct responses are analyzed to define the spatial aptitudes of them. Additionally, in the further parts these results are analyzed with the participants' task-based interview results to explain the research problems.

The detailed SAT result table for each participant that shows the number of correct, incorrect and unanswered responses of the participants is given in Appendix D. Additionally; Table 4.1 summarizes the scores of each participant for each part of SAT. As mentioned before SAT has four tests that are used to assess the spatial visualization ability; Card Rotation Test (CRT), Paper Folding Test (PFT), Cube Comparison Test (CCT) and Surface Development Test (SDT). As one can see on Table 4.1, the score of CRT is 160, PFT is 20, CCT is 42 and SDT is 60. Therefore, the total score of SAT is 282.

Table 4.1. The Scores of Participants in Spatial Ability Tests (SAT)

Participants	Tests of SAT				Total SAT
	Card Rotation Test (CRT)	Paper Folding Test (PFT)	Cube Comparison Test (CCT)	Surface Development Test (SDT)	
P ₁	58	10	10	9	87
P ₂	123	15	31	38	207
P ₃	108	17	20	33	178
P ₄	99	14	12	33	158
P ₅	77	12	24	9	122
Total Score	160	20	42	60	282

When the scores of the participants are analyzed, it is seen that P₁ has the lowest scores in all of the tests of SAT. In CRT she has 58 correct answers where the number of unanswered questions is 91. In PFT she could manage to answer 16 items and only 10 of them are correct. Similarly in the CCT she has 10 correct answers and 26 unanswered questions. Lastly in the SDT she could only consider four of the figures and matches 19 items, 10 of her answers are incorrect. When the answers of P₁ are analyzed it could be seen that the number of her incorrect answers is not higher than the other participants (see Table 4.1.). On the other hand, she has rather high number of unanswered questions. In all of the tests her unanswered questions are the ones at the end of the tests, which is she couldn't manage to finish answering all of the test items. This tells us that, she couldn't solve the tests as fast as required and she has problem with the time. Moreover, the questions are getting more difficult from beginning to end; therefore her difficulties in solving complex questions could not be considered.

P₂ has the highest scores in the three of the tests, only in the PFT; she has the second highest score as seen in Table 4.1. The number of her unanswered questions is quite low. In most of the tests she almost finishes to answer all of the questions except the CRT. In CRT, even she couldn't finish the entire test; she has the lowest number of empty responses among the other participants. She has 29 unanswered questions and her score is 123 over 160. In CCT she has only 4 unanswered questions and 31 correct answers. In PFT also she has 3 incorrect and 2 unanswered questions. In the PFT she has 6 empty items but the number of incorrect answers is 16, which is quite high.

If Table 4.1 is analyzed it is concluded that P₃ has scores between the highest and the lowest scores and she could answer more than half of the questions correct, the number of her incorrect answers is low but she has higher number of unanswered questions than P₂. In CRT her score is 108 and she has only 4 incorrect answers. In CCT her score is 20 and the number of her incorrect answers was 5. In PFT, she answered all of the questions and she had the highest score for this test, her score is 17. The number of her incorrect responses is mostly the lowest in the tests; only in the SDT she has high number of incorrect responses, 19 of her 52 answers are incorrect. In the tests of SAT, almost all of the unanswered questions are at the end of the tests except the SDT. Therefore, she also couldn't finish the tests in required time. In SDT, she tries to answer all of the questions but she couldn't manage to find the correct answers. Her score of SDT is 33.

P₄ also has scores between the highest and lowest scores, and she could answer more than half of the questions correct. However, she has higher number of incorrect responses than P₃ (see Table 4.1). Especially, CCT score of P₄ is significantly low and the number of unanswered questions is high. Her score is 12 and she couldn't manage to answer 20 of the items, which is nearly the half. In CRT her score is 99 and she has 7 incorrect responses. In PFT she has only 2 incorrect answers and her score is 14. In SDT her score is 33 as P₃ but the number

of her incorrect answers is lower, she has 12 unanswered items. As most of other participants, in all of the tests, her unanswered questions are at the end of the test that is she couldn't finish answering the whole test questions in required times either.

Lastly, when scores of P₅ are analyzed from Table 4.1, it is seen that she has also very low scores as P₁. However, different than P₁ her scores are not so low for all tests. In CRT, she couldn't give any answer to nearly half of the questions; and the unanswered questions are at the end of the test. Her score is 77 and she couldn't manage to answer the 79 of the questions. Therefore, required speed is a problem for her. This also leads the problem that, she couldn't consider the difficult and more complex questions. In CCT, P₄ answers nearly all of the questions; she has only 3 unanswered items. Even she has a high number of incorrect responses; she has higher score than the three other participants, her score is 24. In PFT, she has also only 2 unanswered items, but she has 6 incorrect responses. In the SDT P₅ considers only three of the figures where the test concludes 12 figures to be considered and she couldn't find all of the matching in the figures she considers. She has 10 responses where 9 of them are correct. The number of her unanswered items is the 50. Therefore she couldn't answer nearly the entire test.

4.2. Participants' Spatial Strategies

As mentioned above, this study attempt to provide enlightenment of adults' spatial strategies while solving spatial visualization problems. The strategies and sub strategies of participants are intended to be defined by the ways of using these strategies. In this section the findings of the study about the strategies of adults with respect to different kinds of spatial visualization problems and different ways of using the strategies are tried to be summarized. The task-based interview transcriptions of the participants are analyzed in order to define and categorize the spatial strategies of the participants.

Table 4.2. The Categorization and Number of Problems in the Three Task-Based Interviews

Required Action	Interpretation				Construction			
	Mental Process		Manipulation		2-D Drawing of 3-D Object			
	Rotation							
Problems	Card Rotation	Cube Comparison	3-D Rotation	Paper Folding	Surface Development	Orthographic Drawing	Isometric Drawing	
Number of Problems	5	5	1	5	8	3	3	

In the three task-based interviews, totally 25 spatial visualization problems are asked to the participants as mentioned above. The spatial visualization problems asked in the task-based interviews are categorized in two different ways. First of all, there are two kinds of problems with respect to their required action; interpretation and construction problems. Secondly, there are three kinds of problems with respect to the required thought process; mental rotation, mental manipulation and 2-D drawing of 3-D object. 11 of the 25 problems require mental rotation, 8 of them require mental manipulation and these 19 problems could be categorized as interpretation type of problems. 6 of the problems involved 2-D drawing of a 3-D object which could be accepted as construction type problems (see Appendix B). The categorization of problems and the number of problems in each category are given in Table 4.2.

The review of the related literature shows that in the solution of spatial visualization problems individuals use three main strategies: holistic, analytic and

intermediate strategies. In the following three sections the strategies used by the participants and the ways of using those strategies are tried to be defined in detail and categorized with respect to these three main categories. The first main category is the holistic strategies. In the following sections the holistic strategies used by the participants during the task based interviews are tried to be defined and exemplified.

4.2.1. Holistic Strategies

In this part, the holistic strategies used by the participants will be given. When the related literature is reviewed it is seen that holistic strategies are accepted to involve representing and manipulating spatial information “in a spatial way,” that is, maintaining and using information about spatial relations among elements in the mental representation (Glück & Fitting, 2003). When the results of the present study are analyzed it is seen that participants of the present study also use holistic strategies in the solution of the problems asked in the task-based interviews. Additionally, the analysis of the responds of the participants reveals that holistic strategy is used in two different ways with respect to the required mental process to solve the problems. Two different ways of using holistic strategies are mental rotation and mental manipulation strategies and they are accepted as two sub-strategies of holistic strategy.

4.2.1.1. Mental Rotation Strategy

In this part mental rotation strategy, which is a sub-strategy of holistic strategy, is presented with its examples of use and definition. In the present study, there are three kinds of rotation problems: Card Rotation, Cube Comparison and 3-D Rotation problems. When the transcriptions of the task-based interviews are analyzed, it is concluded that one of the strategies used in solving problems requiring rotation is mental rotation strategy. Mental rotation strategy can be

defined as imagining the rotation of the object and using this strategy involves firstly encoding one or more elements of the given figure and then visualizing the movement of the encoded configuration. Then the mental image resulting from the rotation is compared to the visual image of the test figure (Eme & Marquer, 1999). There were 5 card rotation problems in the task based interviews and some of the explanations of the participants about how they solve these problems are as follows.



Figure 4.1. Card Rotation problem of the 1st task-based interview

For the card rotation problem of the first task-based interview given above P₁ explains her solution as that;

P₁: I tried to rotate the figure in my mind.

Similarly, P₄ and P₅ explain their way of answering the same problem as;

P₄: I tried to imagine the rotation. For instance this is not the same; the long part changed its place.

P₅: I mentally do such problems. I tried to imagine the rotation.

Another kind of rotation problem is cube comparison problems. In the three task-based interviews there were totally five cube comparison problems. The strategies used by the participants in solving card rotation problems are similar to the ones in card rotation problems and imagining the rotation is one of the strategies used.

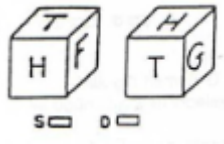

Figure 4.2. 1st Cube comparison problems of the 1st task-based interview

P₄ paraphrases how she thinks while solving the cube comparison problem in Figure 4.2 as;

P₄: First of all to understand the direction of the rotation I looked at the faces with the same pattern. For example in this one I should firstly turn right than upwards. Then I tried to imagine how would be other faces as a result of this rotation.

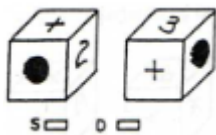

Figure 4.3. 2nd Cube comparison problems of the 1st task-based interview

P₅ illustrated her way of solving the problem in Figure 4.3. as;

P₅: I looked at both of the cubes and try to find the turns by looking at the patterns, then rotate the first figure. If the pattern is symmetric like O, than I control the asymmetric ones such as “2”.

The third kind of rotation problems is 3-D rotation problem and it is asked in the third task-based interview.

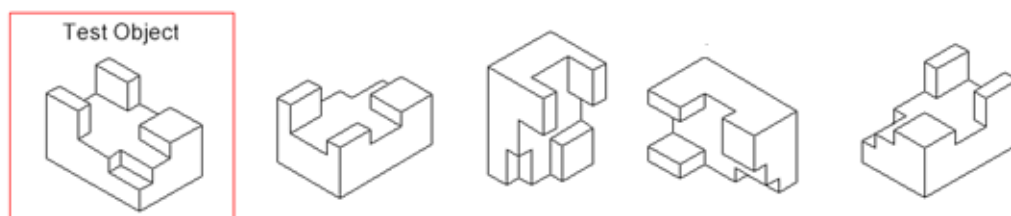

Figure 4.4. 3-D rotation problem of the 3rd task-based interview

P₃ and P₄ try to imagine the rotation and they explain their strategies as;

P₃: I imagine the turning. This one is different from the original figure because the positions of the asymmetric corners are not the same.

P₄: I tried to rotate the object in my mind; in this last one the corners changed their positions so it is not the same.

When the paraphrases of the participants about what they think while solving the rotation problems are analyzed, it is revealed that one way of their solution is imagining the rotation. This way of solution is called as mental rotation strategy. As seen from the above examples of participants' expressions we can conclude that while using mental rotation strategy, participants encode elements of the rotated figure. Then they try to find the direction of the rotation and imagine the rotation of the encoded parts. And lastly they controlled their solutions with the test object.

4.2.1.2. Mental Manipulation Strategy

This part of the study presents the mental manipulation strategy which is a sub-strategy of holistic strategy. The definition and the ways of using mental manipulation strategy are given in detail. The spatial visualization problems used in the present study that are requiring manipulation are Paper Folding and Surface Development problems. The results of the study show that one of the strategies used by the participants to solve these manipulation problems is mental manipulation strategy. When the transcriptions of the task-based interviews held by the participants, it could be concluded that, this strategy involves encoding one or more elements of the given figure and then visualizing the required manipulation. Then the mental image that is the result of the manipulation was compared with the test object.

As mental manipulation problems there were 5 paper folding tasks and 3 surface development tasks in the task-based interviews.

In paper folding problems, the main step of solving the problems is to understand the folding and then finding the folded edge. When the participants explained their thought process for this part of the problem it is seen that there are two ways of using mental manipulation: imagining the folding and imagining the sequence.

4.2.1.2.1. Imagining the Folding

In paper folding problems, all of the participants mention that they try to imagine the folding to find the places of punched holes. On the other hand as the folding gets complex they try to imagine the unfolding. In other words they begin with the folded and punched figure and then by unfolding it they try to obtain the first unfolded figure.



Figure 4.5. 1st Paper folding problem of the 1st task-based interview

P₁ states her way of thought for the problem in 4.5 as;

P₁: First of all, I found the place of the original point. Then by unfolding the folded paper I tried to find the folding edges.

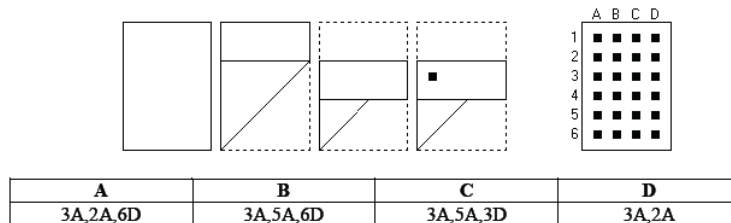

Figure 4.6. 3rd Paper folding problem of the 2nd task-based interview

Similar to P₁, P₂, P₃ and P₅ also mention that they try to imagine the folding or unfolding. For the paper folding problem given in 4.6 she says,

P₂: I take the symmetry of the holes with respect to the folding edges. If there are more than one folding, than I start from the end, and by unfolding the figure I try to take the symmetries.

P₃: there are two folding here, I start from the last one and try to unfold it in my mind.

P₅: I tried to find the symmetry of the points and I started from the last folding and come back by unfolding. I may neglect the folding where the underneath of the paper is empty.

4.2.1.2.2. Imagining the Sequence

In paper folding problems, to understand the folding of the given figure with more than one folding, understanding the sequence of the folding is also important. The participants paraphrase that to understand the folding they try to imagine the sequence of the folding also. The following problem 4.7 is asked in the first task based interview and requires a more complex folding then the other paper folding problem. The participants explain their solution for this problem as follows:

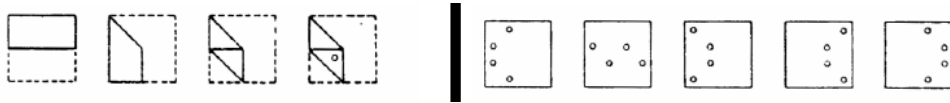

Figure 4.7. 2nd Paper folding problem of the 1st task-based interview

P₁: I should understand the folding first; I confuse which folding is the first. (she tries to repeat the folding with her hands)

P₂: the folding gets more complicated, I should understand the folding first. Now the first folding is like this and then the second one (she repeats the folding with her hands)...and it is punched here.

P₄: In this problem there is a lot of folding so I start from the last one and try to unfold the figure in my mind. But the sequence of unfolding is important. I try to visualize the folding one by one.

Surface development problems are the other kind of problems that require mental manipulation. To respond surface development problems most of the participants try to imagine the folding of the first figure to obtain the folded object or vice versa. In other words some of them try to unfold the second folded object to obtain the first figure. This is also the use of mental manipulation strategy with the way of imagining the folding.

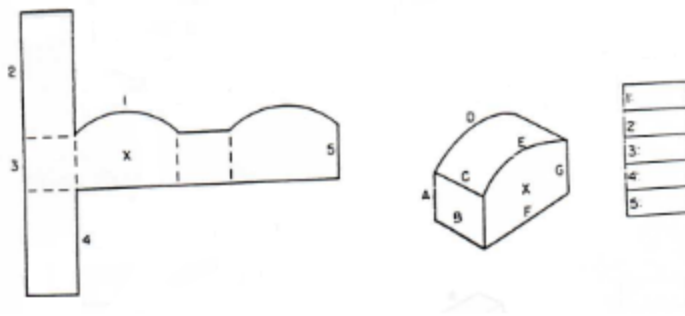

Figure 4.8. 1st Surface development problem of the 1st task-based interview

As an example for the problem 4.8, P₁ and P₃ explain their strategies as;

P₁: I tried to imagine the folding. If I fold this part outside, than these two edges will be combined. And this will be the outer surface of the object.

P₃: I tried to imagine the folding, this part will be folded like this (showed with her hands). I tried to join the edges.

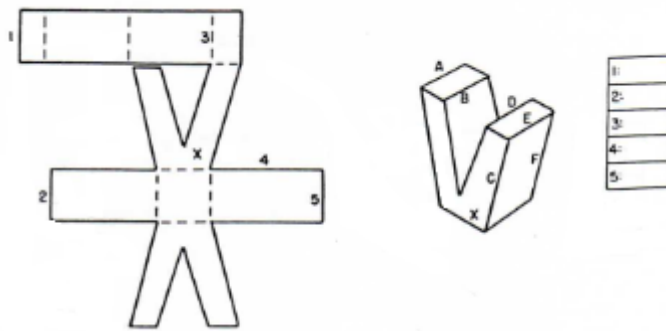

Figure 4.9. Surface development problem of the 3rd task-based interview

Similarly P₄ and P₅ explain their thoughts for the solution of the problem 4.9 as;

P₄: I tried to find out which edges will come together (she repeated the folding with her hands)

P₅: I firstly matched the faces of the folded and unfolded figures marked by X, and then I try to unfold it in my mind.

The analysis of the transcriptions of the task-based interviews shows that while using mental manipulation strategy, participants encoded the elements of the given figure. Then, they try to understand the required manipulation, such as folding or unfolding, and they try to imagine the required manipulation. Lastly, they controlled the encoded parts with the test object. In mental manipulation strategy they use they use two ways; imagining the folding and imagining the sequence.

4.2.2. Analytic Strategies

In this part, the analytic strategies used by the participants will be given. The findings of the previous studies on the subject show that one of the strategies used by individuals while solving spatial visualization problems is analytic strategy.

Analytic strategies are the strategies that involve a systematic step by step approach that requires minimal visualization (Hsi et al., 1997). The results of the present study also confirm that analytic strategies are frequently used by the participants in all kinds of visualization problems. The present study intends that there are two kinds of analytic strategies used by the participants; key feature and counting strategies. These strategies are accepted as sub-strategies of analytic strategy.

4.2.2.1. Key Feature Strategy

The results of the present study show that one of the strategies used in the spatial visualization problems whose required mental process is rotation and manipulation, the participants prefer using key feature strategy. Key feature strategy requires the analysis and rotation or manipulation of important features of the stimulus object (Schulz, 1991) and it is a kind of analytic strategy. When the transcriptions of the task-based interviews held by the participants are analyzed, it is concluded that while using the key feature strategy participant use two different ways: comparing the relative positions and comparing the relative distance.

4.2.2.1.1. Comparing the Relative Positions

The results of the present study reveal that in the solution of the spatial visualization problems whose requiring mental process is manipulation or rotation, participants use key feature strategy by the way of comparing the relative positions of the patterns of the given figure. As an example, in rotation problems participants mention that they find the asymmetric parts of the figure and then they control the positions of these parts with respect to each other.



Figure 4.10. 2nd Card rotation problem of the 1st task-based interview

P₂ and P₃ explain their strategies for the card rotation problem given in Figure 4.10 as;

P₂: I took the asymmetric parts of the figure and fixed their positions with respect to each other.

P₃: All has an asymmetric part. For instance, in this problem, the thin and long part should always be on left. I took distinct points, and then control their positions with respect to each other.

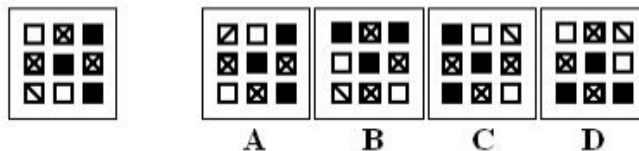

Figure 4.11. 1st Card rotation problem of the 2nd task-based interview

Similarly for the card rotation problem given in Figure 4.11 P₂ and P₃ mention;

P₂: I take one reference point but it is not enough I will use one more. Now I will control the positions of them with respect to each other.

P₃: I choose distinct points and control their positions with respect to each other. In this problem on the left there should be two white squares.

For the cube comparison problems such as in the Figure 4.2 participants control the positions of the patterns on the faces of the given cubes;

P₂: If the pattern is symmetric like O then I control the position of that face, if it could go there. And then I take two asymmetric parts and fix their positions.

P₅: I look at the patterns. If the pattern is symmetric then it will go everywhere. Then I controlled the positions of the asymmetric figures like T.

Similar way of using key feature strategy is also used in the 3-D rotation problem. As an example P₂ paraphrases her strategy for the solution of the problem given in Figure 4.4 as;

P₂: In these kinds of problems, I controlled asymmetric parts of the figures. The positions of this square tip and the hole with respect to each other should remain the same.

Surface development problems are the manipulation problems that the participants choose key feature strategy with the way of comparing the relative positions. Especially for the surface development problems asked in the second task-based interview most of the participants use this strategy.

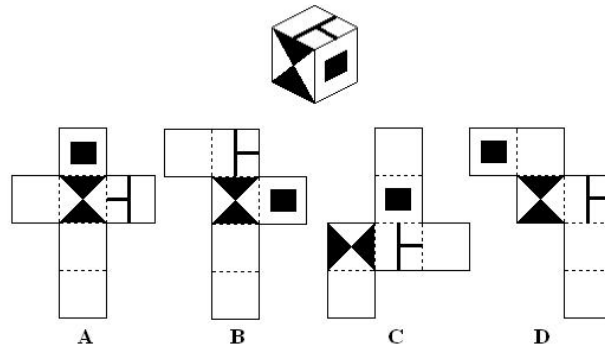

Figure 4.12. 2nd Surface development problem of the 2nd task-based interview

For example the explanations of the participants for the problem given in Figure 4.12 are as follows;

P₂: I control whether the patterns on the faces follow each other.

P₃: If the patterns on the faces of the cubes are asymmetric than I will control their positions. For instance, in this second problem the short part of T and the square should be on the same hand and on the left of the long part of T there should be the triangles

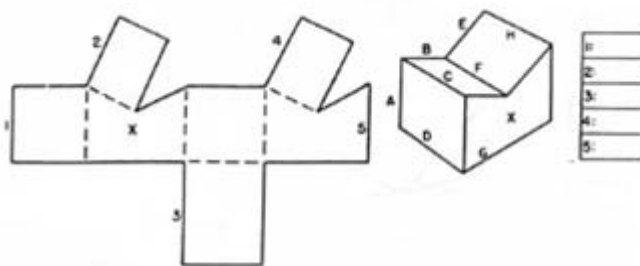

Figure 4.13. 2nd Surface development problem of the 1st task-based interview

For the surface development problems as in 4.13 also some of the participants use the way of comparing the relative positions of the edges with respect to each others. For instance;

P₂: I didn't look at the whole figure. For instance this edge is long so it should match with the long edge. I always find a reference point and then I controlled with respect to it... It is very difficult for me to imagine the folding. Thus, I think partly. I try to find reference points and I try to match the asymmetric edges.

P₄: I try to imagine the folding. I match the similar faces, and also I match distinct edges. I fold this face like this then the side faces should be these (she painted the faces of the figure to be folded and the faces of the object to match)

P₅: I started from the folded object and try to find the edges around the face marked by X.

4.2.2.1.2. Comparing the Relative Distances

The analysis of the results of the present study shows that in the solution of the spatial visualization problems whose requiring mental process is rotation, participants use key feature strategy by the way of comparing the relative distances between the distinct parts of the given figure.

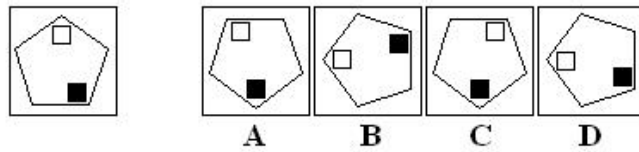

Figure 4.14. 2nd Card rotation problem of the 2nd task-based interview

In the card rotation problem given in Figure 4.14, P₁, P₄ and P₅ explain their way of thought as;

P₁: I control the positions and the distances of the parts. The black square should always be on the right and 2 units away from the white one.

P₄: I establish distinct parts and they should be on the same direction with the same distance. I control these.

P₅: In this problem the distance between the squares should remain the same.

The results of the analysis of the data shows that, in the solution of rotation and manipulation problems participants use key feature strategy as an analytic strategy. In this strategy rather than imagining the required manipulation, participants encoded distinct parts of the objects that can be called as key feature. Then, they try to match the key feature in both original and manipulated object. While using key feature strategy, participants use two different ways; comparing the positions and comparing the relative distance of the selected key features.

4.2.2.2. Counting Strategy

The analytic strategies used in the problems involving 2-D drawing of a 3-D object by the participants is called as counting strategy in the present study. Counting strategy is accepted to involve a systematic, step by step approach that requires minimal visual rotation. In other words, rather than imagining the whole 3-D object or the isometric drawing, it requires counting the number of cubes and matching these numbers in their drawings. For example, a student using counting strategy for cube counting would count the cubes systematically from left to right, and top to bottom. When the task based interview responses of the participants are analyzed it is seen that participants use counting strategy in three ways; counting the number of cubes, computing the number of cubes and using drawing techniques.

4.2.2.2.1. Counting the Number of Cubes

In the three task-based interviews there are three orthographic drawing tasks. The results of the study show that while completing the orthographic drawing tasks participants mostly use counting strategy by counting the number of cubes on each row and column and then they draw a square for each cube.



Figure 4.15. Orthographic drawing problem of the 2nd task-based interview

For instance, for the problem given in Figure 4.15 participants explain their work as;

P₁: Let say this face is side and this one is the front. Then I count and draw.

P₂: It is easy to draw these, I count and then draw.



Figure 4.16 . The orthographic drawing of P₂ in the 1st task-based interview

4.2.2.2.2. Computing the Number of Cubes

There are three isometric drawing problems in the three task-based interviews. Responding each isometric drawing problem asked in the task based interviews requires two steps. First step involves imagining the 3-D block figure by using the top, side and front views. Then in the second step, one should draw the obtained block figure on to the isometric dot paper.

When the transcriptions of the task-based interviews are analyzed for the first step of isometric drawing problems, it is seen that participants have difficulty in imagining the whole object. They use counting strategies. The way of using counting strategy in obtaining the 3-D block figure by using its front, top and side views is computing the number of cubes on each row or column by using the top, side and front views.

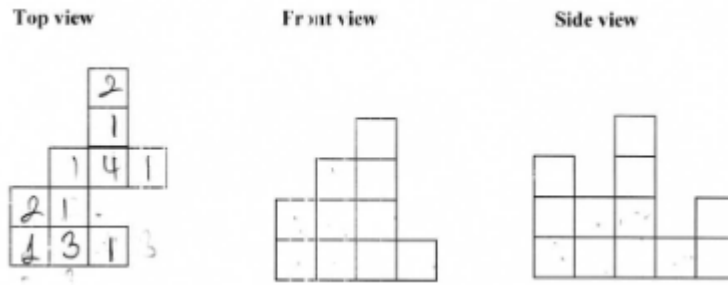

Figure 4.18. P₅ wrote the number of cubes on the top view

4.2.2.2.3. Using Drawing Techniques

The second step of isometric drawing task is drawing the block figure on an isometric dot paper. Before drawing on isometric dot paper, all of the participants draw a unit cube and then try to identify how to draw cubes upwards and backwards. Then with the number of cubes on each column and layer that they have already determined, they use drawing techniques to draw upwards and backwards. For instance;

P₂: I understand how to draw backwards and upwards, so it is not difficult for me to draw. The whole figure will come out at the end. Now I control the number of cube.

P₃: I will draw the first layer at the beginning. Some of the edges may not be seen at the end than I will erase them. To perceive my drawing better I shade its top faces

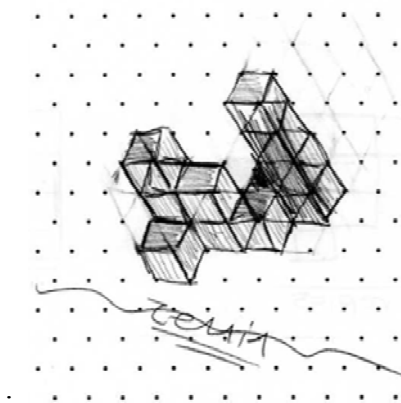

Figure 4.19. The isometric drawing of P_3 in the 2nd task-based interview

P₄: I will draw the first layer beforehand, than I will draw the upper layers. When I draw the upper layers some of the cubes on the back won't be seen, I will erase them. I thicken the edges and shade the top faces to avoid being unconfused. I think we draw backwards like this; I confuse it by drawing upwards.

The analysis of the participants responds show that counting strategy is a frequently used strategy in orthographic and isometric drawing tasks. In orthographic drawing problems the way of using counting strategy is counting the number of cubes on each row and column. In isometric drawing problem, to obtain the figure, the participants compute the number of cubes by matching the number of cubes from the top, front and side views. Additionally, while drawing objects on the isometric dot paper, they use drawing techniques to draw upwards and backwards with the given number of cubes.

4.2.3. Intermediate Strategies

In this part, the intermediate strategies used by the participants will be given. Analytic and holistic strategies should not be viewed as mutually exclusive

categories; rather they are the poles of a continuum and the related literature shows that there are intermediate strategies. The findings of the present study reveal that participants of the present study also use intermediate strategies. The intermediate strategies used in this study are defined as partial rotation, partial manipulation and pattern-based strategies.

4.2.3.1. Partial Rotation Strategy

The results of the present study show that one of the strategies used by the participants in solving the spatial visualization problems whose requiring mental process is rotation is partial rotation strategy. This strategy involves partitioning the rotated figure and then imagining the result of rotation for each part separately (Eme & Marquer, 1999). The participants of the present study used this strategy in the problems requiring the rotation of 3-D objects such as cube comparison problems and 3-D rotation problem. As an example, for the cube comparison problem given in Figure 4.2, P₂ defines her strategy as;

P₂: In this test I fixed a pattern let say H, then I looked what was near H and controlled those two faces, if it was not enough I controlled the third face. If the pattern was symmetric, then I controlled the places of the patterns. I looked whether one could come to the top or not, for example.

Therefore, rather than imagining the rotation of the whole object, she tries to imagine the rotation of the faces of the cube one by one. In the 3-D rotation problem given in Figure 4.4, different from the other participants, P₁ tries to imagine the rotation of the parts of the figure separately;

P₁: I rotate this pit corner first, and then this pock corner should be here.

Thus, while using partial rotation strategy, participants try to imagine the rotation of parts of the given figure, rather than imagining the rotation of the whole object.

4.2.3.2. Partial Manipulation Strategy

When the transcriptions of the task based interviews of the participants are analyzed, it could be seen that in manipulation problems partial manipulation strategy is also used as a third kind of strategy. Partial manipulation strategy requires imagining the required manipulation part by part. While using partial manipulation strategy participants use two different ways; symmetry rule and partial folding.

4.2.3.2.1. Symmetry Rule

In paper folding problems, all of the participants' main strategy used by the participants is to find the folding edges and then taking the symmetry of the given hole with respect to those edges which is called as symmetry rule in the present study and it is a way of partial manipulation strategy. P₁, P₂ and P₃ explain their strategies for the paper folding problem in Figure 4.7 as;

P₁: To find the places of the holes, I took the symmetry of the given point with respect to the folded edge.

P₂: The holes should be symmetric with respect to the folded edges.

P₄: Firstly I looked at the folding edge, then I took the symmetry of the point with respect to that edge. To understand the folding I started from the end and tried to imagine the unfolding.

4.2.3.2.2. Partial Folding

In surface development problems also in some cases, rather than imagining the folding of the whole object participants try to fold the figure part by part, which is called the partial folding way of using partial manipulation strategy. For example P₄ and P₃ explained their strategies for the surface development problem given in Figure 4.9 that;

P₄: I try to imagine the folding. I match the similar faces, and also I match distinct edges. I fold this face like this then the side faces should be these (she painted the faces of the figure to be folded and the faces of the object to match)

P₃: I find it difficult to imagine the folding of the whole object. So I tried to match part by part. If I fold this figure, this corner will come here and this edge will go there (she showed the folding with her hands).

The findings of the present study reveal that for the manipulation problems participants use partial manipulation strategy which could be accepted as an intermediate strategy. Partial manipulation strategy involves manipulating the given stimulus objects part by part rather than imagining the manipulation of the whole object. In the present study the participants use partial manipulation strategy in two ways. In paper folding problems participants use symmetry rule and in surface development problems they use partial rotation way of partial manipulation strategy.

4.2.3.3. Pattern-Based Strategy

In the orthographic drawing and isometric drawing tasks, the most frequently used strategy is the pattern-based strategy. This strategy involves abstracting the problem into familiar elements such as single columns or planes of blocks and

reducing the solution to cases previously solved (Hsi et.al., 1997). In the present study the participants reduce the solution in to familiar cases in two ways; abstracting the figure and painting.

4.2.3.3.1. Abstracting the Figure

In the three task-based interviews, there are 6 problems that require 2-D drawing of a 3-D object. 3 of the problems require orthographic drawing of a given object that is built by unit cubes, those are top view, side view and front view drawings of the given block figure.

In orthographic drawing problems participants firstly decide which face would be the side view and which face would be the front view. Then they try to abstract the elements of the 3-D object in to simpler elements such as rows or columns. Then they count the number of cubes on each row and column and draw which is accepted as the way of abstracting the figure in the present study. There are no other strategies for such questions.

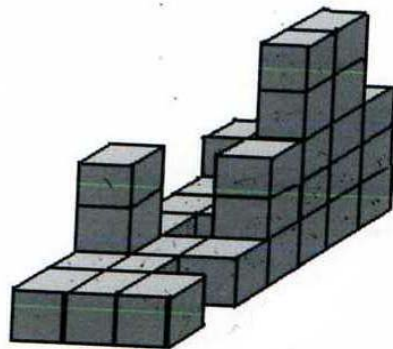

Figure 4.20. Orthographic drawing problem of the 3rd task-based interview

For the orthographic drawing problem given in Figure 4.20, participants explain their solutions as follows;

P₁: Let's say here is the front and the other one is the side. Then I will count the number of cubes and then draw.

P₂: I draw by counting the number of cubes easily.

P₄: If I say here front then this face is the side, then I count the number of cubes and draw.

When the transcriptions of the task-based interviews are analyzed for the first step of isometric drawing problems participants have difficulty in imagining the whole object. The participants use the idea that top view is the bottom of the block figure, so it could be accepted as the first layer which can be accepted as a abstracting the figure way of pattern-based strategy.

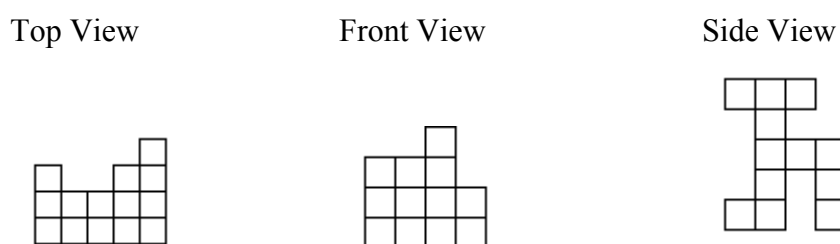

Figure 4.21. Problem 18: Isometric drawing problem

As an example P₂ explains her strategy for the isometric drawing problem given in Figure 4.21 as follows;

P₂: Now, I will obtain the first layer. Then I will match the side and front views to obtain the other layers. I will draw up with respect to the front view then I will take out the excess ones with respect to the side view.

4.2.3.3.2. Painting

In the present study while drawing 3-D block figures on isometric dot paper one of the main strategies used is shading or painting the faces and thickening the edges of the cubes that should be seen on their drawings to understand their drawings. This is accepted as the painting way of pattern-based strategy. The participants explain their studies on isometric drawing as follows;

P₁: To understand my drawing I want to shade the upper faces of the cubes.

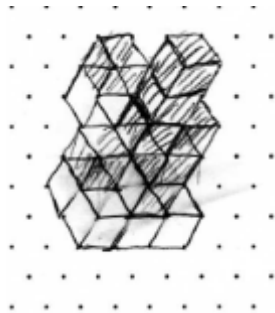

Figure 4.22. Isometric Drawing of P₁ in the 2nd task-based interview

P₃: If I start drawing from back then I will understand the unseen ones better. To understand the cubes that can be seen I paint the cubes that can be seen.

P₅: Now I will draw upwards like this and backwards like this (she showed by drawing around a unit cube). Now I will start with this front column. I will paint the faces to understand my drawing.

The findings of the present study show that in orthographic and isometric drawings participants use pattern-based strategy. In other words, they try to reduce the problems in to familiar elements such as single columns or planes of blocks. The participants of this study use pattern-based strategy in two ways; abstracting the figure and painting their drawings.

Table 4.4 summarizes the strategies of the participants with respect to the problems. Additionally the sub-strategies and the ways of using the sub-strategies used by the participants are also given in Table 4.4 with the number of their repetitions.

From Table 4.3 it could be concluded that the participants of the study used three main strategies; holistic, analytic and intermediate strategies. The sub-strategies of the holistic strategy are; mental rotation and mental manipulation. For the problems whose requiring mental process is rotation, the used holistic strategy is mental rotation. On the other hand for the manipulation problems, used holistic strategy is mental manipulation. While solving manipulation problems participants use mental manipulation strategies in two ways; by imagining the folding and by imagining the sequence of folding.

The sub-strategies of the analytic strategy are; key feature and counting strategies. In solving the rotation and manipulation strategies participants use key feature strategy by two different ways; comparing the relative positions and comparing the relative distance of the parts of the given figures to be rotated or manipulated. On the other hand in orthographic drawing and isometric drawing problems participants use counting strategy. For orthographic drawing they use the way of counting the number of cubes. Moreover in isometric drawing problems, to obtain the 3-D block figure they use the way of computing the number of cubes on each of the columns and rows of the 3-D block figure and use the way of using drawing techniques while drawing the figure they obtain on the isometric dot paper.

Table 4.3. The Number of the Repetition of the Strategies used by the Participants in the Three Task-Based Interviews

		Spatial Strategies										
		Holistic			Intermediate				Analytic			
<i>Sub Strategies</i>		<i>Mental Rotation</i>	<i>Mental Manipulation</i>	<i>Partial Rotation</i>	<i>Partial Manipulation</i>	<i>Pattern-Based</i>	<i>Key Feature</i>	<i>Counting</i>				
<i>Ways of Using Strategies</i>												
Imagining the rotation												
Imagining the folding and unfolding												
Imagining the sequence of folding												
Rotating the parts of the figure												
Symmetry rule												
Partial folding												
Painting/shading the 3-D drawing												
Abstracting the figure												
Comparing the relative positions												
Comparing the relative distance												
Computing the number of cubes												
Using drawing techniques												
Counting the number of cubes												
Participants												
P ₁		4	8	4	2	5	2	3	6	3	2	3
P ₂			5	4	3	5	2	3	13	1	3	3
P ₃		4	7	4		5	2	3	3	10	2	3
P ₄		4	7	4		5	2	3	3	6	1	3
P ₅		4	7	4		5		3	3	10	2	3
Total		16	34	20	5	25	4	13	15	45	6	15

Note: Total number of spatial visualization problems asked in task-based interviews was 25. And For a problem more than one strategy could be used

There are three sub-strategies that could be accepted as intermediate strategies; partial rotation, partial manipulation and pattern-based strategies. For rotation problems one of the strategies used by the participants is partial rotation strategy, where they use partial manipulation strategy for manipulation problems. For paper folding problems they use the symmetry rule and for surface development problems they use partial folding ways of partial manipulation strategy.

For the orthographic and isometric drawing problems the used intermediate strategy is the pattern-based strategy. In orthographic drawing problems and while obtaining the 3-D object by using its front, side and top views participants use the way of abstracting the figure in to its elements such as columns and rows. Moreover, while drawing on isometric dot paper they use the way of painting their drawings to understand their drawings better.

Table 4.3 also shows the number of repetitions of each way of solving the spatial visualization problems those are asked in the three task-based interviews. When the number of repetitions is analyzed it is seen that in mental rotation problems most frequently used strategy is mental rotation. In mental rotation problems participants mostly use the ways of imagining the folding and using the symmetry rule. In orthographic drawing most frequently preferred way is abstracting the figure in to its elements and then counting the number of cubes. Lastly in isometric drawing problems participants use the way of computing the number of cubes and then using the drawing techniques and painting most frequently.

4.2.4. SAT Scores and Spatial Strategies of the Participants

When the task-based interview transcripts are analyzed, it is found out that the spatial strategies that participants use in solving the spatial visualization problems change not only with respect to the complexity of the required manipulation or complexity of the object manipulated but also with respect to the participants. In

this part of the study the participants' strategies and their SAT scores are tried to be analyzed together.

The SAT scores and responses for the task-based interview problems of P₁ shows that she has the lowest scores. In all of the SAT tests, she couldn't finish the tests in required time and she has too much unanswered questions where her incorrect responses are not more than the others. In the first task-based interview she is asked to explain her solutions for the SAT problems. For Card Rotation Test (CRT) she explains her strategy as;

P₁: I tried to rotate the figures in my mind...If we rotate once then this corner will go there.

Since she can only consider the beginning questions of the CRT she only considers the easy ones. However for the CRT problems of the second task based interview she considers more complex figures and she shift her strategy;

P₁: I controlled the positions and the distances. The black point will always be on the left.... The patterns are asymmetric than I will control their positions.

For the Cube Comparison Test (CCT) questions, she mentions that she tries to imagine the rotation;

P₁: I tried to imagine the rotation and then controlled the patterns on the faces.

Similarly in the cube comparison problems of the second task-based interview, she tries to imagine the fold and the rotation of the given figures.

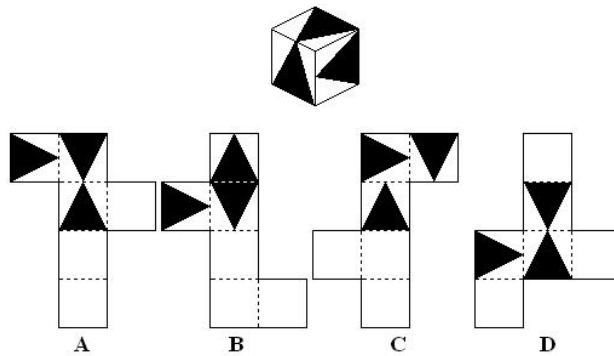

Figure 4.23. 1st Cube comparison problem of the 2nd task-based interview

For the 3-D rotation problem, she uses partial rotation strategy. She tries to imagine the rotation of the parts of the object separately.

P₁: I rotate this pit corner first, and then this pock corner should be here.

So, she has the tendency of mentally rotating the object. However, for the complex objects she tries to rotate the figure partially or control the key features of the figure.

In manipulation problems she has the tendency to use holistic strategies. For surface development test (SDT) questions for example she says; “ I tried to imagine the folding. If I fold this part outside, than these two edges will be combined. And this will be the outer surface of the object.”

In paper folding test (PFT) she tries to imagine the folding. On the other hand rather than imagining the results of punching she uses taking symmetry method.

P₁: To find the places of the holes, I took the symmetry of the given point with respect to the folded edge.

P₁: First of all, I found the place of the original point. Then by unfolding the folded paper I tried to find the folding edges. Then from the last folding I took the symmetry of the points in sequence.

Therefore, one can conclude that for interpretation type questions P₁ mostly uses holistic strategies. However, depending on the complexity of the problems or the required actions she shifts her strategy to more analytic ones.

In orthographic drawing tasks P₁ realizes that side, top and front views of the block figure is a 2-D figure made up of squares. So she counts the number of cubes on each row and column, and then she draws. That is she uses projection strategy. In the isometric drawing problems, P₁ couldn't obtain the figure mentally. She finds out that top view should be the first layer of the object, and to find the number of cubes on each row she tries to match the side and front views. In matching the numbers she uses trial and error method rather than using any other method.

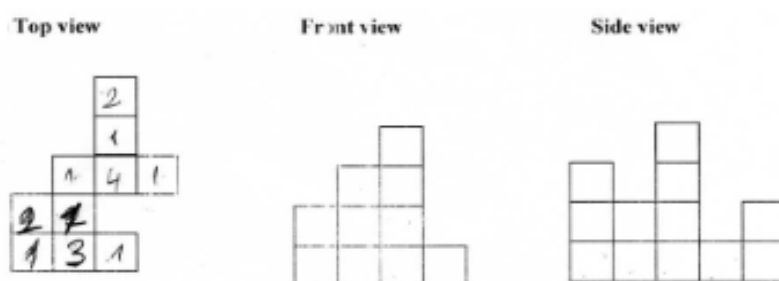

Figure 4.24. P₁ wrote the number of cubes on the top view

Drawing the block figure on the isometric dot paper is another challenge for her. She firstly determines how to draw up and back and then by using the number of cubes for each column and row she tries to use those drawing techniques. P₁ couldn't visualize how isometric drawing of the block figure would be at the end, so she only tries to use the drawing techniques for required number of cubes.

P₁: I am confused while drawing on isometric dot paper. I will go backwards like this and upwards like this but after a while I couldn't perceive the drawing. I will shade the top of the cubes and thicken the vertical edges.

As she mentions, another problem is that, she confuses with her drawings and to cope with this problem she shades the faces of her drawing and thicken the edges.

So in orthographic and isometric drawing tasks P₁ tends to use projection strategy and analytic strategies in computing the required tasks.

P₂ is the participant with the highest scores for all tests of SAT. When her responses are analyzed, it could be seen that she has no time problem in the tests and she has already managed to finish all the tests. Additionally, the number of her incorrect answers is low. When the task-based interview responses of P₂ are analyzed it could be concluded that regardless of the type and complexity of the problems she uses analytic strategies. In mental rotation tasks she doesn't try to imagine any rotation, rather she tries key feature strategy in all problems. For the card rotation problems she explains her strategy as; "... I took two asymmetric parts of the figure and fixed their positions with respect to each other and then control it in all of the others."

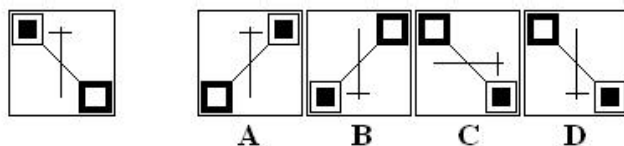

Figure 4.25. 3rd. Card rotation problem of the 2nd task based interview

In the cube comparison problems she expresses she fixes the positions of the patterns on the faces of the cubes.

P₂: In this test I fixed a pattern let say H, then I looked what was near H and controlled those two faces, if it was not enough I controlled the third face...If the pattern was symmetric, than I controlled the places, of the patterns, whether one could come to the top for example.

The cube comparison problem of the second task-interview requires folding and rotating the cubs with pattern on their faces. For those problems P₁ tells;

P₂: I control whether the patterns on the faces follow each other.

For the 3-D rotation P₁ uses key feature strategy again and makes a generalization as;

P₂: In these kinds of problems, I controlled asymmetric parts of the figures. The positions of this square tip and the hole with respect to each other should remain the same.

For mental manipulation problems P₂ uses different strategies with respect to the task characteristics. For paper folding problems, she firstly tries to understand the folding then she uses symmetry for finding the places of the holes after punching.

P₂: The holes should be symmetric with respect to the folded edges.

P₂: I take the symmetry of the holes with respect to the folding edges. If there are more than one folding, than I start from the end, and by unfolding the figure I try to take the symmetries.

So in finding the folding she uses holistic strategy but in finding the places of the holes she prefers partial manipulation strategy.

In surface development problems, on the other hand she uses key feature strategy. That is she determines the distinct edges for the given figure to be folded and that has already been folded. Then she matches those edges.

P₂: I didn't look at the whole figure. For instance this edge is long so it should match with the long edge. I always find a reference point and then I controlled with respect to it.

P₂: It is very difficult for me to imagine the folding. Thus, I think partly. I try to find reference points and I try to match the asymmetric edges.

P₂ completes also the orthographic and isometric drawing tasks truly, and she also uses mostly analytic strategies. In orthographic drawing tasks, as all other participants she counts the number of cubes and draw the top, side and front views. She uses projection strategy and mentions that;

P₂: I draw by counting the number of cubes easily.

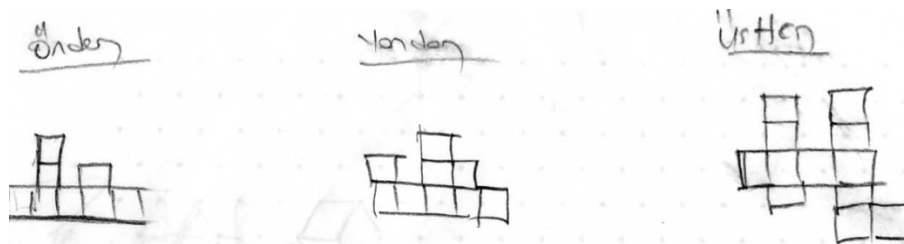

Figure 4.26. The orthographic drawing of P₂

Similarly, in isometric drawing tasks she uses projection strategy but also analytic strategies. To obtain the whole figure she finds the number of cubes on each row and column by matching the top, side and front views.

P₂: It is difficult for me to imagine the whole figure. If I say the top view the first layer, then I will obtain the rest by matching side and front views. (She matches the number of cubes and writes the numbers she found on the top view)

P₂: Now, I will obtain the first layer. Then I will match the side and front views to obtain the other layers. I will draw up with respect to the front view then I will take out the excess ones with respect to the side view.

While drawing the block figure on the isometric dot paper she uses drawing techniques to draw the required number of cubes, and she mentions the figure would be understood at the end. So she doesn't try to imagine the product.

P₂: I understand how to draw backwards and upwards, so it is not difficult for me to draw. The whole figure will come out at the end. Now I control the number of cubes.

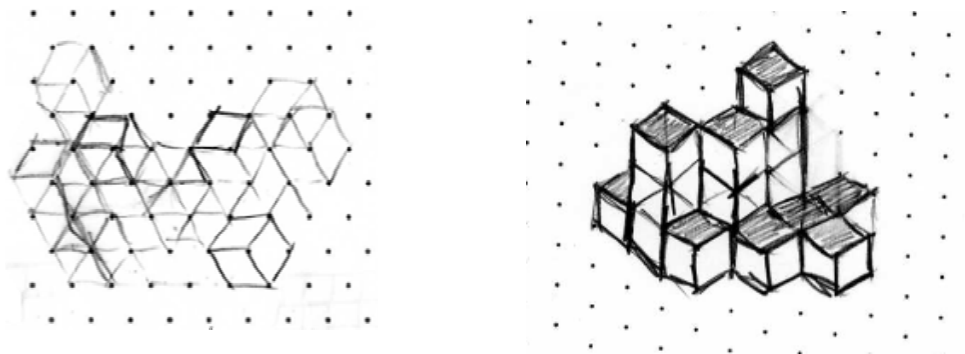

Figure 4.27. The isometric drawings of P₂ in the 1st and 3rd task-based interviews

P₃ has high scores in SAT tests. She answers most of the questions of CRT and she has only 4 incorrect responses. When her strategy in answering CRT questions, she mentions that;

P₃: All has an asymmetric part. For instance, in this problem, the thin and long part should always be on left.

Similarly, in the second task-based interview she solves the card rotation problems as;

P₃: I can't imagine the rotation of complex figures. I took distinct points, and then control their positions with respect to each other...: For example this second one is easy, so I can mentally rotate it.

P₃: In this last example I took T which is asymmetric and then I control its turns.

Therefore, P₃ tries to imagine the rotation if the rotated figure is simple, but as the figure gets complex she shifts her strategy to analytic ones. In CCT she uses partial rotation strategy and she explains her method as;

P₃: I turn this face, let say O is here, than I turn the other faces with respect to its turn. At the end I controlled the others' positions with respect to O.

However, in the second task-based interview the cube comparison problems require both folding and rotating a cube. Since, the manipulation is more complex she shifts her strategy and uses key feature strategy.

P₃: If the patterns on the faces of the cubes are asymmetric than I will control their positions. For instance, in this second problem the short part of T and the square should be on the same hand and on the left of the long part of T there should be the triangles.

For the 3-D rotation problem, she firstly mentally rotates the figure and then controls the positions of the reference corners. Therefore, she double checks her response.

P₃: I imagine the turning. This one is different from the original figure because the positions of the asymmetric corners are not the same.

P₃ had the highest score in PFT, she manages to respond all of the questions in the given time and number of her incorrect responses is low. In task-based interviews she explains her strategy as;

P₃: To understand the folding, I try to unfold the last figure. If the lower part of the folded paper is empty, than there won't be any holes. Otherwise, I take the symmetry of the points.

Therefore she tries to imagine the folding and not to confuse the sequence of the folding she starts from the last holding. After she understands the folding, she tries to find the symmetry of the holes with respect to the folded edges.

P₃: In such problems I take the symmetry of the given point with respect to the folding edge. In this problem there are two folding and I consider the folding from the last to the first.

In SDT of SAT, P₃ manages to consider all of the questions, but she has a high number of incorrect responses. She mentions that, she tries to imagine the folding, but since she couldn't manage she shifts her strategy and uses partial manipulation strategy;

P₃: I tried to imagine the folding, this part will be folded like this (showed with her hands). I tried to join the edges.

P₃: I find it difficult to imagine the folding of the whole object. So I tried to match part by part. If I fold this figure, this corner will come here and this edge will go there (she showed the folding with her hands.)

So, in mental rotation and mental manipulation problems P₃ tends to use holistic strategies. However, as the manipulation or the manipulated object gets more complex, then she shifts her strategy to partial rotation or partial manipulation. If these strategies are hard for her to apply than she uses analytic strategies.

In orthographic drawing problems she also counts the number of cubes and then drew.

P₃: I count the number of cubes and draw.

In isometric drawing tasks, she mentions she couldn't imagine the whole block figure so she tries to match the side, top and front views;

P₃: It is hard for me to imagine the whole object. I try to combine the three views. The top view is the bird's eye view of the object, so the first layer should be the same.

P₃: I will draw the first layer at the beginning. P₃: If I make up the object in my mind than I will draw it on the isometric paper. I know that top view is the first layer of the object. Then by matching the front and side views I will find the number of cubes on each column. I will write the number of cubes on the top view then I will draw the figure with respect to those numbers.

While completing the isometric drawing, she tries to obtain the mental image she has already obtained on the isometric dot paper, rather than just using the drawing

techniques. She starts drawing the first layer, but she has difficulty in perceiving her drawing;

P₃: I start drawing with the first layer. But for the upper layers, I confused the drawing. I will color the faces of the cubes, and thicken the outer edges. Some of the edges may not be seen at the end then I will erase them. To perceive my drawing better I shade its top faces..... If I start drawing from back then I will understand the unseen ones better. To understand the cubes that can be seen I paint the cubes that can be seen

P₄ has quite low SAT scores but she manages to answer more than half of the questions. For CRT she manages to answer more than half of the questions and number of her incorrect responses is low also. When she explains her strategy for CRT problems she mentions she tries to mentally rotate the figures;

P₄: I tried to imagine the rotation. For instance this is not the same; the long part changed its place.

In the card rotation problems in the second task-based interview she uses both mental rotation and key feature strategies.

P₄: I tried to imagine the rotation of these figures. And I also select different points and control their positions and distances.

In CCT questions also, she tends to use mental rotation strategy, She explains the steps of her strategy as;

P₄: First of all to understand the direction of the rotation I looked at the faces with the same pattern. For example in this one I should firstly turn

right than upwards. Then I tried to imagine how would be other faces as a result of this rotation.

In the second task-based interview, the required manipulation is more complex, and she shifts her strategy to controlling the key feature.

P₄: If the patterns on the faces are asymmetric then I controlled their positions with respect to each other.

In the 3-D rotation task, she also imagines the rotation;

P₄: I tried to rotate the object in my mind; in this last one the corners changed their positions so it is not the same.

So, in mental rotation tasks, P₄ tries to use holistic strategies. However, if she has difficulty in imagining the rotation, she uses key feature strategy. In paper folding problems P₄ also uses symmetry method to find the places of the holes after punching. And, to understand the folding, she unfolds the last folded figure.

P₄: Firstly I looked at the folding edge, and then I take the symmetry of the point with respect to that edge. To understand the folding I started from the end and tried to imagine the unfolding.

P₄: If there are more than one folding than I start from the last folding and then take symmetry.

In SDT she considers most of the figures; however she has high number of incorrect responses. When her task-based interview results are analyzed it could be

seen that she tries to imagine the folding, but as the figures becomes more complex, she tries to match the similar faces or edges.

P₄: I tried to find out which edges will come together (she repeated the folding with her hands)

P₄: I try to imagine the folding. I match the similar faces, and also I match distinct edges. I fold this face like this then the side faces should be these (she painted the faces of the figure to be folded and the faces of the object to match)

In orthographic drawing problem P₄ firstly decides the front and the side views, and then by counting the number of cubes she draws the views.

P₄: If I say here front then this face is the side, then I count the number of cubes and draw.

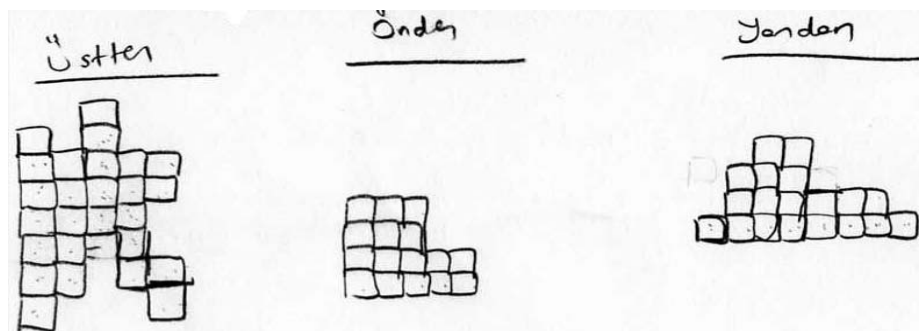

Figure 4.28. Orthographic Drawing of P₄ in the 2nd task-based interview

In isometric drawing task, P₄ tries to obtain the block figure before drawing and she mentions;

P₄: Now I will draw up the cubes on the top view.

Then she tries to match side and front views by considering the cube numbers and she obtains the figure by trial and error method;

P₄:...here there are 3 cubes but is it the same for the front view?

While drawing the block figure on isometric dot paper she says;

P₄: I will draw the first layer beforehand, than I will draw the upper layers. When I draw the upper layers some of the cubes on the back won't be seen, I will erase them. I thicken the edges and shade the top faces to avoid being unconfused.

But while drawing upwards and backwards, she confuses her drawing;

P₄: I think we draw backwards like this; I confuse it by drawing upwards.

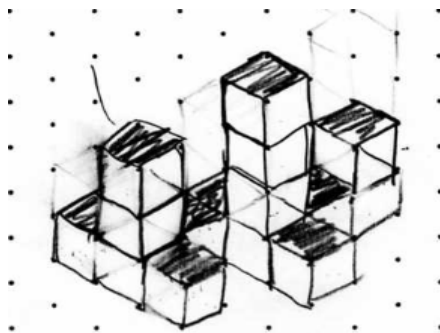

Figure 4.29. Isometric Drawing of P₄ in 2nd task-based interview

P₅ has quite low scores at SAT tests. In CRT she couldn't answer the half of the questions and the unanswered items are at the end of the test. She explains her strategy as;

P₅: I mentally do such problems. I tried to imagine the rotation, than I controlled the positions of asymmetric parts. If I think one figure is the same with the original figure than I controlled the others with that one since it is easier for me to rotate a figure that has already been rotated.

When the responses of P₅ for the card rotation problems of the second task-based interview are analyzed, it could also be seen that, she tries to use mental rotation strategy. On the other hand she also uses key feature strategy to control her responses or to consider more complex figures;

P₅: I try to imagine the rotation. I also fix the positions of the points. In this second one, the distance should remain the same; also the black one should always be on the right side.

In CCT she could only give true answers to the half of the questions and in this test she also tries to imagine the rotation. She explains the steps of her strategy as;

P₅: I looked at both of the cubes and try to find the turns by looking at the patterns, then rotate the first figure. If the pattern is symmetric like O, than I controlled the asymmetric ones such as T

In the second task-based interview, on the other hand her strategy becomes totally analytic; and she mentions "I try to fix the positions of the patterns on the faces with respect to each other."

For the 3-D rotation problem, she uses both mental rotation and key feature strategies to double check her responses.

P₅: I rotate it in my mind. Meanwhile, I controlled the asymmetric corners; their position with respect to each other should remain same.

So, one can conclude that, P₅ tends to use holistic strategies for mental rotation problems, however to check her responses meanwhile she also uses analytic strategies. Additionally, for more complex manipulations she shifts her strategy to analytic ones. P₅ has her highest scores in PFT, but her PFT scores are still lower than the other participants. She uses similar strategies with the other participants for paper folding problems. She takes the symmetry of the given holes with respect to the folded edges. Moreover, to understand the folding, she starts from the last folding and tried to imagine the unfolding.

P₅: I tried to find the symmetry of the points and I started from the last folding and come back by unfolding. I may neglect the folding where the underneath of the paper is empty.

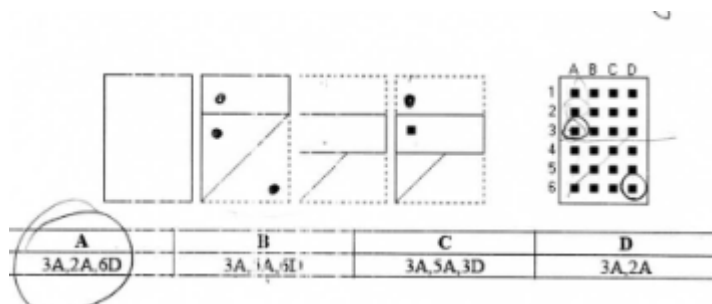

Figure 4.30. P₅ drew the folded edges and took symmetry

SDT score of P₅ is the lowest score among the other participants, she could only considered 2 figures from the totally 12 figures. She starts with the folded object and then tries to imagine the unfolding of it. She explains her strategy as;

P₅: I started from the folded object and try to find the edges around the face marked by X. I firstly matched the faces of the folded and unfolded figures marked by X, and then I try to unfold it in my mind.

So in mental manipulation problems, P₅ uses mental manipulation and partial manipulation strategies. In orthographic drawing task, P₅ counts the cubes and draws as all other participants. In isometric drawing problems; while determining the block figure, she matches top, side and front views and she explains her solution as;

P₅: I will start with the top view and for each cube there, I will match the other two views (she matches the number of cubes by trial and error method). (She wrote the number of cubes on the top view)... The bottom of the object is the top view, now here is the front and the other side is the side view. Now I will write the number of cubes on each column near the edges of front and side. Then match the number of cubes on each column.

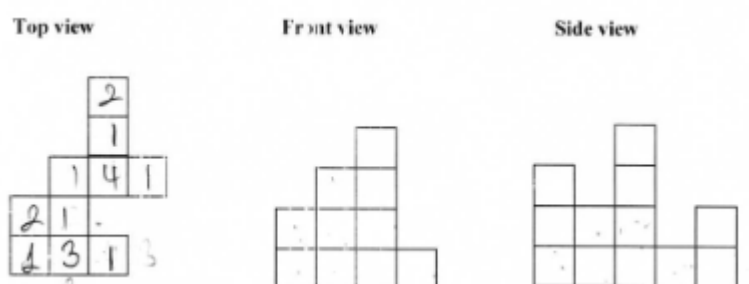

Figure 4.31. P₅ wrote the number of cubes on the top view

So she uses analytic and pattern-based strategies. While drawing the block figure on the isometric dot paper she uses drawing techniques and also paints the figure to visualize her drawing better;

P₅: Now I will draw upwards like this and backwards like this (she showed by drawing around a unit cube). Now I will start with this front column. I will paint the faces to understand my drawing.

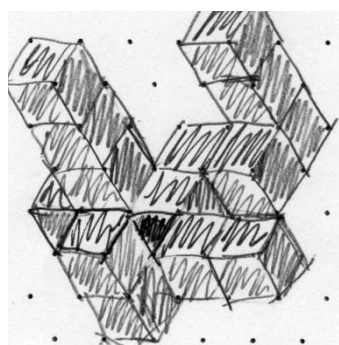

Figure 4.32. The isometric drawing of P₅ in the 3rd task-based interview

Table 4.5 summarizes the number of repetitions of the used strategies by the participants and their scores in SAT and the task-based interviews. When Table 4.5 is analyzed it is concluded that P₁ is the participants that prefer holistic strategies most frequently and she is the participant with the lowest scores on SAT tests. On the other hand P₂ is the participant who uses most frequently the analytic or intermediate strategies and she has the highest scores of SAT. This shows that high scores in SAT or task-based interviews may not mean high visualization ability. Because, there are strategies different than visualization that require less visualization but more analytic features that may help one to achieve high scores, such as in the case of P₂. So, we may conclude that rather than higher spatial ability, using the selected strategy effectively may lead higher scores in spatial ability tests. Additionally, each participant has a tendency to use holistic or analytic

strategies even if characteristics of the problems also influence selecting the strategies.

Table 4.4. The Number of Repetition of Strategies Used in the Three Task-Based Interviews and; the Scores of Participants in SAT and the Three Task-Based Interviews

	Spatial Strategies									Scores					
	Holistic			Intermediate			Analytic			SAT	Task-Based Interview				
Participants	Mental Rotation	Mental Manipulation	Total	Partial Rotation	Partial Manipulation	Pattern-Based	Total	Key Feature	Counting	Total	Rotation (CRT-CCT)	Manipulation (PFT-SDT)	Rotation	Manipulation	Drawing
P ₁	4	12	16	2	5	2	9	12	5	17	68	19	16	8	5
P ₂		9	9	3	5	2	10	20	6	26	154	53	25	20	6
P ₃	4	11	15		7		7	21	6	27	128	50	20	17	6
P ₄	4	11	15		7		7	16	5	21	111	47	21	15	6
P ₅	4	11	15		5		5	21	6	27	101	21	18	10	5

4.3. Participants' Difficulties

This section summarizes the findings of the research study on the difficulties of difficulties of adults in solving spatial visualization problems. The difficulties that the participants experience while solving the spatial visualization problems asked in the task based interviews are analyzed with respect to each kind of problems and they are intended to be categorized. To present the findings the transcriptions of task-based interviews are analyzed and the difficulties that the participants experienced while solving the problems are listed. Then the listed difficulties are categorized. The findings of the present study show that, the difficulties of the

participants can be categorized in to two main groups; inadequate proficiency and limited flexibility. In this part of the study, each of these two difficulties is analyzed with respect to all kinds of problems used in the three task-based interviews.

4.3.1. Inadequate Proficiency

The results of this study indicates that one of the main difficulties that participants experiences while solving spatial visualization problems is in using the selected strategy sufficiently which is so called inadequate proficiency. In this part of the study, the difficulties of the participants experience in using the selected strategies for each kind of problems and for all used strategies.

4.3.1.1. In Rotation Problems

In the present study the participants solve the spatial visualization problems whose required mental process is rotation by three different sub-strategies: mental rotation, partial rotation and key feature strategies. In using these strategies the participants experience the following difficulties.

Most of the participants have difficulties in using mental rotation strategy efficiently. In most cases, participants have difficulties in imagining the rotation and they mention that they need more time to answer SAT problems.



Figure 4.33. 1st Card Rotation problem of the 1st task-based interview

For instance for the card rotation problem given in Figure 4.33 P₁ mentions that;

P₁: ...in also card rotation test, if I had time, I could answer all. I should become more practical.

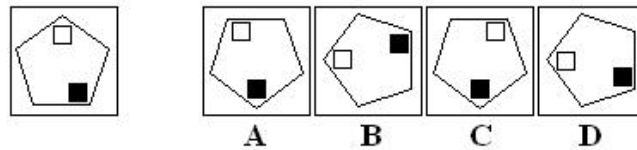

Figure 4.34. Problem 12: Card rotation problem

For the card rotation problem asked in the second task-based interview and given in Figure 4.34 P₄ explains that;

P₄: I tried to imagine the turning. The white should be vertical and black should be straight to the edges of the pentagon.

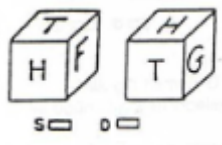

Figure 4.35. Problem1: Cube comparison problem

P₁ and P₃ paraphrase the difficulties they experience in solving the cube comparison problem given in Figure 4.35 as;

P₁: I tried to rotate to obtain the second figure and controlled the letters. But I found it so difficult, especially for the patterns such as P. I couldn't do so much.

P₃: I turned the paper if I couldn't manage to imagine the rotation.

As the rotated objects become more complex, then using key feature strategy also becomes difficult. The participants mention that, it becomes difficult to compare the parts of the object, if there are too many parts to control.

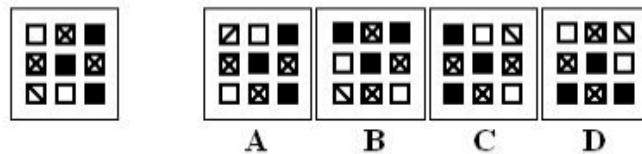

Figure 4.36. Problem11: Card rotation problem

As an example for the card rotation problem given in Figure 4.36, P₄ expresses her difficulties as;

P₄: ...There were too many parts to compare. It was hard to think all of them in the same time.

For the card rotation problem given in the second task-based interview given in Figure 4.11, P₁ has difficulty in imagining the rotation and then try comparing the relative positions of the parts of the object; however, she fails to find the right answer.

P₁: I will try to compare the relative positions of distinct parts, they should be in the same distance and same side...

As one can see in Table 4.4, partial rotation strategy is not a frequently used strategy and the participants who use this strategy don't express any difficulty while imagining the rotation of the parts of the rotated object.

4.3.1.2. In Manipulation Problems

Participants of the present study use mental manipulation, partial manipulation and key feature strategies while solving spatial visualization problems requiring manipulation as mental process.

In manipulation problems, the main difficulty is also in imagining the manipulation. In other words while using mental manipulation strategy. In paper folding test, all of the participants try to imagine the folding and they have difficulty in visualizing the folding and understanding the sequence of the folding.

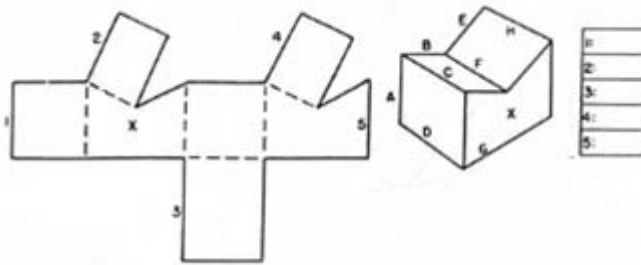

Figure 4.37. Problem 8: Surface development problem

The participants paraphrase their difficulties while solving the paper folding problem in Figure 4.37 as follows;

P₁: I should understand the folding first. (She repeated the folding with her hands.) I couldn't understand the second folding. (She tried to draw the folded edges on the figure.)

P₂: I think that the points should be symmetric with respect to the folding edges. However, I had difficulty in understanding the folding for the items in the next page.(i.e. the items with more difficult folding.)

P₂: I only had difficulty in understanding the folding of some of the paper folding problems.

P₃: I couldn't understand all of the folding. I couldn't understand how the paper became like this by folding.

P₅: I tried to unfold the folded paper in my mind. But in this question, I couldn't understand the folding. I might not understand the empty parts under the folding.

In surface development problems, the difficulty of the participants is also in understanding the folding of the 2-D figure to obtain a 3-D object. In other word is using mental manipulation strategy.

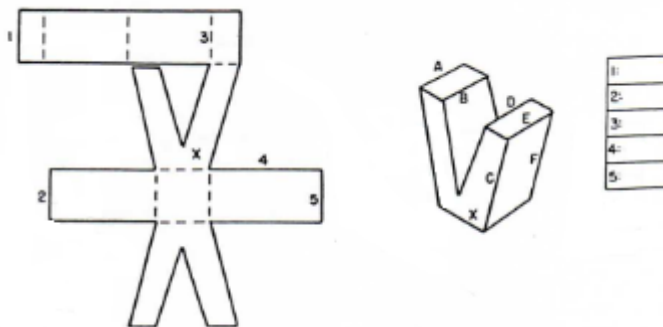

Figure 4.38. Problem 25: Surface development problem

For the paper folding problem given in Figure 4.38, participants denote the difficulties they experience as follows;

P₅: It was the most difficult one. I started from the 3-D object and I controlled which edges are around the face X. Of course, I couldn't do this in the difficult ones

P₅: ...I couldn't visualize how this went under the object when it was folded...

P₃: Surface development test was the most difficult one. I tried to visualize the folding but I confused the parts going under and back of the object.

Participants shift their strategy to partial manipulation or key feature strategies when they have difficulty in imagining the manipulation. Additionally they do not denote any difficulties in using partial manipulation or key feature strategies.

4.3.1.3. In 2-D Drawing of 3-D Objects

In the task-based interviews there are two kinds of 2-D drawing of 3-D object problems; orthographic drawing and isometric drawing problems. The results of the present study show that in solving drawing problems, participants use pattern based strategy and counting strategy. They don't use any holistic strategies. In orthographic drawing problems, the entire participants use pattern based strategy, in other words; they count the number of cubes of the given block figure and they easily draw the orthographic views. Additionally, they mention they don't have any difficulties in solving the orthographic drawing problems.

On the other hand, isometric drawing is a challenge for all of the participants of the present study. Isometric drawing task has two parts; to obtain the figure and to draw on the isometric dot view. In the first part of the problem all of the participants have difficulty in imagining the 3-D block figure by using its top, front and side views.

Top View

Front View

Side View

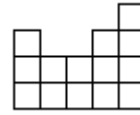
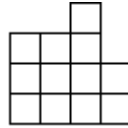
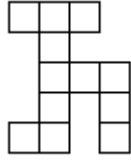

Figure 4.39. Problem 18: Isometric drawing problem

For instance, the participants explain the difficulties they experience in imagining the figure for the problem given in Figure 4.39 as follows;

P₂: I couldn't visualize the whole object...It is hard for me to visualize the whole object. This top view is the basement of the figure then I will find and write the number of upper cubes by using side and front views.

P₃: Now I should imagine the object (she thinks for a while). It is hard to imagine the whole object.

P₄: I had difficulties in constructing the 3-D object which was given with its side, top and front views. At the beginning I couldn't understand how these three views would belong to the same object.

As the participants mention they have difficulty in imagining the 3-D block figure by using its top, front and side views and in all cases they use counting strategy. They match the number of cubes by using the top, front and side views and they obtain the number of cubes on each row and column.

The second challenging part of the isometric drawing problems for the participants is drawing on isometric dot paper. In most cases they have difficulty in drawing on

the isometric dot paper and understanding their own drawings. They express the difficulties they come across while drawing on the isometric drawing as follows;

P₁: I had difficulty in drawing isometric paper, when I draw backwards, it seemed as if I drew upwards...We are going backwards like this and upwards like this but after a while, I couldn't perceive the drawing, I will shade top of the cubes and thicken the vertical edges.

P₃: It is not problem for me to draw a one layered figure but as going upwards, it is hard for me to perceive the drawing.

P₄: ... It is confusing to go upward and backwards. I think it will be helpful to shade the faces of the figure (Used trial and error method to draw)

As one can conclude from the expressions of the participants most frequent difficulty in isometric drawing problem is in understanding the drawings they complete. To cope with this difficulty they use painting way of counting strategy.

4.3.2. Limited Flexibility

When the transcriptions of the task-based interviews held by the participants are analyzed, it could be concluded that another difficulty in solving spatial visualization problems is limited flexibility. In the present study limited flexibility is defined as is the difficulty in shifting the strategy when one has difficulty in using the strategy s/he select accurately or practically.

4.3.2.1. In Rotation Problems

The analysis of the data shows that in rotation problems asked in the task-based interviews, one of the difficulties that the participants experience is imagining the rotation. As mentioned in section 4.3.1.1., for most of the rotation problems participants try to use mental rotation strategy. However, as the rotated objects get more complex they have difficulties in imagining. Therefore, they mention that they shift their strategy to partial rotation or key feature strategy.

For example, in the card rotation problem given in Figure 4.14 P₁ and P₃ explain her solution as follows;

P₁: This one seems easy; I think I can imagine the rotation...But the sides of the pentagon is the same I couldn't see. I think I should control the positions and the distances....

P₃: For the complex figures, I cannot imagine the rotation, then I try to find reference points....

On the other hand, participants mention that as the rotated figures get more complex they have difficulties even in using key feature strategy. The results of the study show that, if the participants have problems in using key feature strategy, this causes unanswered or incorrect responses. They don't try any other strategy.

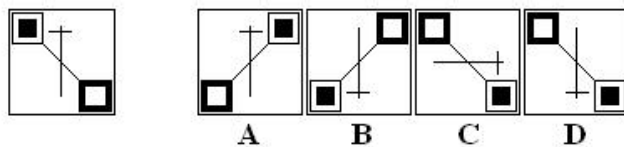

Figure 4.40. Problem 13: Card rotation problem

For instance for the card rotation problems given in Figure 4.40 P₁, P₃ and P₄ express their thoughts as follows;

P₁: This problem is a little bit complex. I may rotate the corners...How will be T, if this corner comes here? I think the answer may be this one (False)

P₃: This last one is more complex, it is harder to control but the problem is asymmetric with respect to T

P₄: This last problem is complex, it has too many parts to control, it is really difficult

In cube comparison problems, it is also difficult for the participants to imagine the rotation as mentioned before. As in the card rotation problems, most of the participants shift their strategy to key feature strategy and they try to control the positions of the patterns on the faces of the cubes. However, as the patterns get more complex they mention they have difficulty in controlling their positions and they fail to use key feature strategy. Since they don't try to use any other strategy, this causes unanswered or incorrect responses.

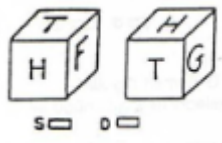

Figure 4.41. Problem 1: Cube comparison problems

As an example for the cube comparison problems given in Figure 4.41, P₁ says;

P₁: I tried to rotate to obtain the second figure and controlled the letters. But I found it so difficult, especially for the patterns such as P. I couldn't do so much.

Similarly, for the card rotation problem P₁ explains;

P₁: ...in also card rotation test I couldn't imagine the rotations quickly, if I had time, I could answer all. I should become more practical.

Therefore, the results of the present study show that in most cases participants shift their strategy to analytic ones. However, in some cases they couldn't shift their strategy and these yield false or unanswered responses.

4.3.2.2. In Manipulation Problems

In the task-based interviews and SAT there are two kinds of manipulation problems; paper folding and surface development. In solving paper folding problems, all of the participants try to imagine the folding or unfolding and even if they have difficulty in complex figures they couldn't find any other strategy. Therefore, they couldn't shift their strategy.

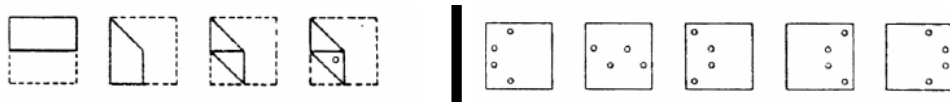

Figure 4.42. Problem 6: Paper folding problem

The participants' explanations about the paper folding problem given in Figure 4.42 is as follows;

P₂: I think that the points should be symmetric with respect to the folding edges. However, I had difficulty in understanding the folding for the items in the next page.(i.e. the items with more difficult folding.)..... I only had difficulty in understanding the folding of some of the paper folding problems

P₁: I should understand the folding first, but I couldn't understand the second folding

P₃: In this problem folding is complex, I have to think more. As the folding get complex, it is hard for me to imagine.

The other manipulation problem type is surface development problems. The analysis of the data shows that these problems are also difficult for the participants. In most of the cases participants try to visualize the folding and they don't shift their strategies.

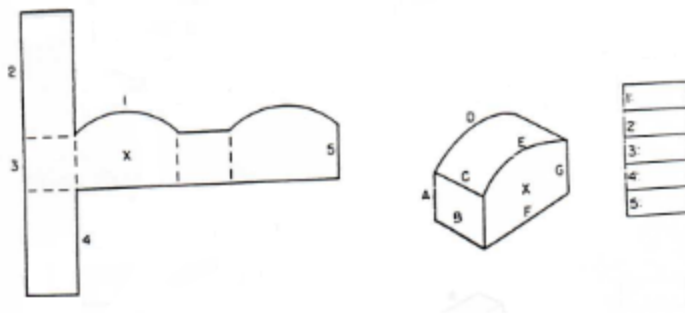

Figure 4.43. Problem 7: Surface development problem

For instance, for the surface development problem given in Figure 4.43 the participants mention;

P₃: Surface development test was the most difficult one. I tried to visualize the folding but I confused the parts going under and back of the object.

P₅: It was the most difficult one. I started from the 3-D object and I controlled which edges are around the face X. Of course, I couldn't do this in the difficult ones....I couldn't visualize how this went under the object when it was folded...

In some cases, participants shift their strategy to key feature strategy, however, they have difficulty in using the key feature strategy also. As an example for the surface development problem given in Figure 4.9 P₂, P₄ and P₅ explain their solutions as follows;

P₄: I had difficulty in Surface Development Test at most...I still had difficulties in imagining the folding. So I try to solve those problems by matching the edges one by one.

P₅: These problems are the most difficult ones. I start from the 3-D object and try to control the edges around the face marked with X. For the complex figures like this one I cannot use this strategy.

P₂: This was the most difficult part. I explored practical techniques again. I didn't look at the whole figure. For example, in this question, the long edge is here then the edge near the long edge should be here.

4.3.2.3. In 2-D Drawing of 3-D Objects

In the present study there are two kinds of problems requiring the 2-D drawing of a 3-D object; orthographic drawing and isometric drawing. As mentioned in the section 4.3.1.3, the participants don't have difficulties in completing the

orthographic drawings. On the other hand isometric drawing problems are difficult for the participants. As mentioned above, isometric drawing problems have two parts. The first part is to obtain the 3-d block figure by using the top, side and front views and the second part is to draw the obtained figure on the isometric dot paper. For the first part of the problems all of the participants mention that they couldn't imagine the 3-D block figure and they shift their strategy to counting strategy. In other words they match the top, side and front figures and they obtain the number of cubes on each row and column. Therefore, for the first part of the problem they don't have any problems in shifting the strategy.

The analysis of the data shows that the second part of the study is difficult for the participants to complete. While drawing the 3-D block figure on isometric dot paper, all of the participants use counting strategy and so they use drawing techniques. However, in most cases they have difficulty also in understanding because they couldn't imagine the 3-D block figure they couldn't visualize its isometric drawing. In this part of the problem participants try to use only different ways of counting strategy and they have difficulty in shifting their strategy to holistic ones. For example the participants explain their work while drawing on the isometric papers in the isometric drawing problems as follows;

P₁: I had difficulty in drawing isometric paper, when I draw backwards, it seemed as if I drew upwards...We are going backwards like this and upwards like this but after a while, I couldn't perceive the drawing, I will shade top of the cubes and thicken the vertical edges.

P₃: It is not problem for me to draw a one layered figure but as going upwards, it is hard for me to perceive the drawing.

P₄:... It is confusing to go upward and backwards. I think it will be helpful to shade the faces of the figure (Used trial and error method to draw)

Table 4.6 summarizes the number of cases in which the participants experienced difficulties in solving spatial visualization problems by using the participants' task-based interview transcriptions. The analysis of the Table 4.5 reveals that the main difficulties of participants are in proficiency in using the selected strategy and in flexibly selecting and using different strategies. The number of cases shows that most frequently experienced difficulty is the lack of proficiency in using holistic strategies. Additionally, for the manipulation problems main difficulty seems to be limited flexibility. In other words, most of the participants have difficulty in finding different strategies when the used strategy couldn't be used effectively.

To sum up; in mental rotation problems, the main difficulty is inadequate proficiency in using mental rotation strategy. Some of the participants shift their strategies to partial rotation or key feature strategies symmetric, even if the participants shift their strategies to key feature strategy, they have difficulty in obtaining the solutions.

In paper folding and surface development problems, all of the participants have difficulty in visualizing the folding and unfolding, in other words using mental manipulation strategy. In paper folding problems, the sequence of folding and understanding the folding are the main challenges for the participants and they couldn't find any other way to solve the problem. Similarly, in surface development problems, they mostly couldn't imagine the folding to obtain the 3-D figure. Most of the participants try to find the folding results of edges separately, by matching the similar edges in folded and unfolded figures. However, this strategy is also difficult for them to apply. Therefore low scores of participants to cope with this difficulty, however for the others this is another difficulty. That is, they couldn't manage to find another strategy. Moreover, if the compared parts or patterns are so detailed or in SDT of SAT is a result of both limitations of flexibility and inadequacy in using spatial strategies.

Table 4.5. The Number Experienced Difficulties in Solving Spatial Visualization Problems during the Task-Based Interviews

Participants	Problem Type	Difficulties in					
		Proficiency			Flexibility		
		Holistic	Intermediate	Analytic	Holistic	Intermediate	Analytic
P ₁	Rotation	3		2	2		
	Manipulation	3			2	2	
	Drawing	4	2	6			4
P ₂	Rotation						
	Manipulation	1			2		
	Drawing						
P ₃	Rotation			1			
	Manipulation	3	1		4	2	
	Drawing	3		2			4
P ₄	Rotation	2		2	2		
	Manipulation	2		2	2	2	
	Drawing	3	2	1			2
P ₅	Rotation	2		1	4		
	Manipulation	3		3	2	2	
	Drawing	3	3	2			2

All of the participants mention that they couldn't imagine the 3-D object given with its side, top and front views in isometric drawing problems. They try to find the number of cubes on each column. But, combining the three views is not such easy and most of the participants have difficulties in obtaining the number of cubes.

Drawing on isometric paper is also difficult for the participants even if they learn the drawing techniques. The main problem they experience is to perceive their own isometric drawings. Especially the cubes that should not be seen confused their minds. Moreover, the cubes that are drawn upwards and backwards seem similar. To cope with these difficulties, they all shade or paint the outer faces of the figures and thicken the outer edges. Therefore, participants' lack of shifting their strategies and lack of their aptitudes are the main difficulties of them in construction problems.

4.4. Conclusions

This study has two main purposes and one of these purposes is to investigate the spatial strategies of adults in solving spatial visualization problems. In the present study to collect data, Spatial Ability Test (SAT) and three task-based interviews are used. The SAT results and the task-based interview transcriptions of the participants are analyzed together to obtain a detailed information about participants' spatial strategies.

By using the explanations of the participants about how they respond the asked problems and results of previous research studies it is concluded that there are three main categories of spatial strategies used in solving spatial visualization problems. Moreover, by the analysis of the participants' responses, the sub strategies and different ways for using the sub strategies are defined. The strategies, sub strategies and ways of using strategies and their categorizations are given in Table 4.3.

The review of the related literature shows that there are three main spatial strategies: holistic, analytic and intermediate strategies. To solve a spatial visualization problem, if one intends to imagine the required rotation or manipulation, then this is called the holistic strategy. On the other hand, if one tries

to encode the parts of the given figure and tries to analyze the relations between these parts, then this is called the analytic strategy. Therefore, using analytic strategies require minimal visualization. There are also strategies that can be accepted between these two poles. Those strategies are called intermediate strategies. The findings of the present study confirm that adults use these three main strategies in solving given spatial visualization problems. However, more detailed descriptions are revealed.

As mentioned before, if one tends to visualize the required manipulation or rotation then it is the holistic strategy. Within this study the sub strategies of holistic strategy are defined and called as mental rotation and mental manipulation strategies. Mental rotation is used for the problems whose required mental processes are rotation and involves imagining the rotation of the given 2-D or 3-D object. On the other hand for manipulation problems participants use mental manipulation strategy. In using partial manipulation strategy, participants use two different ways. One is imagining the folding and the other one is imagining the sequence of folding. The results reveal that participants don't use any holistic strategy for orthographic and isometric drawing problems.

Analytic strategies require minimal visualization and sub strategies of analytic strategy are defined as key feature and counting strategies in this study. Key feature strategy is used both in rotation and manipulation problems. In using key feature strategy, one determines distinct parts of the given object, which is so called key features. Then, they use two different ways; either compare relative positions or compare relative distances of these parts with respect to each other. The analytic strategy used in the study for orthographic and isometric drawing problems are called counting strategy. In using counting strategy, there are three different ways. One is computing the number of cubes by matching front, top and side views of the given 3-D block figure, which is the most frequently used way in isometric drawing problems. The other one is counting the number of cubes on the given 3-D

block figure used for mostly orthographic drawing problems. While drawing on isometric dot paper, most frequent way of using counting strategy is using drawing techniques. That is to say, they draw backwards and upwards the given number of cubes just using the way to draw on isometric dot paper, rather than visualizing the whole figure.

There are also sub strategies which can be accepted as intermediate strategies. For rotation problems the used sub strategy is called partial rotation that requires rotation of the parts of the object one by one. For manipulation problems partial manipulation strategy is used in two different ways. First one is partial folding which is folding the parts of the figure one by one. The other way is using symmetry rule. For orthographic and isometric drawing problems used sub strategy is called pattern-based strategy. One way of using this strategy is abstracting the figure in to simpler elements. For instance, for 3-D block figures abstracting the figure in to its rows or columns. The other way is painting the faces or the edges of the figures to make it easy to visualize.

The analysis of SAT results with task-based interview results it is seen that in most of the cases participants are not competent in using holistic strategies. Therefore, if they try using mental manipulation or mental rotation strategies they fail to find correct answers or even if they found the correct answers it took a lot of time; and then results in low scores in SAT. Some of the participants express that they try to use both analytic and holistic strategies in the same problem to double check. This help finding correct answers however; this is also time consuming and causes unanswered problems in SAT. The analysis of the task-based interviews and SAT results show that, the participants use analytic strategies more effectively and frequently. In some cases even they start using holistic strategies; if they have difficulty in answering the problems they shift their strategies to analytic ones. Using multiple strategies in such a way, yield in higher scores in SAT and task-based interviews.

Analysis of the task-based interview shows that the problem characteristics are also important in selecting the spatial strategy. There are two types of spatial visualization problems with respect to their required actions; interpretation and construction problems. On the other hand, there are three main types of problems with respect to the required cognitive process; mental rotation, mental manipulation and 2-D drawing of a 3-D object (see Table 3.2). In SAT, there are only interpretation type questions, however in the task-based interviews the construction type questions are also asked to be completed.

For the interpretation problems, the strategies of the participants change with and within the problem, even if each participant had a tendency to use one of the holistic, analytic or intermediate strategies. Mostly, the difficulty of the test object is effective in the selection of the strategy. In mental rotation problems participants tend to use mental rotation if the rotated object is simple; in other words if the parts and the configuration between the parts of the object are not complicated. However, as the rotated object gets complex they shift their strategy to partial rotation or key feature strategies. On the other hand the ones who tend to use intermediate or analytic strategies use those strategies for all of the problems. But for some complex figures, participants couldn't manage to find the correct answer with the analytic strategies either.

In mental manipulation problems, participants are expected to imagine folding and unfolding of the given figure and a sequence of manipulations. The participants who try to use mental manipulation in the surface development problems have difficulty in solving the problems and their strategy results in too much unanswered or incorrect responses. Some of the participants shift their strategy and use partial manipulation or key feature strategies. For the paper folding test all of the participants use symmetry, which could be accepted as partial manipulation. However, they have to understand a sequence of folding. They try to mentally unfold the folded object from the last folding to the first and then take symmetry

with respect to the folded edges. So, they use mental manipulation strategy for this part of the paper folding problems.

When the construction type tasks are analyzed, it is concluded that, different than the interpretation problems not difficulty of the test objects, but the task characteristics determines the used strategy. The participants mention that it is difficult for them to imagine the product of the problems before construction. So, in these problems participants don't use any holistic strategies. In orthographic drawing problem, the top, side and front views of a given 3-D object are asked to be drawn. In the first task-based interview, the 3-D object constructed with unit cubes is given where in the second and third task-based interviews the 3-D object is given with its isometric drawing. For all of the three tasks, the participants mention that the tasks are easy. They reduce the 3-D object to 2-D views and by counting the number of cubes on each row or column and then draw on the paper, so they use pattern-based strategy.

Isometric drawing problems have two challenging parts and in each part the participants' approaches are similar. The first part of the task is to imagine the 3-D block figure given with its top, side and front views. In this part, none of the participants manage to imagine the whole object but they try to compute the number of cubes partly by combining the top, front and side views. They find out that top view is the bird's eye view of the object, so they reduce the bottom of the object to top view. Then they match the number of the cubes on each row and column by using side and front views. Thus, this part of the problem becomes a puzzle rather than a spatial visualization problem.

After computing the number of cubes on each row and column, the second part of the task begins; drawing the 3-D figure on the isometric dot paper. In this part of the problem, the participants mostly use drawing techniques to go backwards and upwards. Moreover, to perceive their drawings better they shade outer faces or

thicken the edges of the drawings. So in isometric drawing main strategies are pattern-based and analytic strategies.

Another purpose of the present study is to investigate the difficulties of adults in solving spatial visualization problems. Analysis of the task-based interview results show that the difficulties of the participants in solving spatial visualization problems can be categorized as inadequate proficiency and limited flexibility. Inadequate proficiency is defined as the difficulty in using the selected strategy efficiently. On the other hand limited flexibility is the difficulty in shifting the spatial strategy when one has difficulty in using the strategy firstly selected.

In rotation problems, for the easy objects to be rotated, most of the participants try to imagine the rotation. On the other hand participants have difficulty in imagining the rotation of the complex objects. Then, in some cases they shift their strategy and they compare the relative positions or distances of the parts of the objects rather than visualizing the rotation of the whole objects. For the items where the internal parts of the object and their relations were complex, participants have difficulty even in comparing the parts of the given object. On the other hand, some of the participants have difficulty in finding extra strategies, when they have difficulty in using the way they try to use in solving the problem. Therefore, in rotation problems the main difficulty is inadequate proficiency in using mental rotation strategy.

For the manipulation problems, most of the participants try to imagine the folding or unfolding. For the paper folding problems, the challenging part is, understanding the folding, sequence of the folding and the place of the folded edges. In paper folding problems, all of the participants try to imagine the unfolding of the paper, from the last figure to the first one and take symmetry of the given point with respect to the folded edges. They couldn't shift their strategy even if they hve difficulty, since they couldn't find another way of finding the folding. In surface

development problems, imagining the folding and unfolding the given figures are challenging for even the easy objects. Therefore, some of the participants try to shift their strategies. But, it is difficult for some of the participants to find the appropriate analytic strategy and apply it. Therefore, for manipulation problems inadequate proficiency in using mental manipulation strategy is a difficulty. Additionally, limited flexibility is also observed as a difficulty.

The problems whose required action is construction could be asked in the task-based interviews only. The participants' approaches to these problems are different than the other ones. They chose their strategies with respect to the task characteristics rather than the difficulty of the given object. Moreover, they don't shift their strategies once they have found one. Orthographic drawing task is found to be easy by all of the participants. They rarely have difficulty in imagining the top, side or front view. For the tasks, in which 3-D object is given with its isometric drawing, some of the participants have difficulty in perceiving the drawing.

Isometric drawing problems, on the other hand, are difficult to be completed for all of the participants. Isometric drawing problems have two parts. The first part requires obtaining the 3-D block figure. All of the participants have difficulty in imagining the 3-D object given with its side, top and front views and they try to find the object partly. They try to compute the number of cubes of the columns or rows of the 3-D block figure and this is a challenge for them. The participants match the given top, side and front views and while doing this, some of them just use trial and error method, or in other words no strategy. On the other hand most of them manage to find out an analytic strategy and use it for all given figures.

The second part of the isometric drawing problems is drawing the obtained object on isometric dot paper. Participants also have difficulty in drawing on isometric dot paper regardless of the complexity of the given objects. The main difficulty while drawing on an isometric dot paper is in perceiving their isometric drawings. The

cubes drawn upwards and backwards or the cubes that shouldn't been seen will be confused. The participants shade or paint the outer faces or thicken the outer edges of the figure they draw to cope with this difficulty. Therefore, for most of the participants the main difficulty in solving isometric drawing problems is inadequate proficiency in using counting and pattern-based strategies.

CHAPTER 5

DICUSSIONS, IMPLICATIONS AND RECOMMENDATIONS

The purpose of this study is to examine the spatial strategies of adults and their difficulties while they are solving spatial visualization problems. This chapter addressed discussion of the results of the study in the light of the theoretical and empirical findings of the research literature relating with the purpose of this study. Conclusion of the research findings are discussed in two sections. First section discussed the spatial strategies used by adults whereas the second section discussed the difficulties of adults in solving spatial visualization problems. Additionally, the implications of the findings of the present study and recommendations for further research are stated. This chapter ties up the research questions and literature presented in Chapter 1 and 2 with the methods and results presented in Chapter 3 and 4.

5.1. Strategies Used in Solving Spatial Visualization Problems

One of the purposes of the present study is to investigate the spatial strategies that adults use in solving spatial visualization problems. This study intends to give detailed descriptions of spatial strategies used by the participants and different ways of using the selected spatial strategies.

The present study is conducted during the spring semester of 2007-2008 academic years with five adults studying elementary or secondary mathematics education at a university in Ankara who accept participating in this study voluntarily. To obtain

related data, Spatial Ability Test (SAT) (Ekstrom, 1979) and three task-based interviews are used.

The review of related literature shows that, individuals use different strategies while solving spatial problems and a general categorization for these spatial strategies are as follows. One of these categories is *holistic strategy* that involves representing and manipulating spatial information “in a spatial way,” that is, maintaining and using information about spatial relations among elements in the mental representation (Glück & Fitting, 2003). Another group of strategies are called *analytic strategy* that involves representing and manipulating spatial information by reducing it to a systematic step by step approach that requires minimal visualization (Hsi et al., 1997). On the other hand as Glück and Fitting (2003) mentioned these two strategies are not exclusive categories, rather they could be accepted as the two end points of a continuum. So there are *intermediate strategies*. The findings of the present study confirm the previous literature in that while solving spatial visualization problems, participants use different spatial strategies. In the light of the previous studies, the spatial strategies of adults in solving spatial visualization problems are categorized in to three main groups; holistic, analytic and intermediate strategies.

According to the literature spatial visualization problems can be categorized with respect to their characteristics. One of the categorization is with respect to the required thought process to solve the spatial visualization problems. There are three different kinds of spatial visualization problems used in the present study according to their thought processes; rotation, manipulation, 2-D drawing of 3-D object problems. The problems requiring these mental processes are selected for this study, spatial visualization ability require these abilities. Another categorization of problems is according to the required action; interpretation and construction. Rotation and manipulation problems of the present study are selected as interpretation problems and 2-D drawing of 3-D objects is selected as construction

problems. The required actions are selected in a way to obtain the most efficient data.

This study intends to define the sub strategies of three main strategies and different ways of using the strategies in different kinds of problems. The sub strategies of holistic strategies are called *mental rotation* and *mental manipulation*. For the problems requiring rotation the used holistic strategy is defined as *mental rotation* strategy that requires visualizing a complete continuous or discontinuous movement, and so the product (Eme & Marquer, 1999). In the problems whose requiring mental process is manipulation, one of the strategies used by the participants is *mental manipulation* strategy which is a holistic strategy and requires visualizing the required manipulations and the result of the manipulations. The analysis of the results of the present study shows that there are two ways of using mental manipulation strategy; *imagining the folding* and *imagining the sequence*. In other words, participants imagine the required folding and imagine the sequence of the folding to solve the given manipulation problems.

Another main category of spatial strategies is *analytic strategy* and there are two sub strategies of analytic strategies; *key feature* and *counting* strategies. In the study, for the manipulation and rotation problems, one of the strategies used is key feature strategy. Key feature strategy requires verifying the identity of key features of the probes to match them with the target stimulus (Schulz, 1991). The participants of the study use two different ways of key feature strategy; *comparing the relative positions* and *comparing the relative distances*. In other words, participants choose distinct parts of a given figure that are called as the key features, then they control the positions of these parts with respect to each other or the distances between these parts. In the problems requiring 2-D drawing of 3-D objects, participants use *counting* strategy. *Counting* strategy is also an analytic strategy that involves *counting* and *computing* the number of cubes in the given 3-D block figure, and using *drawing techniques* to draw on isometric dot paper.

There are also *intermediate* strategies between holistic and analytic strategies and these strategies are *partial rotation*, *partial manipulation* and *pattern-based* strategies. For rotation problems the intermediate strategy used by the participants is *partial rotation* strategy. They encode one or more elements in the standard figure and try to visualize the results of their rotations one by one. In manipulation problems, the intermediate strategy used is called *partial manipulation* which requires encoding the parts of the standard figure and using a “symmetry rule” or imagining the manipulations of the elements of the standard figure separately. While using partial manipulation strategy participants use two different ways; *symmetry rule* and *partial folding*. In orthographic and isometric drawing problems the participants use *pattern-based* strategy which could be accepted as an intermediate strategy. This strategy involves abstracting the problem in to familiar elements and reducing the solution to cases previously solved (Hsi et.al., 1997). In the present study, this strategy is used in two different ways; *abstracting the figure* and *painting*. Abstracting the figure means abstracting the elements of the 3-D object in to simpler elements such as rows or columns Painting is a way used in isometric drawing. Participants paint their isometric drawings to visualize better.

As the findings of the previous studies on spatial strategies, present study shows that adults use different strategies in solving spatial visualization problems. The identification of the strategies shows us that there are spatial strategies that require very little visualization. That is to say, solving a spatial visualization problem or completing a spatial visualization task may not signify high spatial visualization ability. Therefore, to determine the exact level of spatial ability level of adults, it is a vital factor to know their strategies. This is important because as mentioned above, for the areas that require mental manipulation or rotation of 3-D objects such as in sketching of technical drawings, in using CAD in engineering or arts and design, analytic strategies may not work.

This study gives detailed definitions of strategies, sub-strategies and different ways of using the selected strategies. These detailed identifications help better assessment and teaching environments for spatial visualization ability. While writing the objectives of any spatial visualization ability development environment, the given definitions of the spatial strategies can be very useful. Similarly, while preparing assessment tools and extra data collecting tools such as follow up questionnaires, the detailed identification of different ways of solutions may have vital importance.

One of the important factors in the use of a strategy is accepted to be the characteristics of the spatial visualization problems (Glück & Fitting, 2003; Burin & Prieto, 2000; Eme & Marquer, 1999; Gorgorio, 1998). Addition to this as Gitimu and Workman (2007) argue, variation in use of strategies is related to task complexity or difficulty. According to them even within a single type of test, item difficulty can be important in the selection of the spatial strategies. Thus, item and test difficulty might be major determinants of strategy use in a task that measures spatial ability. Analysis of the task-based interview confirms the previous studies in a way that the types of the spatial visualization problem and their difficulty are important in using any spatial spatial strategy. In the present study, there are three types of spatial visualization problems with respect to the required mental process to perform the task; rotation problems, manipulation problems, and problems of 2-D drawing of a 3-D object. Moreover, the problems are also categorized with respect to their required actions; interpretation and construction problems. As mentioned before, rotation and manipulation problems are interpretation problems where problems of 2-D drawings of 3-D objects are construction problems.

To begin with the interpretation type of problems, in the rotation problems, the previous research studies found out that the complexity of the stimulus lead use of analytic or intermediate strategies as Glück and Fitting (2003) concluded in their research studies. Some of the participants try to imagine the rotation, where some

of them try to rotate the object part by part or the others just compare the relative positions of the parts of the given object. Moreover, some of them use more than one strategy; such as mentally rotated the object and then compared the relative positions of the parts of the object. However, as the object became more complex, participants had difficulties in imagining the rotation therefore shifted their strategy and used analytic strategies.

In the manipulation problems, the participants are expected to imagine a sequence of folding and unfolding. For all of them, imagining the folding is difficult even with the easy objects, so they tend to use partial manipulation strategy, and use the “symmetry rule”. Similarly Kyllonen, Lohman, and Snow’s (1984) pilot study participants reported shifting and adapting their strategies on a mental paper-folding task repeatedly, with strategies ranging from simple inspection of the unfolded paper on the easiest items to verbal labeling and sub vocal speech on the most difficult items. However, for some of the problems, they couldn’t find any analytic strategies and try to use holistic strategies, so they had difficulty in answering those problems.

Construction types of problems require 2-D drawings of 3-D objects, those are; orthographic drawing and isometric drawing. The participants have different approaches for the construction problems than the problems whose required action is interpretation as Gorgorio (1998) argued. First of all the difficulty of the task object is not effective in the determination of the strategy for the 2-D drawings of a 3-D object. In the isometric drawing task, the task itself is a challenge for the participants and finding a strategy is difficult for them. In the isometric drawing tasks, the participants all use *analytic* and *pattern-based* strategies. They reduce the 3-D object to a 2-D view and they compute the number of cubes of the 3-D block figure by matching its side, top and front views partially. For, the orthographic drawing tasks also, they reduce the 3-D object to its 2-D views and then by counting the number of cubes of columns or rows, they finish their drawings.

Gorgorio (1998) has already argued that when the required action is of construction, students tend to use partial approaching strategies when tasks allow manipulation such as building up an object.

Eme and Marquer (1999) conclude that different subjects use different strategies to perform the same spatial task, and as a result, have different performance levels. In the present study, the analysis of the results also shows that different participants have different tendencies in selecting the spatial strategies. Lohman and Kylönen (1983) mentioned, subjects' ability profile plays a crucial role in the choice and efficiency of the spatial strategy in the solution of the given spatial visualization problems. In other words low spatial aptitude might cause the selection of analytic or intermediate strategies, or incompetency in the use of holistic strategies. When the SAT results of the participants are analyzed with the task-based interview results it is concluded that the participants trying to use holistic strategies mostly fail to use their strategies effectively and they have low scores in SAT. For instance, the participant with the lowest score of SAT, mostly try to imagine the rotations or manipulations. When her SAT scores are analyzed in detail, it is concluded that not only she has lots of incorrect answers but also she couldn't manage to finish the tests in the required time period. Therefore, she cannot use holistic strategies efficiently. On the other hand, the participants who use analytic strategies mostly have higher scores in SAT. As an example the participant with the highest scores in SAT prefers mostly the analytic strategies while solving spatial visualization problems. She manages to answer almost all of the questions of the tests of SAT in the given time period and she has few number of incorrect answers. In other words, she uses the analytic strategies effectively. Therefore, according to the suggestions of Lohman and Kylönen (1983) we may conclude, the participants' spatial visualization ability levels are low. On the other hand Glück and Fitting (2003) argue that, although analytic representations of spatial information take less effort to encode and maintain, processing capacity limitations are not the only reason why some people use analytic instead of holistic strategies.

For the participants of this study, the tendency of the participants to use analytic strategies might be because of the fact that the participants are studying or studied mathematics in their post secondary educations and this might lead them develop and use analytical approach for any problem.

To sum up, there are different spatial strategies and selection of any of these strategies may depend on different factors. The required mental process, the required actions or the difficulty of the problems are important factors of spatial strategy selection. Moreover, the spatial ability levels of people and their tendencies are also effective factors. The selection and using of the strategies efficiently helps solving spatial visualization problems.

5.2. Difficulties in Solving Spatial Visualization Problems

Another purpose of this study is to investigate the difficulties that adults experience while solving spatial visualization problems. The conclusion of the results of this study for the following research question will be discussed in this section: What are the difficulties that adults experience while solving spatial visualization problems?

To answer the research problem given above the task-based interview and SAT results are analyzed together. The SAT and task-based interview results, the observed behaviors of participants while solving spatial visualization problems, and the expressions of the participants in the task-based interviews are used to find out the difficulties they experience while solving spatial visualization problems. The results of this study show that the difficulties of adults in solving spatial visualization problems can be categorized in to two main groups; *proficiency* and *limited flexibility*.

One of the main difficulties that participants experienced in solving the spatial visualization problems is called as *inadequate proficiency* which is defined in this

study as the difficulty in using the selected strategy truly and practically. When the difficulties of the participants are analyzed for each kind of problems, we will conclude the following results. In rotation problems, for the easy objects to be rotated, most of the participants try to imagine the rotation. On the other hand participants have difficulty in imagining the rotation of the complex objects. Then, in some cases they shift their strategy and they compare the relative positions or distances of the parts of the objects rather than visualizing the rotation of the whole objects. For the items where the internal parts of the object and their relations are complex, participants have difficulty even in comparing the parts of the given object.

In manipulation problems, most of the participants try to imagine the folding or unfolding. For the paper folding problems, the challenging part is, understanding the folding, sequence of the folding and the place of the folded edges. In paper folding problems, all of the participants try to imagine the unfolding of the paper, from the last figure to the first one and take symmetry of the given point with respect to the folded edges but they have difficulty in understanding the sequence of the folding or the result of the folding. In surface development problems, imagining the folding and unfolding the given figures are also challenging for even the easy objects.

Orthographic drawing task is found to be easy by all of the participants. They rarely have difficulty in imagining the top, side or front view. For the tasks, in which 3-D object is given with its isometric drawing, some of the participants have difficulty in perceiving the drawing.

Isometric drawing problems, on the other hand, is a difficult task to be completed for all of the participants. First of all, all of the participants have difficulty in imagining the 3-D object given with its side, top and front views and they tried to found the object partly. They try to compute the number of cubes of the columns or

rows of the 3-D block figure and this is also a challenge for them. The participants try to match the given top, side and front views and while doing this, some of them just use trial and error method, or in other words no strategy. Participants also have difficulty in drawing on isometric dot paper regardless of the complexity of the given objects. The main difficulty while drawing on an isometric dot paper is in perceiving their isometric drawings. The cubes drawn upwards and backwards or the cubes that shouldn't been seen are confused.

The other main difficulty that adults experience in solving the given spatial visualization problems is called as *limited flexibility* which is defined to be the difficulty of shifting strategies. The results of the study show that if the participants have difficulty in using the strategy they select, then they try to find another strategy and mostly they shift their strategy. However, in some cases they have difficulty in finding another strategy and this caused unanswered or false responses. In mental rotation problems, if the participants try to use *mental rotation* strategy and have difficulty in using this strategy in the solution, then they shift their strategy to *partial rotation* or *key feature* strategy. However, if they have difficulty in using *key feature* strategy, then they don't shift their strategy they have difficulty in finding extra strategies.

In manipulation problems, most of the participants try to use *mental manipulation* strategy. In paper folding problems, they all try to imagine the folding and the sequence of the folding and even they have difficulty in understanding the folding they couldn't find another strategy. In surface development problems, imagining the folding and unfolding the given figures are challenging for even the easy objects. Therefore, some of the participants tried to shift their strategies. But, it is difficult for some of the participants to find the appropriate analytic strategy and apply it.

The participants' approaches to orthographic and isometric drawing problems are different than the other ones. They choose their strategies with respect to the task characteristics rather than the difficulty of the given object. Moreover, they don't shift their strategies once they find one. On the other hand most of them manage to find out an analytic strategy and use it for all given figures. The participants shade or painted the outer faces or thicken the outer edges of the figure they draw to cope with this difficulty. The difficulties of the participants while solving spatial visualization problems are given in Table 4.6 in detail.

The results of the present study show that in most of the cases the participants are not competent in using holistic strategies. If they try using mental manipulation or mental rotation strategies then they mostly have difficulty in finding correct answers or even if they find the correct answers it take a lot of time; and this causes low scores in SAT. Some of the participants express that they try to use both analytic and holistic strategies in the same problem to double check. This helps finding correct answers however; this is also time consuming and causes unanswered problems in SAT. The analysis of the task-based interviews and SAT results shows that, the participants use analytic strategies more effectively. In some cases even they start using holistic strategies; if they have difficulty in answering the problems they shift their strategies to analytic or intermediate strategies. Using multiple strategies

In summary as Lohman (1988) pointed out, participants who did well on complex spatial tasks often changed their strategies as items became more difficult. In some sense, spatial ability may mean having an extensive and differentiated store of strategies from which to choose. Glück and Fitting (2003) expressed, individuals who were the best performers on spatial tasks were those who were able to select the best strategies for the task. Therefore being flexible in using strategies, in other words shifting strategies was important for good spatial performance. The other important thing for successful accomplishment of spatial tasks was using the

selected strategy effectively, that is having the proficiency required to use the selected strategy. If these two factors of the individual were limited, then s/he had difficulties in solving the spatial visualization problems.

5.3. Implications

In this section some implications for teachers, teacher educators, and researchers are given. The main interests of the present study are the spatial strategies of people and the difficulties they experience while solving spatial visualization problems.

The results of the study show that there are different strategies used by adults to solve spatial visualization problems and there are strategies that don't require so much visualization. So, high scores in spatial ability assessment tools may not mean high spatial ability. Therefore, while preparing assessment tools to understand the spatial ability levels of adults, this factor should be taken in to account. To cope with this problem, follow up questionnaires those are prepared to analyze the spatial strategies of people will be applied after the spatial ability tests applied. The detailed descriptions given in the present study for strategies, spatial strategies and the ways of using strategies are helpful in preparing better assessment tools and questionnaires. The participants of the present study are adults, because they are expected to define the spatial strategies they use more clearly. Additionally, they are expected to have more kinds of spatial strategies because of their backgrounds as adults and as students studying mathematics education.

The analysis of the results of the present study shows that in most of the cases participants reduced the required mental manipulation in to systematic step by step approach with minimal visualization rather than using visualization. Additionally, when the difficulties of the participants are analyzed it is seen that the failure in spatial problem solving mostly comes out with incompetency in using the selected

strategies and especially the holistic strategies. These results bring out the need of development of holistic strategies. Even the adults studying mathematics education are lack of visualization. Therefore, Turkish policy makers should give some thought to the educational poorness about spatial visualization ability of students.

Another main difficulty in solving spatial visualization problems is limited flexibility. That is to say lack of shifting the spatial strategy selected in case of failure to use it. Visualization is vital for some areas as mentioned before, on the other hand analytic or intermediate strategies may be also useful. For instance in analysis of the geometrical 2-D shapes for geometrical calculations, analytic strategies can be used instead of holistic strategies. Therefore, teaching different strategies is also useful to develop different views of visualization. Spatial ability development is one of the most important purposes of the new elementary mathematics and secondary school geometry programs. While mathematics teachers are preparing and applying spatial ability, they should be aware of that there are different spatial strategies to be developed for more competencies in spatial problems. Additionally, while assessing their students' spatial ability, they should identify the strategies used and the difficulties their students experienced in using the strategies to get feedback about their training and improve their teaching methods. Therefore, for mathematics teachers seminars should be planned about how to use spatial strategies in the assessment and development of spatial strategies. Moreover, the difficulties defined in the present study will highlight the points to be emphasized in developing students' spatial visualization abilities. The findings of the present study will be used effectively in such seminars.

Addition to the above recommendations, the curriculum developers also can use the findings of the present research study. In preparing the geometry curriculum for different levels, the objectives will be written by using the identified spatial strategies and difficulties in solving spatial visualization problems. Curriculum developers also might make authors include spatial activities that are developing

students' use of different strategies in text books. The teacher's book should be designed to guide teachers in developing and assessing spatial strategies. Additionally, while preparing spatial ability questions for national assessment tests, the questions should take in to account that there are different strategies.

Moreover, in teacher education programs mathematics teacher educators may offer courses that involve how to develop spatial ability, they should train pre-service mathematics teachers about the spatial strategies, their importance for assessment of spatial ability and the difficulties of students while using different spatial strategies. Moreover, while teacher educators are designing courses on visualization they should also be aware of the importance of spatial strategies for their students.

5.4. Recommendations for Further Research

This study mainly focuses on the spatial strategies and the difficulties of adults while solving spatial visualization problems. Based on the analysis of data, some recommendation for further research studies can be reported. First of all, this study is conducted with five adults studying mathematics education. By using their expressions, spatial abilities and difficulties in spatial visualization problem solving are tried to be defined in depth. However, this study is limited to selected five adults. Therefore, this study can be replicated with a larger group, by this way, new spatial strategies or different kinds of difficulties may be defined. Additionally, frequency of the use of spatial strategies can be analyzed and a pattern can be found.

The present study is conducted with adults who are studying mathematics education and they are somehow aware of spatial visualization and its importance. Studying mathematics or being aware of spatial ability may affect their approaches. Therefore, the study can be conducted with adults from other programs or

professions. Moreover, to understand the strategies of younger people, the study may be designed for elementary or secondary level students. Additionally, the participants of the following study are all female, so to analyze the gender factor the study will be replicated with a group consisting both male and female participants.

The study intends to give in depth definitions with examples for the spatial strategies, sub-strategies and the different ways of using these strategies for the spatial visualization factor of spatial ability. In a further research one can identify the strategies and difficulties in spatial orientation factor of spatial ability and the relation between spatial strategies used in visualization or orientation problems will be intended to be examined.

Finally, it has long been known that spatial ability could be developed by appropriate training. By, designing activities or sessions to develop spatial strategies, the effect of training on spatial strategies can be investigated. Similarly, the effect of strategy teaching for disappearing of previously determined difficulties can be researched.

5.5. Reflections about my Future Profession

As I mentioned before, as a mathematics teacher I'm aware of the importance of spatial ability and its development for my students in doing geometry and mathematics. This study reveals that there are different strategies used by adults and using multiple strategies help higher achievement in spatial tasks. I will use this finding while trying to develop my students' spatial ability also. During the spatial activities, I will attend to teach different strategies for each kind of problem, to improve their views. Moreover, in some cases, analytic strategies are not enough to cope with the visual problems, and one should visualize the required manipulations such as in technical drawing or 3-D drawings in architecture, in 3-D

atom models, etc. Therefore, by using data collecting tools, I will assess the levels of my students' spatial ability levels, bring out the related difficulties and then I will plan my courses with the help of this data.

Additionally, the main problems that the individuals experience while solving spatial visualization problems are defined as inadequate proficiency and limited flexibility. I believe that these findings of the study bring me a new perspective in geometry teaching. To cope with these difficulties I will prepare different classroom sessions. Moreover, using multiple strategies may be helpful in some cases. During my classes I will consider different strategies and the difficulties and I will make the students discuss about different strategies.

REFERENCES

Alias, M., Black, T.R. & Gray, D.E. (2001). Keupayaan memvisualisasikan ruang dan penyelesaian masalah rekabentuk struktur dalam kejuruteraan awam. (Spatial visualization ability and problem solving in structural design). *Jurnal Pendidikan Teknikal*, 1(1), 65-76.

Alias, M., Black, T. R., & Gray, D. E. (2002). Attitudes towards Sketching and Drawing and the Relationship with Spatial Visualization Ability in Engineering Students. *International Education Journal*, 3(3), . 1-12.

Baron, J. (1978). Intelligence and general strategies. In G. Underwood (Ed.), *Strategies in information processing*, pp. 403-450). London: Academic Press.

Bartmans A., & Sorby D. (1996). Making Connections: Spatial Skills and Engineering Drawings, *The Mathematics Teacher*, 89 (4), p. 394-357. In M. Alias, T. R. Black, & D. Gray E.(2002). Attitudes towards Sketching and Drawing and the Relationship with Spatial Visualization Ability in Engineering Students, *International Education Journal*, 3(3), 1-12.

Battista, M. T. (1990). Spatial Visualization and Gender Differences in High School Geometry, *Journal for Research in Mathematics Education*, 21(1), 47-60.

Battista, M. T., Wheatley, G. H., & Talsma, G. (1989). Spatial Visualization, Formal Reasoning, and Geometric Problem-Solving Strategies of Pre-service Elementary Teachers, *Focus on Learning Problems in Mathematics*, 11(4), 17-30.

Battista, M. T., & Clements, D. H. (1998). Students' Spatial Structuring of 2D Arrays of Squares, *Journal for Research in Mathematics Education*, 29(5), 503-532.

Ben-Chaim, David, Glenda Lappan, & Richard T. Houang (1985). "Visualizing rectangular solids made of small cubes: Analyzing and effecting students' performance." *Educational Studies in Mathematics*, 16. 389-409. In S. Olkun (2003) Making Connections: Improving Spatial Abilities with Engineering Drawing Activities, *International Journal of Mathematics Teaching and Learning*, (Apr,17). [Online]: <http://www.ex.ac.uk/cimt/ijmtl/ijabout.htm>.

Bennie, K., & Smit, S. (1999). "Spatial Sense": Translating Curriculum Innovation in to Classroom Practice, *Proceedings of the Fifth Annual Congress of the Association for Mathematics Education of South Africa*: 1, 22-29. Port Elizabeth: Port Elizabeth Technikon.

Bishop, A. J. (1983). *Spatial Abilities and Mathematical Thinking*, in Zweng, M. et al. (eds.) *Proceedings at the IV I.C.M.E.* (Birhauser: Boston, USA), 176-178.

Bishop, A. J. (1980). Spatial Abilities and Mathematics Education – A Review. *Educational Studies in Mathematics*, 11, 257-269. In M. T.

Battista, T. M., & Clements, D. H., (1998) Students' Spatial Structuring of 2D Arrays of Squares, *Journal for Research in Mathematics Education*, 29(5), 503-532.

Battista, M. T., Wheatley, & G. H., Talsma, G., (1982), *Journal for Research in Mathematics Education*, 13(5), 332-340.

Black, A. A. (2005). Spatial Ability and Earth Science Conceptual Understanding. *Journal of Geoscience Education*, 53(4), 402-414.

Boyraz, Ş. (2008). *The Effect of Computer Based Instruction on Seventh Grade Students' Spatial Ability, Attitudes toward Geometry, Mathematics and Technology*, Unpublished Master Thesis, Middle East Technical University, Ankara, Turkey.

Bulut, S., & Koroglu, S. (2000). Investigation of the Spatial Abilities of the Students Enrolled to 11th Grade and Mathematics Teacher Candidates. *Journal of Hacettepe University Faculty of Education*, 18, 56-61.

Burin, D., & Delgado, A. (2000). Solution Strategies and Gender Differences in Spatial Visualization Tasks. *Psicologica*, 21, 275-286.

Carter, C. C., Larussa, M. A., & Bodner, G. M. (1987). A Study of Two Measures of Spatial Ability as Predictors of Success in different Levels of General Chemistry, *Journal of Research in Science Teaching*, 24(7), 645-657.

Chu, M., & Kita, S. (2011). The Nature of Gestures' Beneficial Role in Spatial Problem Solving, *Journal of Experimental Psychology: General*, 140(1), 102-116.

Clements, M. A., Del Campo, & G. (1989). Linking Verbal Knowledge, Visual Images, and Episodes for Mathematical Learning, *Focus on Learning Problems in Mathematics*, 11(1), 25-33

Cohen, R. (1985). The development of spatial cognition. Hillsdale NJ: L. Erlbaum Associates. (From Osberg, K. M. (1997). *Spatial Cognition in the Virtual Environment*, Technical R-97-18. Seattle: HIT Lab)

Çakmak, S. (2009). *An Investigation of the Effect of Origami-Based Instruction on Elementary Students' Spatial Ability*, Unpublished Master Thesis, Middle East Technical University, Ankara, Turkey.

Dean, A. L. (1976). The Structure of Imagery, *Child Development*, 47, 949-958

Delialioğlu, Ö. (1996). *Contribution of students' logical thinking ability, mathematical skills and spatial ability on achievement in secondary school physics*, Unpublished Master Thesis, Middle East Technical University, Ankara, Turkey.

Delialioğlu, Ö., & Aşkar, P. (1999). Contribution of Students' Mathematical Skills and Spatial Ability in Secondary School Physics, *Journal of Hacettepe University Education Faculty*, 16-17, 34-39.

Ekstrom, R. B., et al. (1976). *Kit of Factor-Referenced Cognitive Tests*. ETS, Princeton, NJ.

Ekstrom, R. B., French, J. W., & Harman, H. H. (1979). Cognitive factors: Their identification and replication. *Multivariate Behavioral Research Monographs*, 79(2).

Eme, P. E., & Marquer, J., (1999). Individual Strategies in a Spatial Task and How They Relate to Aptitudes, *European Journal of Psychology of Education*, 14(1), 89-108.

Fennema, E., & Sherman, J. (1997). Sex-Related Differences in Mathematics Achievement, Spatial Visualization and Affective Factors. *American Educational Research Journal*, 14, 51-71.

Gardner, H. (1985). *Frames of Mind: Theory of Multiple Intelligencies*. In M.M. Hatfield, N.T. Edwards, G.G. Bitter. *Mathematics Methods for Elementary and Middle School Teachers*, Needham Heights, MA Allyn and Bacon (1989)

Geddes, D. & Fortunato, I. (1993). *Geometry: Research and Classroom Activities* (From D. T. Owens, Ed., *Research Ideas for the Classroom: Middle Grades Mathematics*. New York: Macmillan, 66 1993. In New Jersey Mathematics Curriculum Framework — Standard 7 — Geometry and Spatial Sense, 209-249

Gitimu P., & Workman, J., (2007). Influence of Strategy Choice on Spatial Performance in Apparel Design, *Clothing&Textiles Research Journal*, 25(2), 171-183.

Glück, J., & Fitting, S., (2003). Spatial Strategy Selection: Interesting Incremental Information. *International Journal of Testing*, 3(3), 293-308.

Goldin, G. (2000). *A Scientific Perspective on Structures, Task-Based Interviews in Mathematics Education Research*. Handbook of Research Design in Mathematics and Science Education (p. 517–545). New Jersey: Lawrence Erlbaum.

Gorgorio, N., (1998), Exploring the Functionality of Visual and Non-Visual Strategies in Solving Rotation problems, *Educational Studies in Mathematics*, 35 (3), 207-231.

Gray, D. E. (2002). Attitudes Towards Sketching and Drawing and the Relationship with Spatial Visualization Ability in Engineering Students, *International Education Journal*, 3(3), 1-12.

Guay, R. B. (1976). *Purdue Spatial Visualization Test*. West Lafayette, Indiana, Purdue Research Foundation.

Hershkowitz, R. (1989). Visualization in Geometry- Two Sides of the Coin, *Focus on Learning Problems in Mathematics*, 11(1), 61-76.

Hershkowitz, R., Parzysz, B., & Dormolen J. V. (1996). Space and Shape, *International Handbook of Mathematics Education*, 161-204.

Hsi, S., Linn, M.C. & Bell, J.E. (1997). The Role of Spatial Reasoning in Engineering and the Design of Spatial Instruction. *Journal of Engineering Education*, 151-158.

Hodgson, T. (1996). Students' Ability to Visualize Set Expressions: An Initial Investigation. *Educational Studies in Mathematics*, 30, 159- 178.

Just, M. A., & Carpenter, P. A. (1985). Cognitive Coordinate Systems: Accounts of Mental Rotation and Individual Differences in Spatial Ability. *Psychological Review*, 92, 137-172.

Kayhan, E. B. (2005). *Investigation of high school students' spatial ability*. Unpublished master's thesis, Middle East Technical University, Ankara, Turkey.

Kimura, D. (2000). Sex and cognition. Cambridge: MIT Press.

Kolb, B., & Whishaw, I. Q. (1981). Neonatal frontal lesions in the rat: Sparing of learned but not species-typical behavior in the presence of reduced brain weight and cortical thickness. *Journal of Comparative and Physiological Psychology*, 95(6), 863-879.

Kosslyn, S. M. (1980). *Image and Mind*. London: Harvard University Press.

Linn, M. C., & Petersen, A. C. (1985). "Emergence and Characterization of Gender Differences in Spatial Abilities: A Meta-Analysis, *Child Development*, 56, 1479-1498.

Lohman, D.F. (1979). *Spatial ability: A Review and Reanalysis of the Correlational Literature* (Tech. Rep. No. 8). Stanford, CA: Aptitude

Research Project, School of Education, Stanford University. In Diezmann, C. M., Watters, J.J.(2000). Identifying and Supporting Spatial Intelligence in Young Children, *Contemporary Issues in Early Childhood*, 1(3), 45-60

Merriam; S. B. (1998). *Qualitative Research and Case study Applicationsin Education* (Rev. Ed.). San Fransisco: Jossey-Bass Publishers.

McGee, M.G. (1979) Human Spatial Abilities: Psychometric Studies and Environmental, Genetic, Hormonal, and Neurological Influences. *Psychological Bulletin*, 86(5), 889-918.

Milakofsky, L., & Patterson, H.O., (1979). The reliability and validity of an instrument to assess Piaget's tasks. *Journal of Chemical Education*, 56, 87-90. In Osberg, K. M. (1997). *Spatial Cognition in the Virtual Environment*, Technical R-97-18. Seattle: HIT Lab

Milli Eğitim Bakanlığı, (2005). *Talim Terbiye Kurulu Başkanlığı, İlköğretim Matematik Dersi Öğretim Programı ve Kılavuzu 6-8. Sınıflar*. Milli Eğitim Basımevi-Ankara.

Milli Eğitim Bakanlığı, (2006). *Talim Terbiye Kurulu Başkanlığı, İlköğretim Matematik Dersi Öğretim Programı ve Kılavuzu 6-8. Sınıflar*. Milli Eğitim Basımevi-Ankara.

Milli Eğitim Bakanlığı, (2009). *Talim Terbiye Kurulu Başkanlığı, Ortaöğretim Geometri Dersi Öğretim Programı ve Kılavuzu 9-10. Sınıflar*. Milli Eğitim Basımevi-Ankara.

Milli Eğitim Bakanlığı, (2010). *Talim Terbiye Kurulu Başkanlığı, Ortaöğretim Geometri Dersi Öğretim Programı ve Kılavuzu 11. Sınıflar*. Milli Eğitim Basımevi-Ankara.

Milli Eğitim Bakanlığı, (2011). *Talim Terbiye Kurulu Başkanlığı, Ortaöğretim Geometri Dersi Öğretim Programı ve Kılavuzu 12. Sınıflar*. Milli Eğitim Basımevi-Ankara.

Mohler, J. L., (2008). A Review of Spatial Ability Research, *Engineering Design Graphics Journal* ,72(3), 19-30.

National Council of Teachers of Mathematics (1989). *Curriculum and Evaluation Standards for School Mathematics*. Reston, Va.: The Council.

National Council of Teachers of Mathematics (2001). *Navigating through Geometry in Grades 9-12*. Reston Va.:20191-9988.

National Council of Teachers of Mathematics (2003). *Curriculum and Evaluation Standards for School Mathematics*. Reston, Va.: The Council.

Olkun, S. (2003) Making Connections: Improving Spatial Abilities with Engineering Drawing Activities, *International Journal of Mathematics Teaching and Learning*, (Apr,17). [Online]: <http://www.ex.ac.uk/cimt/ijmtl/ijabout.htm>.

Orion, N., Ben-Chaim, D., & Kali, Y., (1997). Relationship Between Earth-Science Education and Spatial Visualization, *Journal of Geoscience Education*, 41, 129-132.

Osberg, K. M. (1997). *Spatial Cognition in the Virtual Environment*, Technical R-97-18. Seattle: HIT Lab.

Owens, K. D., & Clements, M.A. (1998). Representations in Spatial Problem Solving in the Classroom, *Journal of Mathematical Behavior*, 17 (2), 197-218.

Pallascio, R., Allaire, R., & Mongeau, P. (1993). The Development of Spatial Competencies through Alternating Analytic and Synthetic Activities, *For the Learning of Mathematics*, 13(3), 175-190.

Pallrand, G., & Seber, F. (1984). Spatial Abilities and Achievement in Introductory Physics, *Journal of Research in Science Teaching*, 21, 507-516.

Piaget, J. (1952). *The Origins of Intelligence in Children*. New York: International Universities Press. In K. M. Osberg (1997). *Spatial Cognition in the Virtual Environment*, Technical R-97-18. Seattle: HIT Lab.

Potari, D., & Spilotopolulou, V. (1992). Children's Representations of the Development of Solids, *For the Learning of Mathematics*, 12(1), 27- 32.

Presmeg, N. (1997). Research on Visualization in Learning and Teaching Mathematics.

Pribyl, J.R., & Bodner, G.M. (1987) Spatial Ability and Its Role in Organic Chemistry: a Study of Four Organic Courses, *Journal of Research in Science Teaching*, 24, 229–240.

Robihaux, R. R. (2002). Predictors of Spatial Visualization: Structural Equations Modeling Test of Background Variables, *Journal of Integrative Psychology*, 2.

Robihaux, R. R. (2003). The Improvement of Spatial Visualization: A Case Study, *Journal of Integrative Psychology*, 4, 10-41.

Saczynski, J S, Willis, S L & Schaie, K W (2002). Strategy Use in Reasoning Training With Older Adults. *Aging Neuropsychology and Cognition*, 9 (1), 48-60.

Samuels, M., & Samuels, N. (1975). *Seeing With the Mind's Eye*. New York: Random House. In Osberg, K. M. (1997). *Spatial Cognition in the Virtual Environment, Technical R-97-18*. Seattle: HIT Lab.

Stake, R. E. (2000). *Case studies*. In N. K. Denzin & Y. S. Lincoln (Eds.), *Handbook of qualitative research* (2nd ed., pp. 435-454). Thousand Oaks, CA: Sage.

Sorby, S.A. (1999) Computer aided design instruction. *1999 ASEE Annual Conference Proceedings Session 1438*. [Online] In M. Alias, T. R. Black, & D. E.Gray, (2002). Attitudes Towards Sketching and Drawing and the Relationship with Spatial Visualization Ability in Engineering Students, *International Education Journal*, 3(3), 1-12.

Sorby, S. A. (1999). Developing 3-D Spatial Visualization Skills, *engineering Design Graphics Journal*, 63(2), 21-32.

Tai, D. W. S., Yu, C. H., Lai, L. C., & Lin, S. J. (2003). *World Transactions on Engineering and Technology Education UICEE*, 2(2), 251-268.

Tartre, L. A. (1990). Spatial Orientation Skill and Mathematical Problem Solving, *Journal for Research in Mathematics Education*, 21(3), 216- 229.

Thurstone, L. L.,(1938; 1969). *Primary Mental Abilities*, Chicago:University of Chicago Press. Reiss, K. (1999). Spatial ability and declarative knowledge in a geometry problem solving context. In O.Zaslavsky (Ed.). *Proceedings of the 23rd International Conference for the Psychology of Mathematics Education*, 1, 303). Haifa (Israel): Technion.

Usiskin Z. (1987) Resolving the Continuing Dilemmas in School Geometry. In R. Hershkowitz, *Visualization in Geometry: Two Sides of the Coin, Focus in Learning Problems in Mathematics*, 11(1), 61- 76.

Van Niekerk, R. (1995) From Spatial Orientation to Spatial Insight: A Geometry Curriculum for the Primary School. *Pythagoras*, 36, 7-12. In Bennie, K., & Smit, S. (1999). "Spatial Sense": *Translating Curriculum Innovation in to Classroom Practice, Proceedings of the Fifth Annual Congress of the Association for Mathematics Education of South Africa*: 1, 22-29. Port Elizabeth: Port Elizabeth Technikon.

Vandenberg, S. G. & Kuse, A. R.(1978). Mental Rotations: A Group Test of Three-Dimensional Spatial Visualization. *Perceptual and Motor Skills*, 47, 599-604.

Velez, M. C. (2005). *Visualization Diversity: A Cognitive-Based Training Method for Visualization Comprehension*, Unpublished Doctorate Thesis Dissertation, Rutgers, the State University of New Jersey.

Wiley, S. (1990). An Hierarchy of Visual Learning. *Engineering Design Graphics Journal*, 54(3), 30-35. In K. M. Osberg (1997). *Spatial Cognition in the Virtual Environment, Technical R-97-18*. Seattle: HIT Lab.

Witkin, H.A., & Goodenough, D.R. (1977). Field dependence and interpersonal behavior. *Psychological Bulletin*, 84, 661-689. In Osberg, K. M. (1997). *Spatial Cognition in the Virtual Environment Technical R-97-18*. Seattle: HIT Lab.

Yakimanskaya, I. S. (1991). *The Development of Spatial Thinking in School Children* (N.T.C.M.: Reston, USA). In Gutierrez, A. (1989) *Visualization in 3-Dimensional Geometry: In Search of a Framework..*

Yin, R. K. (1994). *Case Study Research; Design and Methods*, Sage Publications, California, 1994.

Yue, J. (2006). Spatial Visualization by Isometric Drawing. *Proceedings of the 2006 IJME-INTERTECH Conference* Session IT 302-031

Zimler, J., & Keenan, J. M., (1983). Imagery in the Congenitally Blind: How Visual are Visual Images? *Journal of Experimental Psychology: Learning, Memory and Cognition*, 9(2), 269-282

APPENDIX A

SAMPLE QUESTIONS OF SPATIAL ABILITY TEST (SAT)

Paper Folding Test (PFT):

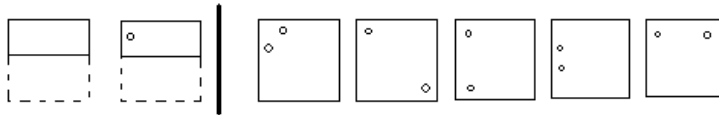

The square shaped paper on the left side of the vertical line is folded and then a hole is punched. After unfolding the paper, which one of the shapes in the right side of the vertical line will appear?

Surface Development Test (SDT):

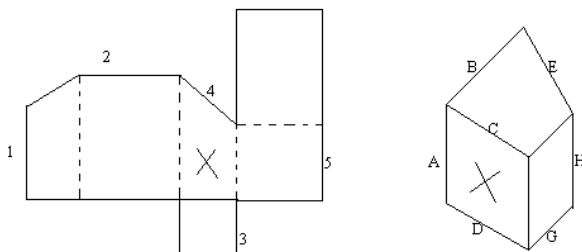

When the paper is folded from the dotted lines, the subject on the right will be formed. By imagining the folding of the paper, match the numbered edges to the letters.

p.c. the surface marked by X on unfolded paper on the left and on the subject on the right shows the same surfaces.

Cube Comparison Test (CCT):

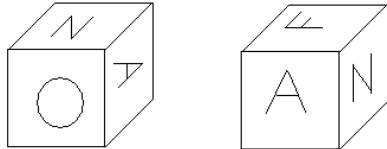

In the following cubes all the numbers, figures and letters appears only once on each cube, but it can be in an unseen position. Then, find out whether the cubes on the left and the right are the same. If the cubes are the same then mark S (Same), otherwise mark D (Different).

Card Rotation Test (CRT):

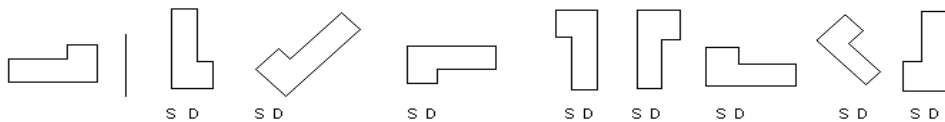

This test requires comparing the shape on the left side of the vertical line with the eight shapes on the right side of the vertical line. Find out whether the shapes on the right side can be determined by rotating the shape on the left side of the vertical line, in other words examine whether the shapes are the same or different. If the shapes are the same as the shape on the left side of the vertical line then mark S (Same), otherwise mark D (Different).

APPENDIX B

TASK-BASED INTERVIEWS

1st TASK-BASED INTERVIEW QUESTIONS

Task1: Explain your solution for the following questions of the Cube Comparison Test.

1)

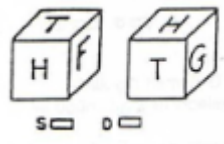

2)

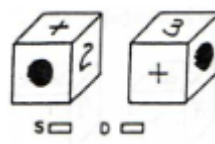

Task2: Explain your solution for the following questions of the Cart Rotation Test.

3)



4)



Task3: Explain your solution for the following questions of the Paper Folding Test.



Task4: Explain your solution for the following questions of the SDT.

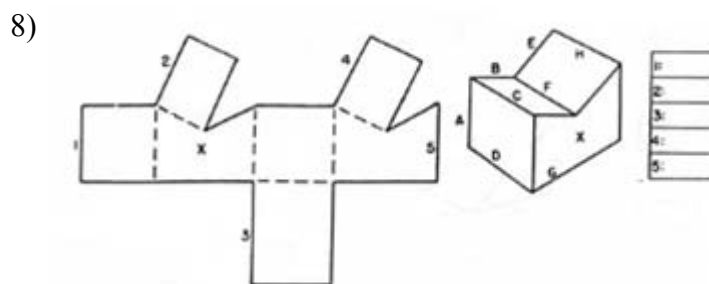
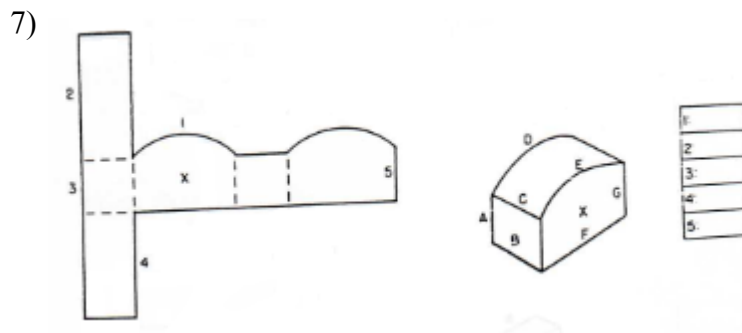

Task5: 9) Construct a 3-D object using the given unit cubes and then draw the top view, front view and the side view of the 3D object

Task7: In the following figure, the top view, the side view and the front view of the same 3-D object is given; please obtain the 3-D object and draw this object to the isometric paper.

10) TOP VIEW

FRONT VIEW

SIDE VIEW

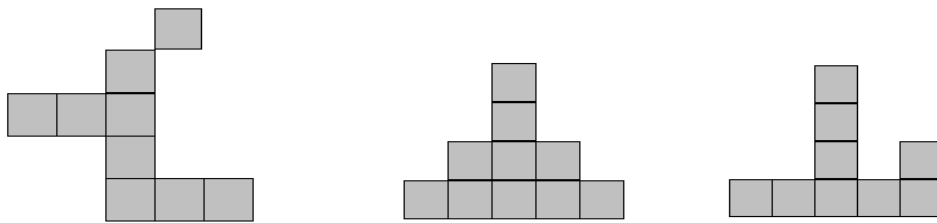

2nd TASK-BASED INTERVIEW QUESTIONS

Task1: In the figures shown in below, one of the shapes is identical to the first figure but has been rotated. Which figure is identical to the first?

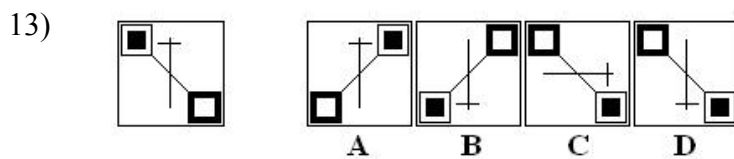
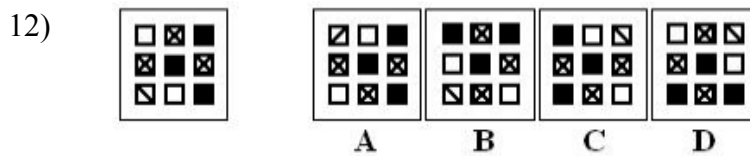
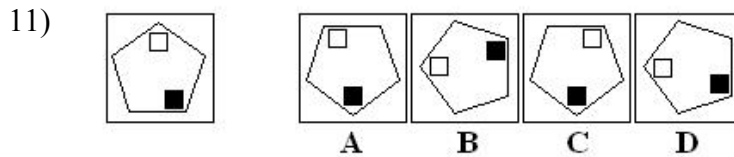

Task2: Which pattern can be folded to make the cube shown?

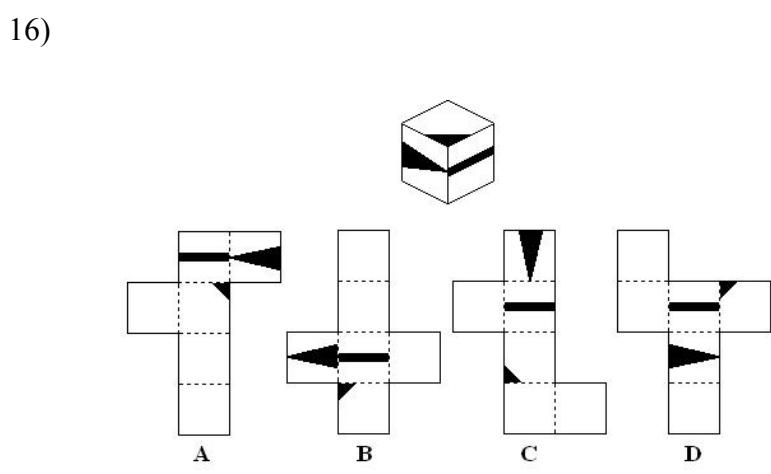
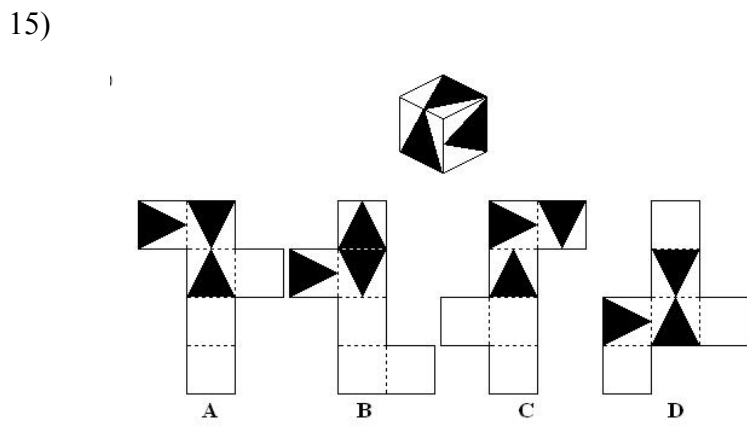
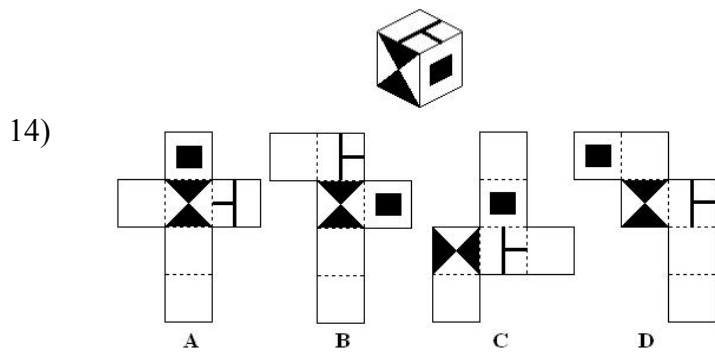

Task3: Draw the top view, front view and side view of the given object.

17)



Task4: Draw the 3-D object given with its top view, front view and side view on the isometric paper?

18) Top View

Front View

Side View

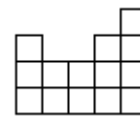
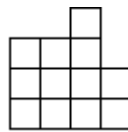
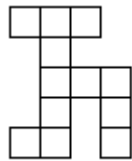

3rd TASK-BASED INTERVIEW QUESTIONS

Task1: In the objects shown in below, one of the shapes is not identical to the first object but has been rotated. Which object is different from the first?

19)

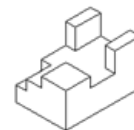
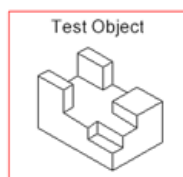

Task2: The drawings show a sheet of paper which has been folded. The black square indicates where a hole was punched. Where do holes appear when the sheet is unfolded?

20)

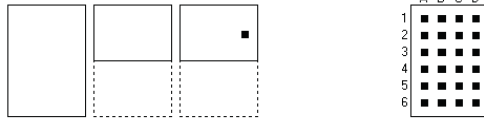

A	B	C	D
2C,5C	2D,5D	3D,3D	2C,2D

21)

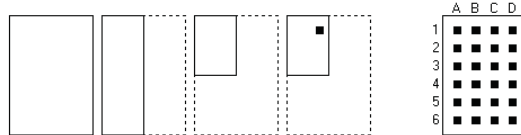

A	B	C	D
1B,1C,5B,5C	2B,2C,5B,5C	1B,2C,6B,6C	1B,1C,6B,6C

22)

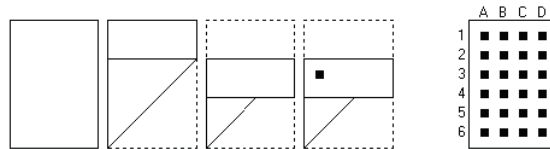

A	B	C	D
3A,2A,6D	3A,5A,6D	3A,5A,3D	3A,2A

Task3: Draw the top view, front view and the side view of the following 3D object

23)

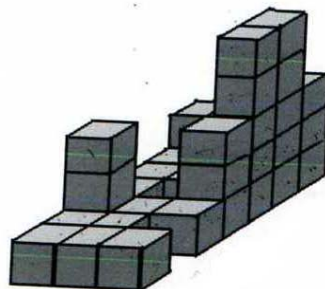

Task4: Draw the 3-D object given with its top view, front view and side view on the isometric paper?

24) Top view

Front view

Side view

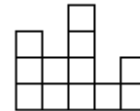
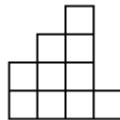
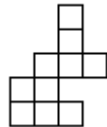

Task5: Explain your solution to the following question of the Surface Development Test.

25)

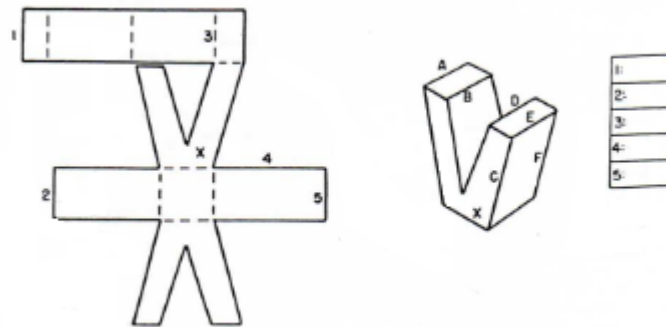

APPENDIX C

CODES OF THE TASK-BASED INTERVIEWS

A) Spatial Strategies

1. Holistic Strategies

1.1. Mental Rotation Strategy

1.1.1. Imagining the rotation

1.2. Mental Manipulation Strategy

1.2.1. Imagining the folding and unfolding of the figure

1.2.2. Imagining the sequence of manipulations

2. Intermediate Strategies

2.1. Partial Rotation Strategy

2.1.1. Rotating the parts of the figure separately

2.2. Partial Manipulation Strategy

2.2.1. Taking symmetry

2.2.2. Partial folding

2.3. Pattern-Based Strategy

2.3.1. Reducing the problem

2.3.2. Painting/shading the faces of the isometric drawing

3. *Analytic Strategies*

3.1. Key Feature Strategy

3.1.1. Comparing the positions of the patterns

3.1.2. Comparing the relative distance of the parts of a figure

3.2. Counting Strategy

3.2.1. Counting the number of cubes of the 3-D block figure

3.2.2. Using drawing techniques to draw upwards and backwards

3.2.3. Computing the number of cubes

B) Difficulties

1. Inadequate Proficiency

1.1. In Mental Rotation Problems

1.1.1. While using key feature strategy

1.1.2. While using partial rotation strategy

1.1.3. While using mental rotation strategies

1.2. In Mental Manipulation Problems

1.2.1. While using key feature strategy

1.2.2. While using partial manipulation strategy

1.2.3. While using key feature strategy

1.3. In 2-D Drawing of a 3-D Object

1.3.1. While using pattern-based strategy

1.3.2. While using analytic strategy

2. Limited Flexibility

APPENDIX D

SAT RESULTS OF THE PARTICIPANTS

Table D₁: SAT Results of P₁

Test	Part	True	False	Empty	Total
Card Rotation	I	30	6	44	58
	II	28	5	47	
Cube Comparison	I	6	3	12	10
	II	4	3	14	
Paper Folding	I	4	3	3	9
	II	5	2	3	
Surface Development	I	5	5	20	9
	II	4	5	21	

Table D₂ :SAT Results of P₂

	Part	True	False	Empty	Total
Card Rotation	I	65	7	8	123
	II	58	1	21	
Cube Comparison	I	18	3	0	31
	II	13	5	3	
Paper Folding	I	7	2	1	15
	II	8	1	1	
Surface Development	I	20	7	3	38
	II	18	9	3	

Table D₃: SAT Results of P₃

Test	Part	True	False	Empty	Total
Card Rotation	I	47	1	32	108
	II	61	3	16	
Cube Comparison	I	10	2	9	20
	II	10	3	8	
Paper Folding	I	8	2	0	17
	II	9	1	0	
Surface Development	I	11	11	8	33
	II	12	8	10	

Table D₄: SAT Results of P₄

Test	Part	True	False	Empty	Total
Card Rotation	I	54	2	24	99
	II	55	5	20	
Cube Comparison	I	5	4	12	12
	II	7	6	8	
Paper Folding	I	6	1	3	14
	II	8	1	1	
Surface Development	I	19	3	8	33
	II	14	9	7	

Table D₅: SAT Results of P₅

Test	Part	True	False	Empty	Total
Card Rotation	I	34	3	43	77
	II	43	5	36	
Cube Comparison	I	13	8	0	24
	II	11	7	3	
Paper Folding	I	5	4	1	12
	II	7	2	1	
Surface Development	I	3	1	27	9
	II	6	0	30	

APPENDIX E

TRANSCRIPTIONS OF THE INTERVIEWS

1st Task-Based Interview of P1

1-2) P₁: Çevirdim hayal ettim. İkinci şekli elde etmek için kafamda çevirdim ve üzerlerindeki harfleri kontrol ettim. Ama çok zorlandım. Testte ters P gibi sorularda çok zorlandım pek yapamadım.

3-4) P₁: Simetriği farklı oluyor. Kafamda çevirmeye çalıştım. Ama çok zaman alıyor.

5-6) P₁: Katlama şekillerini anlamakta zorlandım.

B: Deliklerin sayısına nasıl karar verdin?

P₁: Mesela burada 4e katlanmış, 4 delik vardır dedim. Doğru mu bilmiyorum tabi de. Noktaların tam yerlerini bulmak için de katlama yerlerine göre simetrilerini aldım.

7-8) P₁: Bunları yapamadım, çok zordu. Kafamda katlamaya çalıştım ama bakarak yapamadım. Elimde yapsam belki daha kolay olurdu.

9) P₁: Şekle bakarak çizmek kolay. Ama üstten görünüm için üstten bakmam lazım. (ayağa kalkıyor). (Küpleri sayarak çiziyor)

10) P₁: İzometrik kağıda çizmeyi bilmiyorum. (Önce biraz çizme alıştırmaları yapıyor)

P₁: Aslında daha önceden böyle çizimler yapmıştım. Ama öncelikle cismi oluşturmam gerek. Bu küplerin yeri doğru mu?

(Verilen görünüşleri birbirine karıştırıyor ve hata yapıyor)

(Görünüşleri nasıl bir araya getireceğini bulamıyor)

P₁:Önden görünüşe göre yapınca böyle oldu. Ama yandan bunu nasıl sağlatacağımız anlamadım.

P₁: Daha önce geometri dersinde öğrenmişim ama soruyu anlamamışım. Bu üç görüntüyü birleştirmem gerekiyor. Uzun zamanda yapabilirim belki ama şu anda toparlayamıyorum.

2nd Task-Based Interview of P₁

11) P₁: Şekiller birbirine çok benziyor zor olacak ayırt etmem. Dönmeyi kafamda hayal etmeye çalışıyorum. Bir kez döndürürsek şu köşe buraya gelir. Ama böyle düşünmek zor oldu. Belirgin noktaların birbirine göre konumlarına bakalım, aynı uzaklıkta ve aynı tarafta olmaları gerekiyor. Ama burada algılayamadım, hepsi birbirine benziyor.

12) P₁:Bu kolay bunların dönüşünü hayal edebilirim sanırım. Ama beşgenin kenarları aynı göremedim böyle. Uzaklık ve konumlarından kontrol edebilirim. Siyah hep sağda kalacak 2 birim uzaklıkta. O zaman 2.si.(D)

13) P₁: Şu son soru da bu şekilde baksam karışık biraz. Köşeleri döndürsem, bu köşe buraya geldiğinde T nasıl olur? Cevap bu sanırım.(Y)

14-15-16) P₁: Kapalı haliyle kontrol edeceğiz.

B: Evet

P₁: Hayalimde katlamaya çalışıyorum. Şu kenarlar bir araya gelir.

Zaten 2 ve 3te şekiller asimetric o yüzden onları birbirlerine göre kontrol edebiliriz. Şekilleri kontrol ediyorum

Ama 1de bu yöntem zor, dönme olabilir. A ile D arasında kaldım ama sanırım A?

B: Neden onda karar verdin?

P₁:Bilmem sadece tahmin.

17) B: Şimdi de bu şeklin üstten, önden ve yandan görünüşlerini çizeceğiz.

P₁: Tamam burası ön olsun burası da yan olsun.

Şu arası boşluk mu acaba?

Arkasını da göremiyorum, burada küp var kabul edeceğim.

18) B: üstten, önden ve yandan görünümü verilmiş olan cisim izometrik kağıda çizmen gerekiyor.

P₁: İzometrik kağıda çizmekte çok zorlanıyorum, arkaya giderken yukarı gidiyor gibi görünüyor, karışıyor. Ama öncelikli olarak şekli kafamda oluşturmam gerek. Bunda da zorlanıyorum.

P₁: Öncelikle şekli boş bir kağıda çizeyim ben. Şimdi yandan ve önden dört katlı olandan başlıyım. Sonra onun yanında şu var.(deneme yanılma yöntemiyle oluşturuyor şekli ve çiziyor)

P₁: Şimdi sayarak bir daha kontrol etmem gerek.

B: Şimdi de izometrik kağıda çizelim.

P₁: Önce biraz çalışayım çizmeye.

B: Birim küp çizerek başla isteren.

P₁:Evet, böyle çiziyorduk sanırım, arkaya gitmek için, şuraya çiziyorduk. Sanırım karıştırmamak için tepelerini boyasam daha iyi olacak. Bu görünüşler aynı olmayacak sanırım.

B: Evet, farklı açılardan görünüş oldukları için aynı olmaz.

P₁: Hımm... Benim baya uzun sürüyor ama boyayınca anlamaya başladım şekli.

P₁: Tamam oldu sanırım.

3rd Task-Based Interview of P₁

19) B: Aşağıdakilerden hangisi verilen objeden farklıdır?

P₁: (Soruyu anlamaya çalışıyor) Hımmm... nasıl yaparız?

B: Neye göre kontrol edersin?

P₁: Şu boşluğa göre (girintiyi gösteriyor).

Şimdi şöyle çevirirsem (elleriyle havada çevirme hareketi yapıyor) şu boşluk buraya geliyor. Çıkıntı da buraya gelmeli. Bu 3. Olmuyor. (doğru)

20) B: Kağıt katlama testini yapıyoruz ama cevaplar için tabloyu kullanıyoruz.

P₁: Bunu yapmış

B: Hayır bunlar şıklar.

P₁:Tamam. Burasının 2mi 3 mü olduğunu nereden bileceğiz?

B: Hizalarına bakacağız.

P₁: Tamam bu 2-D, 6 taneyse bu 2'ise katlama noktasına göre simetrisini alırsak 5-D olur

21) P₁: İlk noktanın yerini belirleyeyim önce. Buradan katlamayı açarak devam ederim. (Katlamanın sırasını karıştırıyor) İlk katlama yerine göre sonra da ikinciye göre simetrisini alalım.

22) P₁: Önce katlamayı anlamam gerek. (Elleriyle boşlukta katlamayı tekrar ediyor) İkinci katlamayı anlamadım. (Şeklin üzerinde katlamaların açılımlarını çizmeye çalışıyor. İlk noktanın tablodaki yerini buluyor.

P₁: Şimdi burayı böyle katlamış, açınca burası olmaz mı? Aaaa katlama noktalarının arasından olacak şimdi anladım. (Doğru)

23) B: Bu cismin de üstten, önden ve yandan görünümünü çiziceksiniz.

P₁: Üstten başlıyorum. Burasını boşluk bırakıyorum. (Sayarak çiziyor)

(Sıraları karıştırıyor, hangisi yanda hangisi üstte zor görüyor)

P₁: Burada bir sıra var, ama arkada 3'lü sıra var. Şekli tamamen şimdi anladım, şimdi çiziyorum.

B: Şimdi önden ve yandan.

P₁: Önü burası olarak alıyorum. Şimdi burası arkasında olduğuna göre, burası 3 katlı oluyor. Yok 2 mi oluyor? 2 oluyor. (Katlarda hata yapıyor)

P₁: Şurası da yan olsun o da şöyle... (Doğru)

24) B: Şimdi de burada üstten, önden ve yandan görünümü verilmiş olan cisimi izometrik kağıda çiziceksin.

P₁: Nereden başlasam acaba? Birim küp çizerek başlıyorum. İlk katı çiziceğim önce.

Üste nasıl gidiyorduk? Arkasına gitmeye çalışıyorum ama üste çıkıyor. (Üstten görünümüne bakarak ilk sırayı yerleştiriyor)

P₁: Şimdi de ön yüze bakacağım. Ön yüz ne tarafta acaba? (kaçar sıra olduklarını sayarak ön yüzü buluyor)

P₁: Küp sayıları eşleşmedi. Tüm cisimi görmek çok zor. Önden ikinci, yandan üçüncüde dört sıra var, o zaman burası dört katlı. (üstten görünüm üzerinde hangi küp kaç katlı karar veriyor)

P₁: Cismi anladım şimdi izometrik kağıda çizmem gerek ama çizerken karıştırıyorum.

Geriye şöyle, yukarıya da böyle gidiyorduk (çizerek gösteriyor) ama belli bir süre sonra şekli algılayamıyorum. Üst yüzeylerini karalıyım, kenarları da koyulaştırınca daha rahat anlaşılıyor.

25) B: Son olarak şu soruyu çözer misin?

P₁: Kafamda katlamaya çalışıyorum. Başka bir yolu var mı bilemiyorum tabi ama. (eliyle katlamayı tekrar ediyor). Bu parçayı dışarıya katlarsam, bunu da içeriye, bu iki kenar bir araya gelir. Ama kenarların birisi aşağıda karşı karşıya nasıl gelir? O zaman 1-D, dış yüzeyi kapladığı için de 5-C, B-2ve 4 de burada.

1st Task-Based Interview of P₂

1-2) P₂: Bu testte şöyle yaptım; örneğin H nin yanında ne var, küpü çevirirsem aynı kalır mı? İki yüzü karşılaştırdım, eğer aynılarsa üçüncüyü kontrol ettim.

3-4) P₂: Eğer yüzeydeki harf O gibi simetrikse o zaman yerlerini kontrol ettim. O üste gelebilir mi?

P₂: Şekillerdeki iki asimetric yeri alıp birbirlerine göre konumlarını sabitledim. Ve bütün hepsinde bunu kontrol ettim.

5-6) P₂: Bu soruyu yapamamış bile olabilirim. Noktalar katlanan kenarlara göre simetric olmalı sanırım. Ama özellikle arka sayfadaki sorularda katlamayı anlamakta zorlandım.

7-8) P₂: Bu en zor bölümdü. Ben de yine kendime pratik yöntemler buldum. Tüm şekle bakmadım. Mesela bu soruda uzun kenar burası, uzun kenarın yanında bu olacak.

P₂: Bütün şekli gözümde canlandıramadım. Bir de süre sorunu vardı tabii.

P₂: Her zaman bir referans noktası bulup ona göre kontrol ettim.

9) P₂: bu benim için kolay. Öncelikle bir cisim oluşturayım. Burayı ön burayı da yan olarak kabul ediyorum. Ama diğer tarafını görmem için döndürmem gerek. (sayarak çiziyor)

10) P₂: İzometrik kağıtta çizdiklerim biraz değişik duruyor bunu çizemeyebilirim.

B: Cismi çizmeden önce bu küplerle oluştur istersen.

P₂: Tamam. Öncelikle ilk sırayı oluşturacağım, üstten görünümü kullanarak.

P₂: Daha sonra da yandan ve önden görünümleri eşleştirerek üzerindeki katları bulurum. Üstten başlıyorum. Örneğin, burada 3 küp var bu sıranın tamamına üçer küp koyuyorum, ön yüze göre hepsini yerleştirdikten sonra yan yüzden kontrol ederek fazlalıkları çıkaracağım. (cismi oluşturuyor)

B: Şimdi de izometrik kağıda çiz.

P₂: Arkaya ve yukarıya nasıl gideceğimi anladım. O yüzden çizmem zor olmayacak. Çizimim bittiğinde şekil anlaşılır zaten.

P₂: Bitti, şimdi de küplerin sayılarını kontrol ediyorum. Tamam.

2nd Task-Based Interview of P₂

11) P₂: sadece döndürme var yansıma yok değil mi?

B: Evet

P₂: Algılayamadım ben birden. (Ellerini kullanıyor ve belirleyici noktalar arıyor.) Referans noktaları alıyorum. Biraz karışık ama birden fazla referans noktasını kontrol etmem gerek. Cevap C.

12) P₂ :Burada da zaten 2 nokta var. Onların birbirlerine göre konumlarını sabit tutarsak B olur.

13) P₂ :Bu son soruda zorlandım. Bir referans noktası aldım ama ayırt edemedim başka bir tane daha bulmam lazım. Tamam, ikisini kontrol edersek, D.

14) P₂: Birden fazla cevabı var mı?

B: Hayır

P₂: Şekillerin birbirini takip etmesine bakıyorum ama açılınca takip etmeye de bilir. (Bir referans köşe alıyor ve şekillerin takip edip etmediğine bakıyor) Mesela şu olabilir. Başka yerlere gidebilir mi diye bir daha düşünüyorum. (Ellerini kullanmıyor sadece referans noktalarını takip ediyor.) Cevap A.

15) P₂: Burada da aynı teknik ama bu daha kolay. Cevap B.

16) P₂: Bu da aynı şekilde A olur.

P₂: Kendim bir teknik buldum ve onu uyguluyorum.

17) B: Şimdi de bu şeklin üstten, önden ve yandan görünüşlerini çizeceğiz.

P₂: Bunları çizmek daha kolay. Sayarak rahatça çizebiliyorum.

18) B: üstten, önden ve yandan görünümü verilmiş olan cisim izometrik kağıda çizmen gerekiyor.

P₂: Şekli kafamda canlandırmam zor oluyor. Üstten görünümüne ilk sıra dersem, üstlerini eşleştirerek bulabilirim.

P₂: Üstten, yandan ve önden görünüşlerdeki küp sayılarını birlikte kontrol edeceğim. (Küpleri sayarak sayılarını yazıyor)

P₂: Şimdi tekrar kontrol edeyim, aa ama sağlamıyor. Tekrar kontrol ediyorum. (Bir stratejisi yok tekrar tekrar kontrol ederek şekli elde ediyor.)

B: Şimdi izometrik kağıda çizelim.

P₂: Ben bunda zorlanıyorum. İzometrik kağıt benim direkt gördüğümü değil başka bir açı veriyor, o yüzden zorlanıyorum.

B: Önce birim küp çizerek başla istersen.

P₂: Evet, ben bu kenardan başlıyorum. (Başladığı köşenin katlarını çizdikten sonra yan tarafa geçiyor.) (Geriye ve yukarı doğru çizerken zorlanmıyor) (D)

3rd Task-Based Interview of P₂

19) P₂: Sanırım birinciyi döndürerek diğerlerini elde etmeye çalışacağız.

B: Evet, aynı olmayı bulmanı istiyorum.

P₂: Tamam. Ben bu tarz sorularda simetrik olmayan şekillere bakıyorum. Şuradaki girinti ve kare şeklindeki çıkıntının birbirlerine göre konumu hep aynı kalmalı. Bu bunun hep sağında kalacak. Evet bu ilk şekilde soluna gelmiş diğerleri aynı bu farklı.

20) P₂: (soruyu okuyor.) Burada kağıt katlama yapıyoruz, ama bu yandaki noktalı şekli anlamadım.

B: Cevaplarını belirtmek için bu tabloyu kullanacaksın.

P₂: Ha, sanırım anladım, bu noktalardan hangisi diye bakıyoruz.

P₂: Katlama sorularında ben katlama yerine göre simetri alıyorum. Şimdi burada nerden katladığımı bulmam gerek. Ama bu noktalı yerde düşünmek zor. Bu noktaların ortasından da katlayabilir mi?

B: Evet, bu konuda bir kısıtlama yok.

P₂: Tamam. O zaman, tam ortası şurası oluyor. (çiziyor katlama yerini) Buraya göre simetri alıyorum.

21) P₂: Bunu da rahat yapabilirim, ama katlama karışıkça düşünmekte zorlanıyorum. Bunu iki kez katlamış. Şimdi katlamayı açarım sırasıyla. İlk önce şöyle açalım (Açtığı yeri çiziyor) Noktanın simetrisi burada. (Eliyle açma hareketi yapıyor)

P₂: Şimdi bunu bir de böyle açıyorum(eliyle açıyormuş gibi yapıyor), noktaların buraya göre bir daha simetrisini alıyorum. Ama bu noktalar bu tabloda hangilerine rastlar acaba?

B: Birbirlerine göre uzaklıklarını göz önünde bulunduracaksın.

P₂: Bunu net söyleyemiyorum ama sanırım bu noktalar.

22) P₂: İşte katlama karışıklaşmaya başladı. Şimdi bu katlama nasıl oluyor bi düşünmem lazım.

P₂: Anladım sanırım. Tamamen katlamamış kenarda boşluk kalmış. Hah anladım şu yukarıyı da aşağı katlamış (eliyle tekrarlıyor) Buradan delersek, önce şurayı çizeyim. Katlama çizgisi burada olmalı (Tablo üzerine çiziyor.) Simetrisi burada olur. Şimdi de burayı açalım. Şimdi bir tane mi iki tanemi nokta oluşur? (düşünüyor)

P₂: Bir tane olur. O da burada olmalı.

23) B: Bu cismin de üstten, önden ve yandan görünümünü çizeceksiniz.

P₂: Bunlarda pek zorlanmıyorum. Şurası bir sıra altta sanırım. Üstten başlıyorum (sayarak çiziyor)

P₂: Burası ön olsun, burası da yan. (sayarak çiziyor)

24) B: Son olarak, üstten, önden ve yandan görünümü verilmiş olan cismin izometrik kağıda çizmen gerekiyor.

P₂: Bunlarda hala zorlanıyorum. Şekli kafamda canlandırmak zor oluyor benim için. Şimdi ben önce izometrik kağıda alt sırayı çizeyim, üstten görünümüne bakarak sonra üstleri bulurum. (İzometrik kağıda çiziyor, zorlanmadan)

B: Tamam

P₂: Şimdi üstleri bulmam gerek. Yan ve önden görünümünü eşleştirmem lazım. Şu dört katlı olanı yerleştireyim önce, önden ve yandan üçüncü sırada o zaman şurası 4 katlı. Sanırım çizmeden önce hepsini bulsam iyi olur, çizerken arkada bulunanlar görünmeyebiliyor. (bulduklarını üstten görünümün üzerine sayı olarak yazıyor)

B: tamam şimdi çizmeye başla istersen.

P₂: İşte zor kısmı bu. Şimdi arkadan başlıyorum. Buradan görünmeyenleri silerek devam edebilirim. (Doğru çiziyor)

25) B: Bana bu soruyu anlatarak yapar mısın?

P₂: En zorlandığım soru tarzı hala bu. Katlanmış halini tamamen hayal etmem çok zor. Ben de parça parça düşünüyorum. Kendime referans noktaları buluyorum. Asimetrik olan kenarları eşleştirerek yapmaya çalışıyorum.

1st Task-Based Interview of P₃

1-2) P₃: Bunu çeviriyorum, örneğin O burada, sonra da diğerlerini ona göre çeviriyorum, En sonunda da O'nun sağında mı solunda mı yerlerini kontrol ediyorum. (kağıdı çeviriyor) Gözümde canlandıramayınca kağıdı çeviriyorum.

3-4) P₃: Bu sorularda çok zorlanmadım. Her birinin asimetrik bir yeri vardı. Örneğin bu soruda ince uzun parça her zaman solda olacak. Buna göre kontrol ettim.

5-6) P₃: Katlama şekillerinin hepsini anlamadım.

P₃: Katlandıktan sonra nasıl bu hale gelmiş anlayamadım. Soruyu çözebilmek için katlamayı tersten kontrol ettim. Eğer altı boşsa delik olamaz buna baktım. Ve katlama yerlerine göre noktaların simetrisini aldım.

7-8) P₃: En çok bunlarda zorlandım. Bu testin hepsi benim için zordu. Bunları biraraya getirmeye çalışıyorum. (eliyle katlama hareketini yapıyor) Burası alta gidiyor, bu da üste. Bazı kenarlar biraraya geliyor.

P₃: Gözümün önüne getirmeye çalıştım ama göremedim çoğunu. Belki de elimle hiç yapmadığım içindir.

9) P₃: İstedğim şekli yapabilir miyim?

B: Evet.

P₃: (şekli oluşturuyor) O açıdan bakmadan çizemiyorum pek. Önden çizmek için şekli çevirmem gerek. (sayarak çiziyor)

10) B: İzometrik kağıda çizim yapmayı biliyor musun?

P₃: Biraz zor ama yapabilirim.

B: tamam.

P₃: Önce şekli hayal etmem gerek. (bir süre düşünüyor.) Şeklin tamamını düşünmek çok zor.

P₃: Görünüşleri birleştirmeye çalışıyorum.(bir süre daha düşünüyor). Tamam, üstten görünüm cismin kuşbakışı görünüşü, o zaman en altı onun gibi olmalı. İlk katı üstten görünümüne göre oluşturuyorum. Daha sonra önden ve yandan görünümleri eşleştirerek üstlerde kaçar küp olduğunu bulurum.

P₃: Örneğin bu ilki önden ve yandan üç katlı o zaman burada üç kat var. (küpleri sayarak ve eşleştirerek yerleştiriyor.)

B: Tamam şimdi de izometrik kağıda çizeceksin.

P₃: Burada biraz zorlanıyorum ama deneyeceğim.

B: İstersen biraz çizim çalışması yap.

P₃: Tamam, ben ilk sırayla başlıyorum. Tek katlı bir cismi çizmek çok sorun değil ama üste çıkınca şekli algılamakta zorlanıyorum. Burası iki katlı o zaman arkasındaki tek katlı yer görünmeli. Ben şekli boyayabilir miyim yoksa karıştıracağım. Şu dış kenarları da koyulaştırsam daha iyi görünecek.

2nd Task-Based Interview of P₃

11) P₃: İlki gibi karışık şekilleri kafamda çevirerek göremem bunlarda kendime belirgin noktalar alıyorum, bunların birbirlerine göre konumlarını kontrol ediyorum. Örneğin sağda hep iki boş solda bir boş kutu kalacak.

12) P₃: örneğin bu ikinci kolay. Bu soruda kafamda çevirmeye çalışıyorum,

13) P₃: Sonuncusu biraz daha karışık, kontrol etmek de zor gibi ama bu T ye göre asimetrik şekil bundan yararlanıyorum.

14) P₃: Burada küpleri kapatmak zor değil aslında kapatınca şekillerin birbirlerine göre durumlarını yaklaşık olarak tahmin ediyorum ama şekil döndürülünce aynı mı olur bunu düşünmem çok zor. Bu ilkinde üzerlerindeki üçgenler aynı o yüzden emin olamıyorum, ama diğerlerindeki şekiller asimetrik o yüzden onların birbirlerine göre durumlarını kontrol etmem kolay.

15) P₃: Mesela bu ikinci soruda Tnin kısa kenarı küpe bakacak uzun kenarının solunda da üçgenler olacak bunu 2 sağlıyor.

16) P₃: 3.de üçgenin ucundan çizginin başlaması lazım bunu bir tek A sağlıyor zaten.

17) B: Şimdi de bu şeklin üstten, önden ve yandan görünüşlerini çizeceğiz.

P₃: Ben bunları sayarak yapıyorum. Üstten başlayarak çiziyorum. Burası ön burası da yan olsun. (sayarak çiziyorum) (D)

18) B: üstten, önden ve yandan görünümü verilmiş olan cisim izometrik kağıda çizmen gerekiyor.

P₃: Önce cisim gözümde canlandırmam gerek. Üstten görünüm üzerinde kaç kat olduğunu bulmam lazım önce. Şeklin tamamını birden düşünemiyorum. Tamam burası 2 katmış, burası 1 olur...(Üstten görünümün üzerine yazıyor)

B: Şimdi izometrik kağıda çizmen gerekiyor.

P₃: Tamam deneyeceğim. Önce tabanı çizeyim. Bütün ayrıtları çizmemem gerekiyor sanırım ama sonradan silebilirim. Bitti alt şimdi önden görünüme bakıyorum. Bu iki katlıymış çiziyim. Arkalarda görünmeyecek olanları sonradan silebilirim. (Arkada kalan parçayı algılamakta zorlanıyor ama çiziyor) Şeklin daha iyi algılanması için üstlerini şöyle karalıyorum.

3rd Task-Based Interview of P₃

19) P₃: Bir tanesi farklı diğerleri aynı mı?

B: Evet

P₃: Şimdi kafamda çeviriyorum. Bunlar aynı bu ilki farklı, burada asimetrik olan bu iki köşenin birbirlerine göre durumları farklı.

20) P₃: (soruyu okuyor.) Kağıt katlama testine benziyor ama cevaplar neden böyle?

B: Cevaplarımı belirtmek için bu tabloyu kullanacaksın.

P₃: Anladım, noktaların yerini bu tabloda göstereceğim.

B: Evet

P₃: Ben bu sorularda katlama yerine göre simetri alıyorum. Burada tam ortadan katlamış, tam karşı tarafında olacak diğer delik.

B: Peki tabloda hangisi?

P₃: Bu 2A da olduğuna göre diğeri de aşağıdan 1 yukarıda olacak 5A da.

21) P₃: Bu ikinci soruda iki katlama var, katlamaları sondan başa doğru düşünüyorum ben. Önce bu son katlama, sonra ilk. İkisi de tam ortadan o yüzden kolay.

22) P₃: Bu soruda katlama karışık, daha iyi düşünmem lazım. Katlamalar karmaşıklaştıkça anlamam zorlaşıyor. Sondan başa doğru gelmem lazım. (eliyle tekrar ediyor)

23) B: Bu cismin de üstten, önden ve yandan görünümünü çizeceksiniz.

P₃: Burası ön burası da yan olsun. Sayarak çiziyorum bunlar kolay.

24) B: Burada da üstten, önden ve yandan görünümü verilmiş olan cisim izometrik kağıda çizmen gerekiyor.

P₃: Bunları daha rahat çizebiliyorum. Önce şekli kafamda oluşturursam çizmem daha kolay oluyor. Bu üstten görünüş en alt sıra olacak diğerlerini eşleştirerek önce her birinin kaçar sıra yukarı çıkacağını buluyorum. Bu sayıları üstten görünümün üzerine yazıyorum.

B: Tamam

P₃: Burası ön burası da yan. Eşleştirirsek burası 4 kat olan yer, burası 2. (üstten görünümün üzerine sayıları yazıyor)

B: tamam şimdi çizmeye başla istersen.

P₃: Arkadan başlayıp öne doğru gelirim görünmeyenleri daha rahat algıları. Bu köşeden başlıyorum. Arkada kalanların ve görünenlerin daha anlaşılır olması için görünenleri şu kalemle boyuyorum. Üstleri de şu siyahla karalayayım. (çiziyor)(D)

25) P₃: Bu sorular en çok zorlandığım soru tarzı. Tümünün katlanmasını hayal etmekte çok zorlanıyorum, o yüzden parça parça eşleştirmeye çalışıyorum. Bu açık şekli kapatmaya çalışırsam şu kenar şöyle geliyor(eliyle tekrar ediyor). Burası alta gidecek, aslında belirgin uzun ya da kısa olan şu kenarları eşleştirmekle başlarsam daha mantıklı.

1st Task-Based Interview of P₄

1-2) P₄ : Aynı şekilli olan yüzlere baktım, ve döndürmenin nasıl olduğunu bulmaya çalıştım. Örneğin burada önce sağa sonra da yukarıya doğru çevirmem gerek. Sonra da bu döndürmenin sonucunda diğerleri nasıl olur onu hayal etmeye çalıştım. Ama üzerinde biraz düşünmem gerekiyor sorunun, yetiştiremedim.

3-4) P₄: Burada şeklin yönü önemliydi, eğer ayna koyarsak şeklin yönü değişir.

B: Peki şekillerin aynı olup olmadığına nasıl karar verdin?

P₄ : Şekli kafamda çevirdim. Örneğin bu aynı değil, uzun kısım yön değiştirmiş.

5-6) P₄: Bu sorularda öncelikle katlanmış kenara baktım. Daha sonra da buraya göre noktanın simetriğini aldım. Bu buraya katlanmış o zaman nokta tam karşıda olacak.

P₄: Birden fazla katlama olan sorularda sondan başa doğru katlamayı açarak geldim. Daha sonra da simetriğini aldım sırasıyla noktaların.

7-8) P₄: Öncelikle katlayınca hangi kenarlar biraya gelir ona baktım. (eliyle katlama işlemini tekrarlıyor). Bunu buraya katlarsam bu kenar E olur burası da C olur. (eliyle katlama işlemini yapıyor ama kenarları nasıl eşleştireceğini bulamıyor.)

9) P₄: Bu şekil yeterli mi?

B: Evet, tamam. Şimdi de önden, yandan ve üstten görünümelerini çizeceksin.

P₄: Burayı ön kabul edersek, diğer taraf da yan oluyor. (sayarak çiziyor)

10) P₄: (Verilen şekillere bir süre sessizce bakıyor) Ben bunlarda şekli hayal etmekte zorlanıyorum. Şurası yan burası da ön olsun (yanlış)

B: Sıra sayılarına baktın mı?

P₄: Hayır, öylesine isimlendirmiştım, ama şimdi düşününce öyle olmaz, bi tanesinde 4 diğesinde 5 sıra var. tamam şimdi üstten görünümüne göre yerleştiriyorum. Burada 3 küp var, 3 kat koyuyorum yandan görünüşe göre ama önden görünüşe göre de aynı mı? (şekli deneme yanılma yöntemiyle oluşturuyor)

B: Tamam

P₄: Bunu çizmekte baya zorlanıyorum. İlk katı çizerek başlayım üstleri sonra çizerim.

P₄: Üstleri çizerken arkada kalan bazı küpler görünmeyecek onları sonra silerim. Üst kenarları kalınlaştırıyorum ve üst yüzleri de karalarsam şekli karıştırmam.

B: Tamam

P₄: Hala geriye ve yukarıya doğru çizmede problemim var.

2nd Task-Based Interview of P₄

11) P₄: Bu şekilleri hayalimde döndürmeye çalışıyorum.

Bir de farklı noktalar belirleyip birbirlerine göre aynı uzaklıkta, aynı yönde kalmaları gerekli bunu kontrol ediyorum. Sanırım cevap C.

12) P₄: Burada döndürmeye çalışıyorum şekil kolaya benziyor. Beyaz çapraz duracak, siyah düz. Bu da ipucu veriyor zaten. Cevap B.

13) P₄: Şu son soru biraz karışık çok fazla şekli kontrol etmek gerekiyor. Hepsini aynı anda düşünmek zor oluyor.

14) P₄: Küpleri kapatmak kolay aslında şu boşlar alta gelecek desek, üzerlerindeki şekillerin birbirlerine göre konumlarına bakacağız. Ama küp döndürülürse bu şekil elde edilebilir mi bunu düşünmek çok zor. Özellikle de bu ilk soruda üzerlerindeki şekiller simetrik ve aynı.

15-16) P₄: Diğeri daha kolay, şekiller asimetrik ve birbirlerine göre konumlarından sonuca ulaşmak daha kolay. 2 B ve 3 A ama ilkinden emin olamıyorum.

17) B: Şimdi de bu şeklin üstten, önden ve yandan görünüşlerini çizeceğiz.

P₄: Bunlar kolay, bunlarda zorlanmıyorum, burada ön ve yan kendim belirleyebilirim sanırım.

B: Evet, burada sorun olmaz.

P₄: Tamam burası ön olsun, burası da yan. (Sayarak çiziyor)

18) (Şekle bakıyor, uzun süre sessizce düşünüyor)

B: Nasıl bir yol izlemeyi düşünüyorsun?

P₄: Üstten ve yandan görünümlerine bakarak ikisinde de ortak olan küpleri buldum ama bunu nasıl 3 boyutlu çizebilirim bilmiyorum. Bu şekli öncelikle düz kağıda çizip sonra izometrik kağıda çizebilir miyim?

B: Tabii ki

P₄: (Üstten görünümün üstüne yandan görünümünden faydalanarak katları çıkıyor.) Şimdi bir kontrol edeyim. Yandan görünümü de düşünerek küplerin sayılarını eşitlemem gerek. P₄: Benim uzun sürecek çizimim sanırım. (Üstten görünüm sağlayacak şekilde düzeltmeler yapıyor). Şurasını fazla çizmişim. (Eşleştirmekte zorlanıyor, uzun süre düşünerek kontrol edip eşlemeye çalışıyor)

P₄: Son kez tekrar kontrol edeyim. Tamam bu şekli şimdi izometrik kağıda çizeyim. Bunda hala zorlanıyorum. Şimdi ilk katı çiziyorum. Üst katları da bu şekle göre çizeceğim. Ama görünüşler farklı.

B: Farklı açılardan çiziyorsun çünkü.

P₄: Evet, önceki çizimle farklı olacak. Arkaya ve üste giderken karışıyor. Yan yüzeylerle, üst yüzeyleri farklı renklere boyasam iyi olacak.

(Deneme yanılma yöntemiyle çiziyor)

3rd Task-Based Interview of P₄

19) B: Aşağıdakilerden hangisi verilen objeden farklıdır?

P₄: Kafamda şekli çeviriyorum, bu ilk şekilde içe bakan kısımla dış kısım yer değiştirmiş aynı değil. Diğerleri aynı.

20) P₄: Kağıt katlama testi sanırım. Ama bu noktalı kısmı anlamadım.

B: Bu cevap tablosu. Bulduğun noktaların bu tabloda hangilerine eşleştiğini bulacaksın.

P4:Tamam anladım. Aslında kağıt katlamada katlanılan yerleri önce belirliyorum. O yerlere göre karşı taraflarına noktaların aynısını çiziyorum. Bu tam ortadan katlanmış o zaman tam eşit uzaklıkta diğer nokta.

B: Şimdi de tabloda göster.

P4:Bu ikinci sırada mı 3. Mü acaba? (kalemle çizerek yerlerini eşleştiriyor) hımm 2D de o zaman diğeri de 5D de

21) P4: Burada iki katlama var ortalarından olduğu için kolay eşit uzaklıkta olacak. Dört nokta ortalara göre simetrik.

22) P4: Birden fazla katlama yapınca noktaları sondan başa doğru yerleştiriyorum. O zaman noktanın önce bu çaprazını alırım, sonra da diğerini açıyoruz.

23) B: Bu cismin de üstten, önden ve yandan görünümünü çizeceksiniz.

P4: Bunlar kolay, sayarak çiziyorum. Burası ön, burası yan olsun. Üstten başlayarak çiziyorum.

24) B: Son olarak, üstten, önden ve yandan görünümü verilmiş olan cismin izometrik kağıda çizmen gerekiyor.

P4: Önce şekli kafamda oluşturmaya çalışıyorum.

P4:Sayıları farklı demek ki burası ön burası da yan. Eşleştirirsek, şurası iki katlı (üstten görünüm üzerinden gösteriyor) Buradan başlıyorum çizmeye. (sırayla bularak çizmeye başlıyor) Yukarı böyle gidiyorduk sanırım arkasıyla hala karıştırıyorum da bazen. Üstlerini karalıyorum, yukarıya doğru olan çizgileri de da koyulaştırıyorum. Böyle daha iyi görüyorum.

P4: Şu arkadaki küp görünmemeliydi siliyorum. (uzun sürüyor ama çiziyor)

25) B: Bana bu soruyu anlatarak yapar mısın?

P4: Katlanmasını hayal etmeye çalışıyorum. Yüzeylerin benzer olanlarını eşleştiriyorum bir de belirgin kenarları katlıyorum daha kolay oluyor. Ama şekil karışıklaştıkça görmem zorlanıyor. Şunları şöyle katlıyoruz (eliyle tekrarlıyor), şu da üstüne gelse, alta da bunlar gelse (yüzeyleri boyayarak bulmaya çalışıyor)

1st Task-Based Interview of P5

1-2) P5: Bütün sorular için aynı olmayabilir ama önce birinci ve ikinci küpün yüzeylerine baktım ve ikinciyi elde etmek için birinciyi çevirdim. Örneğin O her

yöne çevirilebilir. Eğer şekil simetrikse ben de diğer şekilleri kontrol ettim, T gibi örneğin. Diğer şekillerin yerini T ye göre sabitledim. Ama zaman yetmedi daha pratikleşmem gerek sanırım.

3-4) P₅: Bunu hayal ederek yapıyorum, kafamda döndürmeyi buluyorum ve sonra da asimetrik parçaların konumlarını kontrol ediyorum.

P₅: Eğer bir şeklin aynı olduğunu düşünürsem, diğer şekli onunla kontrol ediyorum, çünkü döndürülmüş şekli döndürmek daha kolay geliyor.

5-6) P₅: Zor olanları vardı. Noktaların simetrilerini bulmaya çalıştım, son katlamadan başladım açarak geri geldim.

P₅: Hayalimde katlamayı açmaya çalıştım. Ama şu soruda katlamayı anlamadım. Altı boş olanları anlamamış olabilirim. Yapabildiklerimi yaptım.

7-8) P₅: Bu en zor olanıydı. 3 boyutlu cisimden başladım ve X yüzeyinin etrafındaki kenarları kontrol ettim. Zor şekillerde bunu yapamadım tabii.

10) P₅: Bu nasıl bir şekle ait olabiliyor? (Soruyu anlamıyor)

B: Aslında bir önceki soruda çizdiğin gibi, bu sefer senin çizdiklerin gibi görünüşleri vermiş cismi istiyor.

P₅: (soru üzerinde bir süre düşünüyor) Bu üç görünüşü eşleştirmem gerek ama çok zor görünüyor. Üstten görünüşle başlayacağım ve ordaki her küp için diğer iki görünümü eşleştireceğim. Ama ön neresi yan neresi oluyor acaba?

B: Sıralardaki küp sayılarını kontrol et istersen.

P₅: Aaa evet. Eşleştirmeye başlıyorum. Şimdi burada 4 küp var, bir dakika, hayır 3 küp var. (deneme yanılma yoluyla cismi oluşturuyor)

B: Şimdi de izometrik kağıda çizelim.

P₅: İzometrik kağıda çizeyim şimdi ama arkaya nasıl gidiyorduk. (çizimde zorlanıyor)

B: O zaman hatırlayalım.

P₅: Tamam bu küp olsun arkaya böyle yukarıya böyle gidiyorduk. (çizerek gösteriyor)

B: Evet doğru.

P₅: Tamam o zaman bu ön sütundan başlıyorum. Bunun 2 yanındakinin üç katı var.

P₅ : Arka taraflarda görünmeyen küpler olacak. Çizimi daha iyi anlamak için boyayacağım.

2nd Task-Based Interview of P₅

11) P₅: Döndürerek aynısını mı oluşturacağız.

B: Evet

P₅: Şimdi kafamda döndürmeye çalışıyorum (eliyle döndürme hareketi yapıyor)

Bu noktaların birbirlerine göre konumları aynı kalmalı, bunu da kontrol edeceğiz.Cevap bu

12) P₅: Bu soru kolay, aralarındaki uzaklık sabit kalacak, bir de koyu olan hep sağda kalacak. O zaman B.

13) P₅: Şu son soru da karıştırdım, şekiller birbirine benziyor, kontrol etmekte zorlanıyorum.

14) P₅: Katlayıp küp oluşturuyoruz.

B: Evet

P₅: Şimdi şu köşeyi şöyle katlayalım (eliyle katlama hareketi yapıyor)

P₅: Şimdi kapatırsak bu üçüncü buraya gelir mi acaba? Birinciyle üçüncü arasında kararsız kaldım.

P₅: Üzerindeki şekillerin birbirlerine göre konumlarını sabit tutmaya çalışıyorum, kapatınca ne tarafında kalır diye konumlarına bakıyorum ama 3. Şekillerde zorlanıyorum.

15) P₅: Bu kolay şekiller farklı olduğu için birbirlerine göre durumlarına bakarsam bu ikinci olacak. Bir tek o sağlıyor.

16) P₅: Burada da şekillere bakıyorum bir tek ilki sağlıyor.

17) B: Şimdi de bu şeklin üstten, önden ve yandan görünüşlerini çizeceğiz.

P₅: Tamam burası ön olsun burası da yan olsun.

Şimdi sayarak çizelim. Yalnız şu arkadaki uzantı kaçınıcı küpten başlıyor algılayamıyorum. Sanırım şu birinciden başlıyor

18) P₅: İzometrik kağıda çizmekte pek zorlanmıyorum ama şekli kafamda oluşturmak zor oluyor baya.

(Kağıdı çeviriyor) Burası mı ön anlayamadım.

P₅: Şurası ön şurası da yan sanırım. Sayıları farklıymış zaten.

P₅: İzometrik kağıda çizerim onda bir sorun yok ama şekli oturtamadım.

(Üstten görünüm üzerine yandan ve önden görünümleri kullanarak kat çıkmaya çalışıyor ama eşleştirmekte zorlanıyor.)

(üstten görünümün üzerine kat sayılarını yazarak eşleştiriyor)

P₅: Tamam şu köşeden başlıyorum. Ama bu arkası görünmeyecek sanırım, onu nasıl belirteceğim. Öndekileri daha koyu çizersem belli olur.

Arkada görünmemesi gerekenleri siliyorum. Dikey kenarları koyulaştırıyorum daha rahat ayırt etmek için. Üstlerini de boyuyorum, yoksa üstlerle yan yüzeyler karışık görünüyor. (çiziyor)

3rd Task-Based Interview of P₅

19) B: Aşağıdakilerden hangisi verilen objeden farklıdır?

P₅: Şimdi kafamda bu şekli çevirmeye çalışıyorum.

B: Evet

P₅: Burada kontrol etmek için asimetric olan köşelere bakıyorum. Burada bu iki köşenin birbirlerine göre yönlerinin sabit kalması gerekir.

20) P₅: Bunlarda pek zorlanmıyorum. Katlamayı sondan başa doğru düşünüyorum, katlama noktalarından simetri alıyorum.

B: Tabloda göstereceksin cevaplarını.

P₅: Haaa, tamam. Noktanın hangisi olduğunu bulmam lazım. Nokta 2D de, katlama da 3. Sıradan sanırım.(düşünüyor) Ama böyle olmuyor gibi, katlama arada olabilir mi?

B: Öyle bir kısıtlama yok tabii olabilir.

P₅: Tamam o zaman şuradan katlanmış (katlama yerini çiziyor). Buna göre simetri alacağız.

21) P₅: Burada iki katlama var önce şöyle, sonra da şöyle (eliyle katlamayı tarif ediyor) Sondan başa doğru açacağım. İlk önce son katlama şuradan (Çiziyor) buna

göre simetrisi bu nokta. Şimdi bunların ilk katlamaya göre simetrisini alırsam sonuç D şıkkı.(D)

22) P₅: Bu soruda katlama biraz daha karışık Yine sondan başlıyorum. Bu nokta hangisi olabilir (çizerek tabloyla yerlerini eşleştiriyor) 3A da şimdi buradan katlanmış (katlama yerini çiziyor) 2A oluyor şimdi altı açalım. Bu nereye gelebilir, bu da bu köşeye gelmeli.(D)

23) B: Bu şeklin üstten, önden ve yandan görünüşlerini çizeceksin.

P₅: Bunlarda pek zorlanmıyorum. Önce üstten çiziyorum. Şu yandaki bölüm karışık gibi görünüyor. (kalemle çizerek sırasına emin oluyor) Tamam bu sırada. (sayarak çiziyor)

24) P₅: Ben bu sorularda önce şekli kafamda oluşturuyorum. Alt sıra üstten görünüm olsun diyorum. Önden 4 yandan 5 sıra olduğuna göre burası ön burası yan (işaretliyor) Şimdi yandan kaç kat olması gerek bakıyorum yanlarına yazacağım, önleri de yazıp eşleştireceğim. (sayıları yazıyor eşleştirerek hangi sıranın kaç katlı olduğunu buluyor)

B: Tamam, şimdi de izometrik kağıda çizelim

P₅: Ben bunları çiziyorum ama renklendirirsem şekli daha rahat algılıyorum, yoksa üstlerle, arkadakileri karıştırıyorum.

B: tamam istediğin gibi yapabilirsin.

P₅: Şu ön köşeden başlıyorum, arkaya doğru ilerleyeceğim. Üstleri kırmızıyla boyayayım, yanları da bu kalemle koyulaştırayım. Şu arkadaki görünmeyenleri sonradan siliyorum.

25) B: Burada açık ve kapalı hali verilmiş bu cismin kenarlarını eşleştireceğiz.

P₅: Bunda baya zorlanıyorum. Önce bu X yazan yüzeyleri eşleştiriyorum. Buradan itibaren kafamda açmaya çalışıyorum. Belirgin kenarlar varsa eşleştirmem daha kolay. Ama şekil karışıklaştıkça zorlanıyorum. Bir de yapışan kenarlar aynı yerde olacak bunlara da dikkat etmem gerekiyor. Şimdi şurası katlanınca nasıl alta geliyor göremiyorum

VITA

PERSONAL INFORMATION:

Surname, Name: Kayhan, Emine Banu
Nationality: Turkish (TC)
Date and Place of Birth: 12 June 1979, Mersin
Marital Status: Married
Phone: +90 3124958803
Email: banukayhan@yahoo.com

EDUCATION:

Degree	Institution	Year of Graduation
MS	METU SSME	2005
BS	METU SSME	2002
High School	Mersin Özel Toros Lisesi	1997

WORK EXPERIENCE

Year	Place	Enrollment
2006-Present	MEB Bahçelievler Anadolu Lisesi	Mathematics Teacher
2002-2006	MEB Beypazarı Endüstri Meslek Lisesi	Mathematics Teacher

ACADEMIC STUDIES

1. Kayhan, E. B., & Bulut S. (2001, May). Circular Areas. Poster Session presented at the Mathematics Activities Symposium and Exhibition, ANKARA.

2. Kayhan, B. ve Bulut, S., Lise Öğrencilerinin Mantıksal Düşünme Yetenekleri ile Uzamsal Yetenekleri Arasındaki İlişkiler. "XV. Ulusal Eğitim Bilimleri Kongresi", (2006), s.453.

3. Kayhan, E.B. ve Bulut, S., Teknik Resim Dersinin Lise Öğrencilerinin Uzamsal Yönelim Yetenekleri Üzerindeki Etkisi. "VII. Ulusal Fen Bilimleri ve Matematik Eğitimi Kongresi", (2006), s.236.