

PERFORMANCE BASED FAÇADES: RETROFIT STRATEGIES FOR ENERGY  
EFFICIENCY AND COMFORT IN EXISTING OFFICE BUILDINGS

A THESIS SUBMITTED TO  
THE GRADUATE SCHOOL OF NATURAL AND APPLIED SCIENCES  
OF  
MIDDLE EAST TECHNICAL UNIVERSITY

By

NEGIN JAHED

IN PARTIAL FULFILLMENT OF THE REQUIREMENTS  
FOR  
THE DEGREE OF MASTER OF ARCHITECTURE  
IN  
ARCHITECTURE

JANUARY 2018



Approval of the thesis:

**PERFORMANCE BASED FAÇADES: RETROFIT STRATEGIES FOR  
ENERGY EFFICIENCY AND COMFORT IN EXISTING OFFICE  
BUILDINGS**

Submitted by **NEGIN JAHED** in partial fulfillment of the requirements for the degree  
of **Master of Architecture in the Department of Architecture, Middle East  
Technical University** by,

Prof. Dr. Gülbin Dural Ünver  
Dean, Graduate School of **Natural and Applied Sciences**

\_\_\_\_\_

Prof. Dr. Elvan Altan  
Head of Department, **Architecture**

\_\_\_\_\_

Assist. Prof. Dr. İpek Gürsel Dino  
Supervisor, **Architecture Department, METU**

\_\_\_\_\_

**Examining Committee Members:**

Prof. Dr. Mualla Erki1iç  
Architecture Department, METU

\_\_\_\_\_

Assist. Prof. Dr. İpek Gürsel Dino  
Architecture Department, METU

\_\_\_\_\_

Assoc. Prof. Dr. Ali Murat Tanyer  
Architecture Department, METU

\_\_\_\_\_

Assoc. Prof. Dr. Gülsu Ulukavak Harputlugil  
Architecture Department, Çankaya University

\_\_\_\_\_

Assist. Prof. Dr. Çaęla Meral  
Civil Engineering Department, METU

\_\_\_\_\_

**Date:**

\_\_\_\_\_



**I hereby declare that all information in this document has been obtained and presented in accordance with academic rules and ethical conduct. I also declare that, as required by these rules and conduct, I have fully cited and referenced all material and results that are not original to this work.**

Name, Last Name: Negin JAHED

Signature:

## **ABSTRACT**

# **PERFORMANCE BASED FAÇADES: RETROFIT STRATEGIES FOR ENERGY EFFICIENCY AND COMFORT IN EXISTING OFFICE BUILDINGS**

Negin Jahed

M.Arch., Architecture, Department of Architecture

Supervisor: Assist. Prof. Dr. İpek Gürsel Dino

January, 2018, 242 pages

The building industry is faced with a vast stock of existing buildings that are not sustainable and suffer from poor conditions in terms of physical problems. Energy retrofitting of existing buildings is considered as a rational strategy to minimize buildings' environmental impact in the long term. Standard building retrofits focus on prescriptive measures to comply with energy standards rather than occupant requirements. In contrast, the proposed performance-based retrofit approach focuses, primarily on indoor comfort to leverage the non-energy benefits of retrofit besides the strategies to improve the energy performance of the building. Specifically, in the case of office buildings, most of the energy saving options and required high levels of indoor comfort are in conflict with each other and need to be balanced. This study argues the current approaches to the façade retrofit decisions in the case of existing office buildings in mixed-dry climates by incorporating both values of energy efficiency and indoor comfort issues considering different office spatial organizations. The main contribution is presenting the state-of-the-art in building energy retrofit and proposing a performance-based façade retrofit framework, which can be used by stakeholders and end users throughout the initial stages of a retrofit process. It can also form the basis of decision support tools that can be developed in the future.

Keywords: Energy retrofit, Existing office buildings, Façade retrofit, Spatial comfort.

## ÖZ

# PERFORMANSLI TEMEL CEPHELER: MEVCUT OFIS BİNALARINDA ENERJİ VERİMLİLİĞİNİ VE KONFORUNU GELİŞTİRME STRATEJİLERİ

Negin Jahed

Yüksek Lisans, Mimarlık, Mimarlık Bölümü

Tez Yöneticisi: Assist. Prof. Dr. İpek Gürsel Dino

Ocak 2018, 242 sayfa

Mevcut binaların enerji yenilenmesi, binaların uzun vadedeki çevresel etkilerini düşürmek için mantıksal bir strateji olarak düşünülür. Standart bina yenilemeleri, yolcu gereksinimlerinden ziyade enerji standartlarına uymak için önleyici tedbirlere odaklanır. Buna karşılık, önerilen performansa dayalı yeniden kurulum yaklaşımı, binanın enerji performansını iyileştirme stratejilerinin yanısıra yenilemenin enerji dışı yararlarından faydalanmak için öncelikle iç mekan konforuna odaklanmaktadır. Özellikle, ofis binaları söz konusu olduğunda, enerji tasarrufu seçenekleri ve istenen yüksek iç mekan konforu dengelenmesi gerekir. Bu çalışma, karmaşık iklim koşullarındaki mevcut ofis binaların cephe yenileme kararlarına ilişkin mevcut yaklaşımları ve farklı ofis mekansal organizasyonlarını dikkate alarak her iki enerji verimliliği ve iç mekan konforu değerlerini de dahil ederek tartışmaktadır. En büyük katkı, enerji yenilemesinin inşasında ve yenileme sürecinin ilk aşamalarında paydaşlar ve son kullanıcılar tarafından kullanılabilen performansa dayalı bir cephe yenileme çerçevesi önermektedir. Ayrıca gelecekte geliştirilebilecek karar destek araçlarının temelini oluşturabilir.

Anahtar Kelimeler: Enerji yenilenmesi, Mevcut ofis binaları, Cephe yenileme, Konumsal konfor.



*To my beloved family*

## ACKNOWLEDGMENTS

Foremost, I would like to express my heartfelt thanks gratitude to my thesis supervisor, Assist. Prof. Dr. İpek Gürsel Dino for her continuous guidance, support, motivation, and encouragement throughout the study. In these years, she has always been a source of inspiration for me.

Besides my advisor, I would like to thank the other members of my thesis committee, Prof. Dr. Mualla Erkılıç, Assoc. Prof. Dr. Ali Murat Tanyer, Assist. Prof. Dr. Çağla Meral, and Assoc. Prof. Dr. Gülsu Ulukavak Harputlugil for providing me kind support and confidence to successfully complete the thesis.

I would like to thank my family to whom I owe a great deal. To the infinite soul of my late mother Ashraf. She taught me to face the challenges with faith and humility. Although she is not here to give me strength and support I always feel her presence that used to urge me to strive to achieve my goals in life. To my father, who taught me to be diligent in my academic achievements. I owe my deepest and warmest thanks to my dear brother Hamed for his endless support and patience during my life and to my sister in law Golnaz for providing me with continuous encouragement whenever I face challenge in my life.

Last but not the least; I would like to express my affection and gratitude to my dear friend Kian for always promoting me and believing in me throughout my studies. I also appreciate my dear friends, Ayda hamidkargari, Yasamin Dehghan, Sanam Dehghan, and Emine Gündoğan. Thank you all.



## TABLE OF CONTENTS

ABSTRACT.....	i
ÖZ.....	ii
ACKNOWLEDGMENTS.....	iv
TABLE OF CONTENTS.....	v
LIST OF TABLES.....	viii
LIST OF FIGURES.....	ix
CHAPTERS	
1. INTRODUCTION.....	1
1.1. Background: Reasons for Concern .....	1
1.2. Motivation: Existing Past and Demanding Future.....	6
1.3. Problem Statement.....	7
1.4. Aims and Objectives.....	11
1.5. Research Questions.....	12
1.6. Scope of The Thesis.....	12
1.7. Thesis Methodology .....	13
1.8. Thesis Structure .....	14
2. BUILDING ENERGY PERFORMANCE AND RETROFIT PRACTICES .....	17
2.1. Commercial Building Composition and Energy Use by Sector .....	18
2.2. Profiles of Building Industry Energy Use in U.S .....	19
2.3. Contemporary Retrofit Practices .....	20
2.3.1. Retrofit practices in U.S.....	21
2.3.2. Profiles of building industry energy use in Turkey .....	22
2.3.2.1. Turkey’s building energy regulation.....	23
2.3.2.2. Retrofit practices in Turkey .....	25
2.4. Building Energy Retrofitting: Definition.....	25

2.4.1. Building energy retrofitting: application levels.....	29
2.4.2. Energy retrofitting challenges and barriers .....	31
2.5. Energy Retrofitting of Commercial Office Buildings.....	32
2.6. Main Building Stakeholders and Their Roles in Energy Retrofitting.....	34
2.7. Roadmap Development for Energy Retrofits.....	36
2.7.1. Key phases of a building energy retrofit process .....	37
2.8. Benefits and Constraints of Passive Strategies .....	39
2.9. Pre-Defined Conditions of the Existing Building .....	40
2.9.1. Opaque and transparent façade.....	41
2.9.2. Thermal load profiles in office buildings .....	41
2.9.3. The impact of the building’s orientation and form on developing passive retrofit process .....	45
3. OFFICE ORGANIZATION AND ITS ELEMENTS .....	47
3.1. Different Methods in the Definition of Office Organization .....	48
3.1.1. Predominant spatial arrangement concepts from past to present .....	49
3.1.2. Duffy’s office environment framework.....	56
3.1.2.1. Duffy’s office environment framework: generic work patterns....	56
3.1.2.2. Duffy’s office environment framework: spatial arrangements .....	57
3.1.2.3. Duffy’s office environment framework: depth of plan .....	59
3.2. Spatial Comfort in Office Environments .....	62
4. RETROFIT FRAMEWORK DEVELOPMENT.....	69
4.1. Identifying Pre-Defined Characteristics of the Existing Building for Improving Energy Performance: Building Scale .....	70
4.2. Developing a Spatial Comfort Framework for Five Different Office Layouts: Room Scale .....	81
4.2.1. Spatial comfort framework for peripheral and internal offices.....	96
4.3. Effective Passive Retrofitting Actions on Existing Façade Systems in Mixed-Dry Climates: Façade Scale .....	100
4.3.1. Façade Retrofit Framework.....	101
5. GENERAL GUIDELINES TO USE THE PROPOSED FRAMEWORK .....	123

6. DISCUSSION AND CONCLUSION..... 129

REFERENCES..... 135

APPENDICES

    A. SPATIAL COMFORT FRAMEWORK FOR PERIPHERAL OFFICE  
    ZONES ..... 155

    B. SPATIAL COMFORT FRAMEWORK FOR INTERNAL OFFICE ZONES... 163

    C. DETAILS OF PASSIVE ACTIONS IN FAÇADE RETROFIT  
    FRAMEWORK..... 172



## LIST OF TABLES

### TABLES

Table 2.1. Definition of intervention activities (Giebeler, 2005) .....	26
Table 2.2. Different application scales of energy retrofitting (based on Rey, 2004; PCA & Arup, 2009; and Rajapaksha et al., 2013). .....	30
Table 2.3. Different application scales of façade energy retrofitting (Rey, 2004) .....	31
Table 2.4. Concern areas of the thesis in developing the retrofit framework.....	36
Table 2.5. Thermal load profiles in office buildings and their impacts on energy usage and comfort (Rajapaksha et al., 2013).....	44
Table 3.1. Summary of pre-dominant office layouts from early 1960s till present. ...	55
Table 3.2.Types of spatial arrangements and their needs (Duffy et al., 1976).....	58
Table 4.1. Summarized Duffy’s space depth dimensions and provided passive zone in each type (based on Duffy et al., 1976).....	93
Table 4.2. Spatial arrangement details for five different office layouts .....	95
Table 4.3. Hierarchical structure of performance framework. ....	97
Table 4.4. Spatial comfort framework for peripheral office zones .....	98
Table 4.5. Spatial comfort framework for internal office zones .....	99
Table 4.6. Façade retrofit framework for improving thermal comfort.....	102
Table 4.7. Façade retrofit framework for improving visual comfort.....	112
Table 4.8. Façade retrofit framework for improving audial comfort .....	117
Table 4.9. Presented passive retrofit actions .....	119
Table 4.10. The total number of presented actions for each comfort domain.....	120
Table 4.11. Relationship Matrix: identifying the interaction of retrofit actions.....	120
Table 4.12. Conflicted actions and the alternative performances within the retrofit framework.....	121

## LIST OF FIGURES

### FIGURES

Figure 1.1. Climate risk analysis (The IPCC-AR5, 2013).....	2
Figure 1.2. Color-changing lake within only three months, Lake Urmia, Iran (NASA: Images of change, 2016). .....	2
Figure 1.3. GHG emissions per capita for 1990-2014 (Turkish Statistical Institute, 2016). .....	4
Figure 1.4. Thesis structure .....	15
Figure 2.1. Commercial construction (McGraw-Hill Construction, Construction, 2010, p.6). .....	18
Figure2.2. Commercial building types and energy consumption (McGraw-Hill Construction, 2010).....	19
Figure2.3. Commercial primary energy end-use (McGraw-Hill Construction, Construction, 2010).....	20
Figure 2.4. The 2030 challenge (Architecture 2030, 2013b) .....	22
Figure 2.5. Various types of retrofit actions (Giebeler, 2005).....	27
Figure 2.6. Life span of building systems (Giebeler, 2005).....	29
Figure 2.7. Office environment components and their lifespans (Stratton, 1997).....	33
Figure 2.8. IDEF0 diagram of a systematic retrofit roadmap .....	39
Figure 2.9. The Trias Energetica concept (Lysen, 1996) .....	40
Figure 2.10. Environmental loads and façade performance (Carlson and Martinez Arias, 2014).....	42
Figure 3.1. Major elements of office organization (Palmer and Lewis, 1977). .....	47
Figure 3.2. Principles of different office concepts (Van Meel, 2000). .....	50
Figure 3.3. Evolution of single office concept from pre-1950 till mid-1960s (Palmer & Lewis, 1977).....	51

Figure 3.4. Open plan office in mid-60s, rigid arrangements (Palmer & Lewis, 1977).....	52
Figure 3.5. Spatial arrangement concepts from 1970s till today (Palmer & Lewis, 1977).....	53
Figure 3.6. Duffy’s work typology (Harrison et al., 2004, p. 27). .....	56
Figure 3.7. Left: shallow space and core position type, right: medium-depth space (Duffy et al., 1976) .....	60
Figure 3.8. Left: deep space, right: very deep space (Duffy et al., 1976) .....	61
Figure 3.9. Different depth spaces (Duffy et al.,1976) .....	62
Figure 3.10. Theoretical framework of office productivity (Haynes, 2007) .....	63
Figure 3.11. Environmental comfort model of workspace quality (Vischer, 2008)....	64
Figure 3.12. Physical work environment factors that impact on worker (By the author, based on Shea et al., 2011). .....	65
Figure 3.13. The interdependent relation among indoor comfort, spatial arrangements, and façade performance.....	66
Figure 3.14. The general structure of proposed retrofit actions in the Retrofit Framework.....	66
Figure 3.15. The three-step process of retrofit framework.....	67
Figure 4.1. Interdependent relationship among three scales. ....	69
Figure 4.2. Effective pre-defined condition of the existing building on the performance of passive actions.....	71
Figure 4.3. Considered four types of building shape in this thesis; deep, shallow, atrium, and courtyard .....	73
Figure 4.4. Total energy consumption for seven plan aspect ratios (Raji, et al., 2017).....	74
Figure 4.5. Effects of window-to-wall ratio for mixed, dry 4B climatic zones (Aksamija, 2013) .....	75
Figure 4.6. The optimal percentage of window-to-wall ratio for two plan types (1:1 and 5:1) in temperate climate (Raji et al., 2017).....	76

Figure 4.7. Above: R1 ratio, below: R2 ratio of rectangular courtyards in examining their energy consumption rates (Muhaisen and Gadi, 2006). .....	78
Figure 4.8. The models of atrium and courtyard (Aldawoud and Clark, 2008).....	79
Figure 4.9. Integrated usage of courtyard / atrium (Tabesh & Sertyesilisik, 2016).....	81
Figure 4.10. Developing spatial comfort framework for different office layouts.....	82
Figure 4.11. Considered five office plan type.....	83
Figure 4.12. Mono office plan.....	84
Figure 4.13. Multi office plan .....	85
Figure 4.14. Mass-rigid office plan.....	87
Figure 4.15. Mass-flex office plan .....	88
Figure 4.16. Mobile office plan .....	89
Figure 4.17. Passive zone ratio (Baker, 2009; Baker & Steemers, 2000).....	90
Figure 4.18. positions' of peripheral, 2nd row, and 3rd row office zones (Reinhart, 2002). .....	91
Figure 4.19. Peripheral zones (strong passive areas) and internal zones (partially passive areas) (based on Baker, 2009; King, 2009; and Reinhart, 2002). .....	92
Figure 4.20. Passive zones in deep (above) and very deep spaces (below).....	93
Figure 4.21. Passive retrofitting criteria applicable on existing façade system.....	100
Figure 4.22. Light and heat transmission through glass .....	110
Figure 5.1. IDEF0 diagram of a systematic retrofit roadmap .....	123
Figure 5.2. General structure of proposed Retrofit Framework.....	124
Figure 5.3. IDEF0 diagram of a systematic retrofit roadmap .....	125
Figure 5.4. Flowchart diagram for establishing thermal comfort .....	126
Figure 5.5. Flowchart diagram for establishing visual comfort.....	127
Figure 5.6. Flowchart diagram for establishing audial comfort.....	128





## CHAPTER 1

### INTRODUCTION

*“The only way forward, if we are going to improve the quality of the environment, is to get everybody involved.” ~ Richard Rogers*

#### **1.1. Background: Reasons for Concern**

Over the last 150 years, human activities have led to an alarming level of greenhouse gas emissions in the atmosphere and consequently global warming (IPCC, 2007). Climate change, or the drastic shifts in the existing climate patterns results in severe weather conditions, arctic ice melts, rising sea levels, and deforestation, which in return threaten agriculture, health, water supply, infrastructure, and more. According to Wagner et al (2016), population growth and energy use per person will point to a 2C rise by 2030. The climate risk analysis presented in Figure 1.1, illustrates that an increase of 1 °C in the 21th century means serious climatic changes all around the world. The 2°C level in the global climate temperature is considered by scientists as a tipping point and crossing this point is equal to catastrophic results.

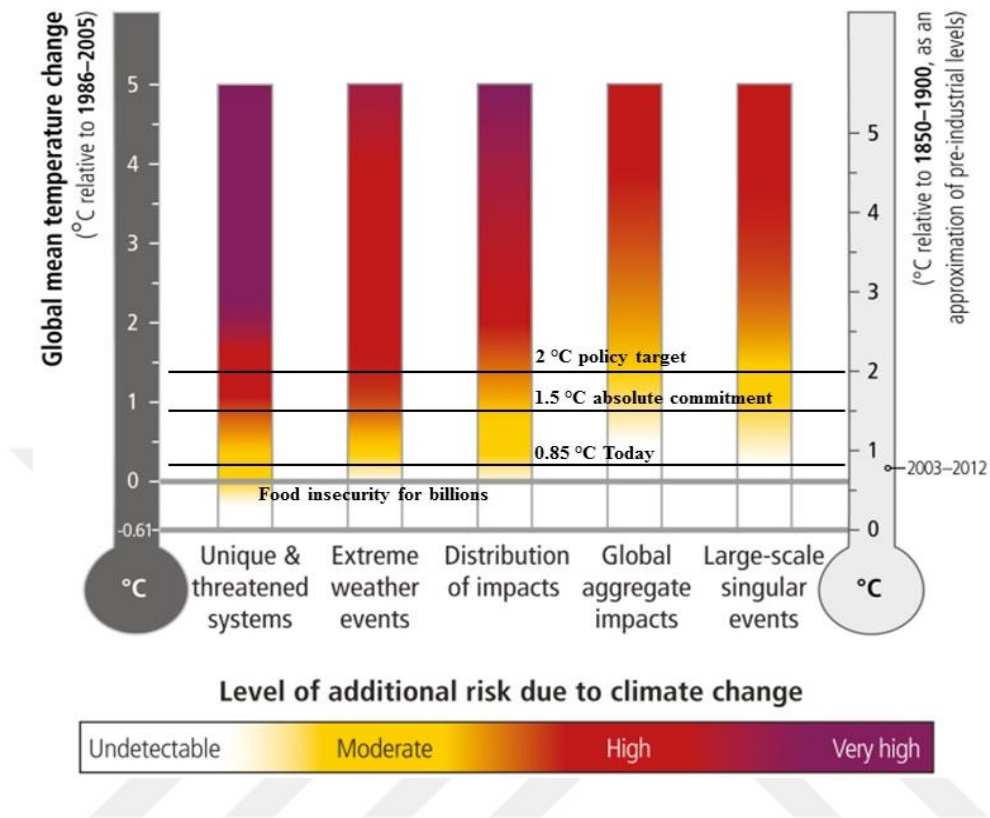

**Figure 1.1.** Climate risk analysis (The IPCC-AR5, 2013).

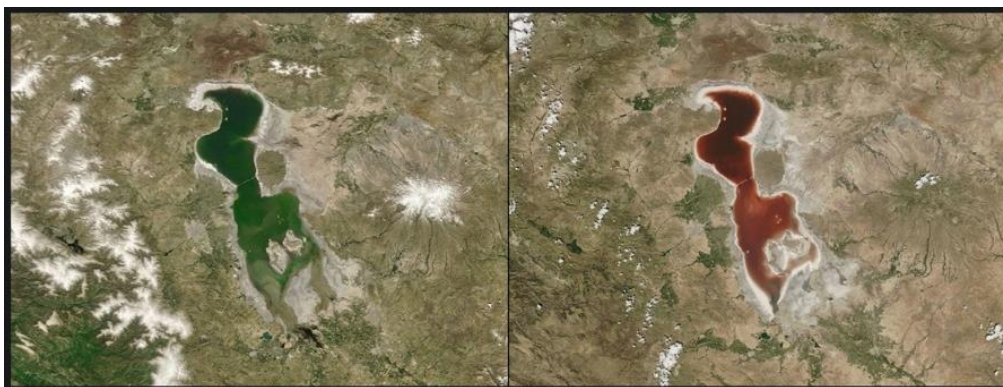

**Figure 1.2.** Color-changing lake within only three months, Lake Urmia, Iran (NASA: Images of change, 2016).

## **Is it too late to prevent climate change?**

In this situation, even if greenhouse gas emissions are completely halted today, the global warming trend would continue for at least several more decades. This is because of the high greenhouse gas concentration in the atmosphere as a result of centuries of industrialization and urbanization. Carbon dioxide, as the predominant heat-trapping gas, remains in the atmosphere for almost hundreds of years. In the lack of major action to reduce emissions, global temperature is on track to rise by an average of 6 °C (The IPCC-AR5, 2013). Some scientists argue a “global disaster” is already unfolding at the poles of the planet. The Arctic, for example, may be ice-free in summers within just a few decades. However, it may not be too late to limit some of the worst effects of climate change. NASA (2016) indicates two approaches in responding to climate change: 1) *mitigation*, which is reducing the greenhouse gases emissions; and 2) *adaptation*, which is learning to live with, and adapt to, the climate change. However, if we wait until we feel the amount or impact of global warming has reached an intolerable level, we will not be able to hold the line at that point and some further warming will be unavoidable.

## **Turkey Situation**

In a joined report conducted by Germanwatch and the Climate Action Network (CAN) during the U.N. climate summit in Lima, the world’s 58 highest CO<sub>2</sub> emitter countries are listed. These 58 countries together are producing almost 90% of all greenhouse gas emissions. The report ranks each country based on their level of efforts in dealing with the problem. In the last version of this report (CCPI, 2017), as seen in Figure 3, in 2016 Turkey with a rank of 51<sup>st</sup>, which is around the bottom of the list is labeled in the group of very poor performers in terms of energy efficiency and climate policy (Burck, Marten, and Bals, 2017).

### GHG emissions per capita, 1990 - 2014

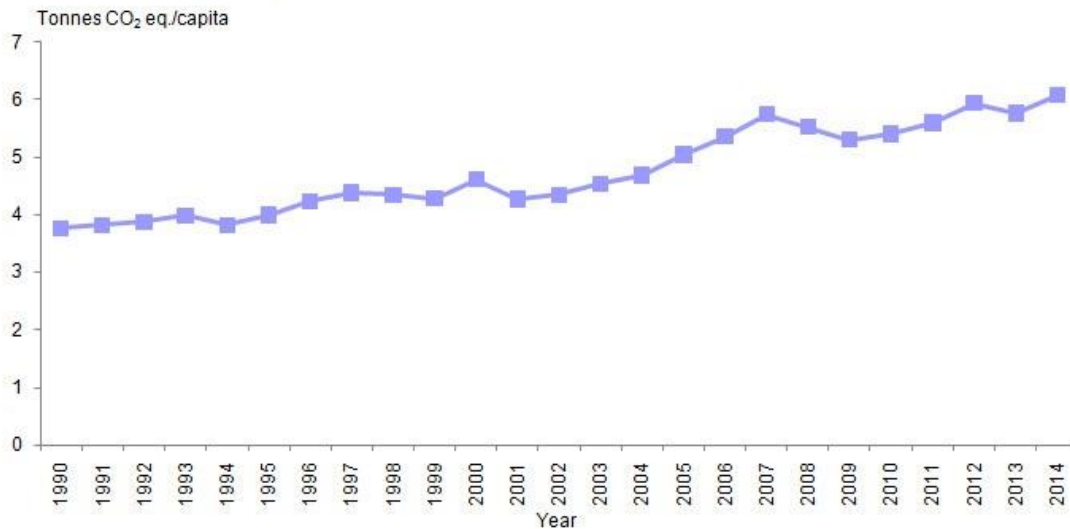

**Figure 1.3.** GHG emissions per capita for 1990-2014 (Turkish Statistical Institute, 2016).

According to Turkish Statistical Institute (2016), the largest portion of the Turkey's GHG emissions in 2014 was attributed to the energy sector with around 72.5% of the overall GHG emissions. The following sectors were industrial processes and the agricultural activities with respectively 13.4% and 10.6%. Figure 4 illustrates the total GHG emissions since 1990 till 2014, which shows a growth near 125% between these years.

### **What are our responsibilities, as architects or engineers?**

Regarding the complex nature of the global climate change, this problem relates to the economic, social, and political areas. Furthermore, the solution should embrace in both scales of globally-coordinated and local efforts. Globally-coordinated level comprises the international policies between countries, which stimulate the governments, for example, to mitigate their CO<sub>2</sub> emissions and adopting clean energy strategies. In the local scale, efforts are focused on the urban and regional level, such as improvements in transportation, energy efficient construction, sustainable urban planning, etc.

(NASA, 2016). These two scales are elaborated by environmentalists into three strategies of *reduce*, *reuse*, and *recycle*, which are known as three *Rs* of environmentalism. Researchers call these three *Rs*, as incremental tweaks that in the case of construction industry, can be implemented in variety forms. The fourth *R* is added by Bergman (2012, p.12), called *rethink*. He defines this category as “taking a step back” or trying to ask ourselves, what we are aiming to accomplish. By rethinking some already cherished assumptions in architectural design and the building industry, new concepts can emerge that can support energy performance and comfort improvements. Amongst the responsibilities of architects, (i.e. professionally, artistic, financial obligations), taking action against climate change accounts as an ethical responsibility towards the public in a rather larger scale.

### **Why the building industry?**

Based on the previously-mentioned issues, it is clear that there is a strong relationship between climate change and energy consumption in the fields of industry, transportation, agriculture, etc. However, the role of the building industry in this global climate crisis is greater than expected (Bergman, 2012, p.15). In order to reduce GHG emissions, the share of built environment in this crisis needs to be clarified. Buildings are responsible for almost 33% of global energy-related CO<sub>2</sub> emissions. More than 60% of the world’s electricity is consumed in residential and commercial buildings (IEA 2008a). Buildings’ indirect and embodied energy usage is also substantial, which is not comprehensively addressed in global statistics. Buildings and their poor performance are human-made, and their need for energy conservation strategies is more critical (Bergman, 2012). The considerable share of building sector in total energy consumption of the world, besides the fact that modern human beings spend more than 90% of their time in indoor environments, leads to an increased awareness of buildings performance (Leech et.al, 2002).

Commercial buildings, globally, are among the primary energy consumers. Between 2010 and 2050, global heating and cooling needs are expected to increase by 84% in

commercial buildings and by 79% in residential buildings (Ürge-Vorsatz et al., 2015). Additionally, studies have shown that commercial buildings carries a great energy saving potential. Among the commercial sector subdivisions, office buildings have the highest energy consumption rates, which is elaborated in Section 2.1. The major energy end-use in office buildings attributes to the energy demands for lighting and space heating / cooling loads (IEA, 2012). Furthermore, these loads represent the largest potential to be minimized, especially, for the countries like Turkey that a portion of heating and cooling relies on fossil fuels. In the case of Turkey, the commercial sector have an energy saving potential of almost 30% in electricity loads and around 20% in fossil fuel usages (ECSSD and ECA, 2011).

## **1.2. Motivation: Existing Past and Demanding Future**

There is no denying to the fact that sustainability accounts as the central issue of new construction practices, however, the growing interest towards sustainable high-performance buildings and new construction are insufficient in solving the problem. Because of several reasons, new buildings are only a part of the solution. Firstly, in comparison to the existing buildings, they constitute only a small percentage of the building stock and are not enough to achieve the sustainability and energy-efficiency goals. Secondly, new constructions require extra land, energy, materials, and financial resources, thus, demolition of aging buildings means the demolition of all these indirect energy sources that are embodied in the existing building. Thereupon, efforts need to be focused on reducing the need for new constructions and, instead, improving their use, or applying retrofit actions should be at the first plan of attentions (Poel et al, 2007).

The building industry is faced with a vast stock of existing buildings that are not sustainable (Jagarajan, Abdullah @ Mohd Asmoni, YM Lee, and Jaafar, 2015). Since, the existing building stock is, mainly, the result of the construction practices under low energy regulations, thus, majority of them have poor condition in terms of physical

problems. The situation is even worse for buildings built before 1970s, when the thermal insulation standards became mandatory (Poel et al, 2007). Because of their poor condition, the existing building industry carries a great potential to minimize its adverse environmental impacts through the effective maintenance, improvement, reuse or adaptation (Gursel, 2010). In other words, maintaining the intended function and performance of these buildings during their lifecycle is the vital action that the existing building industry requires. It is projected that almost 60% of the current building stock will still be in use in 2050 (IEA, 2013). Meanwhile, in facing with the challenge of climate change, the solution should meet the long term requirements. Energy retrofitting of existing buildings account by researchers and professional practitioners as a rational strategy to minimize the environmental effects, especially, in a long timeline of effectiveness (Miller and Buys, 2008; Jagarajan, Abdullah @ Mohd Asmoni, YM Lee & Jaafar, 2015; Ahmed, Mateo-Garcia, Aude, and Norberg, 2017). According to Bollack, over the past twenty years, we witness a redefinition in our attitudes towards the past and the world as it exists. This shift is evident in the increasing number of retrofitting projects that develop existing new architecture by adapting, reusing or energy refurbishment activities (Bollack, 2013, 8). Among the main requirements of existing buildings; minimum fossil fuel usage, minimum electrical load demands, high quality of comfort and safety, and, broadly speaking, improved level of its performance are outstanding. These objectives can be achieved through energy retrofitting of the building. However, the main challenge is the proper implementation of retrofitting strategies regarding the each building's internal organization in admitting energy and comfort improvements (Poel et al, 2007).

### **1.3. Problem Statement**

*Performative vs. prescriptive energy retrofit guidelines:* The building industry has been supply-driven for decades. The traditional prescriptive building regulatory codes, and standards, as currently driven in many developed countries, enforce the traditional requirements of the building industry. For this reason, the building industry has passed its technological development and innovation levels rather low as compared to many

other industries. However, more recently, following the efforts to maintain a customer-oriented building, Performance-Based Building (PBB) approach has attracted the attentions. This approach is recognized as the main stimulant for turning from supply-driven building industry towards a demand-driven industry. The customers have been also changed and are expressing their requirements more precisely than the past. Furthermore, the main challenge of the future building industry either in new constructions or retrofitting existing buildings, will be focusing on end-user needs and requirements. This means that the project drivers need to find a language to explain the performance quality of a building in legible terms to the end-user (Huovila, 2005). In contrast to the traditional construction tenders, who act according to a detailed design with a pre-defined materials and components, the Performance-Based Building approach should perform based on a provisional design alongside performance requirements for those materials and components. Accordingly, the designer needs to initially specify the performative requirements, not the building components. In this situation, the façade retrofit is faced with serious barriers in the selection of performance criteria and the feasibility of the alternative retrofit actions (Sims and Bakens, 2002).

Although the great potential of existing building stock in conserving energy and eliminating CO<sub>2</sub> emissions has been remarked, retrofit guidelines, typically address a set of general propositions that do not cover the specificities of each building. They mainly refer to prescriptive energy and comfort requirements and target technical specifications rather than performance requirements. In other words, their orientation is *towards the means rather than the ends*. In terms of comfort improvements, current retrofit practices are generally based on code defined comfort standards. Studies show that these practices did not lead to the expected high comfort quality in the post occupancy evaluations (Wagner et al. 2007). Furthermore, to minimize the performance gap, in terms of energy consumption and comfort, in addition to the determination of user needs and discomfort sources, a Performance-Based Retrofit Framework (PBRF) should be developed. Performance Based Building aims at using



performance requirements to define a building or building product's fitness for purpose. The application of Performance Based Building principles will provide the basis for a clear communication between all stakeholders involved in the project. In such a situation the respective building codes and standards will also turn towards performance based standards. These benefits stem from a better fitness for use of the building itself, improved communication throughout the retrofit process, and adequate possibilities for innovation in and of the building process (Sims and Bakens, 2002).

*Energy demands vs. comfort in office buildings:* A deeper analysis of the recent literature on the energy retrofit processes revealed that most of these studies and research works do not address any information on the selection of indicators or the performance criteria of the considered retrofit actions. Additionally, majority of the conducted façade retrofit studies do not involve the fact that to what extent the indoor environment of the considered building responds effectively to the applied retrofit actions on its façade system. Providing a comprehensive integration between two key domains of energy efficiency and comfort, mainly, fails through the façade retrofit practices and studies. According to the 2010/31/EU European Directive, establishing high comfort quality entails a substantial amount of energy consumption. In this regard, Intergovernmental Panel on Climate Change (2007) indicates that the office buildings, which consume much energy on ensuring the comfortable indoor environment, carry a substantial potential in eliminating CO<sub>2</sub> emissions. This is because the occupants' comfort and wellbeing have a direct impact on their productivity at work and the loss of productivity means the loss of cost and investment of the organization. Thereupon, the conflict between high comfort and energy efficiency becomes more prominent in office buildings (Roulet, 2001). Accordingly, a firm tie between energy performance and the indoor comfort should be established through the retrofitting process. This thesis addresses the need of establishing tradeoff conflicting measures of energy efficiency and comfort demands thorough the selection of retrofit actions.

*The importance of the Façade:* The most influential building component in terms of energy consumption, is the building façade system. Besides regulating the energy

consumption and indoor environmental quality, building façade illustrates the building character and underlines its existence. From the construction point of view, it is the main component of the building between indoor and outdoor environment, which protects indoor spaces from the external adverse effects. Thermo-hygrometric comfort aspects, which control the heating and cooling demands of buildings are the direct results of heat losses or gains through the façade. Daylight quality, visual, and acoustical comfort, all are parameters that directly depend on the façade performance of buildings (Konstantinou, 2014, p.30).

*Decision support retrofit framework:* In retrofit practices, the consideration of multiple retrofit alternatives can be provided for each type of intervention. The decision maker has to select the proper measures, even a combination of several measures from all available options for the same intervention. The earlier decisions play the most important role in the success or failure of a retrofit project, consequently, they have the biggest impact, although, with less effort during the whole process (Konstantinou, 2014, p.30). Furthermore, there is a need to ease the decision making process by means of an initial but very essential retrofit framework. This thesis proposes this framework by associating comfort issues with energy efficiency measures. The framework identifies a set of suitable retrofit actions for existing office buildings with different interior spatial arrangements. Meanwhile, the proposed framework paves the way of selecting proper retrofit actions.

*The Lack of energy retrofit practices in Turkey:* Despite all the benefits, retrofit projects are still only slowly being implemented in the USA and Europe level. Meanwhile, decision makers, such as building owners, tenants, construction stakeholders, etc. have few resources to value a retrofit. At the Turkish level, retrofit practices do not yet account as established actions, while Turkey is faced with a vast stock of existing office buildings that will need to be retrofitted in the near future.

#### 1.4. Aims and Objectives

This thesis aims at developing an energy retrofit framework indicating applicable retrofit measures on office buildings' façade system to improve both energy efficiency and indoor comfort quality. In this regard, this thesis deals with only the goal of reducing energy consumption through passive actions. In order to achieve a holistic picture of the joint framework for both energy reduction and comfort improvements, the interdependent relationships among building form, façade design, and interior spatial arrangement need to be investigated. Meanwhile, the measures are proposed within a structured framework consist of three sub-frameworks representing three scales: the *building*, the *façade*, and the *room*. Each sub-framework presents a set of viable alternatives for distinct problems that can be used during decision-making in the initial steps of the retrofit process to achieve a general knowledge about different alternatives for each problem. The challenge is in balancing all of these concerns. Some actions are in conflict with each other or some of them have a similar impact. For this purpose, the proposed alternative actions that are categorized in a relationship matrix to realize whether they have same effects, supplemental effects, or contradictory effects. Finally, the recommended actions are classified according to their energy saving potentials in three demanding domains of cooling, heating, and electrical loads.

The proposed framework, which is developed in this research, aims to assist the decision-makers in the initial steps the energy retrofitting process. This framework, by providing a wide view to the applicable façade retrofit actions, helps the decision maker to understand the different alternatives. As mentioned previously, most of the energy saving options and required high levels of indoor comfort are in conflict with each other. In this regard, the proposed framework will help decision maker to choose the best tradeoffs among the different viable actions by indicating these conflicted actions. Briefly, this thesis attempts to (1) identify the current barriers to façade retrofits of existing office buildings, (2) provide the relationship between two main objectives of an energy-efficient façade and comfortable indoor environment, (3) provide a retrofit framework for façade and indoor spatial comfort quality (4) develop a relation matrix

consisting of best tradeoffs among the energy efficiency and comfort, usable by decision makers.

## 1.5. Research Questions

Thereupon, taking into account the need to retrofit office buildings and the importance of implementing performance-based façade retrofit actions, this thesis aims at answering the following main question.

*How can the passive energy improvement actions be integrated with different indoor environments through the façade retrofitting of existing office buildings, in order to support decision-making?*

To be able to answer the research question, several sub-questions need to be investigated, as indicated below:

1. What are the energy use profiles of existing office building stock in the USA, Europe, and Turkey?
2. What is the roadmap and barriers of an energy retrofit process?
3. Who are the decision makers of a retrofit process and what type of information do retrofit stakeholders find useful to support the decision-making?
4. Which façade –dependent pre-defined parameters of existing buildings play key role in energy performance of the building?
5. What are the spatial comfort demands in different office environments?
6. How can the impact area of passive retrofit actions be defined in different indoor spatial arrangements of different office buildings?
7. How can the different energy efficiency and comfort improvement measures be organized?

## **1.6. Scope of the Thesis**

This thesis develops the framework for current and future retrofit practices. In the context of Turkey, this thesis has put its climatic concerns on one of the most critical climatic zone of Turkey in terms of both population and future energy demands, which is the Central Anatolian region. This region has known as mixed-dry climatic zone. Nevertheless, the applied methodology in developing the framework does not exclude its applicability in other geographical areas with different climates. The special focus of this thesis is the exploration of passive façade retrofit solutions.

## **1.7. Thesis Methodology**

To answer the research question and to provide the tradeoff between energy demands and comfort quality, this thesis presents a framework to support decision making process in the early steps of the façade retrofit projects. The methodology used in structuring the framework consists of several steps, as represented below:

- a. An extensive literature survey on energy retrofit process, essential steps, involved stakeholders and decision makers, the urgency of office building retrofitting, the façade role in the performance quality of the building, how the performance requirements are met, especially in relation to energy efficiency and indoor comfort, and the particular comfort requirements of different office environments in terms of their interior spatial arrangements.
- b. The development of an energy retrofit roadmap and indication of key decision making sections and in which step, decision makers need the proposed framework.
- c. Extraction of passive retrofit actions and systematically organization of different retrofit actions effective on both energy performance and comfort quality.
- d. Generating a façade retrofit framework and a spatial comfort sub-framework
- e. The development of a relation matrix consists of best tradeoffs among the energy efficiency and comfort, usable by decision makers

The organization of the different actions compiles a “Façade Retrofit Framework”, from which the retrofit decision-maker chooses the actions to use to improve the façade performance. To develop the framework, a systematic approach was adopted to identify the actions, their different indicators, and performance criteria. The presented framework consists more than 100 actions, which are named in the framework as *performances*. These performances although are different but mostly complementary and in a few cases are in conflict with each other. The relations of these different performances are illustrated in a relation matrix.

## **1.8. Thesis Structure**

The structure of this thesis follows the six steps, which is illustrated in Figure 1.4. The first chapter begins with a brief introduction followed by motivation to the study, problem statement, aims and objectives, research questions, scope of the thesis, and thesis methodology. The second and third chapters cover an extensive theoretical knowledge on the field with an essential effort in connecting achievable energy efficiency and high quality comfort. Respectively, chapter four represents the developed façade retrofit framework as the output of the research. Chapter five gives the required guidelines to use the proposed framework. Finally, chapter six comprises the conclusion of this thesis, limitations, and the recommendations to the future researches.

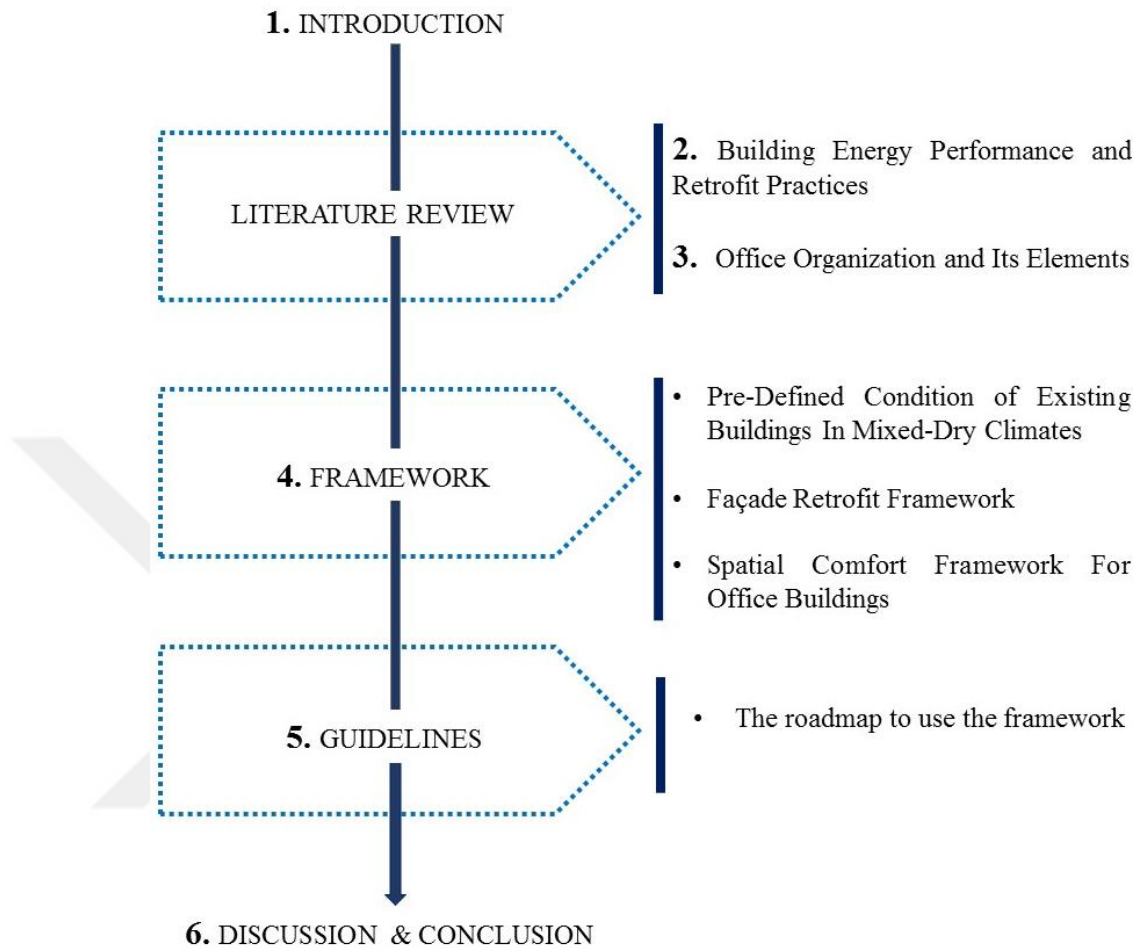

**Figure 1.4.** Thesis structure.





## **CHAPTER 2**

### **2. BUILDING ENERGY PERFORMANCE AND RETROFIT PRACTICES**

The field of energy retrofitting of office buildings has been investigated in a wide variety of research, which have been allocated to discuss various dimensions of energy retrofitting aspects in terms of technical, financial or social considerations. The focus point of this thesis is mainly the technical considerations of energy retrofitting projects. Technical considerations in current study are attributed to improving energy performance and comfort in the existing office buildings as the subset of commercial buildings. This chapter presents the literature survey on building retrofit, beginning with the existing energy retrofit practices and the main steps of its process.

Recently, the construction industry turned its emphasis mostly on the vast existing building stock with the necessity of retrofit and refurbishment projects. As shown in Figure 2.1, new construction projects in the USA are only a minor part of the whole building stock. For instance, in 2008, new commercial construction of the USA, covers only 1.8% of the entire building floor area. The economic crisis in 2007 has not reduced the energy demand of buildings, but it affected and increased the awareness towards the necessity of enhancing energy performance of existing buildings (McGraw-Hill Construction, 2010).

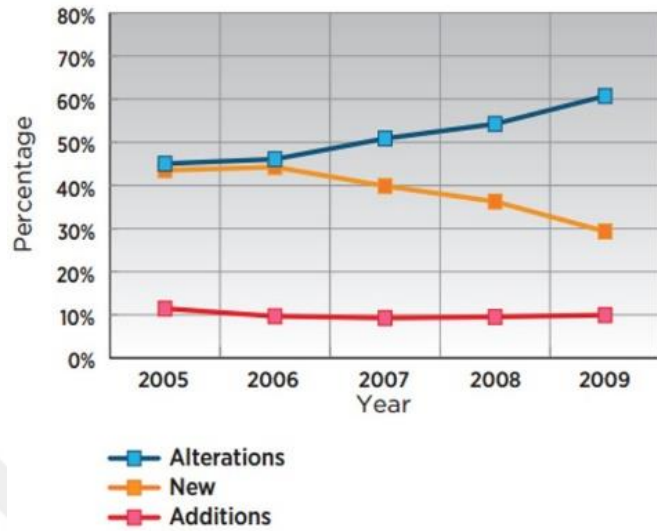

**Figure 2.1.** Commercial construction (McGraw-Hill Construction, Construction, 2010, p.6).

## 2.1. Commercial Building Composition and Energy Use by Sector

Commercial Buildings Energy Consumption Survey (CBECS) database, which is a national sample compiled by the U.S. Department of Energy, defines commercial buildings as all buildings that at least half of their floor-space is allocated to non-residential, non-industrial, and non-agriculture functions. Commercial building types can be classified based on several factors including the number of projects, floor space, and their energy demand. In the USA, the major share of floor space is allocated to office buildings with 17% and respectively to retail (16%), education (14%), and warehouse projects. In terms of building numbers, the largest group of projects also is comprised of office (17%), retail (14%), service (13%) and warehouses (12%) buildings. Accordingly, office building category has the highest energy consumption with almost 19%. Respectively, retail (18%) and education (11%) are the highest energy consumers after office buildings (McGraw-Hill Construction, 2010).

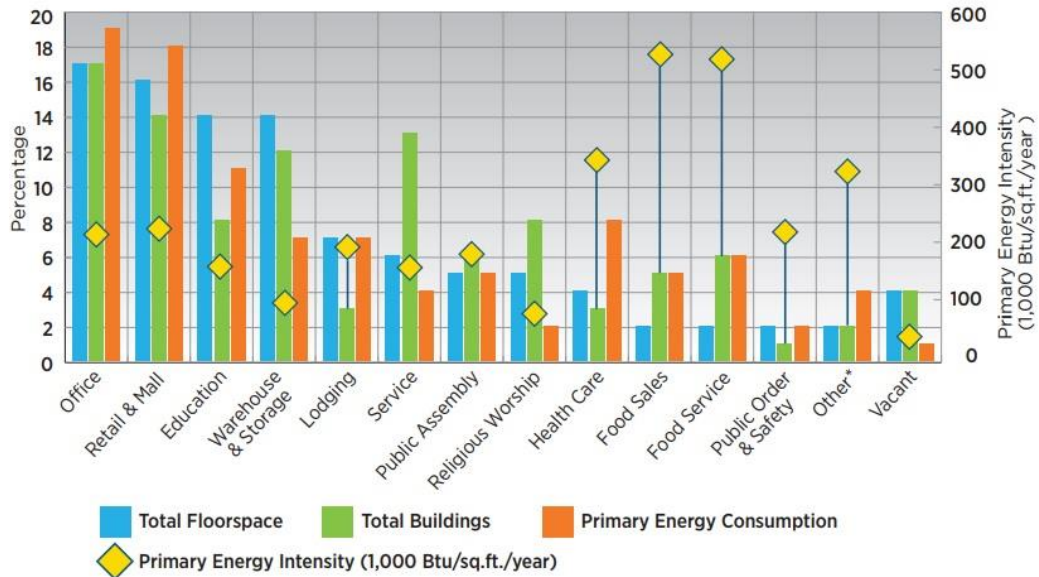

**Figure 2.2.** Commercial building types and energy consumption (McGraw-Hill Construction, 2010, p.10).

## 2.2. Profiles of Building Industry Energy Use in the USA

Electricity is the main energy source of buildings in U.S. The increased construction activities have led to a considerable growth in the electricity demands. Natural gas stands in the second main energy source and respectively, the third degree attributes to petroleum (primarily heating oil). Indeed, the vast electricity demand of buildings was the principal accelerator to the electricity generation growth between years of 1985 and 2006.

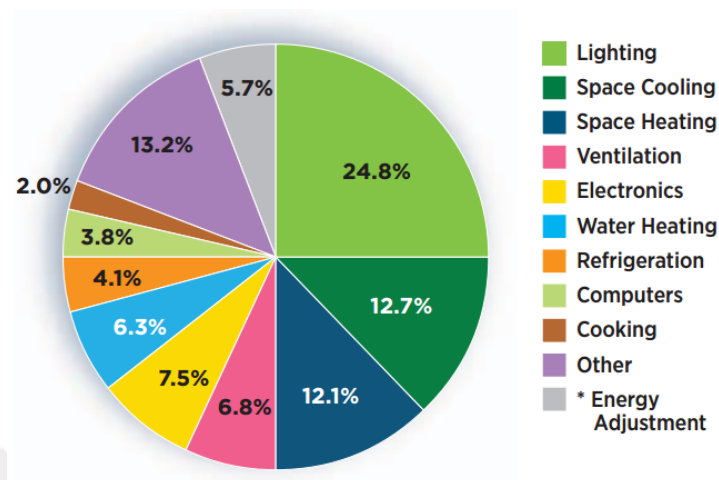

**Figure 2.3.** Commercial primary energy end-use (McGraw-Hill Construction, Construction, 2010, p.16).

As seen in Figure 2.3, the major energy end-use in commercial buildings attributes to the lighting systems, which cover 24.8% (almost one-fourth) of a building's total energy use. Respectively, cooling systems with 12.7% and heating systems with 12.1% account as the energy consumer systems in commercial buildings (McGraw-Hill Construction, Construction, 2010, p.10). The building industry is responsible for high energy consumption and its global demand is expected to grow in the future. Between 2010 and 2050, global heating and cooling needs are expected to increase by 84% in commercial buildings and by 79% in residential buildings and the major number of buildings of the 2050s are buildings that already exist. (Ürge-Vorsatz et al., 2015). Energy efficiency measures are therefore crucial to reduce Green House Gas emissions of the building sector.

### **2.3. Contemporary Retrofit Practices**

Numerous global alliances of institutions have synthesized the retrofitting of existing buildings in their agendas. International energy programs are implemented by these institutes. The International Energy Agency (IEA), established in 1974 within the

framework of the Organization for Economic Co-Operation and Development (OECD), is one of the outstanding institutes. They aim to maintain an international co-operation among 28 countries, which are practicing IEA. The main topics of their research include research for improving energy security in development of energy efficient technologies and renewable energy resources (Hagentoft, 2017). For instance, the *Holistic Assessment Took-Kit on Energy Efficient Retrofit Measures for Government Buildings* (EnERGO or *Annex 46*) is one of the IEA's programs developed for nonresidential governmental buildings in 2004 by the co-operation of the OECD and the IEA with the main topic of sustainability in existing buildings. Participating countries in EnERGO are: Canada, Denmark, Finland, France, Germany, Italy, Russia and United States (Fraunhofer Institute for Building Physics, 2011). The Energy in Buildings and Communities (EBC) program is another example of energy related programs of IEA to foster the integration process of energy efficient technologies within existing buildings and improving their performance. Turkey is included as one of the participated countries in these programs (Hagentoft, 2017).

### **2.3.1. Retrofit practices in the USA**

With the introduction of Energy Star program, the 1990s witnessed one of the first market transformations towards energy-efficient buildings. Energy Star was used as a tool of evaluating energy consumption in existing buildings. A decade later, another new program namely, "Leadership in Energy and Environmental Design for Existing Buildings, Operation and Maintenance (LEED-EBOM) appealed the green buildings market attention. The launch date of the program was in 2007 (Yudelson, 2009, xi-xvii). The *Building Technologies Program* as a particular approach to existing buildings' retrofits, belongs to the US Department of Energy. This program seeks out the energy saving potential in buildings, especially, in the envelope system and proposing advanced engineering solutions. Regarding the envelope systems, this tool focuses on walls, roofs, foundations, windows, and doors (U.S. Department of Energy, 2010). In 2002, Architecture 2030 as an independent organization, introduced a plan to reduce fossil fuel energy uses by 2030. They claimed that this goal will be not achieved

until existing old and poor performance buildings undergo the energy retrofitting plans (Architecture 2030, 2013b)

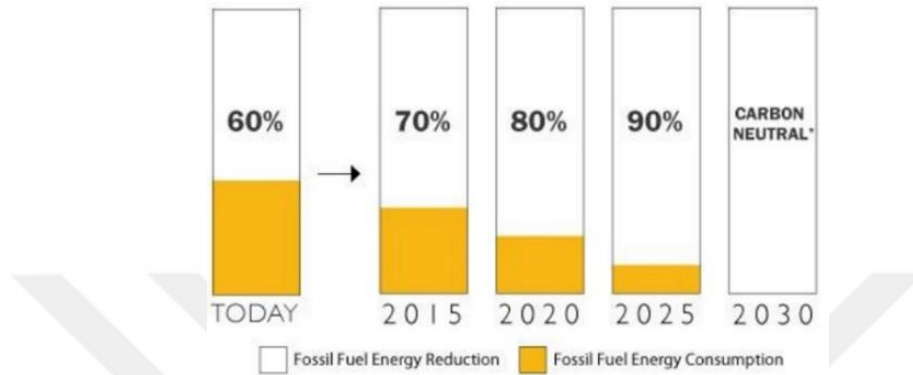

**Figure 2.4.** The 2030 challenge (Architecture 2030, 2013b).

In 2010, the U.S. Environmental Protection Agency declared that all new and existing federal buildings have to comply with energy performance standards of the Architecture 2030 challenge (Burnham 2009). Under the umbrella of the Clinton Climate Initiative (CCI), the *Energy Efficiency Building Retrofit Program* (EEBRP) was launched in 2007. The CCI aims to ease the implementation of retrofit projects to overcome the market barriers. Since 2007, above 250 retrofit projects have been either studies or completed (Clinton Climatic Initiative. 2009). Briefly, over the last decades, numerous organizations have launched and introduced programs regarding the retrofit plans and actions in the U.S. Besides the mentioned programs, more recent ones are: the Zero Net Energy Initiative for commercial buildings (2007), and the Los Angeles Retrofit Ordinance for City buildings (2009).

### **2.3.2. Profiles of building industry energy use in Turkey**

Turkey's energy depends on oil and natural gas. In 2007, Turkey imported 58 million tons of oil equivalent natural gas and oil, which proves its dependency on imported energy sources of around 72%. This amount increased up to 74% in 2014 (Sarı, 2014).

Turkey's energy demand will reach up to 222 million tons of equivalent oil in 2020. Accordingly, Turkey has not self-sufficient energy sources and its dependency on imported energy sources and energy costs are increasing year by year. In 2014, the building sector was responsible for 33% of the total energy consumption of the country. Approximately, 31% of this amount was used for cooling and heating purposes in buildings (Bayülken, Kütükoğlu, 2009). On the other hand, studies show that 35% of the existing buildings stock in Turkey has the potential to be energy efficient buildings (Bayram, 2009). Turkey's energy saving potential is estimated more than 30% by application of insulation in buildings (EIE, 2004). In 2008, the amount of savings reached by TS 825 insulation regulations, were around 4.7 billion dollars, which shows the vital and significant role of the heat insulation in the country's economy (Kanan, 2013). Based on the discussed facts, energy retrofitting of existing buildings in Turkey is an inevitable matter (Ashrafian, Yilmaz, Corgnati, and Moazzen, 2016). In this situation, increasing energy efficiency and the use of renewable energy sources are the two main actions, which can be implemented to overcome both energy costs and fossil fuel dependency. Compared to the renewable energy implementations, applying energy efficiency measures and upgrading building performance stand as the simplest and cheapest options (Ministry of Energy 2007).

#### **2.3.2.1. Turkey's building energy regulation**

Almost one third of the consumed energy amount in Turkey is used for heating and cooling. 90 % of the buildings in Turkey suffer from insufficient heat insulation (Energypedia, 2016). For this reason, the focus area of Turkey's building energy regulation is on thermal resistance factor. The National Standard of Thermal Insulation Requirements for Buildings (TS 825), indicates the building's thermal insulation requirements. TS 825 first issued in 1999 and became mandatory in 2000. TS 825 as a mandatory national building energy regulation determines required minimum U-values for envelope system elements. In other words, TS 825 only regulates thermal insulation requirements. In retrofitting an existing commercial building, if the retrofit actions affect at least 15 percent of the aggregate area, TS 825 codes require the building

compliance with the latest version of the regulation (GBPN, 2013). In February 2007, Energy Efficiency Law came into force, which obliged industry, transportation, and residential sectors to implement energy improvement measures. More recently, Turkey tries to adapt its energy regulations in accordance with the European legislation on buildings. Building Energy Performance (BEP) is one of the adopted regulations that contemplates the utilization of district heating and / or renewable energy in buildings (GBPN, 2013). Turkey energy efficiency regulations have not yet comprised of elaborated national energy consumption survey databases like CBECS in the USA and the only published energy resource labels and efficiency regulations in Turkey, was printed on 2007 official gazette. Nevertheless, the related research in this regard have been published such as BEP-TR, BEP-HY, ENVER database and TÜİK data related energy consuming (Taşpınar, Çelebi, & Tutkun, 2013).

### **ENVER portal database**

The Ministry of Energy and Natural Resources (MENR) of Turkey has developed ENVER database, which as an energy efficiency database, elaborates energy consumption in accordance with energy regulations. Legally, buildings and companies regarding their floor-space area and annual energy consumption per TPE (ton equivalent petrol) are supposed to register in ENVER portal, fill the energy data form, and as final step should enter their energy usage information. The mentioned companies can be classified into Industrial buildings, public buildings, and private buildings, which have their specific regulations and requirements from the portal (Anon, 2016).

### **B. BEP-HY and BEP-TR**

BEP-TR (Regulation of Energy Performance of Buildings) is an internet-based software to calculate the building energy performance, which was developed by the Ministry of Public Works and Settlement of Turkey. BEP-HY (Building Energy Performance-Calculation Method) is used as a road map to extract data related to annual energy consumption amounts/per space area (m<sup>2</sup>) and also the amounts of CO<sub>2</sub>



emissions of a building consistent with BEP regulations. It is possible to enter the related information like, building geometry, heating, lighting, ventilation, and mechanical data into the program. It can be determined the amount of demanded energy by the building and in accordance with EU norms via the program. The final energy performance evaluation data and energy card of the building become released according to the results of BEP-HY (Kabak, Köse, Kırılmaz & Burmaoğlu, 2014).

### **2.3.2.2. Retrofit practices in Turkey**

Although retrofit practices are not uncommon, however, compared to the USA and Europe, is placed at very low levels (Yigitcanlar, 2016, p.125). Indeed, there is a wide academic researches and studies in the field of energy retrofitting of existing buildings in Turkey, however, in practical level, the efforts are not substantial. At the academic level, the researchers, mainly, attempt to investigate the feasibility of the different energy retrofit strategies regarding two main objectives of energy and cost efficiency (Mangan and Koçlar Oral, 2016; Ashrafian, Yılmaz, Corgnati, and Moazzen, 2016; Sağlam, Yılmaz, Becchio, and Corgnati, 2017).

## **2.4. Building Energy Retrofitting: Definition**

In a situation that different regions have defined different expressions for the retrofitting of existing buildings, extracting a standard definition of retrofit neither at a regional or international level seems difficult. Accordingly, obtaining a comprehensive definition of an energy retrofitting is seen as a fundamental first step for this research. As Douglas (2006:1) states, “in the world of building the terms rehabilitation, conversion, remodeling, restoration, reinstatement, and so forth are unhappily confused.” Both authors and contractors that are acting in these projects by taking into account the level and the scale of the interventions, the conserved amount of energy and CO<sub>2</sub> emissions, and the time span of the activities use the mentioned terms interchangeably. An intervention action is defined in Oxford English Dictionary as “a concept that involves standards/norms regarding entering a situation to change its consolidation, repair and reshaping of structural course or resolve it and/or non-

structural elements”. As mentioned, there are various types of applicable interventions in existing buildings to improve their performance. Depending on the building’s construction year and its sensitivity in terms of conservation values, improvement interventions can vary. Some of the most important actions are mentioned in *Refurbishment Manual* by Giebeler (2005), which are renovation, conversion, recycling, reconstruction, restoration, repair, and refurbishment. The following table, illustrates the related definition of each action:

**Table 2.1.** Definition of intervention activities (Giebeler, 2005).

<b>Strategies</b>	<b>Definition</b>
Conversion	Bringing a new life to the building with a different function
Recycling	Applying a new function to a historical building
Reconstruction	Rebuilding a structure that no longer exists and no parts of the original building remain
Restoration	Finishing an incomplete structure and reproducing the original materials
Renovation	Bringing a new life to the building with its original function
Repair	Replacing or repairing the defective building components
Refurbishment	Implying an improvement process by cleaning, decorating, and re-equipping. It may include retrofitting process. The load bearing structure and interior layouts are not included in intervention process.
Retrofit	Refers to the upgrades in existing buildings that can be either fixing and repairing insufficiencies in the building performance, or complying with required standards.

According to the definitions, two terms of reconstruction and restoration covers a series of interventions, which do not carry any performance improvement plan, but rather, aim the reconstitution of the original building. Conversions, typically, target the structural elements of the building. The retrofit and refurbishment terms are often used

interchangeably. However, they have different meanings. The refurbishment is one of the more suitable synonyms to describe building retrofit, which “include intact but, for example, outdated components or surfaces”. Refurbishment contrasts with conversion because “refurbishment does not involve any major changes to the load bearing structure or interior layout”, which could be possible in whole building’s conversion (Giebeler, 2005, pp.13-14).

According to the Oxford English Dictionary, retrofit is “to provide (something) with a component or feature not fitted during manufacture; to add (a component or feature) to something that did not have it when first constructed.” Based on the Cambridge Dictionary, retrofitting is “to provide a machine with a part, or a place with equipment, that it did not originally have when it was built” (Cambridge Dictionary, 2016). In buildings, retrofit refers to updates in existing buildings that can be made either to fix and repair insufficiencies in the building performance or to comply with current standards. The particular type of the retrofit for a building depends on the target of intervention. Several types of retrofit can be categorized as structural, energy, fire resistance, aesthetic, blast, and etc. (Giebeler, 2005). Furthermore, energy retrofits would refer to improvements done to a building with the purpose of reducing energy consumption and CO<sub>2</sub> emissions level and achieving a better energy performance, in accordance with new energy standards (Dixon and Eames, 2013).

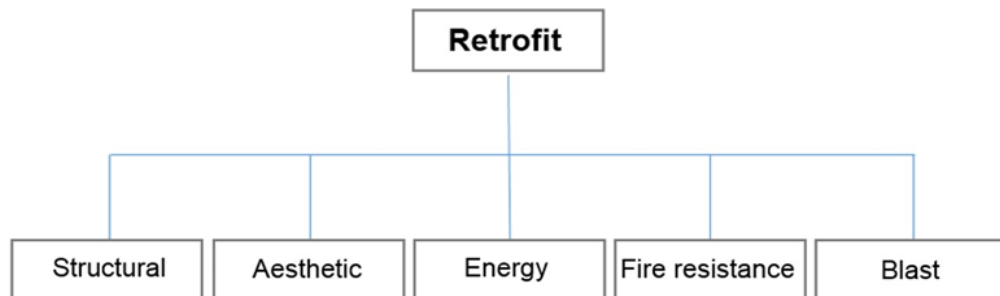

**Figure 2.5.** Various types of retrofit actions (Giebeler, 2005).

In the reviewed literature, energy retrofitting is denoted as a complex form of the refurbishment activity (Bernier et al., 2010). However, regarding the scale of interventions, the boundaries of “renovation” and “retrofit” have been distinguished clearly in other research works. In the case of commercial buildings retrofitting projects, Dixon et al. (2014) denote retrofit actions mainly as lighting upgrades and small interventions that can be carried out while occupants are still using the facility. While refurbishment is indicated as more deep alterations or improvements of the both exterior and interior characteristics of the building.

Depending on the purpose of retrofit actions and regarding the age of the existing building, specific life spans are defined. According to National Park Service report, the historical value of the buildings is estimated when the building has reached 50 years (National Park Service, 2013). Historical considerations give a patrimonial (cultural or historical) value to buildings. Thus, energy retrofitting of historical buildings will require the involvement of the aesthetic, cultural, or historical concerns, which is beyond the scope of this thesis. By taking this fact into account, this study investigates retrofit actions for non-historical buildings, which have not reached the fiftieth year of their life, therefore, are not covered neither as historical buildings category, nor as heritage buildings domain. Regarding the mentioned influential factors, such as, type and existing condition of the building, funding source and technological means, users’ will, and motivation, which all are effective in a completing a successful energy retrofit projects, scholars have defined a distinct set of energy efficient retrofit measures (Weiss et al., 2012; Wilson et al., 2014). These measures mostly are applied to enhance the envelope system of the building, replacing or changing HVAC system, spatial organization, and upgrading appliances and fixtures. Considering a building as a system of systems is another point of view that helps recognize life times of different parts of that building (Giebeler, 2005, p.23). In this way, it becomes possible to identify which part of the building needs the first and urgent retrofit intervention. According to the lifetime table, the façade failures appear after 20 years.

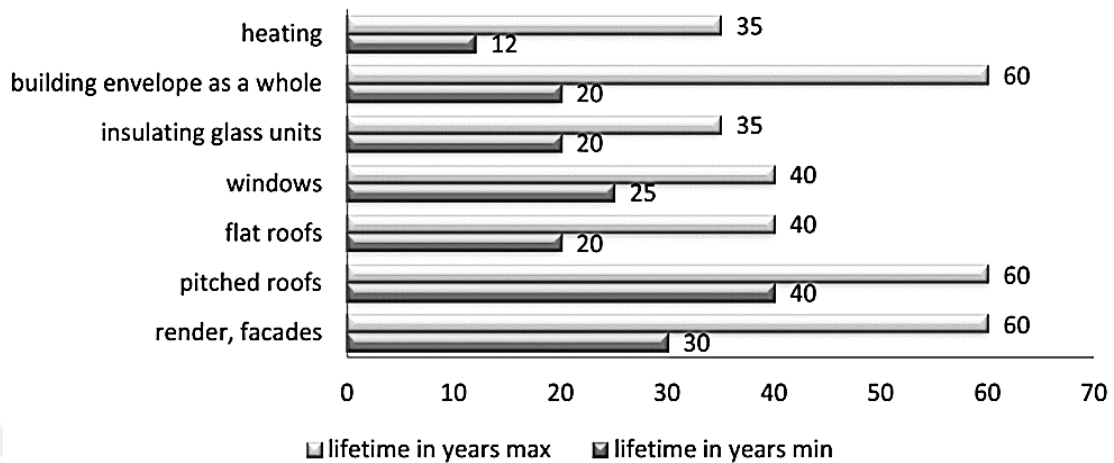

**Figure 2.6.** Life span of building systems (Giebeler, 2005).

#### **2.4.1. Building energy retrofitting: application levels**

As Giebeler (2005) declares, different interventions in terms of scale and purpose require different types of retrofit actions. Regarding the scale of the project, it can vary from partial repair works to a total retrofit action. According to Rajapaksha et al. (2013), energy retrofitting can be applied within three possible levels of minor retrofit, intermediate retrofit, and major retrofit. Applying interventions without targeting the architectural character or appearance of the building are identified by Rey (2004) as minor retrofit or stabilization actions. Considering simple interventions as quick and easy solution sets that can produce immediate benefits, like adding insulation or upgrading lighting systems are also allocated to minor set of actions (PCA and Arup, 2009). Rey (2004), denotes intermediate retrofit as substitution strategy that is along with applying considerable transformations to elements, components, or substance of the building and can be applied with minimum disruption to building occupants. Improving energy efficiency of an equipment or energy-related components that simultaneously modifies the appearance of the building, like replacing window glazing and doors, updating inefficient heating and cooling systems are also known as intermediate retrofit (PCA and Arup, 2009). In a situation that a significant or complete

transformation of the building’s envelope, heating, ventilation, air-conditioning and lighting systems (upon to the age and typology of the building) have been involved, but a large portion of the original substance of the building is preserved, a major retrofit (deep or restitution) action has been carried out (Rajapaksha et al., 2013, p.85). Adding, replacing or rearranging the roof, windows and air-conditioning systems with renewable energy sources and plants are also fitted in the major category, which are highly disruptive to building’s occupants.

**Table 2.2.** Different application scales of energy retrofitting (based on Rey, 2004; PCA & Arup, 2009; and Rajapaksha et al., 2013).

Retrofit application levels		
Minor	Intermediate	Major
<ul style="list-style-type: none"> <li>• Stabilization actions</li> <li>• Unmodified appearance</li> <li>• e.g. adding insulation, changing lighting system</li> </ul>	<ul style="list-style-type: none"> <li>• Substitution action</li> <li>• Modified components &amp; appearance</li> <li>• e.g. replacing window glazing, updating HVAC</li> </ul>	<ul style="list-style-type: none"> <li>• Complete envelope transformation + preserved original building substance</li> <li>• Highly disruptive to occupants</li> <li>• e.g. roof upgrading &amp; renewable energy plants</li> </ul>

In the case of retrofitting office buildings, the intervention on the existing façade is mainly significant, which needs to work on the technical installations (Rey, 2004). With an emphasis on façade interventions, Rey (2004) proposes three main types of façade retrofit actions: ‘the stabilization strategy (STA)’, ‘the substitution strategy (SUB)’ and ‘the double-skin façade strategy (DSF)’. He describes STA as an action that consists of a set of incremental interventions without fundamental modifying either the substance or the appearance of the building. SUB action is introduced as a strategy,

which carries a complete change of certain elements and transforms simultaneously the substance and the appearance of the building. However, the DSF strategy consists of partially stabilizing the original façade and adding a high glass skin (Rey, 2004).

**Table 2.3.** Different application scales of façade energy retrofitting (Rey, 2004).

Façade retrofit application levels		
STA	SUB	DSF
<ul style="list-style-type: none"> <li>• Stabilization strategy</li> <li>• Incremental interventions</li> <li>• Unmodified substance or building appearance</li> </ul>	<ul style="list-style-type: none"> <li>• Substitution strategy</li> <li>• Complete change of certain elements</li> <li>• Modified substance and building appearance</li> </ul>	<ul style="list-style-type: none"> <li>• double-skin façade strategy</li> <li>• Original façade partially stabilized + adding a high glass skin</li> </ul>

#### 2.4.2. Energy retrofitting challenges and barriers

There is a considerable market demand for sustainable buildings in the U.S, however, building energy retrofit projects are not yet widespread. The annual rate of retrofitted commercial building sector is around 2.2 % (Olygyay and Seluto, 2010). Numerous factors are involved in this situation such as, the lack of information about the building and its systems after the design phase, long lasted payback period, and overestimation of savings (Bosch et al., 2003). Feasibility of a retrofit project in reality depends on the investment return in an expected period of time, which can be influenced adversely by tough economic periods. Additionally, in the case of energy retrofitting, which focuses only on energy, the payback period will be insufficient for a return of the investment. The other constraint is related to the existing building's preconditions and its diagnosis

that are predefined like, existing morphology, materiality, orientation, and building's size (Menassa et al., 2012; Scofield, 2009).

## **2.5. Energy Retrofitting of Commercial Office Buildings**

Office buildings like every construction, are at risk of physical and functional obsolescence. After a certain time, minor maintenance will be inadequate to slow down the process and serious retrofitting interventions must be applied. As mentioned, different elements of a building have their specific lifespans and require various intervention plans. These particular life durations for an office building range from a few months; for interior fittings; to over 30 years for facade components. Generally, the life span of facade elements, which is around 25-30 years determines the longevity of retrofitting cycle of the building. In order to adapt the existing building's state to new standards; in terms of physical, functional and energy efficiency, it is necessary to use the idea of a retrofitting strategy. This strategy can be framed as a full compatibility of the interventions specified by architecturally and technically optimized attitudes (Rey, 2004).

Indeed, designing the buildings with limited life spans began since the Modern Movement's space and construction broke with the past. The building stock of the late half of the 20<sup>th</sup> century was designed to have confined lifespan, to be adapted, absorb change, and detach the different component systems each with their own life cycle (Stratton, 1997, p.87). The other lifespan definition of building components is attributed to Duffy's classification. According to the flexibility of each component in adjusting to the changing needs of users, Duffy and Powell (1997) divided office environment into main components of 'Shell', 'Services', 'Scenery', and 'Settings' (Figure 2.7). Duffy, Cave and Worthington (1976, pp.8-14), define shell as the building's structure and envelope, which have the longest lifespan, almost, 70 years. Lighting fittings, telephone and internet cables, power systems, and suspended ceiling and floors are in the building services category, which can be adjusted due to the user



demands and, approximately, last for 15 years. The spatial organizational changes in response to the occupants' requirements are related to the scenery category, such as partitions and dividing screens that can last for 5-7 years. Settings include office desks and workstations, which have the change capability of day to day.

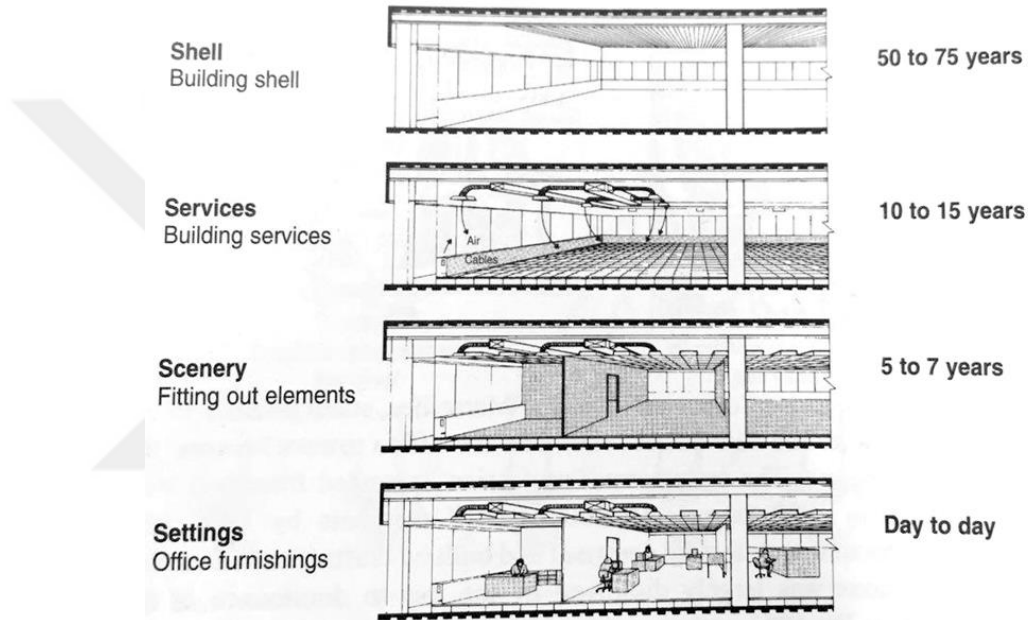

**Figure 2.7.** Office environment components and their lifespans (Stratton, 1997, p.88).

Multiple parameters are involved in office buildings' retrofitting strategies. Numerous research in order to develop this process have presented multi-criteria assessment methodology. In a research by Rey (2004), this multi-criteria methodology focuses simultaneously on three main criteria of sustainability: Environmental, sociocultural and economic. The researcher explores a global optimization of existing buildings based on multiple comparisons between different viable variants, which are applied to different case studies. The results of research confirm the hypothesis that various classification of retrofitting strategies must be framed according to the time of the

building and criteria weights (Rajapaksha et al., 2013). Increasing greenhouse gas emissions as a direct result of climate change effects, combined with the demand for more comfortable indoor environments in office buildings, have made a growing concern related to the rising energy consumption of existing commercial buildings. A large portion of existing office buildings in major cities of the world are over 20 years old, which recall the necessity of the retrofitting strategies for commercial building stock (Rey, 2004). Seeking out the unrealized potential of existing commercial buildings for improving energy efficiency is the most substantial action of this stock to reduce carbon dioxide emissions and non-renewable energy consumptions, on one hand, and an improved indoor environmental quality on the other (Rajapaksha et al., 2013, p.61).

## **2.6. Main Building Stakeholders and Their Roles in Energy Retrofitting**

In the case of existing buildings, eliminating the energy consumption can be gained through maintenance of the building, consistently, or applying different levels of energy retrofit actions (minor, moderate, major), as mentioned previously. Briefly, maintenance refers to applying short-term solutions to the larger problem of an existing building related to energy use and carbon footprint reduction (Poel et al., 2007). From the very beginning steps of the decision making process on whether a building needs energy retrofit actions, the confirmation of building stakeholders is necessary. As regard the fact that some stakeholders are not familiar with the complex process of energy retrofitting, a decision-making framework is vital to arrange their requirements and determine the best engineering strategies in terms of energy efficiency and comfort purposes (Klotz and Horman, 2010). The stakeholders in this thesis are referred to the people, who have a direct or indirect relation in building's operation, and consequences of the retrofitted building. Building stakeholders can listed as: owner, tenants, investors, building operator, and the designers. Every group of these stakeholders has varying and mostly conflicting perspectives throughout the whole steps of the process (Bernstein and Russo, 2009; Yudelson, 2010). For instance, the owner wants to minimize lifecycle expanses, tenant tends to improve employee productivity or user

comfort. The mentioned conflicts may arise when the owner believes that the improvement costs for building should be partly paid by the tenants, who are benefited from the reduced costs of the energy consumption (Fuerst and McAllister, 2011; Poel et al., 2007). Energy retrofit decision are mostly concentrated on maximizing energy savings and reducing pay-back period. However, in some cases, the increased pay-back period, makes investors undesired to continue the project (Azar and Menassa, 2012). In the other words, motivation of the stakeholder to carry out a retrofit project plays an important role. These types of projects, require a comprehensive planning and communication with different stakeholders to align their requirements and gain an optimal solution for all. Alignment of conflicted perspectives of the stakeholders regarding how and why a building needs to be retrofitted eases the selecting act of the best retrofit solutions (Menassa, and Baer, 2014). In the reviewed literature, four main motivation domains or retrofit goal drivers, which stimulate stakeholders to retrofit energy performance of an existing building, have been identified (Menassa, and Baer, 2014). Theses domains are: social, environmental, economic, and technical. Social concerns contain community impacts, human rights, artistic expression, and etc. Environmental factors refer to minimizing environmental impacts of the actions. Economic factors affect financial performance such as sales, profit, labor cost, etc. Finally, technical concerns include building façade retrofit, mechanical system upgrading, electrical system, and plumbing system retrofit. Menassa, and Baer (2014) investigated 30 potential stakeholders' requirements regarding all of these domains and represented the importance rate of each domain. Among them, reducing energy costs set in the first and main requirements of stakeholders. Then, respectively, comply with policy legislation, increasing energy efficiency, improving occupant productivity, and improving occupant comfort were assigned by participant stakeholders as the major concern areas in a retrofit process. It proves the fact that building stakeholders also believe that the desired energy retrofit outcomes can be achieved by using less energy, as energy conservation accounted as the key to energy security and relieving the negative impacts of global warming (EIA, 2012; Yudelson, 2010). Among the mentioned domains, the main target of the proposed retrofit framework in this thesis,

covers some parts of technical (mechanical system retrofits, façade retrofits, electrical system retrofits, and plumbing system retrofits) and environmental domains. The importance rate for each of these items varies from one building to another, thus, they cannot be listed in a priority order. However, regarding the aim of this study, which investigates passive solutions for facade energy retrofitting, the priority option from the four technical actions includes only the ‘building façade retrofits’ (Table 2.4).

**Table 2.4.** Concern areas of the thesis in developing the retrofit framework (by the author).

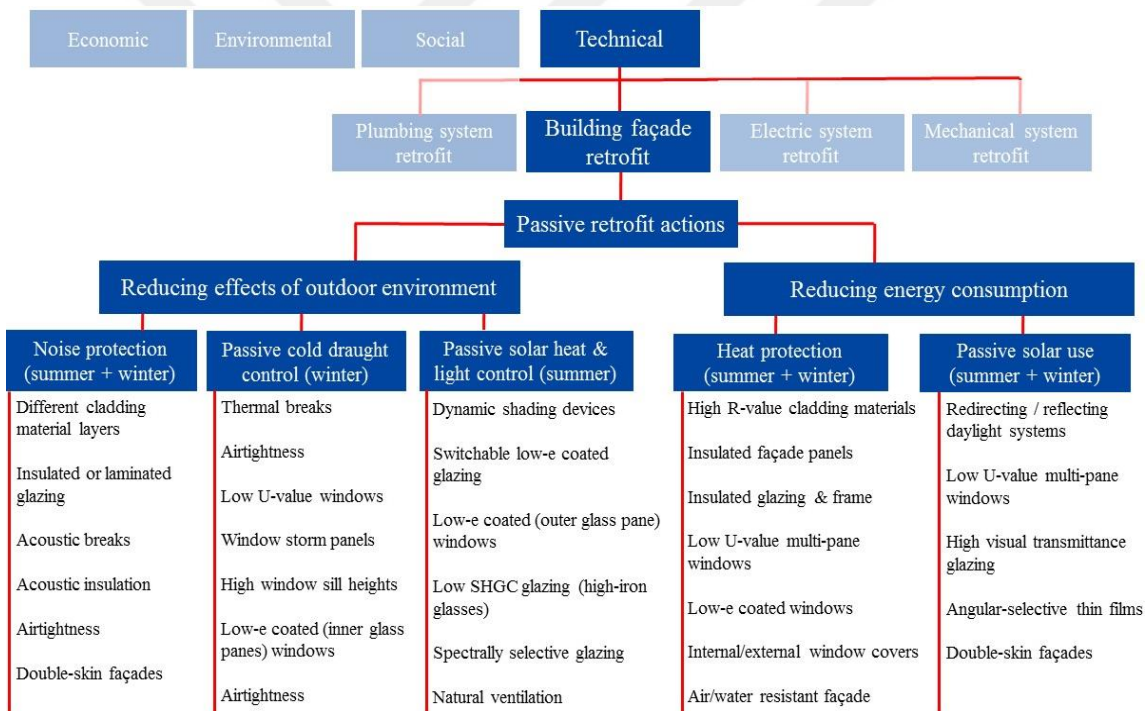

## 2.7. Roadmap Development for Energy Retrofits

The surveyed literature revealed that every performance retrofit process to achieve the considered goals, requires a proper identification on selecting the best retrofit alternatives. For this purpose, a systematic retrofit approach should be applied (Flourentzou and Roulet, 2002; Ma et al, 2012; Jafari and Valentin, 2015; Szalay, Kiss,

Gelesz, and Reith, 2015; Jafari and Valentin, 2017). Based on a systematic approach, Flourentzou and Roulet (2002) describe their method in frame of a multi-criteria analysis, which helps decision maker in drawing retrofit scenarios. Their approach include several steps and follows an iterative process. Cost calculation process, running an energy balance, and checking the coherence between actions are performed through a decision-aiding computer tool called 'TOBUS'. Ma et al (2012) represent five stages for a retrofitting process, respectively: 1) project setup and pre-retrofit survey, 2) energy auditing and performance assessment, 3) identification of retrofit options, 4) site implementation and commissioning, and 5) validation and verification. The other systematic approach is proposed by Jafari and Valentin (2015). Their retrofit process is identified within four hierarchical steps, respectively: 1) measuring energy performance of the building, 2) determining the energy retrofit alternatives, 3) establishing the relationship between investment for retrofitting and energy performance, and 4) formulating an optimization model to allocate the retrofit investments. Szalay, Kiss, Gelesz, and Reith (2015) developed a systemic retrofitting methodology for public buildings and districts. They evaluated the proposed retrofit actions in terms of financial, technical, and legal aspects through a SWOT analysis. The seven steps of their approach are: 1) defining building characteristics, 2) defining requirements /standards, 3) identifying the relevant technical retrofitting gaps, 4) proposing energy strategies for intervention areas, 5) technical intervention possibilities, 6) intervention packages, and 7) SWOT analysis. In a project by Jafari and Valentin (2017), a model has been developed to evaluate the effectiveness of retrofitting efforts according to the investment cost and energy saving. The methodology of this study comprises four key steps of 1) data collection, 2) data analysis, 3) model development, and 4) model testing and validation.

### **2.7.1. Key phases of a building energy retrofit process**

Accordingly, there are three main steps for energy retrofitting process: 1) Pre-retrofit process, 2) Retrofit, and 3) Post-retrofit. The building retrofit optimization framework aims to determine, implement and apply the most efficient retrofit scenarios in terms

of energy and comfort improvements. In the line with the reviewed literature, the required actions in each three phase of the retrofit process can be elaborated as following:

- Pre-retrofit
  1. Gathering existing building information
  2. Energy Auditing and Performance Assessment
  3. Identifying energy demanding and discomfort areas
  4. Identifying retrofit actions and related technologies
  5. Selecting the best retrofit action (decision making process)
- Retrofit
  6. Implementation
- Post-retrofit
  7. Validation and verification

The process starts with collecting the existing building information to characterize its original and pre-defined conditions in terms of Key Performance Indicators (cost performance, safety, energy consumption, stakeholder satisfaction, and etc.). The relevant technical gaps can be identified in this step. Based on the gathered general data, in order to achieve building energy consumption profile, an energy auditing survey have to be carried out. Two vital steps for energy auditing are indicated as manual methods (gathering energy data from walkthrough and utility bills) and automated methods. In parallel with energy auditing survey, discomfort and problematic areas by employing user comfort survey and data loggers can be identified. Then, a general retrofitting actions, required viable technologies would be listed. The related energy protocols and regulations need to be taken into account in this step. The fourth step; selecting best retrofit actions, as the main core of every retrofit process, require a multi-criteria decision aid tool (MCDA). Making an appropriate decision on

selecting the best action in terms of energy saving, cost, and user comfort can be realized by the aid of MCDA tools. By means of all these steps, the retrofitting action are ready to execute and implemented on site. The whole process ends with the validation and verification. The described process is illustrated in frame of an IDEF0 diagram as seen in below:

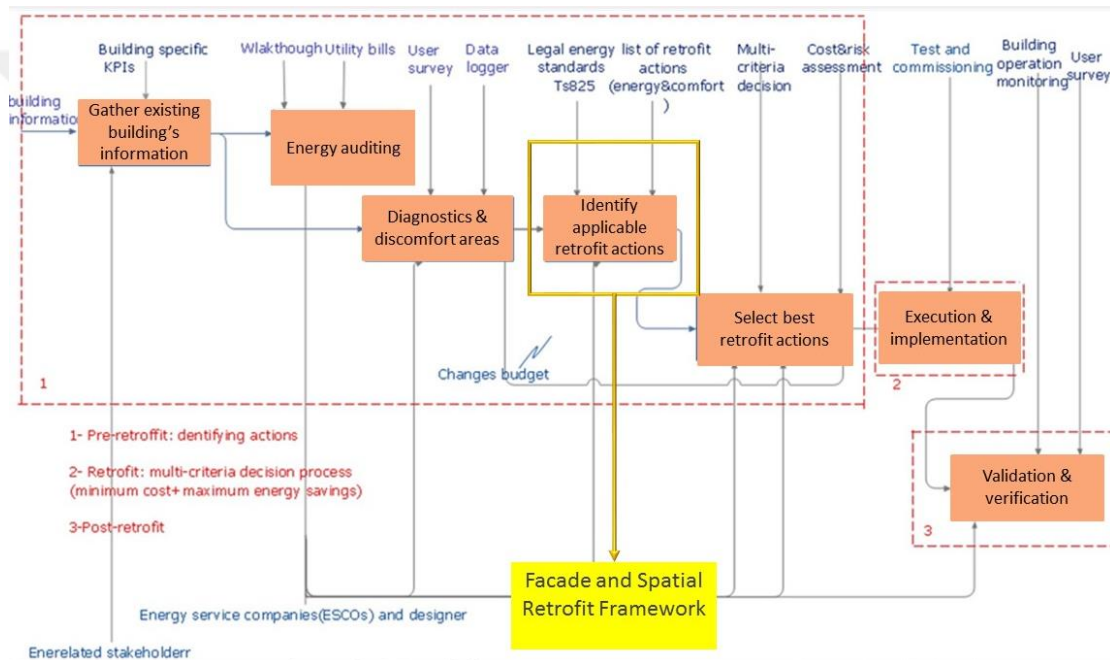

**Figure 2.8.** IDEF0 diagram of a systematic retrofit roadmap (by the author).

## 2.8. Benefits and Constraints of Passive Strategies

Passive retrofit measures including the installation of shading devices, insulation, and openable windows can improve the indoor comfort conditions. It's been proven that occupants of buildings relying mainly on passive systems have high degrees of satisfaction, even if the required codes or standards are not met adequately. The reason mostly attributes to the existence of adaptive opportunity, in which occupants are able

to adjust and change their indoor environmental condition to set their desired comfort level. Some characteristics of adaptive approach are: openable windows, adjustable blinds, local cooling/heating controls, workstation/furniture flexibility, access to daylight, and good views. The most significant benefit of passive strategies relates to the reduced energy consumption. Typically, air-conditioned buildings consume substantially, more energy than naturally ventilated buildings. The conducted studies on mixed climates also show that despite high running costs of air-conditioned office buildings, the satisfaction level of workers do not necessarily exceed the naturally ventilated buildings (Baker, 2009, pp.7-8).

## 2.9. Pre-Defined Conditions of the Existing Building

The current thesis aims to develop an energy retrofit framework, which focuses on two highly interdependent parameters: energy efficiency and indoor comfort. The Trias Energetica concept or the Kyoto Pyramid, based on Lysen's work (1996), introduces a three-step approach to energy efficiency: 1) reduce the energy demand, 2) use renewable energy, and 3) use the cleanest possible fossil fuels (Figure 2.12). The proposed framework in this study focuses only on the first step of the pyramid and tends to identify passive retrofit actions applicable on the façade system of the building that maintain a tradeoff between energy demand and user comfort. In the light with reviewed literature (Aksamija, 2013, p.18), four fundamental mechanism; thermal heat transfer, solar heat gain, air leakage, and lighting loads define the general performance and energy efficiency of a building's façade system.

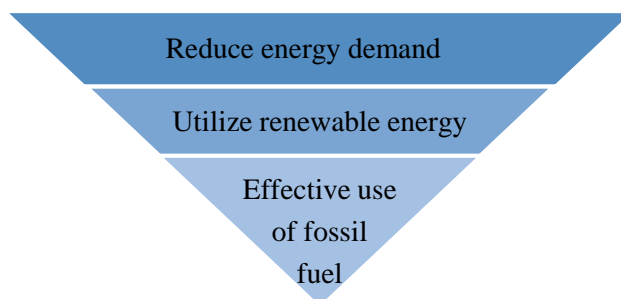

**Figure 2.9.** The Trias Energetica concept (Lysen, 1996).



### **2.9.1. Opaque and transparent façade**

Essentially, façades are classified into two main types: opaque façades and transparent (glazed) façades (Passe and Nelson, 2013; Aksamija, 2013). Opaque façades are comprised of solid layers of masonry materials such as, stone, metal or pre-cast concrete claddings with embedded punched windows. Glazed or transparent façades (i.e. curtain walls and storefront façades) consist of a large glazing surface either transparent, or translucent glass surfaces, which are fixed by metal framing elements (Aksamija, 2013, p.18). The main functions of opaque components are weather and moisture resistance, thermal control, and infiltration control, as well as, safety and acoustic protection. The visual connectivity and daylighting, as well as thermal control are in the responsibility domain of the transparent portion of the envelope system (Passe and Nelson, 2013, p.194). Ochoa and Capeluto (2009) claim that the facade is the key issue in maintaining the desired tradeoff between energy performance and occupant comfort, which is sensitive to several environmental factors. Determining an optimal façade is a complex action and often impossible due to the many, contradicting and interdependence parameters that drive façade performance. These performance indicators (Figure 2.13) varies from project to project and creating the desired balance between energy efficiency and comfort in each building depends on its particular pre-defined conditions (Ochoa and Capeluto, 2009).

### **2.9.2. Thermal load profiles in office buildings**

The very essential requirements of an office building is to assure comfortable, healthy, and productive environment for its occupants. Additionally, in line with the growth attention towards the energy use and its environmental effects, eliminating the energy consumption and the consequent emitted carbon dioxide in office buildings has become another vital requirement of office buildings. In offices, most of the consumed energy is due to commonly for cooling, ventilation, heating, lighting, equipment, and catering. The main energy sources are electrical and fossil fuel, which can be reduced by extending the passive zones and benefit from passive ventilation and daylight (Burton,

2013, P.3). Office buildings range from being ‘internal load dominant’ to ‘environmental load dominant’. Essentially, the building’s characteristics determine the thermal load profile of that building and then, the magnitude of the energy loads. Furthermore, retrofit solutions and attributed strategies to the thermal performance can be carried out in different directions. In other words, the retrofit action criteria needs to be selected based on the load dominancy state of the building (Rajapaksha et al., 2013).

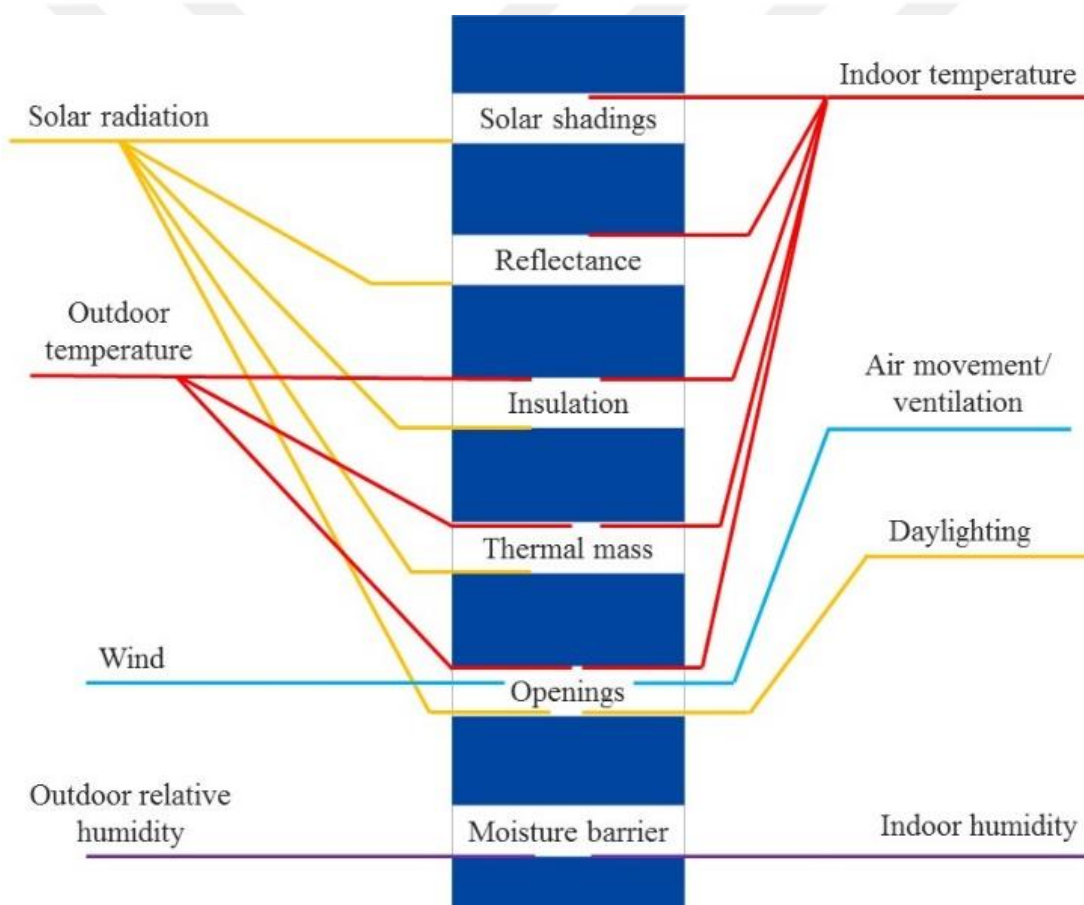

**Figure 2.10.** Environmental loads and façade performance (Carlson and Martinez Arias, 2014).

### **External loads (Externalities)**

Energy demands in response to providing the thermal comfort for indoor environments in coping with the impacts from outside are known as environmental loads or externalities. The required retrofit solutions for externalities should follow both environmental and technical aspects. Environmental factors cover solar radiation, wind, humidity, daylight, and microclimatic effects. Technical aspects include envelope architecture, building form (plan form, section, and internal zoning), and material components (Rajapaksha, Hyde, and Groenhout, 2013, p.70). According to Aksamija (2013), environmental load transfer can occur through three ways: 1) conduction and absorption through the opaque surfaces, 2) conduction and radiation through the transparent surfaces (glazing areas), and 3) convection through frames of openings (air leakage).

### **Internal loads (Internalities)**

Building energy demands in response to provide thermal comfort in coping with the generated loads from the indoor equipment, electrical lighting, and occupancy are known as internal loads or internalities (Rajapaksha et al., 2013, p.63). A study by Lam (2000) shows that the internal loads, which are lighting, occupancy and interior equipment are responsible for more than 50 percent energy use of the total energy consumption in a typical multi-storey office building. As Rajapaksha et al., (2013, p.70) indicate, the required solutions to maintain a control over internal loads should be proposed by considering both non-technical and technical systems. Non-technical aspects cover two major profiles; the occupancy profiles and the operational profiles. The former represents the number, distribution, and also the diversity of the occupants throughout the day (over time) and the latter, includes operational hours of equipment, like the HVAC system regarding the presence of the occupancy (After hours that there are no occupants in building or any inside zone of the building the operation of the HVAC system should be stopped). Technical systems cover three main aspects; HVAC systems (with regard the installed unit type and its operational mode), lighting systems,

and other plant or equipment (including lifts, pumps, etc.). The success key of achieving both optimized indoor environment alongside saving energy is to create a harmony between technical and non-technical aspects. Table 2.5 illustrates a brief review of thermal load profiles in office buildings and the contributing building components.

Both profiles of internal thermal loads and environmental thermal loads are inter-related to each other and all these areas should be taken into account in order to accomplish an efficient energy retrofit process. Architectural typology, building function, site enclosure and climate are the other important necessities of an energy retrofit project.

**Table 2.5.** Thermal load profiles in office buildings and their impacts on energy usage and comfort (Rajapaksha et al., 2013, p.68).

<b>Thermal load profiles</b>	<b>Contributing component</b>	<b>Impact on energy use and comfort</b>
Internal loads and occupancy (internalities)	Lighting Equipment Computers Occupancy	Heat emission to occupied spaces Heat and moisture emission to occupied spaces Heat emission to occupied spaces Affect the usage of lighting, equipment, and contribute heat and moisture to occupied spaces
Environmental loads (externalities)	External envelope  Internal mass  Infiltration (air leakage)	Transfers heat between outside and inside and increases cooling or heating demands  Absorbs and stores heat and increases cooling demands  Causes heat conduction and moisture convection between indoor and outdoor environment and increases heating/cooling loads

### **2.9.3. The impact of the building's orientation and form on developing passive retrofit process**

If the building is located along its east-west axis (the long side of the building will face in the north and south directions) three advantages can be observed: 1) admitting more daylight to enter a space, 2) preventing overheating by west-facing exposures during summer afternoons, and 3) benefiting from solar thermal energy of south façade in winter. As Straube and Burnett (2005) state, the south façade can absorb twice the heat gain of east and west façades in winter and west-facing façade generally, increases the building's cooling demand (Raji et al., 2017). Optimizing the winter solar absorption, is known as a complex dynamic function of orientation, building geometry, glazing ratio, heat-flow path, inter-zone heat transfer mechanisms and thermal mass (Yohanis, Norton, 2002). Several studies have investigated the impact of building shape on energy performance and have claimed that there is a tie relation between a building's compactness and its energy demands. These studies show that building shape (deep or shallow), its form (compact or atrium), orientation, its surroundings, and broadly speaking, its predefined conditions, influence building's energy demand and indoor comfort conditions (Steadman et al., 2000c; Aksoy and Inalli, 2006; Shahrestani et al., 2013). The diversity of building shape types makes the classification process a challenging task (Shahrestani et al., 2013). However, in the literature, the correlation between energy performance and building shape, is mostly allocated to the cubic shapes with square floor plans. Studies by Steadman, Bruhnes, and Rickaby (2000c) and Shahrestani et al., (2013) investigate the building's lighting type (sidelit or toplit) and internal spatial subdivisions, over the square deep and square shallow plans. Raji et al., (2017) investigate the impact of geometric factors for the energy-efficiency of high-rise office buildings in three climates of Amsterdam (mixed), Sydney (Sub-tropical) and Singapore (Tropical). The results of their study revealed that in the case of the mixed climate, there is a correlation between the annual total energy use and the relative compactness of building shape. In this regard, the larger the envelope surface area, the higher the amount of heat gains and losses occur through the building skin.

Consequently, compact shapes are more preferable for conserving energy in mixed climates. The study also refers to a substantial effect of plan depth on total energy consumption of the building in mixed climates. For shallow plans in order to decrease the electric lighting demands, office areas should be mostly accommodated along the building perimeter. They listed building geometry factors with respect of the highest to lowest impact as following: building orientation, plan shape, plan depth, and window-to-wall ratio. Nevertheless, energy retrofitting of office buildings without a comprehensive consideration of building's predefined conditions, will have a minor effect on improving its energy efficiency (Aldawoud, 2008; Safarzadeh and Bahadori, 2005; Tabesh, and Sertyesilisik, 2016). Being aware of these characteristics not only helps decision maker through selecting proper retrofit actions, but also helps him during the re-organization of the internal articulation related to the required comfort quality.

In this thesis, the targeted energy retrofit measures are measures, which improve both energy efficiency and indoor comfort quality. Accordingly, due to achieve a holistic picture of the joint framework for both energy reduction and comfort improvements, the interdependent relationships among building's form, façade condition, and interior spatial arrangements have been investigated.

According to the 2010/31/EU European Directive, establishing high comfort quality, particularly in the case of office, entails a substantial amount of energy consumption. This is because the fact that workers' comfort and wellbeing have a direct impact on their productivity at work and the loss of productivity means the loss of cost and investment of the organization. Thereupon, the conflict between high comfort quality and high energy demands becomes more prominent in office buildings (Roulet, 2001). Accordingly, a firm tie between energy performance of the building and its indoor comfort should be established through the retrofitting process. The following chapter describes different spatial arrangements in indoor environments of office organizations and their advantageous or disadvantageous related to the workers' comfort quality.

## CHAPTER 3

### 3. OFFICE ORGANIZATION AND ITS ELEMENTS

Palmer and Lewis (1977) in their book entitled *planning the office landscape*, analyze an office organization based on its elements and the existence relationship between those elements. They used the phrase of sociotechnical system for such organization, which consists of people, technical elements, and material resources. In other words, each organization is comprised of four main domains: procedures, people relationships, environment, and product. Product is the business objective of every organization and its success in profitability. To achieve this objective, comprehensive office planning either a new organization or retrofitting an existing one, needs to consider all the four elements and their relationships.

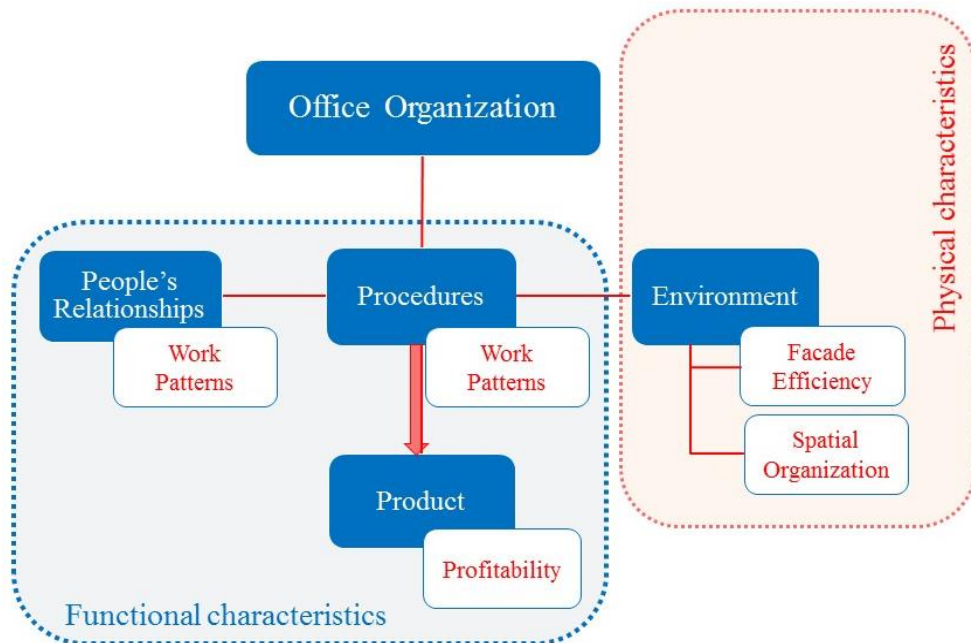

**Figure 3.1.** Major elements of office organization (based on Palmer and Lewis, 1977).

### **3.1. Different Methods in the Definition of Office Organization**

Between 1983 and 1985 Duffy et al. developed a multi-national client-sponsored research program, called 'ORBIT (Organization, Buildings, and Information Technology)', which was comprised of two studies. The first study was related to the impacts of new IT technologies on spatial organizations, and the second study was related to the changing pattern of work after the emersion of IT technologies. The workplaces based on the ORBIT studies were classified regarding two main dimensions of the 'nature of change' (the change potential of the environment; low or high) and the 'nature of work' (routine or non-routine work type). Broadly speaking, ORBIT research analyzed office typologies upon the functional features of the office environment (Duffy and Chandor, 1983). Ahlin and Westlander (1991) defined different office types according to the physical characteristics like the plan layout. Plan layout is defined in two dimensions of 'the plan model' and 'room type'. In extending plan model definition, they used three basic principles of spatial organization, which are: 1) cell-office; 2) combi-office; and 3) open plan office. Room type in their analyses is used to investigate individual office rooms, instead of the entire office environment like plan model. The room type is divided into three classes of single-rooms, shared-rooms (2-3 people/room), and large-rooms (more than 4 people/room). Duffy et al. (1973) in defining office typologies, combined the physical and functional characteristics. They denoted four basic office types, each with its particular work pattern and spatial organization. They gave nontraditional names to the categories, as following:

1. Cell: individual, enclosed, static workplaces
2. Club: high level, varied task, interactive
3. Hive: busy, dense, open, process oriented
4. Den: group work, project based

Danielsson and Bodin (2008) asserted that both methods are connected strongly, thus, they can be equivalent to each other. In their new office typology, the Cell is equivalent



of private cellular office, the Club is equivalent of combi-office, the Hive is equivalent of open plan office, and the Den is equivalent of landscaped office. Authors, by claiming that both definition methods have their limitations, based on the works of Ahlin & Westlander (1991) and Duffy & Powell (1997), identified seven different types of office spaces; cell-office, shared-room office, small open plan office, medium open plan office, large open plan office, flex-office and combi-office. As Danielsson and Bodin (2008, p.25) indicates, the open-plan office includes a wide range of subdivisions, which varies from 4 persons-room to more than 100 workers in a shared space. However, none of the reviewed studies have defined internal distinction between various types of open-plan offices. As Kim (1999) states, internal layout of offices can be generally articulated based on three planning options; closed, open and combination.

Briefly, in order to investigate the impact of office environment on workers' comfort it is necessary to define the considered different office spaces. The reviewed literature in this regard (Duffy, Cave, & Worthington, 1976; Duffy & Chandor, 1983; Duffy & Powell, 1997; and Danielsson & Bodin, 2008) revealed that traditionally there are two main methods to define office spaces; either by spatial organization or by work patterns, which respectively belong to the physical and functional domains of every office organization. However, as Danielsson and Bodin (2008) states, in spite of existing a firm connection between the two, considering only one of them in identifying office typologies will be not a holistic classification.

### **3.1.1. Predominant spatial arrangement concepts from past to present**

The key point in the design of office facility is that developments in this field need to reflect changing philosophies of utilizing workspaces. None of these philosophies or office concepts completely replaced one other. Rather, they are all still in use, representing different basic options for office design. As Van Meel and Voss (2001, p.325) remark, "Offices reflect ideas about the meaning of work and opinions about how work should be performed. As these ideas change over time, so does the office." Van Meel (2000), describe four predominant office types as followings:

- Cellular office: An enclosed space designed to accommodate 1–3 workplaces
- Group office: An enclosed space designed to accommodate 4–12 workplaces
- Open-plan office: An enclosed space designed to accommodate 13 or more workplaces
- Combi-office: Closed offices situated in an open space which is designed to accommodate common facilities and group work

Office environment in Van Meel (2000) framework is distinguished in three levels of *place* (central office, telework office, business office, etc.), *space* (cellular, group, open-plan, or combi office), and *use* (personal office, shared office, hoteling, and etc).

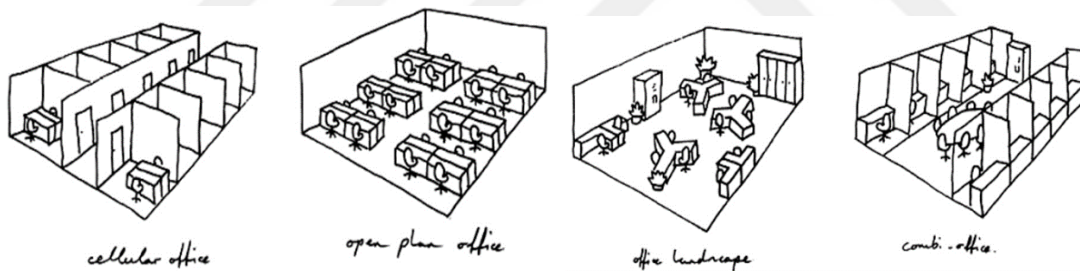

**Figure 3.2.** Principles of different office concepts (Van Meel, 2000).

The following sections elaborate some of the predominant office space layouts throughout the office building history from the pre-1960s till present and also the estimated office spaces for the near future.

*Bull Pen office:* until the 1960s staff were placed in open space at the core of plan with rigid arrangements and in contrast, one or more sides of the building perimeter zones (windowed spaces) were allocated to single offices for executives (Palmer and Lewis, 1977). In 1924, the first definition of thermal comfort standard published by ASHVE

(Ashve, 1924) and in 1938 the first code for comfort requirements in air conditioned environments was published (Ashve, 1938). In this situation, the development of deep floor plan layouts was facilitating.

*Single office:* in early 1960s single office concept in deep plan buildings, brought staff from open spaces to closed-plan offices occupied by one two or more workers. Again the executives stayed in their windowed spaces. In these decades office spaces were typically combination of bull pen and single office concepts (Palmer and Lewis, 1977).

*Executive-core deep cellular office:* from the early 1960s till the mid-1960s, the locations of staff and executives replaced with each other. The staff located around the building perimeter near windows and in an open zone and executives placed at the core of plan in single offices (Palmer and Lewis, 1977).

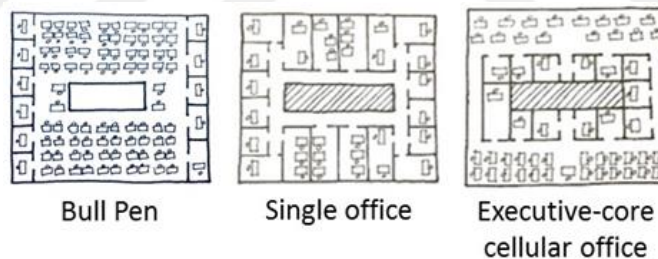

**Figure 3.3.** Evolution of single office concept from pre-1950 till mid-1960s (Palmer & Lewis, 1977, p.3).

*Open-plan office:* open-plan office concept was a major phase in office buildings history because for the first time both staff and executives are placed at the same interior conditions and same working zones. This period was the era of deep plan artificial office environments. By developing air-conditioning system and artificial lighting, offices extending into deeper spaces became preferred because interior spaces were not dependent on natural light and ventilation anymore. Design of curtain walls

and large windowpanes introduced in this period (Collard and DeHerde, 1997). Implementing openable windows converted bioclimatic building facades into fully sealed and protected against outside environment. In 1966, the first code of minimum comfort for air-conditioned environments was published by ASHRAE Standard 55-1966.

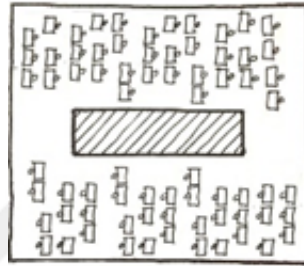

**Figure 3.4.** Open plan office in mid-60s, rigid arrangements (Palmer & Lewis, 1977, p.4).

*Landscaped office:* developed in early 1970s by the Quickborner Team of Germany. Since, these type typically require a much deeper and larger spaces, they were not preferred by organizations. Like open plan concept, this concept also lays out a large deep floor plan, however, the arrangements are not in a rigid geometry. Workstations are randomly arranged along with a complete artificial lighting. Moveable screens, partitions, and plants are main components of this type of organization to provide circulation routs and identity to the working groups (Duffy et al., 1976, p.81).

*Combi-office:* the development of office interior environments from the 70s to the 90s is featured by the use of communication technologies and their impact on work styles. Increasing the ergonomic quality of the office interiors appeared also in this era. These changes led the working spaces to be more workflow- oriented group spaces and the creation of new office layout called as combi office, which is a combination of private cellular offices and shared open spaces for group working teams. Implementing unitized curtain walls was also privileged in this period. The energy crises of the 1973 begins energy saving issues in construction industry. The fluorescent lamps and tinted

(coated) glazing were one of the results of efforts to limit energy consumptions. Natural ventilation and daylight gains became again popular in designing interior environments (Palmer and Lewis, 1977; Van Meel, 2000).

*Reversible offices (current and near future office concepts):* the 1990s was the era of efficiency and profitability trends. Work spaces were faced with new issues like, internet and needs for more spatial flexibilities. On the other hand, due to the high prices of office spaces on commercial building market, design concerns for shared work stations reduced. This situation provided the ground for the appearance of a new office concept called, *Reversible Office* (Pickardchilton, 2012). Reversible offices with their flexible arrangement, embrace different spatial organizations for different workers' needs. These types of layouts typically require minimum thermal mass with maximum flexibility like, light walls and suspended ceilings. The demand to add value to workplace performance transforms office definition from an IT place to a place for breeding creativity. As the result of information technologies, 1990s witnessed a second workplace revolution, which was the emersion of “new ways of working”. Information technology changed cultural and social processes. Gradually, virtual world and digital tools opportunities displaced face-to-face communications (Harrison, Wheeler, & Whitehead, 2004).

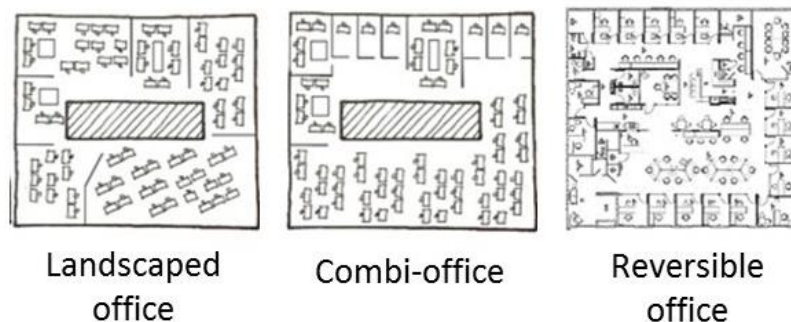
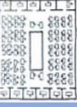







**Figure 3.5.** Spatial arrangement concepts from 1970s till today (Palmer and Lewis, 1977).

*Tele-offices (estimation for future office spatial arrangements):* achieving high profitability with limited budget is the goal that will be focused in near future office organizations more than past. There is always an emphasis on reducing initial and running costs from the stakeholders and building owners. In this context it is expected that tele-working might be a good alternative, which is indeed independent home-offices or tele-offices, but consists of a central office for meetings or communications. Workers will feel more flexibility regarding their work time and place (van Meel, 2000). The future offices are estimated to be more interactive, more specialist, and less individual workplace-based spaces (Stratton, 1997, p.85).

As a matter of fact, there are many different types of office management and work styles, thus we witness various types of pre-dominant office layouts and spatial arrangements with different organizational demands (Table 3.1). However, based on reviewed literature on the history of different office layouts, it can be concluded that four main office arrangements were mostly used through the history of office buildings, although they are given different names by several authors and research works. These four distinct types are, single closed offices, group shared offices, open shared offices, and landscaped shared offices. Among the all conducted valuable research on the topic of office buildings, the view point of Francis Duffy is rather holistic. Furthermore, the foundation of the current thesis for the investigation of energy and comfort triggers within existing office buildings, is set on Duffy's office framework, which is elaborated in the next section.

**Table 3.1.** A summary of pre-dominant office layouts from early 1960s till present (by the author).

Spatial Organization Typology	Image	Period	Appeared Building Technologies	Influential Factors	Philosophy	Staff Spatial Arrangements	Number of Workers	Plan Architecture	Appeared Facade Trends	Comfort Standards	Source
Bull Pen Office		Pre-1960s	-Steel constructions -Elevator -Light bulb	-Industrial Revolution -World War II	Representative arrangement	Staff-core concept: Executives located in windowed closed rooms, staff placed in open core zone	Single executive rooms + up to 20 staff in open zone	Closed-plan rooms+ large open space	Controlled interaction of the inside with outside by occupants	First definition of thermal comfort standard by ASHVE. Looking for optimum environments for thermal comfort.	(PickardChilton, 2012)/ (Brager & de Dear, 2003)/ (ASHVE,1924)/(Palmer & Lewis, 1977)/ (Gottschalk, 1994) Images: (Palmer & Lewis, 1977)
Single Office		Late 1950s-early 1960s				Staff and executive are located in single rooms	1-3 persons	Closed-plan			
Executive-Core Cellular Office		Early 1960s-Mid 1960s			Combination of bull pen and single office	Executive core concept: staff placed in open windowed zones, but executives placed in closed rooms at the core	Single executive rooms+ up to 20 in open zone	Closed-plan + medium open plan			
Open-Plan Office		Mid 60s	-Fluorescent lamps -Air-conditioning -Float glass -Curtain wall -Relocatable partitions	-Mass production -Prefabrication -Growing cost of construction -Increased workers population	Organizational flexibility	For the first time, both staff and executive (around windowed zones) were placed in open and similar quality offices.	More than 20 work stations	Medium/large open-plan	Facades with large windowpanes. On-site Curtain walls. Mostly artificial office environments. Fully sealed protection facades.	Defining minimum comfort codes for air conditioned offices. Introducing comfort as "condition of mind feeling thermally satisfaction"	(PickardChilton, 2012)/(Brager & de Dear, 2003)/(Collard & Deherde, 1997)/ (Palmer & Lewis, 1977)/ (Gottschalk, 1994) / image: author
Landscaped Office		Late 60s-early 1970s	-Modularity		Ergonomic work environment	The staff became a middle-management and clerical level of executive staff decreased.	Open group spaces shared among 6-20 persons	Medium/large open-plan			
Combi Office/ professional grouping		1970s-1990s	-IT technology -Mirrored / tinted glazing -fluorescents	-Energy crisis -Sick Building Syndrome	Communicative & teamwork space structure	A group of 5-15 professional staff located in closed rooms. Other staff members located in open space zones	Cell/group offices + multi-functional zones	Partitioned medium sized open-plan	High-tech unitized curtain wall facades, active occupants	Static heat balance models, occupants' passive role	(Eisele & Staniek, 2005)/ (Schäfer, 1998) / (Van Meel, 2000)/ (Gottschalk, 1994)/ image: author
Reversible Office		1990s-today	-Internet	-Kyoto Commitment	Time and Organizational flexibility	Work zones for both staff and executives are flexible in place or location.They can work anytime and anywhere	Flexible multi-layout office	Medium/large multi-functional zones	Active occupant interaction between inside& outside	Adaptive thermal comfort models, occupants' active role	(Duffy, Cave, & Worthington,1988)/ (PickardChilton, 2012)/ image: myofficeandmore.com

### 3.1.2. Duffy's office environment framework

In Duffy's framework, four main types of organization namely, concentrated study (Cell), group process (Den), individual process (Hive), and transactional knowledge (Club) are examined. The following section, firstly, argues the Work Pattern typology of Duffy's framework and then, the spatial requirements of different organizational structures will be discussed.

#### 3.1.2.1. Duffy's office environment framework: generic work patterns

The NEW (New Environments for Working) project conducted in 1997, was an investigation in a joint attempt by Duffy, Eley, Giffone, & Worthington and the Building Research Establishment. This project was looking at the modern working practices and generally, the ways people work in their workplaces. The output of the project was four office layout typologies developed based on their particular kind of activities. They were broadly categorized as, Cell, Den, Hive, and Club (Duffy and Powell, 1997). *The New Office* (Duffy and Powell, 1997) principles, under the umbrella of the technology relied on high level of autonomy, face-to-face interactions, and broadly speaking highly motivated workers. Today, these types of workplaces are known as 'knowledge work' because encourage the knowledge transfer and connectivity rather than linear business systems (Harrison et al., 2004, p. 29).

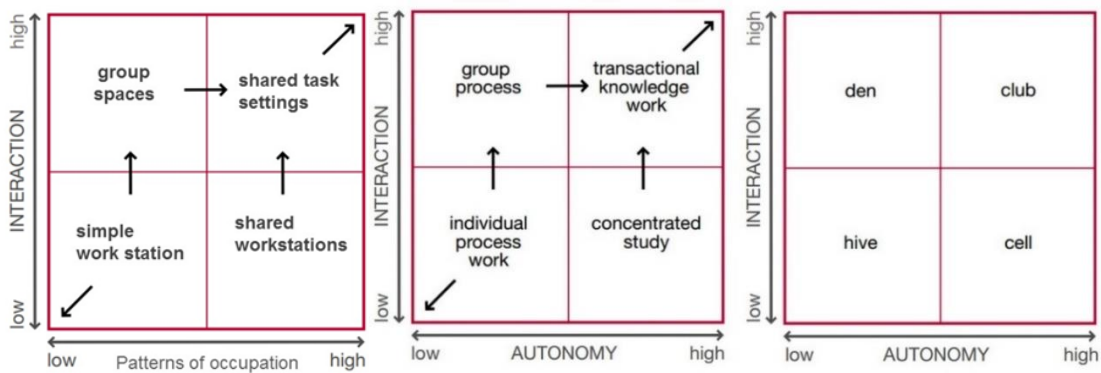

**Figure 3.6.** Duffy's work typology (Harrison et al., 2004, p. 27).









Every work pattern requires its particular organizational structure. In the other words, different organizational structures will create various types of office spatial arrangements. Each layout type also has entirely different patterns of occupancy and IT equipment. The terms of “interaction” and “autonomy” as two aspects of the work pattern, can help businesses to have a perception of how they are now and where they may be in the future. Interaction represents the amount of face-to-face communication during the work process and autonomy is the degree of individual’s control on the timing and work method, like when and how work processes are carried out (British Council for Offices, 2005). Duffy (1997) by referring to the fact that the relative demand for each layout will change by the time, indicates that “It is expected, as information technology changes, that many examples of the offices now identified as being for ‘group processes’ [dens] or ‘concentrated study’ [cells] will tend to converge into what has been called the ‘transactional’ office [club] where, through deft management of time and space, both interaction and autonomy will be maximized.”

#### **3.1.2.2. Duffy’s office environment framework: spatial arrangements**

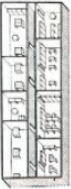
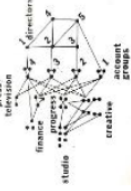
Duffy et al. (1976) used the term *Scenery* in describing the interior spatial arrangements, however, this thesis will continue with the well-known phrase of *Spatial Arrangements*. In exploring the relationship between different work patterns and office layouts, they classified spatial arrangements in four generic types: cellular, group space, open plan, and landscaped. These arrangements can be used for a whole office building, or a part of that, even for a small part of a floor plan. An existing office layout can be either only one of them or a combination of all types. Table 3.2 illustrates the provided organizational samples by Duffy et al. (1976, p.83) for every work pattern and suitable office spatial arrangements.

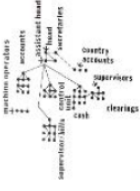
**Table 3.2.** Types of spatial arrangements and their needs (Duffy et al., 1976, p.83).

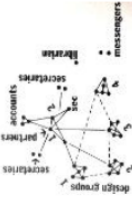
Schematic Plan Architecture	Plan Depth	Spatial Arrangement	Work Pattern Typology	Interaction Level Typology	Interaction Level	Space Occupation Patterns	Organization Needs	Schematic Interaction Links	Organization Example
	Shallow (Perimeter dependent)	Cellular	Cell	Concentrated Study	Little Interaction	Individual or Shared Workstations	Isolated executive with secretarial support		Top Management
	Shallow or Deep	Group Space	Den	Group Process	Interaction with Separation	Group Spaces	Isolated work groups, coordinative work. Directors not involved in day-to-day work		Advertising Agency
	Deep (Artificial Environment)	Open Plan	Hive	Individual Process Work	Much Interaction	Simple Workstation	Large supervised groups. Highly interactive groups. No public entry.		Clerical Office
	Deep (Artificial Environment)	Landscaped Plan	Club	Transactional Knowledge Work	Interaction with Separation	Shared Task Settings	Interactive project-based groups in weak touch with each other. Partners in close touch.		Design Office

However, in selecting the appropriate arrangement for an office interior there may not be always a precise fit in the matrix, illustrated in Table 4. A wrong choice of spatial arrangement will lead to a difficult working conditions (Duffy et al., 1976, p.81-82).

*Cellular* office concept is typically used in buildings with narrow plan with maximum 12 meter depth. The plan architecture commonly consists spine corridors, which are embracing several single rooms. Almost for all services, rooms depend on building perimeter zone. Usually, the maximum number of workers in these kind of concepts does not exceed five persons. Cellular offices more than any other type provides the ideal satisfaction for occupants to work in behind closed doors in their own territory without distraction (Schittich, 2011). *Group Spaces* are medium-sized rooms containing 5-15 persons as a team workers. The proper depth of plan for these rooms is a little bit deeper compared to the cell offices and almost 15-20 m depth is required. *Open Plan* is the traditional way of spatial arranging a large deep floor plan, which contains more than 20 persons in a very rigid arranged workstations. The tasks are individually processed. *Landscaped Office* is a relatively short-lived typology, which developed in early 1970s by the Quickborner Team of Germany. Like open plan, this concept also lays out a large deep floor plan, however, the arrangements are not in a rigid geometry. Workstations are randomly arranged along with a complete artificial lighting. Moveable screens, partitions, and plants are main components of this type of organization to provide circulation routs and identification of the working groups (Duffy et al., 1976, p.81).

### **3.1.2.3. Duffy's office environment framework: depth of plan**

As discussed in previous sections, if the purpose of a retrofit project is reducing energy consumption of the building and focusing on passive retrofitting solutions, the first essential step is identifying the impact area of those passive actions (windowed area) in the interior part of the building. To clarify the accessibility of an indoor office environment to this zone, the space-depth definition of Duffy et al. (1976) has been considered. The basic grammar for office plan architecture in their study is defined by

identifying the building core position. The location of core determines the depth of plan and this can lead to creation of different office arrangement possibilities. Depth of space in their book is defined as the distance from the main core to the building perimeter. Accordingly, Duffy et al. (1976, p.42) classify plan depth types as: shallow, medium-depth, deep, and very deep. Each type is elaborated as following:

- Shallow plan: are typically linear zones, which can be created either on a linear space or a non-linear space. The depth in central core types ranges between 6-7 m and in sided core types ranges between 12-14 m. The provided small rooms (2:1 ratio) following a corridor are such spaces. These rooms can easily benefit from perimeter ventilation and natural daylight.
- Medium-depth: some workstations may not be adjacent to the window wall. The distance between the core and the building perimeter ranges from 8 m to 12 m and if it is a side-core structure, this distance will vary from 16 m to 24 m. Planning a medium-depth space is easier than a shallow or deep space because all types of office layouts can be arranged in these spaces.

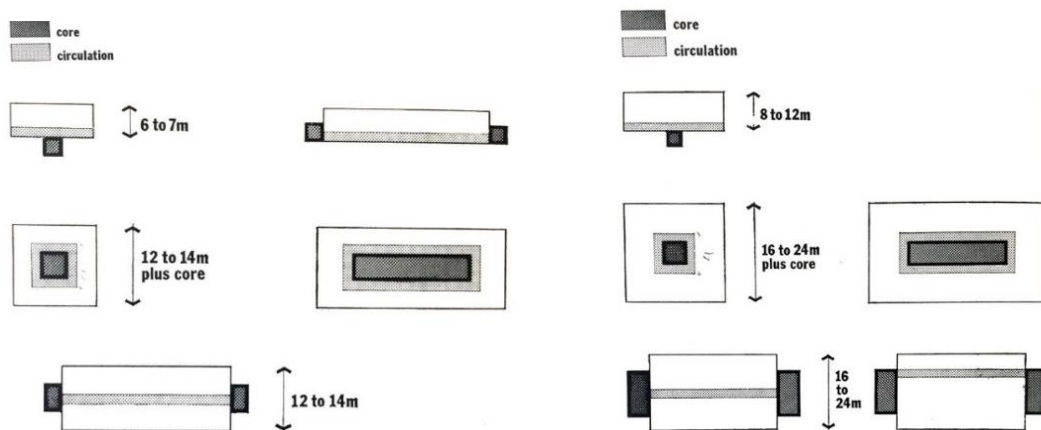

**Figure 3.7.** Left: shallow space and core position type, right: medium-depth space (Duffy et al., 1976, p.42).

- Deep space: The depth in deep spaces with central core ranges between 13-21 m and sided core types will give a space with near 32 m depth. Deep spaces can be subdivided into cellular offices, group offices or be used as an open-plan office without subdivisions.
- Very deep space: if the distance between core and windowed wall exceeds 20 m, that space is called a very deep space. For these kinds of office spaces, several circulation routs need to be defined. It is also possible to provide a combination of shallow and medium-depth spaces.

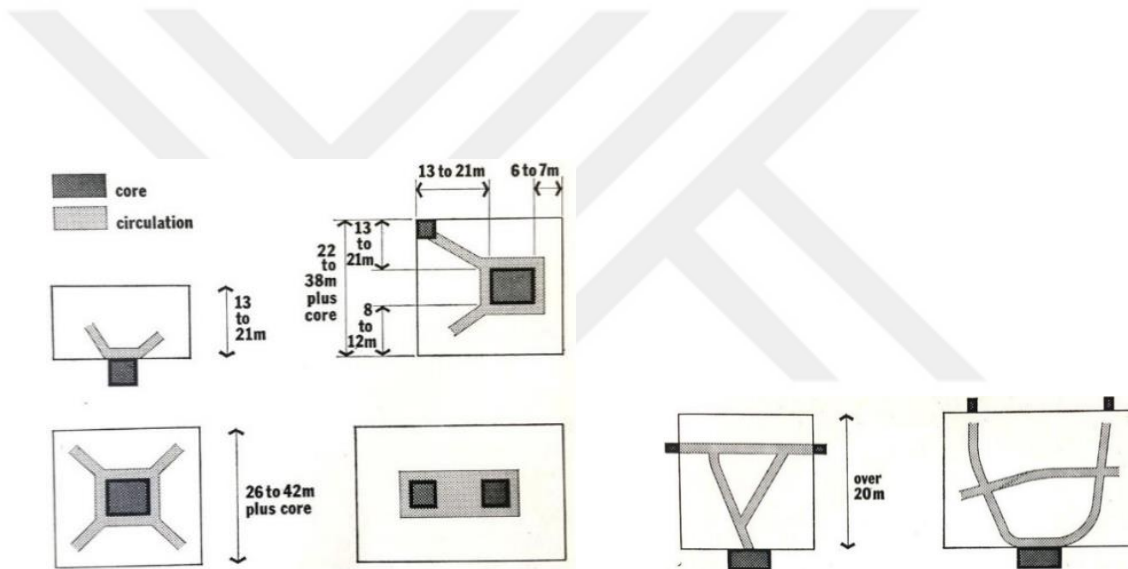

**Figure 3.8.** Left: deep space, right: very deep space (Duffy et al., 1976, pp.43-44).

From the view point of spatial arrangements, cellular offices and in some cases, group offices are spaces with shallow plans, although group offices can also be seen in medium-depth and deep plans as a subdivision part. Open and landscaped offices both require a relatively deeper floor plan (Duffy et al., 1976, p.81).

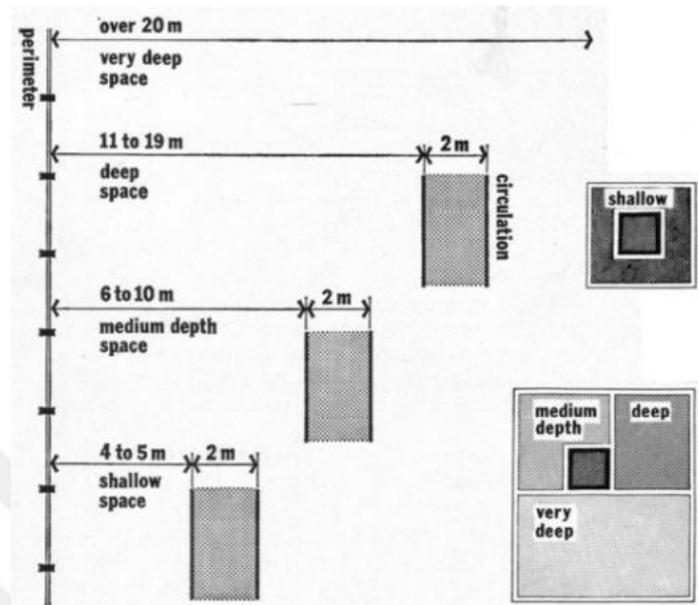
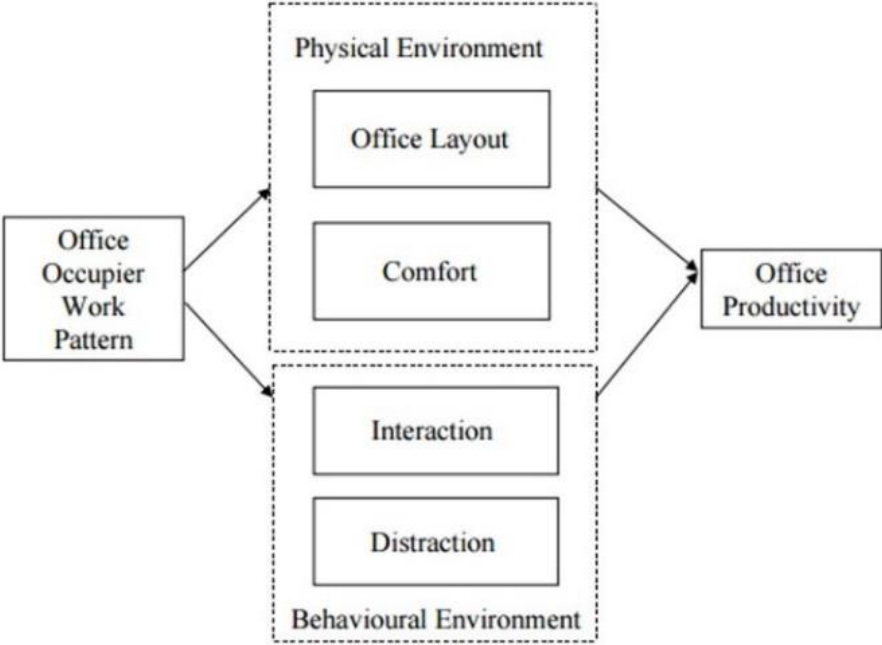

**Figure 3.9.** Different depth spaces (core to perimeter distance) (Duffy et al., 1976, p.81).

### 3.2. Spatial Comfort in Office Environments

As mentioned already, office spatial arrangements have a considerable impact on organizational performance and productivity, however, obtaining a greater efficiency and productivity requires the provision of a comfortable and satisfying work environment. De Dear and Brager (2002) claim that the insight of spatial comfort has evolved through the history under the influence of different social, technological, and cultural factors, such as technological inventions, changing work styles, and occupants' changing role. On the one hand, providing an ideal spatial comfort level in every office environment needs to consider all these influential aspects. On the other hand, in order to realize the effects of each layout type on indoor comfort and energy savings it is essential to identify a list of both interior and exterior design variables. Reinhart (2002) classifies interior design variables for open-plan and landscaped open offices as following: 'workstation size', 'partition height', 'floor to ceiling height', 'corridor width', 'ceiling reflectance', 'partition reflectance', and 'floor reflectance'. For the influential external variables on comfort and energy efficiency, he refers to 'façade

orientation’, ‘blind control’, ‘visual transmittance of windows’, ‘external obstruction’, and ‘climate conditions’. Vischer (2008) categorized these variables into two main groups: ‘the environmental’ and ‘behavioral’ aspects of workspace. The environmental aspects include ambient environmental conditions (noise, lighting, air quality, thermal comfort), furniture layout and ergonomics (workstations, offices and shared amenities), and process issues, such as user participation in design, and meeting business and organizational objectives. The behavioral aspects include employee’s satisfaction and feelings regarding their work environment in the sense of territory, ownership and belonging, and employee productivity. Vischer (2008) believes that environmental factors affect the worker’s psychological feelings, which is in a direct relation to the job satisfaction. In Haynes’s (2007) theoretical framework, the office environment is attributed to two distinct dimensions of physical environment and behavioral environment. The physical environment includes comfort and office layout and the behavioral environment is analyzed based on interaction and distraction dimensions.



**Figure 3.10.** Theoretical framework of office productivity (Haynes, 2007, p.106).

The mentioned studies represented a hierarchical process for worker's perception of their workplace environment. As Figure 3.11 shows, a three-way definition of the comfort concept has been carried out in several studies regarding office indoor environment. It clarifies that worker needs more than healthy and safe indoor environment. A worker needs environmentally supportive office for his activities (Vischer, 1996). Occupant's physical comfort refers to meeting the fundamental human needs, like safety, hygiene and accessibility, without which a building is uninhabitable. The functional comfort refers to the state of environment, which supports worker's tasks (Vischer, 2008, p.98). The third comfort dimension, called, psychological comfort includes feelings of belonging, territoriality and the ability of control over the workspace (Vischer et al., 2003).

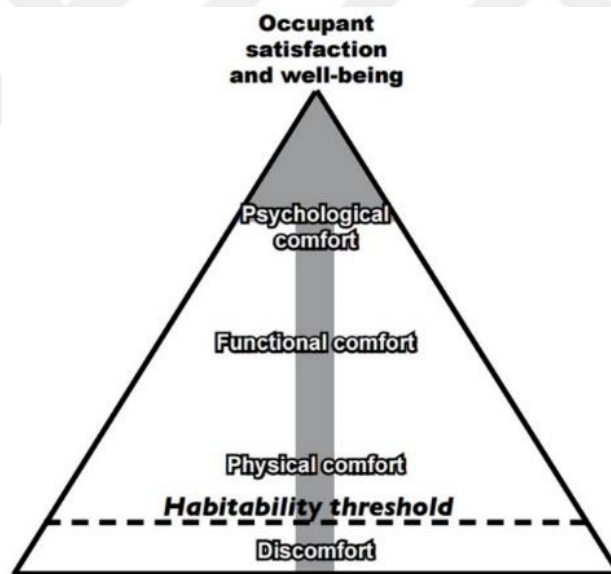
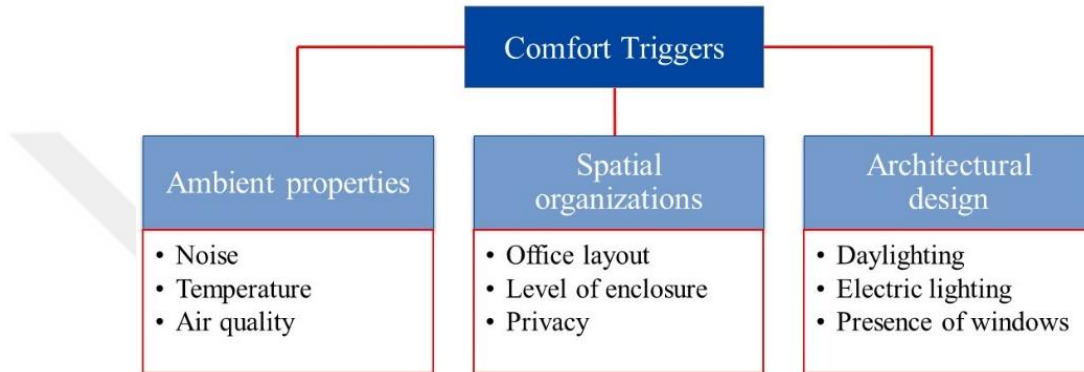

**Figure 3.11.** Environmental comfort model of workspace quality (Vischer, 2008, p.101).

In a review by Shea et al., (2011), which contains contributions of twenty seven studies on the impacts of physical work environment on comfort, a list of physical work environment properties has been presented. Significant factors within the physical work environment that may affect worker's comfort can be classified as three broad



areas: ambient properties, spatial arrangements and architectural design. Ambient properties refer to stimulations like, noise, temperature, and air quality; spatial arrangements are denoted as office layout, level of enclosure (number and height of partitions) and privacy. Architectural design refers to issues like, daylighting, task lighting or the presence of windows (Figure 3.12).



**Figure 3.12.** Physical work environment factors that impact on worker (based on Shea et al., 2011).

### Literature Evaluation

Reviewed studies demonstrated that relative influence of various factors affecting overall comfort perception of indoor environment varies for occupants of different office layouts. Visual privacy and noise level recognized as priorities for open-plan office users, whereas amount of light, social interaction, air quality, and thermal comfort were more important to private office occupants. User satisfaction regarding the interaction issue realized higher for employees of closed-plan offices, which have very low dissatisfaction rate. Briefly, even though workers are satisfied with interactions in open-plan layout, but their overall indoor comfort and workspace satisfaction is strongly tied with ambient properties such as, visual and audial privacy, temperature and lighting quality. Thereupon, the overall user comfort is achievable, firstly, through the selection of a proper spatial concept, which is the best suited to the

organization’s work process and secondly, through the indications of the discomfort sources caused by poor façade performance of the building. As discussed previously in the study of Shea, Pettit, and De Cieri (2011), the main discriminant comfort requirements are remarked as optimum temperatures, daylight accessibility and audial privacy.



**Figure 3.13.** The interdependent relation among indoor comfort, spatial arrangements, and façade performance (by the author, based on the reviewed literature).

In the light of reviewed literature, in order to establish the required comfort quality, the retrofit interventions are classified in this thesis in two categories: 1) *Spatial Retrofit* (SR) and 2) *Facade Retrofit* (FR). Spatial interventions represent applicable retrofit actions on the interior parts and are divided into internal and peripheral zones, which are elaborated in Section 4.2. Façade interventions form the basis of the façade retrofit framework, is represented in Section 4.3.

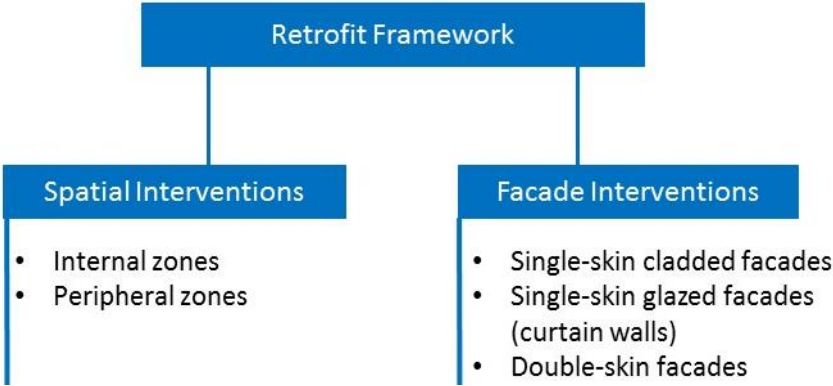

**Figure 3.14.** The general structure of proposed retrofit actions in the Retrofit Framework.

The three-headed process is considered for the generating retrofit framework; 1) the building scale: identifying pre-defined characteristics of the existing building for improving energy performance, 2) the room scale: developing a spatial comfort framework for five different office layouts façade scale, and 3) the façade scale: organizing effective passive retrofitting actions on existing. The investigation of these three major dimensions structures the main approach of this thesis, which is generating a comprehensive passive retrofit framework for existing office buildings. Each domain is elaborated in Chapter 4.

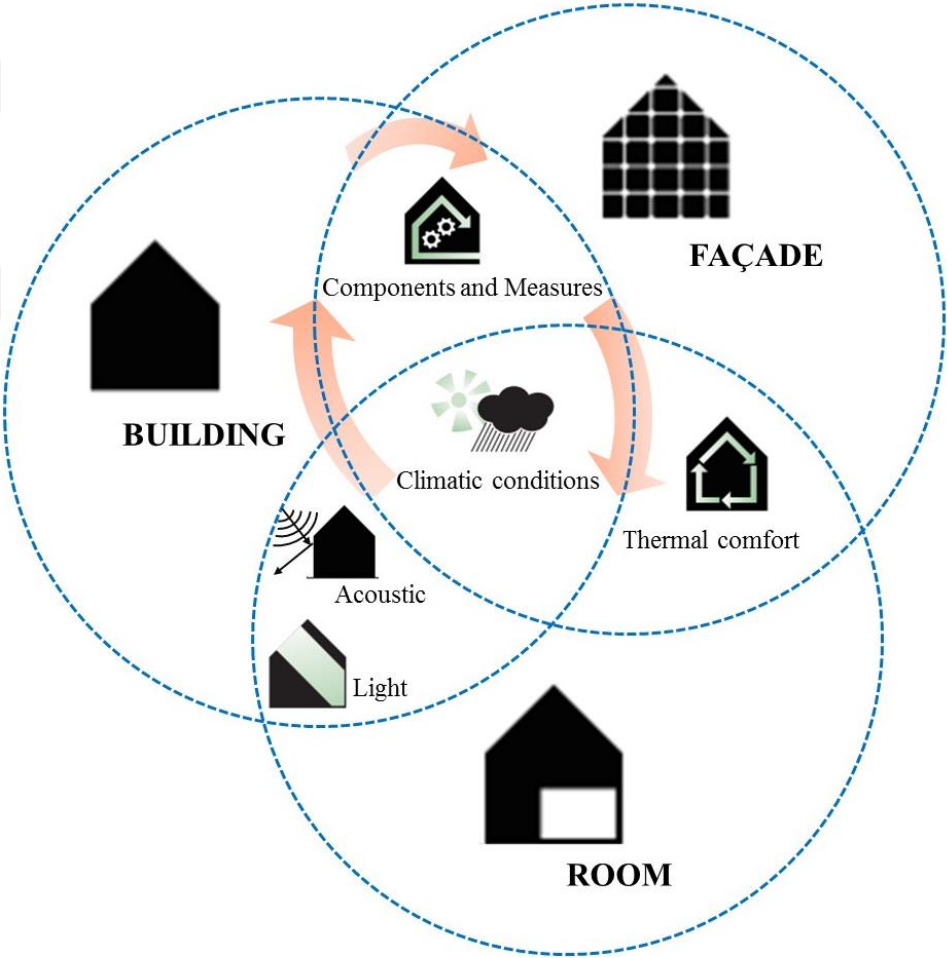

**Figure 3.15.** The three-step process of retrofit framework (by the author).



## CHAPTER 4

### RETROFIT FRAMEWORK DEVELOPMENT

In order to achieve a holistic picture of the joint framework for both energy efficiency and comfort, the interdependent relationship among building form, façade design, and interior spatial arrangement needs be investigated (Figure 4.1). Here, the building façade plays the role of a mediator between the outdoor and indoor environments.

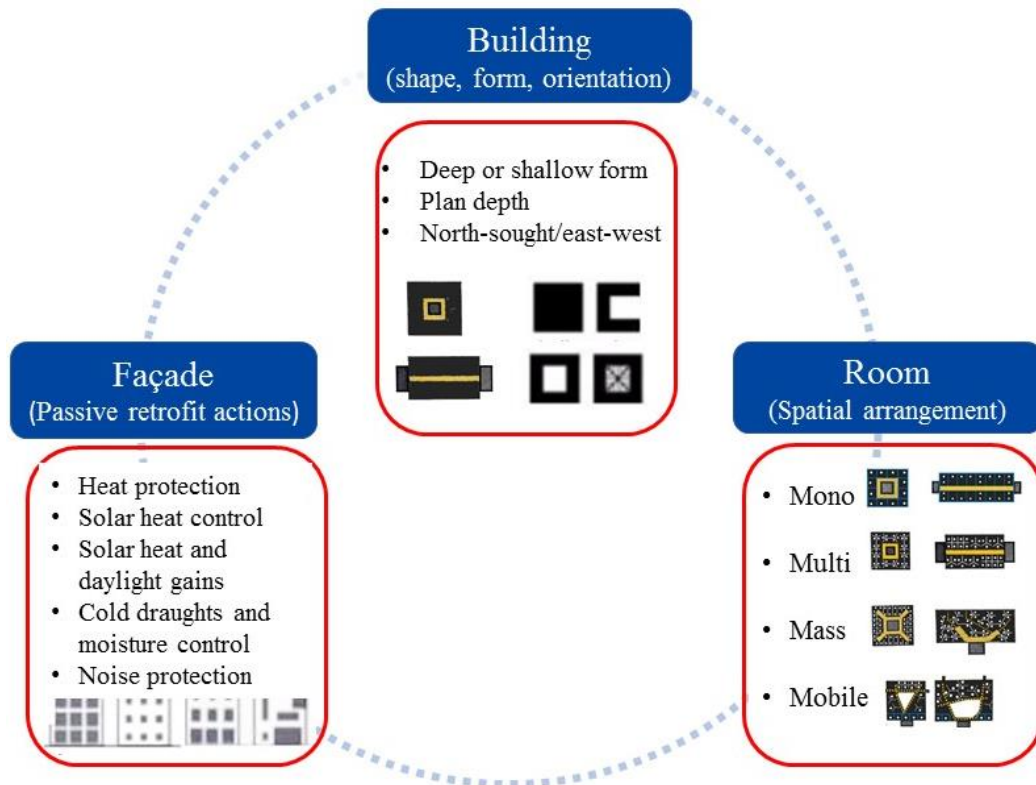

**Figure 4.1.** Interdependent relationship among three scales.

Architectural decisions on building form and orientation affect heating and cooling loads, daylight, passive ventilation, and solar heat gain opportunities. Building shape associates with the relative length of the overall dimensions (height, width, and depth), building form is defined as small-scale variations in the shape of the building. For small buildings, especially, with low-performance envelope systems (i.e. low level of insulation, high U-value windows without shading devices) the characteristics of shape, form, and orientation become more significant. For large buildings with low-performance envelope, internal heat loads (occupants, lighting, and equipment) overcome to the façade heat gains. However, in buildings with high-performance envelope systems (i.e. highly insulated windows with low U-value, appropriate shading strategies, and passive ventilation), building shape and form will have a relatively smaller impact on heating and cooling demands. For existing buildings there is not the possibility of any retrofit actions regarding the orientation changes, but through the decisions on choosing proper retrofit technologies it should be taken into account, since different building face require different strategies in terms of daylight, views, and noisy contexts (Harvey, 2012, p.110).

#### **4.1. Identifying Pre-Defined Characteristics of the Existing Building for Improving Energy Performance: Building Scale**

The decision maker's job regarding the different applicable façade retrofit options is to understand the existing building requirements, as well as the constraints, which can affect negatively the building performance even, after the retrofit process (Konstantinou, 2015). As described in previous sections, implementing the properties of a high-performance façade, essentially, depends on the pre-defined indicators of the existing building, like building's location, climatic characteristics, orientation, and etc. According to Aksamija (2013, p.18), climatic issues need to be considered from the outset of an energy retrofit project and the selection process of optimal retrofit actions should be based on climatic considerations. This thesis has put its climatic concerns on the most critical climatic zone of Turkey in terms of future energy demands, which is the Central Anatolian region. It is known in both phrases of dry-temperate and mixed-

dry climatic zone. Different climate classification systems have labeled this region in different names or codes, which is elaborated in the next paragraph.

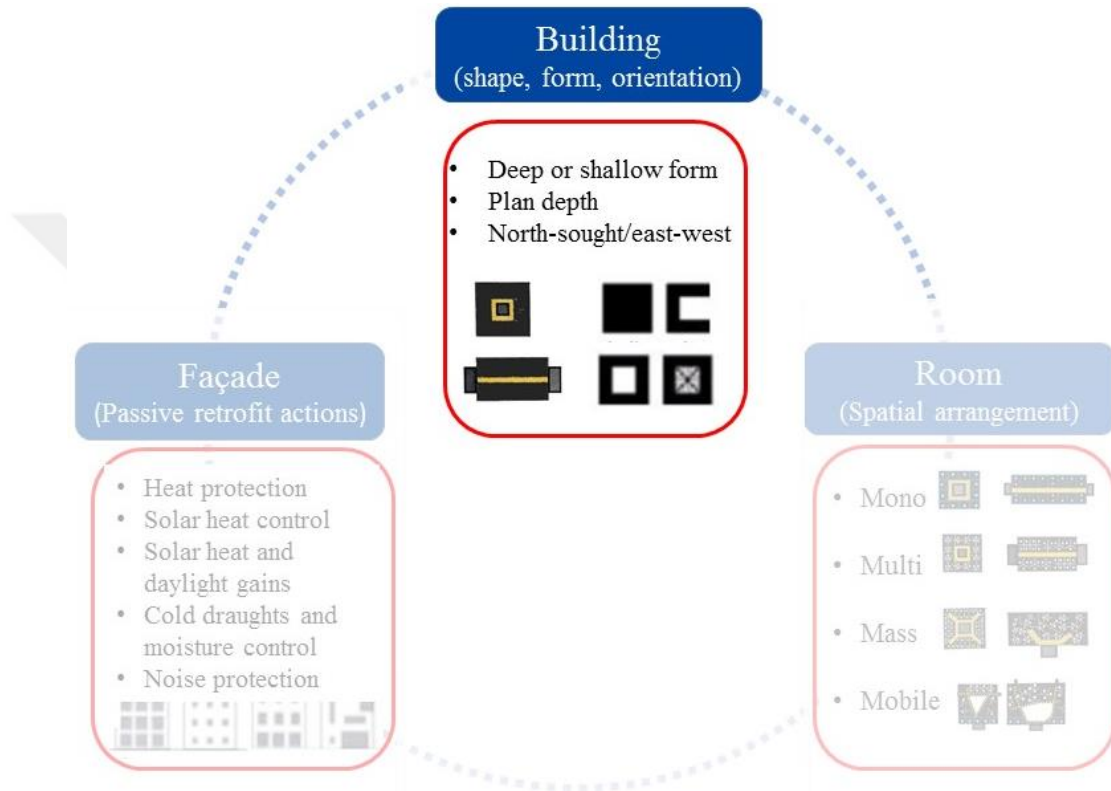

**Figure 4.2.** Effective pre-defined condition of the existing building on the performance of passive actions (by the author).

### Mixed-dry (4B) climatic zone

According to Köppen Classification Turkey is situated in the Temperate Mediterranean climatic and geographical zone. Three main climatic areas are defined for Turkey; Black Sea region with mild and rainy weather characteristics through the year, the southern and western coastlines with a typical Mediterranean climatic features, and finally, the central Anatolian part with cold dry winters and hot dry summers has a

semi-arid climate (Zinet, 2002). The central Anatolian region with a dry temperate climate covers a large area of Turkey. In other words, a large part of the country is under influence of dry temperate climatic conditions. Based on *Turkey Baseline Report on Climate Change* (2002), the mean temperature in the coldest month ranges from -3°C to 0°C and in hottest month of the year is reported between 20°C and 22°C. However, as Aksamija (2013, p.11) indicates, the Köppen Classification is often difficult for designers, instead, the ASHRAE classification is rather easier for retrofit project drivers. ASHRAE classification is developed with the cooperation of the International Energy Conservation Code (IECC) and the ASHRAE. The climatic zones are defined in eight groups and are numbered from 1 to 8 (1: very hot, 2: hot, 3: warm, 4: mixed, 5: cool, 6: cold, 7: very cold, and 8: subarctic). Each zone has also its humidity label (A: humid, B: dry, and C: marine). Based on ASHRAE classification Turkey is placed in the mixed-climate group (4), and the central Anatolian region is labeled as 4B (mixed-dry) climatic zone.

Building energy reduction projects in mixed climatic zones require combined actions in terms of acceptable solar exposure and adequate daylight receipts. On the one hand, appropriate solar control actions need to be implemented in order to distort the direct solar radiation in summer, on the other hand, passive heating substrates should be provided to collect solar heat gains in winter. In order to maximize daylight, large glazed façades along with the proper shading devices should be taken into account (Aksamija, 2013, p.14). In the next sections more details of required retrofit actions applicable in the mixed-dry climates are described.

### **Effective geometrical factors of the existing building on its energy performance**

Buildings with deep plan (compact forms) have the lowest surface area for heat loss, but usually, have the highest energy demands for artificial lighting and cooling demands and are less sensitive to orientation changes. In contrast, buildings with shallow plan have greater opportunities in embracing passive strategies, however, fitting in site and high façade costs are disadvantages of these types of built forms.



(Raji, Tenpierik, and van den Dobbelsteen, 2017). A tradeoff between deep and shallow plan building, is the atrium building. The covered atrium building despite admitting daylight, can have difficulties in terms of ventilation. Courtyard buildings by inviting daylight and natural ventilation to the center of the plan, account as building with a high passive ratio (King, 2009).

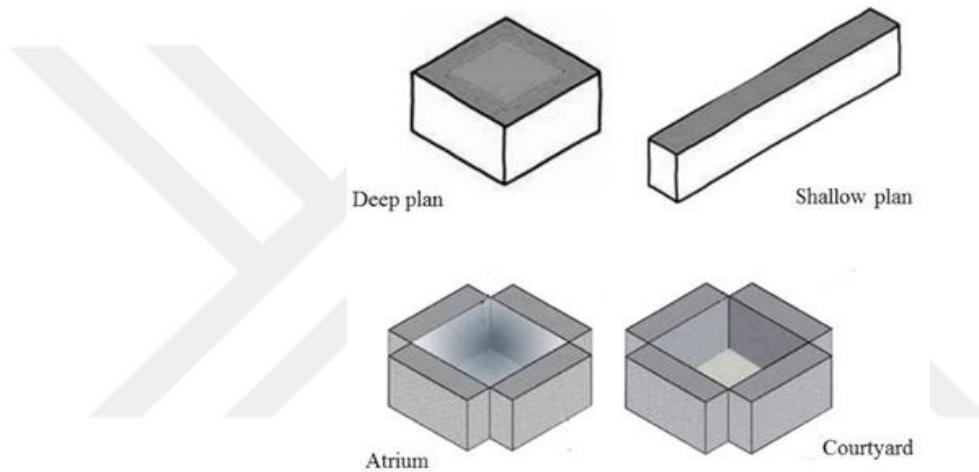

**Figure 4.3.** Considered four types of building shape in this thesis; deep, shallow, atrium, and courtyard.

According to Raji, Tenpierik, and van den Dobbelsteen (2017), in mixed climates, the most energy efficient built form for square plan shapes is the compact forms with the ratio of (1:1), which has the lowest heating and cooling demands. However, this form will have difficulties in admitting daylight and higher artificial lighting demands. Therefore, the 2:1 shape seems slightly better than the 1:1 shape. They found also shapes with plan ratio of 1:1 and 3:1 compared to the 2:1 will result a low increase (0.8%) in total energy consumption (Figure 4.4).

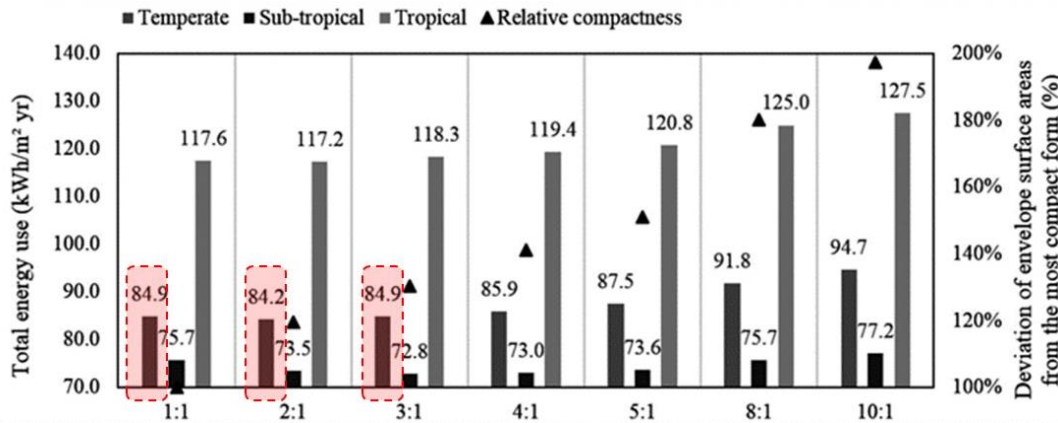

**Figure 4.4.** Total energy consumption for seven plan aspect ratios (Raji, et al., 2017).

From the overview of recent studies on the effect of basic geometry components including plan depth, plan aspect ratio, windows' orientation, and window-to-wall ratio (glazing ratio and distribution) on energy performance of buildings with shallow or deep plans in mixed climates, the building's optimal geometry properties can be highlighted as following (Raji, Tenpierik, and van den Dobbelsteen, 2017):

1. The effect of plan shape (circle, square, rectangular, etc.) on building energy consumption is the lowest in the mixed climate.
2. The effect of plan depth on total energy consumption is more dominant in the temperate climates. The more efficient plan depth ratio determined as 1:2, however, as a general range, this optimal ratio can be 1:1, 1:2, and 3:1.
3. Assuming that windows are equally distributed across building orientations, for a deep plan design, the optimal range of the window-to-wall ratio can be 20–30%. For a south-facing narrow plan (with no glazing) the cooling demands will be considerably increased.
4. The investigation also highlights the most sensitive orientations that potentially increase the total energy use (relative value) to a large extent for a wrong

selection of WWR in different climates; those include the west-facing exposure in mixed climates.

5. The optimal solar heat gain coefficient (SHGC) is 40% for mixed climates (Aksamija, 2013, p.16).
6. Solar heat gains in August month is in its high rates, which require appropriate solar heat protection like shading devices or low-e coated glazing (Aksamija, 2013, p.16).

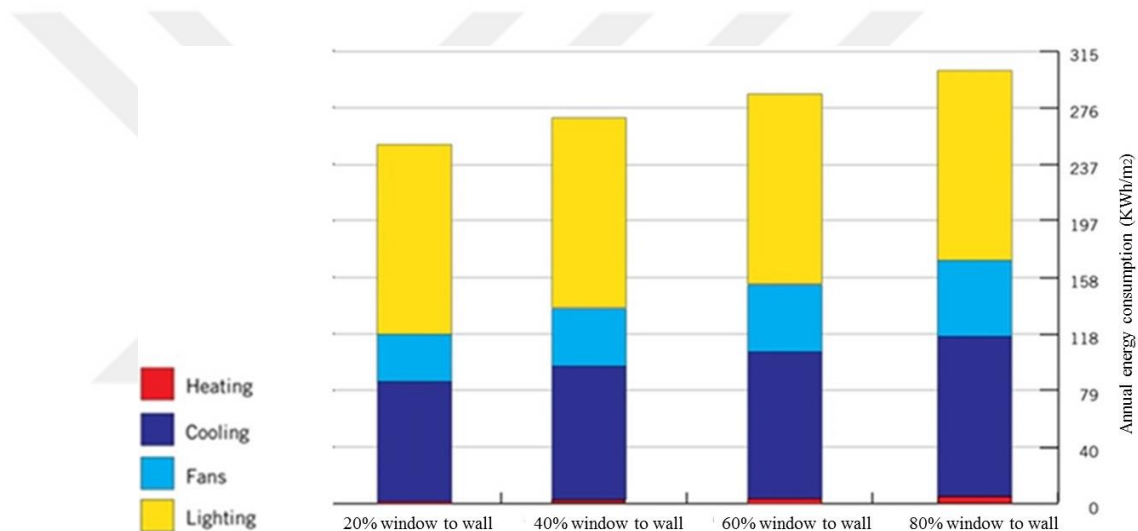

**Figure 4.5.** Effects of window-to-wall ratio for mixed, dry 4B climatic zones (Aksamija, 2013, p.22).

In mixed climates for both deep and shallow plans, an optimal window-to-wall ratio in terms of high energy efficiency is proposed by Raji, Tenpierik, and van den Dobbelen (2017) between 20% and 30% (due to lower heat transfer through the façade during winter and summer (Figure 4.5). Less than 20% WWR ratios refers to the high electrical lighting demands in building. The maximum WWR value in mixed climates can be 60% and upper values due to heat load transmittance will result more than 10% increase in building's total energy usage. Generally, due to the high

temperature differences between indoor and outdoor in temperate climates, building can have a limited range of WWR (min 20 < WWR < max 60).

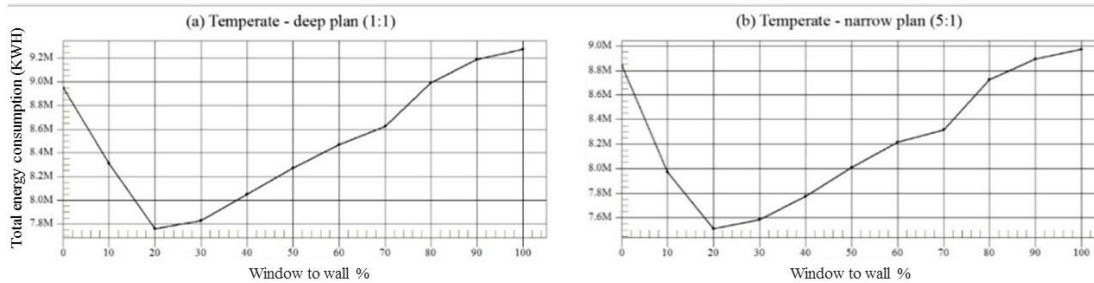

**Figure 4.6.** The optimal percentage of window-to-wall ratio for two plan types (1:1 and 5:1) in temperate climate (Raji, Tenpierik, and van den Dobbelen, 2017).

The recommended WWR values shows that for narrow (shallow) plan shapes, to prevent high cooling demands due to elongate north-south facing façade, both north and south facades should have low WWR ratios. Wrong decisions on choosing WWR in the south-facing façade in shallow plans are more risky than deep plans; in this situation, the increased cooling demands for narrow plans will be up to 68%, while this amount for deep plan buildings is 13%. A south façade always requires appropriate overhangs or fixed blinds and east or west façades need more dynamic ones. Electric lighting saving varies in two different interior parts of offices (peripheral and 2th row zones). Using automated or manually controlled blinds in southern façade, will save energy almost 50% to 60% in a peripheral office zone, however, electrical loads savings for centric parts that have not enough accessibilities to daylight (2th row zones) are usually low (Reinhart, 2002). The internal heat gains from occupancy, equipment, and electric lighting can reduce the heating demands in winter, however can also increase cooling demands in summer times (Raji, Tenpierik, and van den Dobbelen, 2017).

Numerous studies have indicated that the features of both courtyard and atrium building types affect the indoor environment conditions and comfort levels (Aldawoud, 2008; Abdullah, Meng, Zhao, and Wang, 2009; Aldawoud, 2013). The courtyard form can be fully enclosed (four sided), semi-enclosed (three sided) or in some cases even two sided (Meir, Pearlmutter & Etzion, 1995). The reviewed literature in this field clarifies the fact that the design form can be act as a microclimate modifier to the environment. Many researchers such as (Tablada et. al., 2005; Muhaisen and Gadi, 2006; Muhaisen, 2006; Aldawoud, 2008), have investigated the thermal performance of courtyard building with focusing on the influence of the geometrical variables of the courtyard on the amount of solar radiation gains. All these studies concluded that the form's surfaces need to be protected from intense solar gain and the hot dusty wind.

Muhaisen and Gadi (2006) studied the effect of a rectangular courtyard form at four different climates. Finding out the relationship between courtyard form, sun location, and shading performance was the main focus point. The results showed that the courtyard proportion and the received solar radiation, substantially, affect the heating and cooling demands. Due to the nature of the mixed climate, which is characterized by having two different seasons: a hot summer and a cold winter, deeper courtyard proportions are preferable in eliminating the cooling loads in summer and heating loads in winter. Deeper forms receive less amount of irradiation in summer that leads to minimum cooling loads and in winter less amount of heat losses (Figure 41-42). Generally, courtyard buildings because of their self-shading characteristics have lower rates of cooling demands in summer near 4%, however, in winter, it maximizes the heating loads by almost 12%. This reveals that gaining solar radiation in winter is more critical than preventing in summer and regarding the fact that shallower courtyard forms ( $R2=1$ ) have greater heating loads in winter times, the deeper forms ( $R2=0.1$ ) are most appropriate courtyard types for temperate climates. They carried out the study based on the varying ratios of  $R1$  and  $R2$ . The  $R1$  ( $P/H$ ) ratio represents the proportion of floor perimeters ( $p$ ) of courtyard to its height ( $H$ ) and refers to the depth of the related form. The range of this ratio is defined from 1 to 10. The elongation of the form is

represented by  $R_2$  variable, which indicates the ratio of the width of rectangular courtyard to its length ( $W/L$ ) and ranges from 0.1 to 1. Muhaisen (2006) proposed optimum courtyard height to perform rational in both periods of summer and winter for Rome as a temperate (mixed) climatic area. This optimum proportion based on the  $R_1$  and  $R_2$  variables, for summer times is proposed as  $R_1=1$  and  $R_2=0.1$  and for winter time, the optimum ratio is suggested as  $R_1=10$  and  $R_2=1$  (Figure 4.7).

In the case of existing buildings that changing the courtyard forms is not possible, authors proposed using light colors for the external surfaces and shading devices to deal with the overheating problems in summer. For winter times to block the heat losses improving the thermal properties of the opaque and glazed parts of façade is recommended that will be discussed in following sections (Safarzadeh, & Bahadori, 2005; Muhaisen and Gadi, 2006).

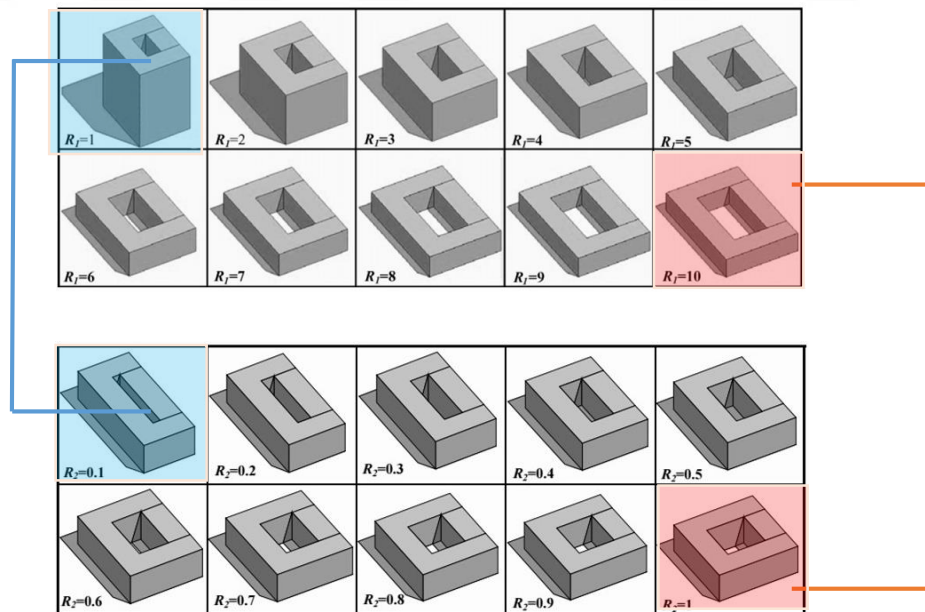

**Figure 4.7.** Above:  $R_1$  ratio, below:  $R_2$  ratio of rectangular courtyards in examining their energy consumption rates (Muhaisen and Gadi, 2006).

Aldawoud and Clark (2008) compared the energy performance of a central atrium with energy performance of a courtyard with the same physical properties (square plan) in four climatic zones of cold, temperate, hot-humid and hot-dry (Figure 4.8). They found that the open courtyard building acts better in terms of energy performance for the shorter buildings. As much as the increasing of the building height the enclosed atrium present a better energy performance.

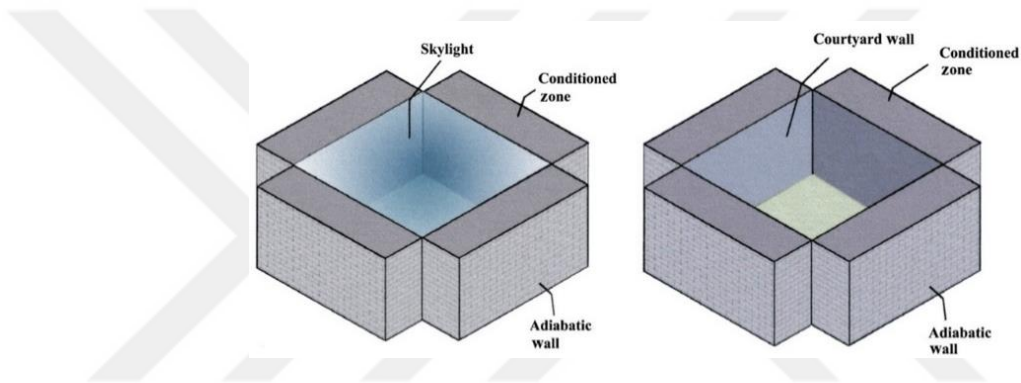

**Figure 4.8.** The models of atrium and courtyard (Aldawoud and Clark, 2008).

Existence of courtyards and atriums in buildings maximizes the internal passive zones of the building. It provides opportunities like, bringing light into the interior spaces, reducing lighting loads, self-shading and minimizing air conditioning loads. Despite all these benefits, the unpredictability of the courtyards' thermal performance requires reasonable retrofit actions to adjust and improve their energy performance. For existing buildings, considering energy conservation measures like, optimum window-to-wall ratio, double-glazed windows, adding insulation, interior blinds and sealing tapes are the points that have been referred by the scholars (Aldawoud, 2008; Aldawoud and Clark, 2008; Safarzadeh and Bahadori, 2005) in this field.

### **Window-to-wall ratio and glazing types in courtyards and atriums**

In a study by Aldawoud (2008), energy consumption of a courtyard in temperate climate, glazed with 30% surface area (ratio) and having double low-e glass was 40% lower than a courtyard's total energy consumption with single clear glass. For courtyards in temperate climate with glazing ratio of 67% at 10 floor height, the total energy consumption by implementing double clear glass reduced by 40% compared with single clear glazing courtyard. In case of having double low-e glass, energy consumption was 51% lower than single clear glazing. For triple clear glass, total energy consumption was lower by 54% than a single clear glazing courtyard. The results of a study by Tabesh and Sertyesilisik (2016), revealed that energy consumption of the courtyards with 40% window-to-wall proportions and triple glazing compared to the courtyards with 80% glazing ratio and single glazing type is considerably low for all climates of cold, temperate, and hot.

### **Integrated usage of courtyard and atrium**

Tabesh and Sertyesilisik (2016) studied how integrated usage of an atrium and courtyard can improve an office buildings' thermal performance. The context of their research was three cities of Erzurum, Istanbul, and Diyarbakir; representatives of respectively, cold, temperate, and hot climatic areas in Turkey. They found that using passive characteristics of courtyards and atrium, especially, their integrated usage can improve energy performance of the building. They have defined three usage patterns for different months of the year for each climate (Figure 4.9). They proposed an integrated usage of courtyard and atrium in order to achieve the optimum performance in all months of the year for each climatic zone. Accordingly, for Istanbul as the representation of the mixed climatic area, from May until mid-October, the courtyard state is more energy efficient for building, however, November till April, it needs to be covered with appropriate glazing types (single, double, or triple) and be prepared as an atrium mode.



Courtyard Is More Energy Efficient Compared to the Atrium			
City	Istanbul (mild and humid)	Erzurum (cold)	Diyarbakir (hot and dry)
Usage period	May until mid-Oct.	May until mid-Sept.	Apr. until Aug.
Atrium Is More Energy Efficient Compared to the Courtyard			
City	Istanbul (mild and humid)	Erzurum (cold)	Diyarbakir (hot and dry)
Single glazing on skylight	Nov. until Apr.	Oct. until Apr.	Apr. until July
Double glazing on skylight	Nov. until Apr.	Oct. until Apr.	Sept. until 15th Mar.
Triple glazing on skylight	Nov. until Apr.	Oct. until Apr.	Oct. until 15th Mar.

**Figure 4.9.** Integrated usage of courtyard / atrium (Tabesh & Sertyesilisik, 2016).

#### 4.2. Developing a Spatial Comfort Framework for Five Different Office Layouts

In this thesis, the targeted passive retrofit measures are those that improve both energy efficiency and indoor comfort quality. Accordingly, in order to achieve a holistic picture of the joint framework for both energy efficiency and high comfort quality, the interdependent relationships among building's form, façade condition, and interior spatial arrangements have been investigated. Reviewed literature revealed that establishing high comfort quality entails a substantial amount of energy consumption. Particularly, in the case of office buildings, providing high levels of indoor comfort quality comes to being more important than energy consumption concerns. This is because the fact that workers' comfort and wellbeing have a direct impact on their productivity at work and the loss of productivity means the loss of cost and investment of the organization. Thereupon, the conflict between high comfort quality and high energy demands becomes more prominent in office buildings. Accordingly, a firm tie between energy performance of the building and its indoor comfort should be established through the retrofitting process.

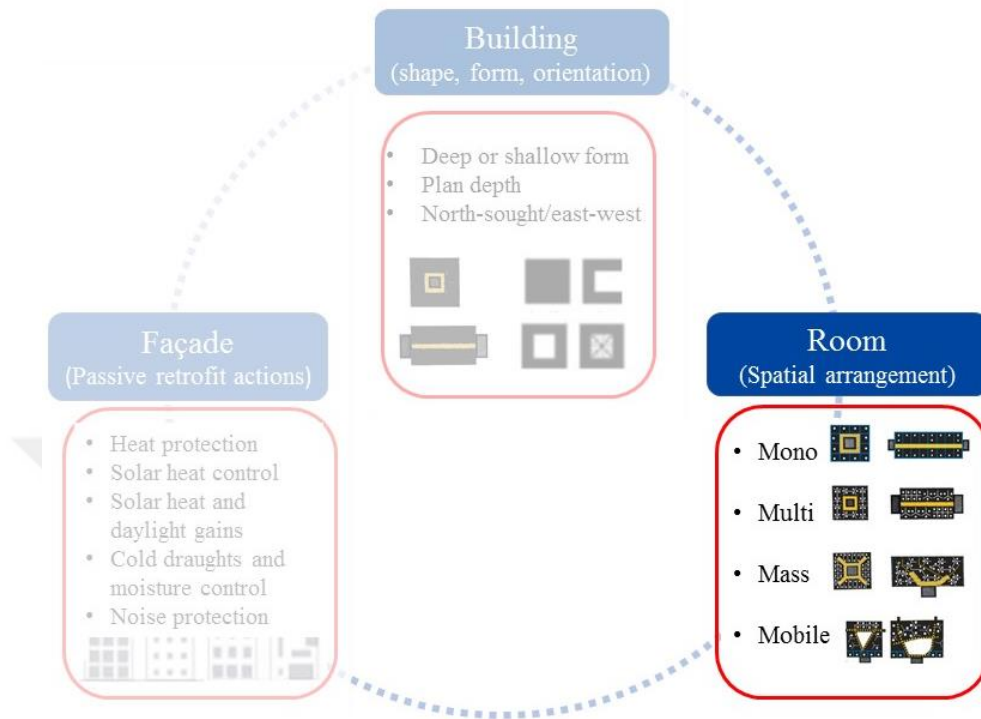

**Figure 4.10** Developing spatial comfort framework for five different office layouts

To answer the question of how the internal zones can benefit from the opportunities of the applied passive retrofit actions on the building façade, firstly, the internal zones should be clarified in terms of type, depth, and work pattern. As argued previously, different office organization, regarding its work style and requirements, have different interior spatial arrangements. Several typologies on defining spatial arrangements are represented by several researchers. However, this thesis has put its focus on Duffy’s office framework, which is substantially, more comprehensive than the rest. In this regard, to investigate the internal office potentials in benefiting from the applied passive retrofit actions on building’s façade, five different types of office spatial arrangements have been identified. These types named as, Mono, Multi, Mass-rigid, Mass-flex, and Mobile office types (Figure 4.11).

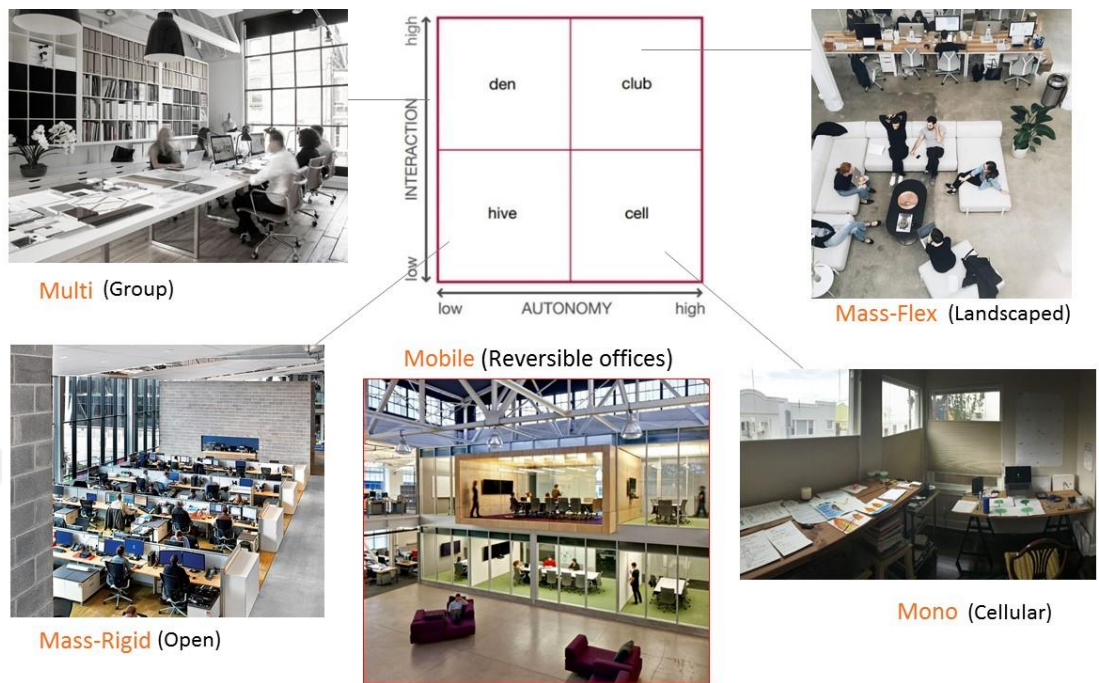

**Figure 4.11.** Considered five office plan type (based on central / sided core positions of Duffy's typology).

In the light of Duffy's framework, five classes have been identified to carry out the spatial comfort exploration in this thesis. Of these classes, four types are based on Duffy's category, which are the Cellular, the Group, the Open-plan, and the Landscape office, and one other type is added that describes the future reversible office concepts, called in this thesis as the Mobile type. All types are considered based on square plan shape with two states of core positions; central core or side core. In first state, core is located in the center of plan, which houses corridors' intersection zone usable by multiple workers. In the latter state, the core is located in one side of the plan and the center of plan is allocated again to circulation routs and multi-functional spaces. Accordingly, these five classes are Mono, Multi, Mass-rigid, Mass-flex, and Mobile. *Mono* attributes to the cellular office concept, *Multi* represents group office, *Mass-Rigid* represents open-plan office with rigid open arrangement of workstations, *Mass-Flex* represents landscaped office with flexible partitioned arrangement of

workstations, and finally, *Mobile* attributes to the reversible office concept with high autonomy and interaction working style. Following sections elaborate each layout type.

### **Mono office type**

The mono type represents a closed single office plan; an enclosed space with ceiling height, which separates interior space and work stations into private or semiprivate zones. From the view point of visual and audial privacy, this type account as a desirable option, however, prevents the sunlight absorption into the internal office spaces (Kim, 1999). The distraction, interruption, and cognitive stress levels are in lower rates in the closed and private office environments. Consistently, workers, who require high concentration, report complains of distractions in all layout types, except closed private offices (Seddigh, Berntson, Danielson and Westerlund, 2014). Mono office spaces with great accessibility to the passive zone, are in the subset of shallow-plan offices.

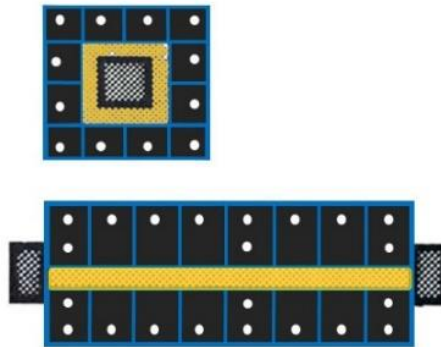

**Figure 4.12.** Mono office plan (based on central / sided core positions of Duffy's typology).

### **Comfort concerns in Mono offices**

As discussed in the literature review, these types of office building, are private and closed-plan rooms, which have a strong passive zone. These space types are mostly under the influence of façade performance. Although, all the occupants have adequate

accessibility to the windowed walls, but in the case of façade failure, they will be under the influence of discomfort problems related to the all thermal, visual, and audial domains. Despite the guaranteed visual privacy in enclosed private offices, acoustical privacy may not be able to achieve same satisfaction rates. This might be due to the using of the light-weight materials, lack of insulation, and improper construction approaches (Kim and de Dear, 2013).

### **Multi office type**

These types are shared open spaces for group working teams. The interaction level of the workers is along with separation elements. Typically, are medium-sized rooms containing 5-15 persons as team-workers. The proper depth of plan for these spaces is a little bit deeper compared to the cell offices and almost 15-20 meter depth is required. From the view point of spatial arrangements, group offices can be arranged in shallow and medium-depth plans, in some cases in deep plans (Duffy, Cave, and Worthington, 1976, p.81). The occupants of these office types have full or partial access to the windowed area and compared to the open deep offices have greater passive zone opportunities.

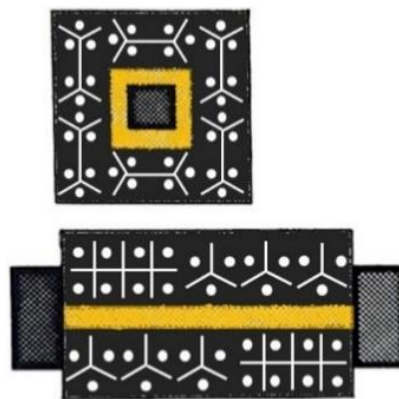

**Figure 4.13.** Multi office plan (based on central/sided core positions of Duffy's typology)

### **Mass-rigid office type**

Mass-rigid type represents a traditional open-plan office with a rigid arrangement of rows of workstations. As mentioned in previous sections, the open-plan office has become the dominant choice of workspace strategies, primarily, for economic reasons (Brill, Weidemann, and BOSTI Associates, 2001; Vischer, 1996; Brookes and Kaplan, 1972). Open offices with fewer interior walls allow larger group of employees to be accommodated (Vischer, 2005). Open-plan offices aid inter- and intra-team relations and more open workspace generates greater group sociability (Brookes and Kaplan, 1972). McElroy and Morrow (2010) conducted an experimental study on a retrofitted office project in which some employees were moved from a 1970s-style cubicle office environment to an open-plan office configuration. They realized that office retrofit actions (involving the combined use of brighter decor, new furniture, greater openness, and higher workspace density) resulted positive changes in employee's perceptions of organizational culture. The occupants of the retrofitted office find their new workplace more innovative, less formal, providing more professional control, greater co-worker satisfaction, and bringing up greater collaboration than their previous closed-plan work environment. However, despite all these positive changes, the workers of retrofitted office complained the degree of distraction due to the lack of personal spaces. As Brennan, Chugh, and Kline (2002) indicate, workers who have moved from conventional offices to open offices, usually, claimed feelings of physiological and psychological stress. Generally, distractions and lack of user control systems were the main reported dissatisfaction aspects by occupants.

The open plan layout is “more generic and less responsive to individual control” (Harrison, Wheeler, and Whitehead, 2004). Several studies have conducted on the investigation of the privacy, which is the outstanding difference between open-plan offices and closed plan offices. The studies on the benefits and risks of adopting an open-plan workspace strategy demonstrate the required attention towards the potential disadvantageous, such as increased distraction, noise, and reduced privacy (Leaman and Bordass, 2005; Smith-Jackson and Klein, 2009; Davis, Leach, and Clegg, 2010).

Kim, and de Dear (2013) found that generally, the positive impact of ease of interaction on user satisfaction was rated by occupant almost less than half of the unwanted impacts of noise, and visual privacy. This means that benefits of improved social interactions were smaller than the risks of decreased levels of visual and acoustical privacy resulting from openness of office configuration. The accessibility to the passive zone in this type of arrangement is not possible for all workstations. The internal zones have limited access to natural ventilation and daylight.

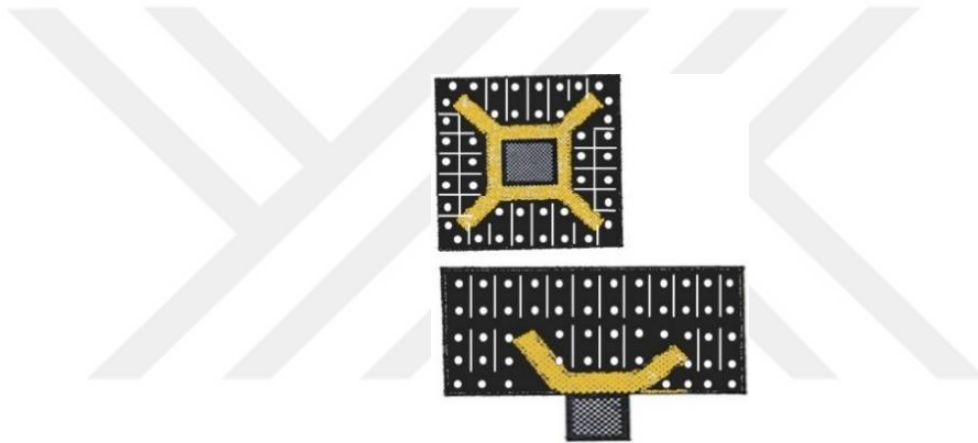

**Figure 4.14.** Mass-rigid office plan (based on central/sided core positions of Duffy’s typology)

### **Comfort concerns in Mass-rigid office types**

De Croon et al. claim that workplace openness eliminates user privacy and job satisfaction. Authors regarding the overload theory (Desor 1972; Oldham and Fried 1987) and privacy theory (Sundstrom et al. 1980), pointed out that open workplaces (without permanent or temporary partitions) and high-density offices have negative effects on workers in terms of concentration problems and the lack of acoustic and visual privacy. Accordingly, in the internal zones of Mass-rigid offices, the major discomfort problems attributed to the high rates of distractions and noise, the lack of daylight, outside view (in zones without access to windows), and low rates of visual privacy.

### Mass-flex office type

The concept of open landscaped office is named in this thesis as mass-flex office. As mentioned in previous sections, although landscaped office provides a rapid communication and optimum flexibility for arrangement and rearrangement of workstations (Palmer and Lewis, 1977), however, this layout type requires relatively deeper space which made this concept to not been desired as much as the other types (Duffy, Cave, and Worthington, 1976, p.82). Palmer and Lewis (1977) the writers of *Planning the Office Landscape*, in describing this type indicate that “office landscape concept is too often associated with open-plan office”. Although they are not interchangeable, but the required space depth for a landscaped office and for an open-plan office is same. Accordingly, in the proposed framework for spatial comfort section in this thesis, landscaped office is investigated as a subset of open-plan concept but with additional moveable and flexible partitions and interior screens. For this reason, the comfort issues of this type is investigated under the Mass-flex concept. Mass-Flex concept as a partitioned open plan work space, with shorter, temporary walls or partitions, simultaneously, increases privacy and spatial flexibility of the open space. Workers are able to adjust their visual privacy by means of separator screens and moveable partitions.

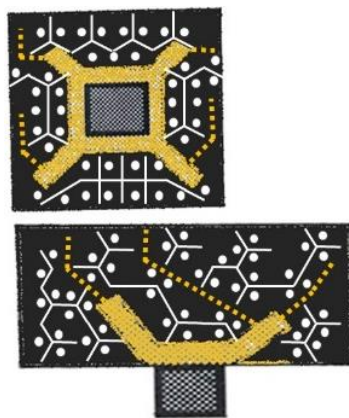
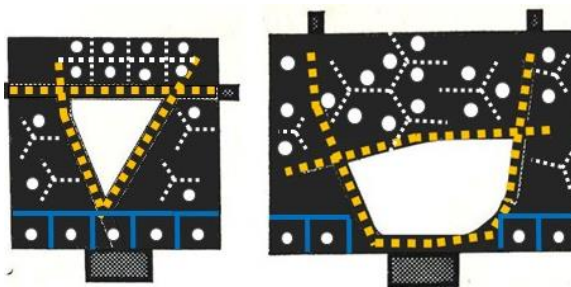

**Figure 4.15.** Mass-flex type office plan (based on Duffy’s typology).



## Mobile office type

Mobile type attributes to the offices mostly known as non-territorial workplaces. In several studies, it has been given various names like, reversible office (Pickardchilton, 2012), non-territorial office (Preiser and Vischer, 2005, p.149), and multi-space office (Schittich, 2011). Regarding spatial arrangement features, this concept comprises all types of office layouts; closed single offices, group zones, and open shared workstations. The major distinction aspect of this type is that autonomy and interaction level of workers are in very high levels and the defined work zone and working time boundaries are at very low level, sometimes, without any limitation. The spatial opportunities of communication, informal meeting and exchange spaces are improved with adjustable room sizes and the cluttered office spaces provide more convenient corporate working and motivational conditions. As Schittich (2011, p.13) describes, besides the mentioned interfused working zones, the main components of these offices are ergonomically beneficial meeting rooms, coffee bars, small lounge areas, think-tanks, and other communication zones. The work style of these offices is defined as diffusive work style (Preiser and Vischer, 2005, p.157). In a diffusive work style, workers can carry out their tasks in various workstations. Both autonomy and interaction levels are in their high levels.



**Figure 4.16.** Mobile type office plan (based on central/sided core positions of Duffy's typology).

## The impact area of passive retrofit actions within interior zones

Since, the aim of this thesis is developing passive retrofit framework for improving façade performance in existing office buildings, the impact area of the proposed façade retrofit framework needs to be clarified. It should be identified to what extent these actions are feasible for each type of the spatial organization. For this purpose, the passive zone ratio must be clarified. Passive zone (PZ) is defined as “the floor area of the building lying within a distance of twice the floor to ceiling height from the perimeter; and the PZ ratio is the proportion of passive zone to total floor area (Baker, 2009; Baker & Steemers, 2000).

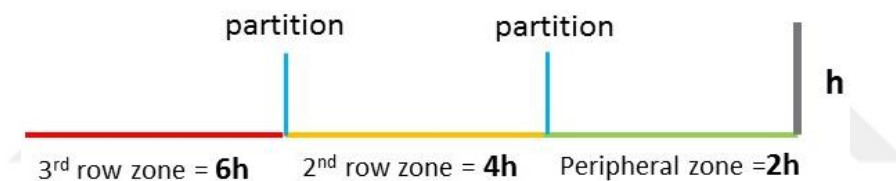

**Figure 4.17.** Passive zone ratio (Baker, 2009; Baker & Steemers, 2000).

In other words, passive zones in the interior parts of the building are areas near the window or the perimeter zones. Technically, these areas have the maximum possibility to be lit with daylight and naturally ventilated through windows. This zone is defined by researchers in various phrases, like, passive zones (King, 2009), peripheral offices, and 2<sup>nd</sup> row offices (Reinhart, 2002). Internal zones of the building that their lighting and air quality depend on the mechanical and electrical equipment is known as the active zone (King, 2009) or 3<sup>rd</sup> row offices (Reinhart, 2002) (Figure 4.18-4.19). The higher the ratio of passive to active areas, the better the total building energy performance will be.

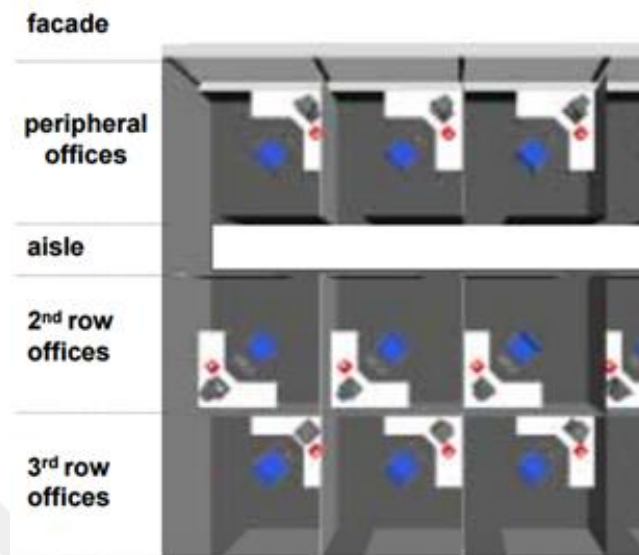

**Figure 4.18.** positions' of peripheral, 2nd row, and 3rd row office zones (Reinhart, 2002).

Accordingly, in terms of passive zone accessibilities in interior spaces, office indoor environment can be classified into internal (3<sup>rd</sup> row and 2<sup>nd</sup> row) zones and peripheral (perimeter-windowed-area) zones. Internal zones in deep plan buildings have minimum access to passive opportunities, thus, need to be lit artificially and ventilated mechanically. However, peripheral zones and, partially, 2<sup>nd</sup> row zones with a good access to windowed areas (passive zone) of the building, are latest to the natural daylight and ventilation opportunities (Duffy et al., 1976, p.145; Baker, 2009; and Reinhart, 2002). In the case of atrium buildings, both internal and peripheral zones have accessibility to passive zone.

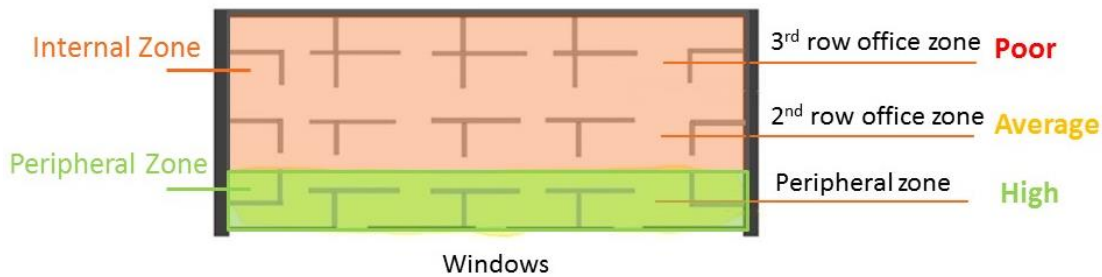

**Figure 4.19.** Peripheral zones (strong passive areas) and internal zones (partially passive areas) (based on Baker, 2009; King, 2009; and Reinhart, 2002).

For identifying the depth of passive zone in our five office typology, Duffy's space-depth classification (shallow, medium-depth, deep, and very deep) is taken into account. Following results can be drawn:

- Shallow plan spaces comprising cellular office arrangements have a passive zone (distance between circulation route to window wall) with the minimum and maximum space depth, respectively, from 4 m to 6 m.
- Medium-depth spaces have a passive zone (distance between circulation route to window wall) with the minimum and maximum space depth, respectively, from 6 m to 16 m.
- Deep spaces have a passive zone (distance between circulation route to window wall) with the minimum and maximum space depth, respectively, 11 m and 19 m.
- Very deep spaces have a passive zone (distance between circulation route to window wall) with an over 20 m space depth.

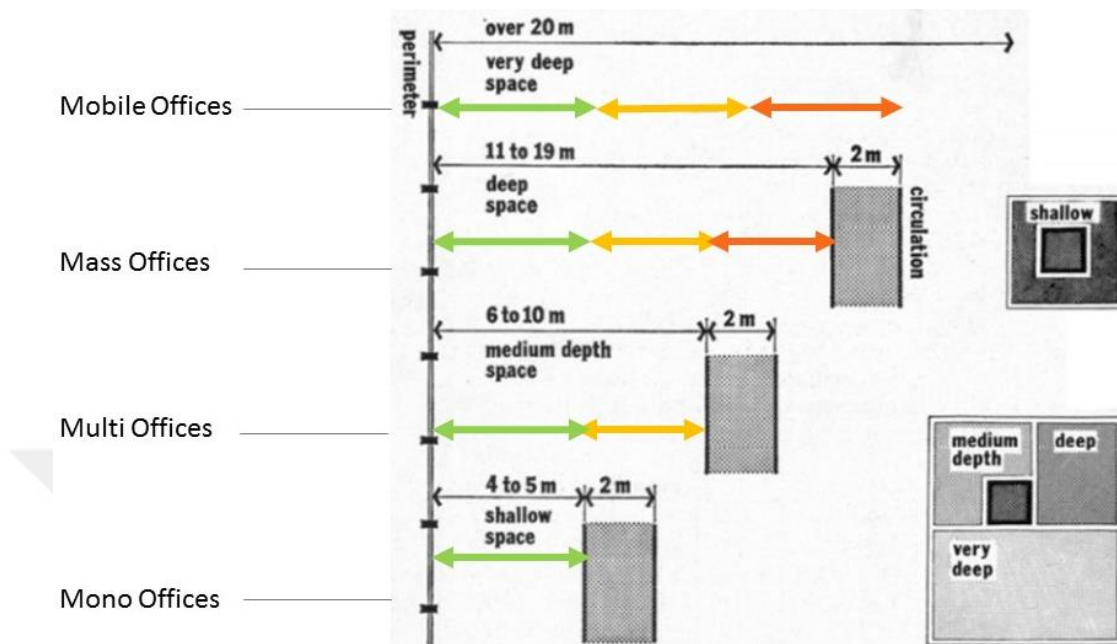

**Figure 4.20.** Passive zones in deep (above) and very deep spaces (below).

**Table 4.1.** Summarized Duffy's space depth dimensions and provided passive zone in each type (based on Duffy, Cave, and Worthington, 1976, pp.42-44).

Space depth	Shallow space	Medium-depth space	Deep space	Very deep space
Plan depth (core to perimeter walls)	6 – 8 m	8 – 18 m	13 – 19 m	Over 20 m
Passive zone-2 <sup>nd</sup> row depth	4 – 6 m	6 – 16 m	11 – 19 m	Over 20 m

Thereupon, by taking the plan-depth classification and the passive zone definitions into account, it is possible to identify that to what extent each of the five layout types encompasses peripheral and 2<sup>nd</sup> row zones and therefore, can access to the passive zone

opportunities. Mono office types have the greatest passive zone among the other types. Every enclosed private offices are arranged near the windowed area. Furthermore, their passive zone is peripheral. Multi office types encompass both individual and group workstations and can be arranged within both shallow and medium-depth spaces. Their spatial arrangement can encompass both peripheral and 2<sup>nd</sup> row zones. Mass-Rigid and Mass-Flex office types as open plan offices, as mentioned previously, need to be arranged in deep spaces, consisting of three zone types of peripheral, 2<sup>nd</sup> row, and 3<sup>rd</sup> row zones. Mobile office types with their flexible spatial arrangements consist of different layouts and, consequently, varied depth of spaces. Similar to the Mass-Rigid, and Mass-Flex office types, Mobile office types encompass passive zones in three levels of peripheral, 2<sup>nd</sup> row, and 3<sup>rd</sup> row zones. Regarding the aim of this thesis in developing passive retrofit framework for improving façade performance in existing office buildings, the impact area of the proposed framework is mainly on the peripheral and 2<sup>nd</sup> row office environments, which are known as passive zones. The internal office zones have lower opportunities in receiving the advantageous of the passive design outputs. According to the passive zone ratio of each plan type and the related spatial arrangement, it can be concluded that the most responsive office type for the proposed retrofit framework is first, Mono office types with low plan depth and high passive zone ration. Despite their high latent to the passive opportunities, workers have more flexibility than other office types in adjusting their comfort conditions. Mobile office types set at the second plan after Mono offices in terms of their responsiveness to the framework. Although Mobile offices are the most flexible type in terms of both autonomy and interaction, however, they need a substantial floor area, which may not be possible for all office organizations.

Table 4.2 illustrates a summary of reviewed details and information regarding all the five office typology of this thesis.

**Table 4.2.** Spatial arrangement details for five different office layouts (by the author, based on literature review).

Office Spatial Arrangement Typology		Mono office	Multi Office	Mass-Rigid Office	Mass-Flex Office	Mobile Office	Source
Image							Images by author based on Duffy's plan depth and core position
Traditional Typology Name	Cellular	Group	Open-plan	Landscaped	Reversible		Duffy, 1999) / (Pickardchilton, 2012)
Duffy's Typology Equivalent	Cell	Den	Hive	Club	Not defined		(Duffy and Powell, 1997) / (Stratton, 1997)
Average Workplace Per Person	10 - 16 m <sup>2</sup>	12 - 15 m <sup>2</sup>	12 - 15 m <sup>2</sup>	12 - 15 m <sup>2</sup>	8 - 15 m <sup>2</sup>		(Duffy, Cave & Worthington, 1976) / (Reinhart, 2002) / (King, 2009)
Plan Architecture	Shallow plan	Shallow or medium-depth	Deep	Deep	Deep or very deep		
Zone Enclosure	Enclosed	Semi-enclosed or open	Open	Open	Enclosed, semi-enclosed, and open		
Zone Type	Peripheral	Peripheral / 2nd row	Peripheral / 2nd & 3rd row	Peripheral / 2nd & 3rd row	Peripheral / 2nd & 3rd row		
Plan Depth (core to perimeter walls)	min 6 - max 8 m	min 6 - max 18 m	min 13 - max 19 m	min 13 - max 19 m	min 13 - > 20 m		(Duffy, Cave & Worthington, 1976)
Passive Zone Depth	min 4 - max 6 m	min 4 - max 16 m	min 11 - max 19 m	min 11 - max 19 m	min 11 - > 20 m		
Accessibility Proportion to Passive Zone	100%	75%	40%	40%	75 - 100 %		(PickardChilton, 2012)
Work Pattern	Individual work	Group work or teamwork	Individual work	Individual and Group work	Diffusive or flex-functional work		
Interaction Level	Medium to low	Medium to high	Medium to low	Medium to high	Changeable / Context dependent		(Duffy and Powell, 1997) / (British Council for Offices, 2005)
Autonomy Level	Medium to high	Medium to low	Medium to low	Medium to high	high		
Work Concentration Level	High	Medium	Low	Medium	Changeable / Context dependent		(PickardChilton, 2012)
Privacy	High	Medium	Low	Low to medium	High / Changeable		(Stratton, 1997)
Control of Climatic Factors	Individual	Individual / Automatic	Automatic	Automatic	Individual / Automatic		(PickardChilton, 2012)

#### **4.2.1. Spatial comfort framework for peripheral and internal office zones**

This section, firstly, discusses the steps of the generating the energy retrofit framework, considering spatial re-arrangements, which is comprised of viable alternatives for distinct problems that can be used by decision maker in the initial steps of the retrofit process to achieve a general knowledge about different alternatives for each problem. As mentioned in previous chapter, the indoor environment is under influence of the several variables and comfort triggers. In this thesis three fundamental comfort domains, which are affected by building façade performance are considered: thermal comfort, daylight, and acoustic comfort. This is consistent with research revealing that these categories account by occupants as the most important factors in distinguishing the comfort level of the space (Al horr et al., 2016).

As Table 4.3 shows, the comfort framework is defined in a hierarchical structure comprised of six levels of “discomfort problem”, “main goal”, “comfort domains”, “comfort criteria”, “performance criteria”, and “performance options”. The problem is placed at the top level, followed by the specific goal in the frame of one of the three domains of comfort, which are contributed to the related comfort indicators, each indicator is extended to a number of performance criteria that are finally specified by one or more recommended performance options. This kind of formalization helps the user to reach a set of viable performance recommendations as solutions to the existing problems. Accordingly, for a set of distinct spatial discomfort problems, related actions and their possible options are proposed. The detailed information is illustrated in the Table 4.3 and the problem-solution framework for peripheral and internal office zones are illustrated, respectively, in Table 4.4 and Table 4.5.



**Table 4.3.** Hierarchical structure of performance framework (by the author).

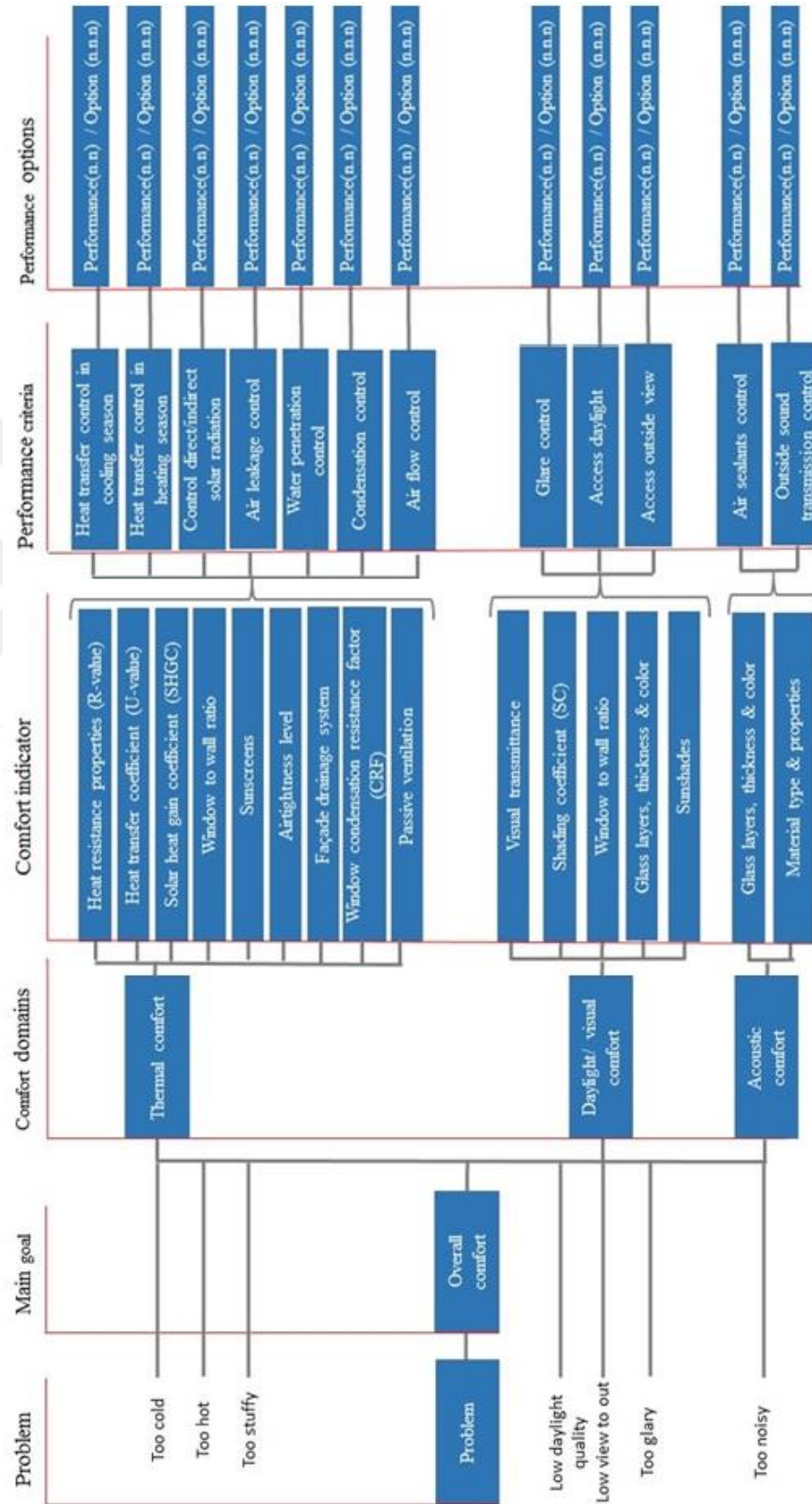

**Table 4.4.** Spatial comfort framework for peripheral office zones (by the author).

Discomfort Source	Main Goal	Spatial Comfort Indicator	Spatial Comfort No.	Spatial Performance Criteria	Performance	Standard Requirements	Source
<b>Spatial Arrangement: Peripheral Zones of All Arrangement Types</b>							
Downdrafts	Low air flows from outside	Preventing cold flows penetration	SC.1.	Reducing penetration of cold downdrafts	<p>SC.1.1. Decreasing the height of windows</p> <p>SC.1.2. Improving window U-value &amp; sealants: refer to TC.9.1, and TC.15.</p> <p>SC.1.3. Using low-e coatings and window storm panels: refer to TC.5.</p> <p>SC.1.4. Placing the radiators on the external walls</p>	Acceptable resultant temperature (mean radiant temperature) in winter: 19°C -23°C and in summer: 20°C - 24°C The average temperature range: 20 and 26 °C Temperatures above 35 °C are not permitted.	Petermann and Menchaca, 2017  (Duffy, et.al., 1988, pp.143-144)/ (Hoffmann, et.al., 2012)
				Reducing cold radiation effect on occupants near the windows	<p>SC.2.1. Reducing total amount of glazing</p> <p>SC.2.2. Increasing the sill height</p> <p>SC.2.3. Improving the glazing performance if percent glazing is high: refer to TC.3, &amp; TC.4.</p> <p>SC.2.4. Using low-e coatings on room-side glazing: refer to TC.5.2.</p> <p>SC.2.5. Redirecting extracted heat of artificial light from the internal parts to peripheral area</p>		Petermann and Menchaca, 2017  (Berardi, 2015) /ASHRAE, 2001b, chapter 30/ (Harvey, 2012, pp.70-72)/ (Hollands et al., 2001)  (Duffy, et.al., 1988, p.146)
Cold Radiant	Optimum air flows	Providing air movement	SC.3.	Providing indirect airflows in winter	<p>SC.3.1. Using small openings at high level</p> <p>SC.3.2. Reducing thermal radiation of heated room surfaces</p> <p>SC.3.3. Using high admittance surfaces</p> <p>SC.3.4. Using partially open windows as winter ventilators</p>	Acceptable opening area for passive ventilation: at least 5% of the floor area Acceptable opening area for smoking relief: at least 2.5% of the floor area	(Duffy, et.al., 1988, p.144)/  (Kelles, 1972)  (Søndergaard, Morten, Hansen & DELTA, 2017)
				Providing natural ventilation in summer	SC.4.1. Using large openings at lower level on several walls		(Duffy, et.al., 1988, p.144)/
Too Hot	Optimum Humidity Quality	Providing acceptable humidity rates	SC.5.	Increasing relative humidity	SC.5.1. Using anti-static spray-on coatings in case of dry interior space	Acceptable humidity percentage for a normal office with average temperature of 20°C :40-70 %	(Duffy, et.al., 1988, p.142)
				Reducing vertical temperature gradients			(Duffy, et.al., 1988, p.143)
Too Stuffy	Low direct gains	Providing glare-free daylight	SC.7.	Optimizing external glazed percentage in peak solar radiation hours	<p>SC.7.1. Using internal controls: refer to section TC.6.5 in first framework</p> <p>SC.7.2. Using External controls: refer to TC.6.4 in first framework</p> <p>SC.7.3. Using automated or manually controlled blinds in southern façade</p>	Increase in temperature per meter in height of room: less than 1.5 °C minimum illumination for office space: 500 lux	(Reinhart, 2002)
				High acoustical privacy	<p>SC.8.1. Adding acoustical absorber baffles in inlet &amp; outlet vents in airflowducts</p> <p>SC.8.2. Using attenuated vent openings</p> <p>SC.8.3. Using attenuated double windows</p> <p>SC.8.4. Adding external attenuator connected to the window</p>		<p>Maximum relative loudness of space (Noise Criteria, NC): Large open office: NC 40-45 Secretarial /drawing office: NC 50</p>
Too Glare	Too Stuffy	Too Noisy					

**Table 4.5.** Spatial comfort framework for internal office zones (by the author).

Discomfort Source	Main Goal	Spatial Comfort Indicator	Spatial Comfort No.	Spatial Performance Criteria	Performance	Standard Requirements	Source
<b>Spatial Arrangement: Internal Zones of All Arrangement Types</b>							
Too Hot	Optimum thermal quality		SC.9.	Reducing artificial lighting heat loads	SC.9.1. Extracting warm air through lighting fittings SC.9.2. Applying displacement ventilation	Acceptable resultant temperature (mean radiant temperature) in winter: 19°C -23°C and in summer: 20°C - 24°C	(Duffy, et.al., 1988, p.146) Shahzad, Brennan, Theodossopoulos, Hughes, & Calautit, 2015
				Providing cool supply air flows	SC.10.1. Applying cross-flow ventilation SC.10.2. Using displacement ventilation + openable windows SC.10.3. Using combined supply-extract ceiling diffusers SC.10.4. Dividing office space into supply and extract zones SC.10.5. Placing ceiling supply-extract air diffusers closely		The average temperature range: 20 and 26 °C Temperatures above 35 °C are not permitted.
Too Cold	High visual quality		SC.11.	Reflecting heat into the space	SC.11.1. Extracting warm air through the space above the ceiling	minimum illumination for office space: 500 lux	(Duffy, et.al., 1988, p.146)
Too Dimmed				Increasing the impact range of natural daylight in internal office zones	SC.12.1. Reducing partitions' height SC.12.2. Slopped down ceilings for rooms with smaller vision areas SC.12.3. Using light-directing pipes, refer to VC.2 and VC.3 sections SC.12.4. Adding desk lamps or dimmer switches		(reinhart, 2002) / (Schittich, 2011, p.42) / (Aksamija, 2013, p.60)
Too Noisy	Increasing audial comfort	Low relative loudness of space	SC.13.	Reducing internal reflection of sound	SC.13.1. Separating zones based on noise and work patterns SC.13.2. Providing buffer zones SC.13.3. Using high sound-absorbing ceiling SC.13.4. Providing carpeted floors SC.13.5. Masking internal noise SC.13.6. Using higher panels to separate teamwork zones SC.13.7. Using movable and divider partitions SC.13.8. Adding free-standing sound absorbent partitions	Maximum relative loudness of space (Noise Criteria, NC): Large open office: NC 40-45 Secretarial /drawing office: NC 50	(Duffy, et.al., 1988, pp.133-139)/ (Harvey, 2012, pp.224-225) / (Zhang, Kang, and Jiao, 2012)/ (Reinhart, 2002) / (Vischer, 1989)/ (Passero, & Zannin, 2012)
Visual & Daylight Obstruction					Increasing visual comfort		SC.14. Reducing visual obstructions around the workstations SC.15. Increasing daylight
Low Sense of Visual Privacy	Personality		SC.16.	Increasing the degree of enclosure	SC.16.1. Providing more partitions with optimum height		(Kim, & de Dear, 2013)/ (Maher and von Hippel, 2005)
Low Sense of Personality				SC.17. Incorporating colour in workstations	SC.17.1. Incorporating color in workstations SC.17.2. Adding different colours to different workstations		(Schittich, 2011, p.42) / (Duffy, et.al., 1988, p.145)

### 4.3. Effective Passive Retrofitting Actions on Existing Façade System in Mixed-Dry Climates: Façade Scale

As discussed previously, the comfort quality in offices is broken down into relevant performance criteria in the frame of three main categories of thermal comfort, daylight, and acoustic comfort. All these three categories are investigated individually for three non-load bearing façade systems; single-skin cladded façades, single-skin glazed façades (curtain walls), and double-skin façades. The proposed passive interventions in the façade retrofit framework for this thesis are presented upon seven strategies, 1) reducing heat loss in winter, 2) reducing overheating in summer, 3) providing natural ventilation, 4) increasing daylight opportunities, 5) reducing glare effects, 6) reducing stuffiness, and 7) reducing external and internal noise.

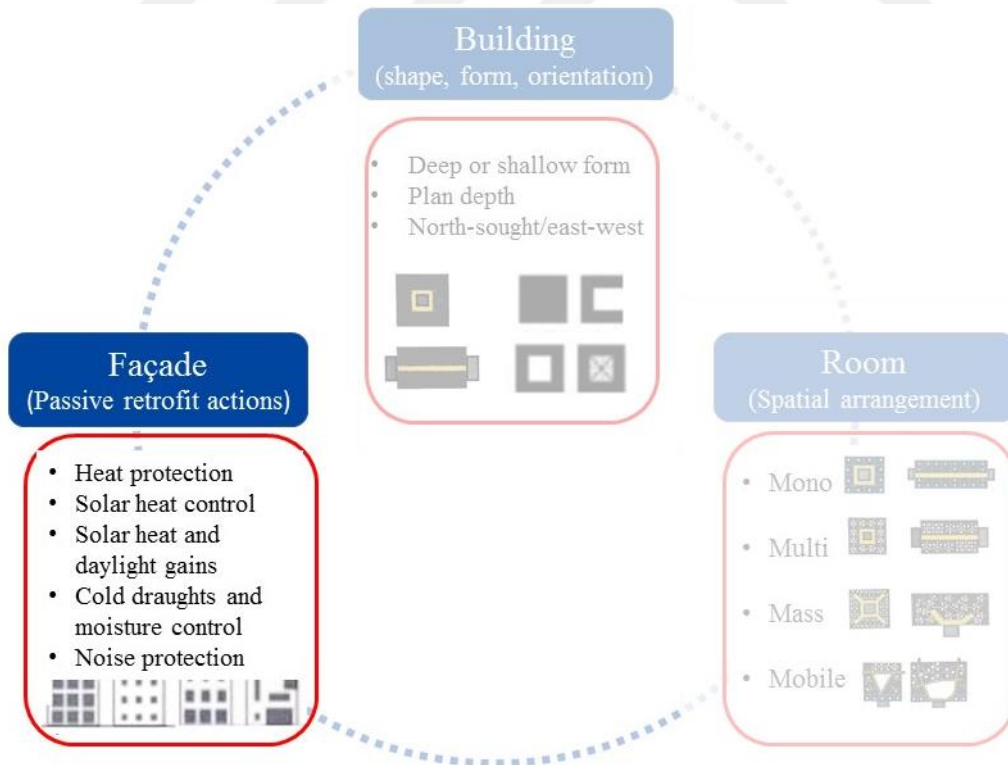

Figure 4.21. Passive retrofitting criteria applicable on existing façade system (author).

### **4.3.1. Façade Retrofit Framework**

The followed steps in developing the façade retrofit framework is in the same hierarchy and structure of the spatial comfort framework. This framework divides the comfort subject into three smaller parts and analyzes the contribution of each part to the whole problem. This process reduces the complexity of the subject for different stakeholders. According to Saaty (1972), a hierarchical frame simulates the intrinsic operation style of the human mind. Particularly, when faces with multi-criteria complex subject, the mind begins to classify them into groups based on certain features they share with together. Structuring the criteria helps to create a basis for formal assessment of the problem, while all related objective and subjective factors are taken into consideration.

As shown, on the one hand, some comfort indicators are very common among the performance criteria, such as R-value, U-value, and glazing type and layers. On the other hand, some of them are in a strong conflict with each other, and some of them have a supplement relations, which strength the performance in solving the problem. Environmental quality in office buildings is defined as the existence of thermal comfort, indoor air quality, lighting and acoustic comfort, and avoidance of performance attenuation in the working process of office occupants (Reffat and Harkness, 2001).

Table 4.6 represents the proposed actions for three façade types to deal with thermal discomfort problems, Table 4.7 represents the proposed actions to deal with visual discomfort problems, and finally, Table 4.8 illustrates the viable retrofit actions to avoid audial problems, respectively.

**Table 4.6.** Façade retrofit framework for improving thermal comfort (by the author).

Discomfort Source	Main Goal	Thermal Comfort Indicator	Thermal Comfort No.	Thermal Performance Criteria	Performance	Option No.	Source
Single skin cladded façades (discontinuous windows)							
Too hot, Too cold	Low thermal conduction	High thermal resistant (R-value) of claddings	TC.1.	Reducing heat transfer by using high thermal resistant cladding materials	TC.1.1. Using nonstructural masonry cladding materials	TC.1.1.1. clay- or concrete-based brick veneer cladding	(Aksamija, 2013)
					TC.1.2. Using metal-based cladding materials	TC.1.2.1. Colour-coated steel and aluminium	(www.ruukki.com)
			TC.2.	Reducing heat transfer by using thermally insulated panels	TC.2.1. Using insulaiton integrated opaque panels	TC.2.1.1. Fiber reinforced polymers (FRPs) panels or	(Berardi & Dembsey, 2015)/ (Trubiano, 2013)
					TC.2.2. Using panels with translucent insulation materials (TIMs)	TC.2.2.1. Aerogel-filled multi wall polycarbonate panels	(Trubiano, 2013) / (Moretti, et al., 2017)
TC.2.3.	Using insulating concrete units	TC.2.3.1. Thin-shell precast concrete panels	TC.2.3.2. Insulated concrete forms (ICFs) or blocks (ICBs)	(Aksamija, 2013)			
Too hot, Too cold	Low heat transfer	Low heat transfer coefficient of windows (U-value, W/m <sup>2</sup> /K)	TC.3.	Reducing conductive & convective heat transfer through the glass panes	TC.3.1. Using multipane glazing system	TC.3.1.1. Double- or triple-glazed windows	(Harvey, 2012)
					TC.3.2. Using gass-filled windows	TC.3.2.1. Argon- or Krypton-or filled windows	
					TC.3.3. Using insulated glazing units	TC.3.3.1. vacuum-insulated windows + hard low-e coatings	(Harvey, 2012)/ (Muneer et al, 2000)
					TC.3.4. Using transparent insulation for inclined windows and skylights	TC.3.4.1. Silica aerogel layers	(Berardi, 2015) / (Harvey, 2012, p.85)
		TC.4.	Reducing conductive heat transfer through the frame	Using insulated framing materials and spacers (between the panes of galls within the frame)	TC.4.1. Using insulated framing materials and spacers (between the panes of galls within the frame)	TC.4.1.1. Thermally broken aluminum frames	(Harvey, 2012) / (ASHRAE, 2001b, chapter 30)
						TC.4.1.2. Coated aluminum cladding frames	(Harvey, 2012), (www.westekwindows.com)
						TC.4.1.3. Incorporating the frame into the insulated wall	(Harvey, 2012) / (Bredsdorff et al., 1998)
						TC.4.1.4. Silica aerogel spacers	(Harvey, 2012) / (ASHRAE, 2001b, chapter 30)
TC.4.2.	Using composite frames (for maximum insulating)	Using composite frames (for maximum insulating)	TC.4.2.1. Aluminum-clad wood frames	TC.4.1.5. Pultruded fibreglass frames	(Harvey, 2012) / (CADET, 1999) / (ASHRAE, 2001b,		
				TC.4.2.2. vinyl frames / vinyl-clad wood frames	(Harvey, 2012)		
							(Harvey, 2012, p.85) (www.quakerwindows.com)

Too cold	Low heat loss		TC.5.	Reducing heat loss by eliminating the emission of infrared (IR) radiation (from window to outside)	TC.5.1. Using low-emissivity coatings (low-e or heat-mirror windows)	TC.5.1.1. Soft and hard low-e films	(Harvey, 2012), (Hollands et al, 2001)
					TC.5.2. Applying low-e coatings to the inner surface of the inner glazing	TC.5.2.1. Adding a coating on surfaces #3	(Harvey, 2012, pp.70-72)
					TC.5.3. Using interior window coverings	TC.5.3.1. Adding interior storm panels on windows	(Hollands et al., 2001)
					TC.5.4. Using exterior storm window coverings	TC.5.3.2. Using mid-pane blinds	(US department of Energy) / (efficientwindowcoverings.org) / (http://www.sunshadeblindssystem.co.uk)
Too hot / overheating	Low heat gain	Low Solar Heat Gain Coefficient (SHGC)	TC.6.	Reducing heat penetration from window by blocking the heat transfer from window to interior (controlling direct solar radiation)	TC.6.1. Applying low-e coatings on the inner side of the outer glazing of double- or triple-glazed windows	TC.6.1.1. Applying low-e coating on the surface #2	(Harvey, 2012, p.76) (Selkowitz, 2010) / (www.metroglass.co.nz)
					TC.6.2. Using reflective films on east and west facing facades	TC.6.1.2. Using flippable windows with low-e coating	(Feuermann & Novoplansky, 1998)
					TC.6.3. Providing self-shade building skin	TC.6.2.1. Using silver mirror-like films (transparent)	US department of Energy
					TC.6.4. Using exterior shading devices	TC.6.2.2. Spectrally selective low-e coated glazing units	<a href="http://windows.lbl.gov">windows.lbl.gov</a>
Too hot / overheating	Low heat gain	Low Solar Heat Gain Coefficient (SHGC)	TC.7.	Reducing solar heat transmission through the window panes (controlling indirect solar radiations)	TC.6.4. Using exterior shading devices	TC.6.4.1. Using mesh window screens	<a href="http://www.energy.gov">www.energy.gov</a>
					TC.6.4.2. Horizontal and adjustable shading devices on south facade	TC.6.4.3. Vertical and adjustable shading devices on west, east, and north facing facades	<a href="https://www.weinor.com/awnings/">https://www.weinor.com/awnings/</a>
					TC.6.4.4. Exterior fixed egg-crate shading boxes (combination of horizontal & vertical shadings)	TC.6.4.5. Using fritted glass louvers	(US department of Energy) / (www.wbdg.org) / (www.greenglobes.com) / (Stevens, 1998) / (Vassigh & Chandler, 2012)
					TC.6.4.6. Adding roller shutters on external side of the existing windows	TC.6.5. Using light coloured and open weave fabric interior shading devices	(US department of Energy) / (Stevens, 1998) / (energy.gov; baliblinds.com) / (windows.lbl.gov) / (http://www.sunshadeblindssystem.co.uk)
Too hot / overheating	Low heat gain	Low Solar Heat Gain Coefficient (SHGC)	TC.7.	Reducing solar heat transmission through the window panes (controlling indirect solar radiations)	TC.6.5.1. Venetian blinds (durable & economic)	TC.6.5.2. Vertical louverd blinds	(US department of Energy) / (Stevens, 1998) / (energy.gov; baliblinds.com) / (windows.lbl.gov) / (http://www.sunshadeblindssystem.co.uk)
					TC.6.5.2. Vertical louverd blinds	TC.6.5.3. Roller blinds	
					TC.6.5.3. Roller blinds	TC.6.5.4. Adjustable Cellular shades	
					TC.6.5.4. Adjustable Cellular shades	TC.6.5.5. Using mid-pane blinds	
Too hot / overheating	Low heat gain	Low Solar Heat Gain Coefficient (SHGC)	TC.7.	Reducing solar heat transmission through the window panes (controlling indirect solar radiations)	TC.7.1. Using glazing systems with high visible transmittance and low NIR transmittance	TC.7.1.1. Using switchable low-e glass coatings	(Harvey, 2012, pp.73-76) (Rosencrantz et al, 2005)
					TC.7.2. Synchronizing the solar transmissivity with	TC.7.1.2. Using high-iron glass	
					TC.7.3. Using Insulated glazing systems	TC.7.2.1. Using angular-selective thin films	(Granqvist, 2003)
					TC.7.4. Using triple insulated glazing systems	TC.7.3.1. Using Electrochromic glass	(Aksamija, 2013) (US department of energy)
Too hot / overheating	Low heat gain	Low Solar Heat Gain Coefficient (SHGC)	TC.7.	Reducing solar heat transmission through the window panes (controlling indirect solar radiations)	TC.7.3.2. Using Spectrally selective double-lite air-insulated low-e glazing	TC.7.3.3. Using Aerogel-field or Vaccum insulated glazing unit	(Dowson, Harrison, Craig & Gill, 2011) / SCHULTZ, JENSEN, & KRISTIANSEN, 2005)
					TC.7.4.1. Triple-lite air-insulated clear or low-e coated glazing units	TC.7.4.3. Triple insulated glazing units integrated with PCMs (as a passive heat source)	(Aksamija, 2013)

Too hot summers + too cold winters	Low heat gain in summer + high heat gain in winter	Optimum trade-off between U-value, SHGC factor and access to daylight	TC.8. Reducing both winter heating loads and summer cooling loads (balancing heating & cooling requirements)	TC.8.1. Using windows with lower U-value and lower SHGC	TC.8.1.1. Spectrally selective low-e coated glazing units	<a href="http://www.energy.gov">www.energy.gov</a>
					TC.8.1.2. Silica aerogel layers between window panes in double-glazed windows	(Harvey, 2012, p.85)
					TC.8.1.3. Using triple-glazed windows with multiple low-e coatings	(Harvey, 2012, p.82) / (Brunger et al, 1999)
				TC.8.2. Using windows with lower U-value and larger SHGC in south facade (in heating dominated climates)	TC.8.2.1. Using motorised shading devices and roof overhangs for summer time (solar radiation level is low in summer time at south facades)	(Harvey, 2012, pp.78-79) (Carmody et al., 2004)
					TC.8.2.2. Adding low-e coating on surface #3 in a double-glazed window	(Harvey, 2012, pp.78-79)
					TC.8.2.3. Using low-iron glass types	(Henry and Dubrous, 1998)
		TC.8.2.4. Using vacuum insulated windows	(Harvey, 2012, pp.78-79)			
Too cold	Low air flows from outside	Air leakage control	TC.9. Reducing infiltration of outside air through walls from stack effects, and wind loads	TC.9.1. Sealing joints and caulking cracks between window components	TC.9.1.1. Magnetic air sealers and latex caulks	US department of energy
				TC.9.2. Using Rainscreen systems	TC.9.2.1. Pressure-equalized rainscreens (PERs)	(Aksamija, 2013)
				TC.9.3. Using exterior and interior window coverings	TC.9.3.1. Refer to sections: TC.5.3.1, TC.5.3.2., and TC.5.4.1.	
				TC.9.4. Using air flow barriers	TC.9.4.1. Elastomeric emulsion 1 and	(Henry Company, 2012) (Aksamija, 2013)
					TC.9.4.2. Microporous laminate	
Too humid	low humidity	De-humidification	TC.10. Reducing moisture infiltration through façade panels	TC.10.1. Using Semi-permeable vapor barriers	TC.10.1.1. Semi-permeable, Semi-impermeable, or Impermeable vapor barriers	(Aksamija, 2013, p.36)
				TC.10.2. Using water-resistive barriers (WRB)	TC.10.2.1. Adding two layers of felt (WRB) on stone cladding or stucco stud walls	(Glass, Kochkin, Drumheller & Barta, 2015)
				TC.10.3. Using non-absorptive cladding materials	TC.10.3.1. Unbacked vinyl siding and insulated vinyl siding cladding	
				TC.10.4. Using ventilated rainscreens systems. Refer also to section: TC.9.2	TC.10.4.1. Fiber Cement Panels (FCP), Terra cotta, Aluminum Composite Material (ACM)	(Roberts & Guariento, 2009) (facadetechn.com)



			<b>TC.11.</b>	Providing fresh air flows	<b>TC.11.1.</b> Providing dynamic fenestration	<b>TC.11.1.1.</b> Using automated operable windows		
					<b>TC.11.2.</b> Providing passive ventilation by using optimal window sash types	<b>TC.11.2.1.</b> bottom hung windows (opening to inside)	(Richter et al. 2003)/ (Roetzel, Tsangrassoulis, Dietrich, & Busching, 2010).	
						<b>TC.11.2.2.</b> Horizontal pivoted, lower part opening to outside		
						<b>TC.11.2.3.</b> Casement windows or side hung windows (opening to inside)	US department of energy	
					<b>TC.11.3.</b> Providing passive ventilation by optimal distribution of windows	<b>TC.11.3.1.</b> Several bottom hung windows opening to inside	<b>TC.11.3.2.</b> Both sides of bottom and above opening	(Richter et al. 2003)/ (Roetzel, Tsangrassoulis, Dietrich, & Busching, 2010).
						<b>TC.11.4.</b> Night ventilation		(Vassigh & Chandler, 2012)
					<b>TC.11.5.</b> Using open façade systems	<b>TC.11.5.1.</b> Using Louvered panels		
<b>Single-skin glazed façades (curtain wall systems)</b>								
Too hot, Too cold	Low thermal conduction	High thermal resistance of spandrels and glazing units	<b>TC.12.</b>	Reducing conductive & convective heat transfer through mullions and other opaque parts of curtain wall	<b>TC.12.1.</b> Expose only a small part of metal frames to the exterior		(Harvey, 2012, p.85)	
					<b>TC.12.2.</b> Using super insulated panels behind the spandrels	<b>TC.12.2.1.</b> Vacuum-insulated panels (VIPs)	(Capozzoli, Fantucci, Favoino & Perino, 2015)	
						<b>TC.12.3.</b> Increasing opaque part (spandrel areas) with additional insulation on the inside	<b>TC.12.3.1.</b> Using back-coated glass spandrel areas	(Harvey, 2012, p. 86) / (Aksamija, 2013, p.28)
					<b>TC.12.3.2.</b> Using single lite of back-coated glass		(Aksamija, 2013)	
					<b>TC.12.3.3.</b> Applying shadow boxes			
<b>TC.12.4.</b> Using integrated power generating systems	<b>TC.12.4.1.</b> Opaque photovoltaic glass							
					<b>TC.12.5.</b> Applying thermal breaks or using thermally improved materials	<b>TC.12.5.1.</b> Low-conductive separator materials	(Aksamija, 2013) / ( <a href="http://gsap100.wbdg.org/">http://gsap100.wbdg.org/</a> ) / (ASHRAE 2001b, chapter30)	
						<b>TC.12.5.2.</b> Pressure bars		
					<b>TC.12.6.</b> Using insulated spacers and frames	<b>TC.12.6.1.</b> Non-metallic insulated spacers	Van Den Bergh, Hart, Jelle & Gustavsen, 2013.	
					<b>TC.13.</b>	Reducing conductive & convective heat transfer through vision glazing areas	<b>TC.13.1.</b> Using tinted glass	
<b>TC.13.2.</b> Refer to sections TC.3., TC.5., TC.6., TC.7., and TC.8.								

Too air flows	Low air flows from outdoors vice versa	Air and water infiltration control	TC.14.	Reducing air flows and water infiltration through opaque areas	TC.14.1. Using Rainscreen systems: Refer to TC.9.2. and TC.10.4.		(gsap100.wbdg.org) / (Aksamija, 2013) / (HunterDouglas Fassaden, 2014) / (Sanders, Hargrove & AIA LEED AP, 2012) /
					TC.14.2. Adding "back pans" around the perimeter behind opaque areas		
Too humid	Low moisture penetration	High condensation resistance	TC.15.	Reducing air flows and water infiltration through glazing pockets	TC.14.3. Using water-managed systems	TC.14.3.1. Watertighting the frame corners	
					TC.14.4. Providing frame drainage systems	TC.14.4.1. Selecting frames with wept glazing	
					TC.14.5. Providing sealed flashings for curtain wall perimeters	TC.14.5.1. Integrating curtain wall sill flashings with wall flashings of adjacent walls	
					TC.14.6. Maintaining continuity of the air barrier at curtain wall perimeter	TC.14.6.1. Integration of perimeter flashings	
					TC.14.7. Placement of setting blocks with weep holes		
					TC.15.1. Using "pressure plate glazing" (easiest method) for two-sided SSG	TC.15.1.1. Using wet sealants at joints with dry gaskets	
					TC.15.2. Using "structural silicone glazing" (especially in unitized systems with 4-side SSG)	TC.15.1.2. Adding four-sided gaskets	
			TC.16.	Preventing the condensation	TC.16.1. Using thermally broken or thermally improved aluminum frames	TC.16.1.1. Refer to TC.12.5.2., TC. 14.6.1., TC.12.6. and TC.4.1.1.	
						TC.16.2. Adding insulation between curtain wall and adjacent cladding system	

					TC.16.3. Minimizing the proportion of framing exposed to the outdoors		
					TC.16.4. Applying insulation at the curtain wall perimeter		
					TC.16.5. Adding insulation behind the shadow boxes and back-pane sheets	TC.16.5.1. Applying shadow boxes or adding insulation layer between back-panes and exterior cladding	
					TC.16.6. Using ventilated façade systems	TC.16.6.1. Refer to TC.10.4. and TC.11.5. TC.16.6.2. Using louvered spandrels, refer also to TC.11.6	
					TC.17. Providing condensation drainage	TC.17.1. Weeping condensate from spandrel areas to the exterior TC.17.1.1. Using wet-glazed systems (Gunable wet seal over back-up rod or glazing tape) TC.17.1.2. Use condensate gutters and weeps	
Double-skin facades							
Too cold, too hot	Low heat transfer	High thermal resistance of second skin	TC.18	Reducing <i>heat losses</i> through the double-skin facades in winter	TC.18.1. Trapping the heat by keeping the cavity openings closed during the heating		(harvey, 2012, pp.92-93) / (Poirazis, 2006) / (Jager, 2003) / (Vassigh & Chandler, 2012)
			TC.19.	Reducing <i>heat gains</i> through the double-skin facades in summer	TC.19.1. Adding motorized louvres inside the outer façade		
					TC.19.2. Using double-skin façade types with larger gap areas	TC.19.2.1. Corridor and multi-stories types	
Too humid	Low moisture	High thermal resistance of second skin	TC.20.	Preventing the condensation on outer façade	TC.20.1. Closing inner windows when the outside openings are closed in winter		
					TC.20.2. Preventing rainwater entry to the cavity from inlets and outlets	TC.20.2.1. Applying automatic flaps	
					TC.20.3. Using night ventilation		

## Thermal comfort

In developing the façade retrofit action list for thermal performance improvements, ASHRAE's (90.1-2007) three main requirements for mixed climates are taken into account. These requirements are:

- Selecting façade cladding materials with maximum thermal resistance (R-value)
- Selecting window glass panes and frames with minimum heat transfer coefficient (U-value)
- Selecting glazing materials with minimum solar heat gain coefficient (SHGC) and maximum visual transmittance (VT) in summer and maximum SHGC rate and maximum visual transmittance (VT) in winter.

As illustrated in Table 6, thermal discomfort sources are mainly heat losses through evaporation, conduction, and convection, air movement, humidity, and high heat transfers between the indoor and outdoor environment. Thermal comfort is defined as “that condition of mind which expresses satisfaction with the thermal environment” (ASHRAE, 2004). It is achievable if a balance of heat exchange from the environment to occupant and vice-versa is established, which certainly depends on the occupant’s activity level. If the occupant is neutral regarding the indoor air temperature, then it can be said that she/he is thermally comfortable (Reffat and Harkness, 2001). Inquiry into how people perceive their environmental conditions at work is one of the fundamental steps towards the clarification of comfort moderators. Several research works have been carried out on the workers’ interaction with their work environment. As reviewed in section 3.3, comfort perception of occupants realized in three domains: behavioral adjustment, physiological adaptation, and psychological expectation. Several methods are used by researchers for thermal comfort assessments. Methods like, Predicted Mean Vote (PMV) and Predicted Percentage of Dissatisfied people (PPD) are instances, which are used by designers in all around the world. In non-air-conditioned buildings, PMV method is used by means of an expectancy factor (Al horr et al., 2016). Steady-state comfort models like, PMV define the heat balance of the human body by six parameters: four environmental and two behavioral. The environmental parameters are :

- Air temperature
- Radiant temperature (surrounding surface temperatures)

- Humidity
- Air speed

The two personal comfort parameters are:

- Clothing insulation
- Metabolic heat (activity rate)

Referring to the psychological dimension of adaptation, (Candido, 2013, p.182) claims that occupants' expectations and thermal sensation in their interactions with the environment (i.e. personal thermal control), or diverse thermal experiences will be changed. Based on this concept, two important items must be considered when designing passive retrofit projects:

1. Natural ventilation enhancement
2. Occupant control

The energy consumption of a typical office building throughout a day differs with occupancy (McGuire et al., 2009). Efficiency improvement can be realized if retrofit interventions are framed in accordance with occupancy behavior. In other words, considering occupants' role in controlling indoor environment should be a significant criterion in adjusting retrofitting strategies (Rajapaksha, Hyde, and Groenhout, 2013, p.81). Therefore, in provision of adaptive opportunities, the concept of active occupants must be a major criterion in the building design for comfort achievements (Candido, 2013, p.179).

### **Thermal comfort: comfort indicators and performance criteria**

The flow of heat through façade follows a number of certain processes (Harvey, 2012; Aksamija, 2013):

- *Conduction* (heat flows between two contacted façade surfaces) of heat through the wall panels, through the glass, through the air between the panes, and through the frame and spacers between the panes
- *Convection* (conveyed heat by air) between the panes of glass
- *Transmission* of solar (short wave) radiation
- *Emission* of infrared (IR) radiation (Radiation is a major criterion that affects thermal comfort (Reffat and Harkness, 2001).
- *Infiltration* of outside air through glazing or opaque areas of the façade

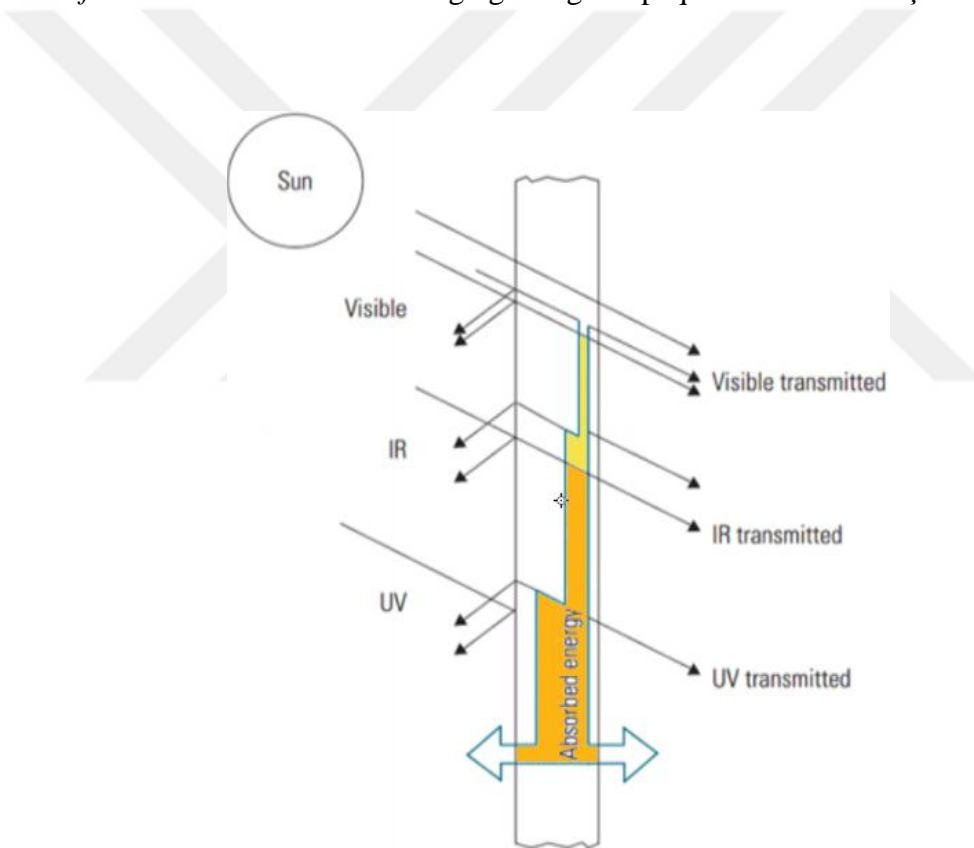

**Figure 4.22.** Light and heat transmission through glass (by the author).

Thermal comfort indicators that affect the heat flow through the façade in literature are remarked as thermal resistance factor (R-value), heat transfer coefficient factor (U-

value), solar heat gain coefficient (SHGC), air leakage control, and water permeance factor (in perm).

- *Heat transfer coefficient (U-value):*
  - i. The colder the climate, and/or the more expensive the heating fuel, the more important a lower U-value
- *Solar Heat Gain Coefficient (SHGC):*
  - i. The lower the solar heat gain coefficient, the better the glazing material will be at blocking radiative heat gains through the windows
  - ii. For cooling dominated mixed climates, the solar heat gain coefficient factor of glazing becomes more important and the lower the SHGC the better the window performance.
  - iii. For heating dominated mixed climates the higher the SHGC the better the window performance.
- *Visible transmittance:*
  - i. The ratio of visible transmittance to solar heat gain. A high ratio will increase lighting savings.

Performance criteria section comprises retrofit recommendations for controlling heat flow based on the process type of heat flow described above. Performance section, mainly, includes alternative actions, such as the use of thermally insulated materials or glazing, using continuous thermal barrier, using smart materials (i.e. PCMs), filling air gaps between materials or using gas-filled glass panes like Argon in multi-layer windows, providing a continuous air barrier to reduce heat loss, and preventing thermal bridging.

**Table 4.7.** Façade retrofit framework for improving visual comfort (by the author)

Problem	Main Goal	Visual Comfort Indicator	Visual comfort No.	Visual Performance Criteria	Performance	Option No.	Source	
Single-skin clad and curtain wall facade systems								
Limited access to daylight	optimal daylight gains	Expanding daylighting zone	VC.1.	Increasing daylight gains by redirecting <u>diffuse</u> sunlight into the interior	VC.1.1. Providing top-lightings	VC.1.1.1. Vertical double clerestories	(Hastings, 1994, chapter 21) / (elad.su-per-b.org) / (lightshowwest.com) / (waskoskylights.com)	
						VC.1.1.2. Sawtooth clerestories		
						VC.1.1.3. Skylights		
						VC.1.1.4. Vertical reflective baffles		
						VC.1.1.5. Translucent aerogel skylights		
						VC.1.1.6. Domed skylights		
						VC.1.1.7. Anidolic zenithal openings		
			VC.1.2. Providing side-lightings	VC.1.2.1. Anidolic ceilings	(IEA, 2000a) / (Harvey, 2012) / (Baker and Steemers, 2002) /			
				VC.1.2.2. Zenithal light-directing glass				
			VC.2.	Increasing daylight gains by <u>reflecting direct beam sunlight</u> into the interior	VC.2.1. Providing top-lighting	VC.2.1.1. Horizontal skylights with holographic optical elements (HOEs)	(IEA, 2000a)	
						VC.2.2. Providing side-lighting	VC.2.2.1. Light shelves	(Hastings, 1994, chapter 21) / (IEA, 2000a) / (Harvey, 2012) / (Oakley, G., Riffat, S. and Shao, L. 2000) / (AlMarwae, M. and Carter, D. J. 2006) / (Edmonds and Greenup, 2000) / (Aksamija, 2013)
							VC.2.2.2. Light-directing	
							VC.2.2.3. Automatic venetian blinds	
							VC.2.2.4. Passive light	
							VC.2.2.5. Active light pipes	
VC.2.2.6. Prismatic panels								
VC.2.2.7. Laser-cut panels								
VC.2.2.8. Light-guiding shades								
VC.2.2.9. Anidolic solar blinds (louvers)								
VC.3.	Increasing daylight by <u>dual functionality</u> : redirecting diffuse sunlight and reflecting direct sunlight	VC.3.1. For both top-lighting and side-lighting options	VC.3.1.1. Holographic transparent shading	(IEA, 2000a) / (Harvey, 2012)				
			VC.3.1.2. Sun-directing glass					



Too glare + weak distribution of daylight	Low direct light gains	Providing glare-free daylight	VC.4.	Improving distribution of daylight while reducing glare	VC.4.1. Adjusting ceiling properties regarding the existing vision area	VC.4.1.1. Slopped down ceilings for rooms with smaller vision areas VC.4.1.2. Slopped up ceilings for rooms with larger vision areas	(Aksamija, 2013, p.60)
			VC.5.	Reducing glare in spaces with skylights (maximum daylight but minimum glare)	VC.5.1. Optimizing the cut-off angle of skylights according to the space properties	VC.5.1.1. Avoid skylights in spaces with low ceiling height VC.5.1.2. Providing cut-off angle of 55 for office spaces working with computers VC.5.1.3. Providing both straight and splayed walls around skylight	(Skylighting Design Guidelines, 2014)
					VC.5.2. Integrating horizontal skylights with louvered sun control devices or HOEs		
					VC.5.3. Integrating north-facing clerestories with sun-catchers		
Summer overheating	Low direct light gains and low SHGC	Preventing heat gains while providing daylight	VC.6.	Reducing glare in spaces with side-lighting systems	VC.6.1. Selecting proper side-lighting among the sections: vc.2.2.1., vc.2.2.2., vc.2.2.8., vc.2.2.9., VC.6.2. Combining translucent glass with transparent vision glass		(Aksamija, 2013, p.58) /
					VC.6.3. Using daylighting systems with shading ability	VC.6.3.1. Directional selective shading system with HOEs VC.6.3.2. Automative venetian blinds VC.6.3.3. Anidolic zenithal openings VC.6.3.4. Light-guiding shades VC.6.3.5. Light-directing louvers VC.6.3.6. Anidolic solar blinds	
			VC.7.	Providing daylight while reducing glare and SHGC value of glazing units	VC.7.1. Using glazing systems with high visible transmittance and low NIR transmittance	VC.7.1.1. Using switchable low-e glass coatings VC.7.1.2. Using high-iron glass VC.7.1.3. Using Electrochromic glasses VC.7.1.4. Using Spectrally selective double-lite air-insulated low-e glazing	(Malekafzali Ardakan, Sok & Niemasz, 2017)
					VC.7.2. Using dynamic glazing or dimming systems	VC.7.2.1. Thermochromic or Photochromic dynamic glazing VC.7.2.2. An occupancy-based control switchable windows with low-e coating in combination with an electrochromic layer	(Raicu et al., 2002) / (Harvey, 2012, p.84) / (Inoue, 2003) / (Xing, Hewitt, & Griffiths, 2011) / (Jonsson, & Roos, 2010) / (Yik, & Bojić, 2006) / (Jonsson, & Roos, 2010) /
					VC.7.3. Synchronizing the solar transmissivity with sunlight angle	VC.7.3.1. Using angular-selective thin films	

No access to outside view	view to out	High VT	VC.8.	Providing outside view while reducing glare	VC.7.4. Using low-emissivity coatings on glazing	VC.7.4.1. Using reflective-transparent silver mirror-like films (east and west facing façades)	(Lee, Selkowitz, Bazjanac, Inkarajrit & Kohler, 2002)				
						VC.7.4.2. Using ceramic fritted or tinted glazing					
						VC.7.4.3. Using Spectrally selective low-e coatings					
								VC.7.5. Using proper external shading devices	VC.7.5.1. horizontal and adjustable shading devices on south façade	(Lee, Selkowitz, Bazjanac, Inkarajrit & Kohler, 2002)	
									VC.7.5.2. vertical and adjustable shading devices on west, east, and north facing façades		
									VC.7.5.3. Using fritted glass louvers		
									VC.7.6. Using light colored and open weave fabric interior shading devices	VC.7.6.1. Venetian blinds (durable & economic)	
										VC.7.6.2. Adjustable Cellular shades	
									VC.8.1. Selecting daylighting systems with adjustable shading ability to provide outside view	VC.8.1.1. Light shelves, Anadolic ceilings, Laser-cut panels	
									VC.8.2. Using dynamic glazing	VC.8.2.1. Electrochromic glass	(Malekafzali Ardakan, Sok & Niemasz, 2017)
				VC.8.3. Using perforated blind systems		(Lee, Selkowitz, Bazjanac, Inkarajrit & Kohler, 2002)					
Double-skin facades											
			VC.9.	Providing daylight while reducing glare and SHGC value of glazing units	VC.9.1. Adding motorized louvres inside the outer façade		(harvey, 2012, p.92) / (Hendriksen et al.) / (Vassigh & Chandler, 2012)				

## Daylighting and visual comfort: comfort indicators and performance criteria

Visual comfort can be perceived by a person, who has the right level of light either natural or artificial to perform her/his work. Visual comfort criteria can be listed as, illuminance (1 fc = 10.764 lux), daylight distribution, glare amount, exposure to direct sunlight, views to outside, and visual privacy. The daylight triggers from the large scale to small can be remarked as, climate (daylight availability), site and location (orientation and external obstructions), building's fenestration material and properties, shading systems, and control systems by occupants in the room.

The electrical energy consumptions are one of the major energy consumptions in office buildings due to the cooling and lighting demands of these types of existing buildings. To reduce the reliance of the workers on using artificial lighting sources, efficient and adequate provision of the natural light is essential in office buildings. As regards the fact that even high-performance light fixtures generate considerable warmth in the space, achieving daylight will eliminate cooling loads of the building. Consequently, visual comfort retrofits can be grouped in two main objectives: 1) energy conservation and 2) daylight provision as much as possible. However, different regions and climates require different retrofit actions regarding admitting daylight to the interior space of the building. In mixed climates, as the focus point of this study, combined retrofit actions must be implemented in order to harmonize the daylight needs, and sometimes protect from sunlight. In other words, daylight strategies can be summarized in using natural light by increasing glazed areas of south and north-facing façades with appropriate shading components (Aksamija, 2013, p.14). As mentioned before, visual comfort indicators that affect the access to the daylight through the façade in literature are remarked as:

- Visual transmittance (VT),
- Window-to-wall ratio (WWR),
- Solar heat gain coefficient (SHGC),
- Light to solar gain ratio (the ratio of visible transmittance to solar heat gain. A high ratio will increase lighting savings while reducing cooling losses)
- Diffusing Properties of Glazing

Performance criteria section comprises retrofit actions that control daylight gains based on the certain demands in every office buildings for mixed climates. Mainly includes increasing daylight amount by using direct or diffuse sunlight and reducing glare in interior spaces. Daylighting systems with a combination of simple glazing with other components are used in building facades to improve the daylight control and delivery. These systems can be applied based on two different demands; the need for a direct

sunlight (by either reflecting or refracting direct radiation) or a diffused form (by redirecting diffuse radiation). In other words, these actions might be used to reflect direct sunlight rays with or without shading the window or to redirect diffuse sunlight into the inside of the building, with or without shadings (Harvey, 2012, p.390).

### **Acoustic comfort: comfort indicators and performance criteria**

A space with a good acoustic quality attenuates undesired noises while accepting desired sounds. The interior spaces of office buildings typically need a domain of ambient sounds to cover their speech and achieve speech privacy in their work stations. For this purpose, providing “white background” should be undertaken in retrofit actions to improve acoustic quality of the space (Duffy, Cave & Worthington, 1976, pp.133-139; Reffat & Harkness, 2011). The acoustic discomfort due to the interior triggers is beyond the scope of this study and needs evaluation methods in the field of acoustic. In this very regard, this study focuses only on external triggers of acoustic quality, which can be limited by means of the related retrofit actions to improve the façade system of the building. The most important acoustical factors are as follows:

- Background (ambient) noise level (db): amount of noise generally distributed within interior space
- Noise criteria (NC levels): relative loudness of a space
- Outdoor-indoor transmission class (OITC): a rating for assessing the ability of exterior enclosure assemblies to hamper source sound
- Noise reduction coefficient (NRC): a rating for assessing the sound-absorption ability of materials

**Table 4.8.** Façade retrofit framework for improving audial comfort (by the author).

Problem	Main goal	Acoustic comfort indicator	Acoustic comfort No.	Acoustic performance criteria	Performance	Option No.	Source	
<b>Single skin clad façades (discontinuous windows)</b>								
Too much external noise	Increasing acoustical efficiency	High outdoor-indoor transmission class (OITC) for opaque façade	AC.1.	Increasing sound insulation through the opaque parts of the façade	AC.1.1. Increasing the mass of the materials		(Aksamija, 2013) / (harvey, 2012, p.82)	
					AC.1.2. Using different layers of cladding materials			
					AC.1.3. Providing acoustic breaks			
					AC.1.4. Providing air spaces between adjacent walls	AC.1.4.1. Increase the width of air spaces in opaque walls		(Shekar & Krarti, 2017) / (Paris-Newton, Prokofieva & Henry, 2015)
					AC.1.5. Using acoustic insulations	AC.1.5.1. Silica aerogels, closed cell foam, cellulose, and etc. AC.1.5.2. Adding insulation within air spaces		
					AC.1.6. Sealing air leaks in the wall assembly			(Tata Steel, 2012)
AC.2.	Increasing sound absorption through cladding panels	AC.2.1. Using non-reflective materials, like liner sheets						
AC.3.	Reducing noise impacts of rain on cladding panels	AC.3.1. Adding flexible insulation layer below the external skin	AC.3.1.1. Using insulated façade systems, sandwich construction, and thermal breaks					
<b>Single-skin curtain wall systems</b>								
Too much external noise	Increasing acoustical efficiency	High outdoor-indoor transmission class (OITC) for glazed façade	AC.4.	Reducing sound transmission through the glazing area	AC.4.1. Increasing the thickness of glass	AC.4.1.1. Incorporating different thicknesses of glass in an insulated glass unit	(http://gsap100.wbdg.org) / (Aksamija, 2013, p.65) / (Libby, 2001)	
					AC.4.2. Incorporating noise-reducing interlayer	AC.4.2.1. Using PVB laminated glass		
					AC.4.3. Using standard air-filled insulating glass			
					AC.4.4. Laminated + insulated glazing	AC.4.4.1. One lite or two lites of 1/4 inch laminated glass		
					AC.4.5. Using triple-glazed insulating units	AC.4.5.1. Using insulated unit, constructed with a "soft" separation between the lites of glass AC.4.5.2. Using an assembly consisting of: a standard 1-inch insulating unit, a 2-inch air space, and an inner lite of 1/4-inch glass will have an OITC of 32-35 and an STC of 42-44.		
					AC.4.6. Using acoustic breaks	AC.4.6.1. Using "pressure bars"	(http://gsap100.wbdg.org)	
<b>Double-skin facade systems</b>								
			AC.5.	Reducing external sound transmissions	AC.5.1. Adding a secondary façade skin to the original façade	AC.5.1.1. Box windows type AC.5.1.2. Multi-stories façades	(Harvey, 2012, p.92) / (Alibaba and Ozdeniz, 2011) / (Poirazis, 2006)	

Among the mentioned criteria, OITC and NRC ratings are most related factors for the scope of this study in representing façade retrofit recommendations. According to ASHRAE (2009), a high-performance façade should have an OITC of at least 40 and the fenestration part should have at least 30. For OITC, the higher the number, the product will act better in terms of acoustic efficiency. The acoustic performance criteria in the literature are indicated in respect of three major actions required for:

- Increasing sound insulation
- Increasing sound absorption
- Noise reduction

The details of related actions and the possible technological options are represented in the Appendices Section at the end of the thesis.

### **A Quick Overview**

In the Chapters 4.1, 4.2, and 4.3, main parts of the final framework have been conducted and discussed in details. In the Chapter 4.1 the potential opportunities in the existing and pre-defined condition of the building have been discussed. Although, in a retrofit project many of these pre-defined conditions such as, building orientation, form, and plan depth cannot be adjusted or changed, however, the effectiveness of implementing passive actions is in a tie correlation with building's context, its climatic issues, orientation, and etc. Chapter 4.2 discussed the hierarchy and the essential steps through the generating of the framework, which is comprised of viable alternatives for distinct problems that can be used by decision maker in the initial steps of the retrofit process to achieve a general knowledge about different alternatives for each problem. The actions were considering spatial arrangements of offices in terms of internal and peripheral zones. The Chapter 4.3 represented façade retrofit framework in terms of three comfort domains; thermal, visual, and acoustic comfort. The actions are investigated for three types of non-load bearing façade systems; 1) single-skin cladded

façades, 2) single-skin glazed façades (curtain walls), and 3) double-glazed façade systems.

The passive interventions in developing the façade retrofit framework for this thesis presented upon seven strategies, 1) reducing heat loss in winter, 2) reducing overheating in summer, 3) providing natural ventilation, 4) increasing daylight opportunities, 5) reducing glare effects, 6) reducing stuffiness, and 7) reducing external and internal noise. Passive retrofit strategies can have deep impact on thermal loads of single-skin non-bearable façades with measures such as shading, fabric insulation, optimizing glazing ratio, and many other performances and measures, which are elaborated in Tables 4.4 , 4.5 , and Tables 4.6, 4.7, and 4.8, representing respectively, *Spatial Comfort Framework* and *Façade Retrofit Framework*. Table 4.9, provides a brief summary of the presented passive retrofit actions in these frameworks by addressing the five main requirements of heating, cooling, ventilation, daylight, and acoustic measures.

**Table 4.9.** Presented passive retrofit actions (by the author).

Requirement	Passive Retrofit Actions															
Heating	TC.1.	TC.2.	TC.3.	TC.4.	TC.5.	TC.9.	TC.12.	TC.13.	TC.14.	TC.15.	TC.18.	SC.1.	SC.2.	SC.11.		
Cooling	TC.1.	TC.2.	TC.3.	TC.4.	TC.6.	TC.7.	TC.8.	TC.11.	TC.19.	TC.20.	VC.7.	VC.9.	SC.3.	SC.4.	SC.9.	SC.10.
Ventilation	TC.10.	TC.11.	TC.16.	TC.17.	TC.20	VC.9.	SC.4.	SC.10.								
Daylight	VC.1.	VC.2.	VC.3.	VC.4.	VC.5.	VC.6.	VC.7.	VC.8.	VC.9.	SC.7.	SC.12.	SC.14.	SC.15.			
Acoustic	AC.1.	AC.2.	AC.3.	AC.4.	AC.5.	SC.8.	SC.13.									

Along with spatial comfort framework, more than 150 passive retrofit actions have been conducted that can be implemented through the energy retrofit projects with the aim of improving both façade performance and indoor comfort in office spaces.

**Table 4.10.** The total number of presented actions for each comfort domain.

Comfort domain	Discomfort problems No.	Performance criteria No.	Performances (actions) No.	Options No.
Thermal Comfort (TC)	4	20	70	93
Visual Comfort (VC)	2	9	22	49
Audial Comfort (AC)	1	5	15	12
Spatial Comfort (SC)	7	17	52	None
Total	7	51	159	154

### Relation Matrix

As mentioned in previous chapters, the main challenge throughout the decision-making process is providing the best tradeoff among the proposed viable alternatives since, they do not perform in harmony with each other. Some actions are in conflict with each other or some of them have an identical impact or might be complement each other. For this purpose, the proposed alternative actions need to be categorized in a relationship matrix to realize, whether they have the same effects, supplemental effects, or contradictory effects. Table 4.11 illustrates the relationship among these actions.

**Table 4.11.** Relationship Matrix: identifying the interaction of retrofit actions (by the author).

Relations	Actions																			
Conflicted Actions	TC.1	TC.2	TC.4	AC.5		TC.3		TC.5	TC.13	TC.6										
Supplemental Actions	SC.10	TC.11	TC.11	TC.8	SC.3	SC.10	TC.16	TC.6	TC.7	VC.8										
Identical Actions	TC.3	TC.3	TC.3	TC.7	TC.9	TC.11	TC.19	VC.2												
	TC.7	TC.13	TC.12	VC.7	TC.10	TC.16	VC.9	VC.8												



### Alternative actions for conflicted performances

The most challenging performances are presented in the previous Table 4.11. This section by referring to the framework, provides the alternative actions for the contradictory performances.

For instance, in the case of TC.6 and TC.13, the main goal is reducing solar heat gains through fenestration and preventing the summer overheating problem by means of tinted glass units or fixed shading devices, which will minimize the view to outside. Consequently, actions TC.6 and TC.13 will be in conflict with the VC.8 action, which is increasing visible transmittance. The alternative action can be referred to the action TC.7 from the framework. Table 4.12 illustrates some of the significant conflicted actions and possible alternatives for them, all from the developed framework in this thesis.

**Table 4.12.** Conflicted actions and the alternative performances within the retrofit framework

Performance Criteria	Conflicted Performance Criteria	Alternative Actions
TC.6 and TC.13	VC.8	TC.7
Low solar heat gains through vision glass units in summer (Low SHGC)	High visible transmittance (High VT)	Using switchable low-e coating
		Using high-iron glass types
		Using angular-selective films
		Using Electrochromic windows
		Using low emissivity coatings
		Using proper external shadings

Performance Criteria	Conflicted Performance Criteria	Alternative Actions
TC.1, TC.2, TC.4	SC.10 and TC.11	
High thermally insulated materials (high R-value)	Providing cool air flows (natural ventilation)	Using dynamic insulation
TC.3	TC.8	
Low heat losses and cold draught effects (winter)	High solar heat gains in winter (High SHGC)	Using low-iron glass types
		Vacuum insulated windows
		Adding low-e coating on surface #3 in a double-glazed window
		Motorized shading devices and roof overhangs for summer time
TC.5	TC.6 and TC.7	
High solar heat gains in winter (high SHGC)	Low solar heat gains in summer (low SHGC)	Using low-e coated flappable windows
		Using spectrally selective low-e coatings
		Motorized shading devices and roof overhangs for summer time
TC.5	VC.5	
Low heat losses and cold draught effects in winter	High visible transmittance (High WWR and VT)	Using gas-filled multi-pane glazing system
		vacuum-insulated windows
		Sealing joints and caulking cracks between window components

## CHAPTER 5

### GENERAL GUIDELINES TO USE THE PROPOSED FRAMEWORK

Every retrofit project is different, not only in terms of the existing building's pre-defined condition and the required retrofit actions, which best suited to the user needs, but also regarding the project specifications. However, each retrofit project passes a hierarchical process including pre-retrofit, retrofit, and post-retrofit phases. Based on the reviewed literature in the section 2.7.1, a retrofit roadmap have been drawn as seen in Figure 5.1.

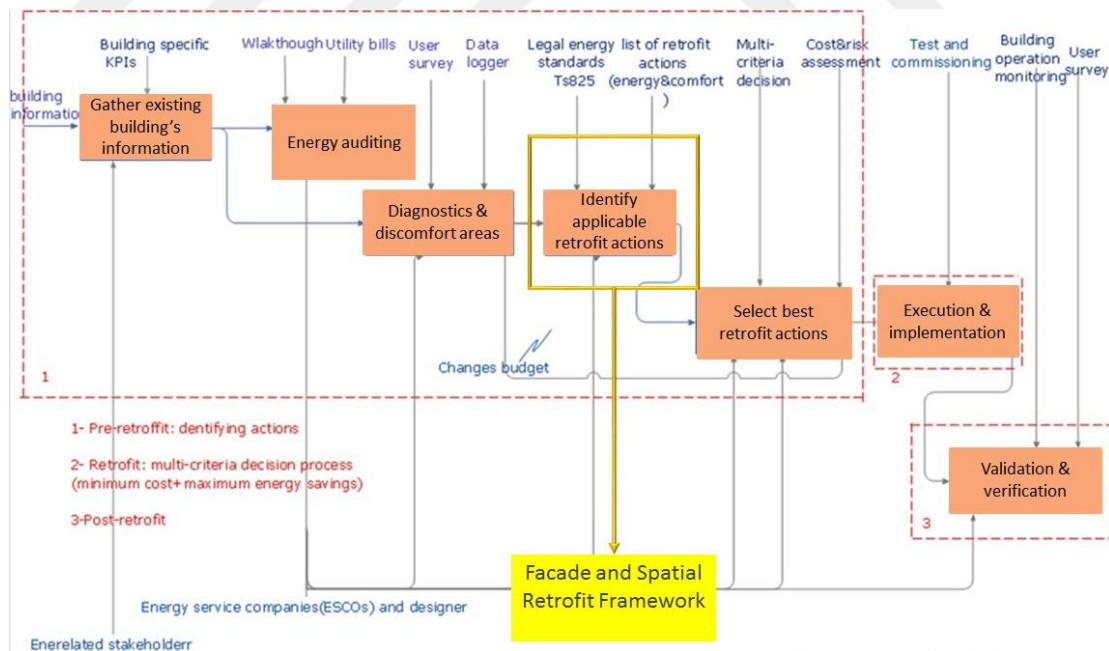

**Figure 5.1.** IDEF0 diagram of a systematic retrofit roadmap (by the author, based on literature).

Regarding the roadmap, in the first three sub-phases, decision maker attempts in collecting the pre-defined characteristics of the existing building, its energy performance, and identifying the main problematic areas in terms of components and discomfort sources, by means of energy auditing methods, user survey, and data loggers. Fourth sub-phase of the pre-retrofit phase, requires a list of applicable retrofit actions, addressing the user comfort requirements based on the surveyed data. The conducted Retrofit Framework in this thesis can be used in this phase of the roadmap.

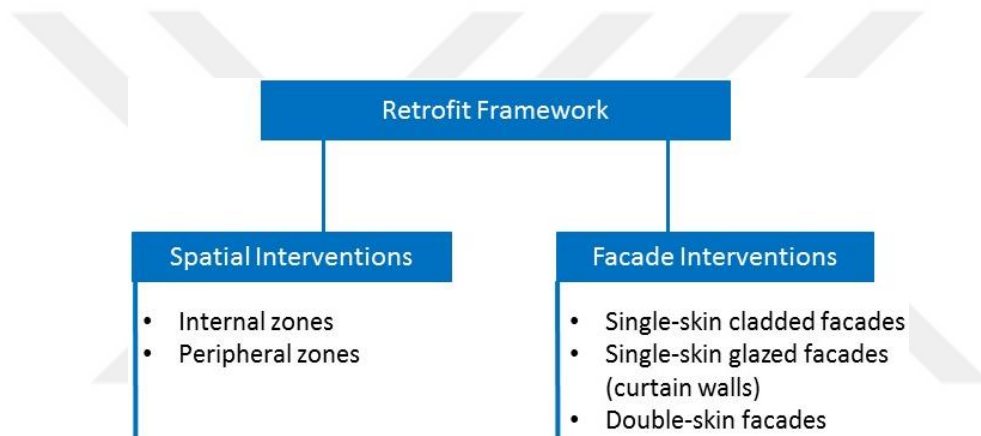

**Figure 5.2.** The general structure of proposed retrofit actions in the Retrofit Framework.

As discussed at the end of Chapter 3, in order to establish the required comfort quality, the retrofit interventions are classified in this thesis in two categories: 1) *Spatial Retrofit (SR)* and 2) *Facade Retrofit (FR)*. Spatial interventions represent applicable retrofit actions on the interior parts and are divided into internal and peripheral zones, which were elaborated in Section 4.2. Façade interventions form the basis of the façade retrofit framework, which was represented in Section 4.3. Figure 5.3 gives a detailed information regarding the supported phases of the retrofit process by the developed energy retrofit framework in this thesis.

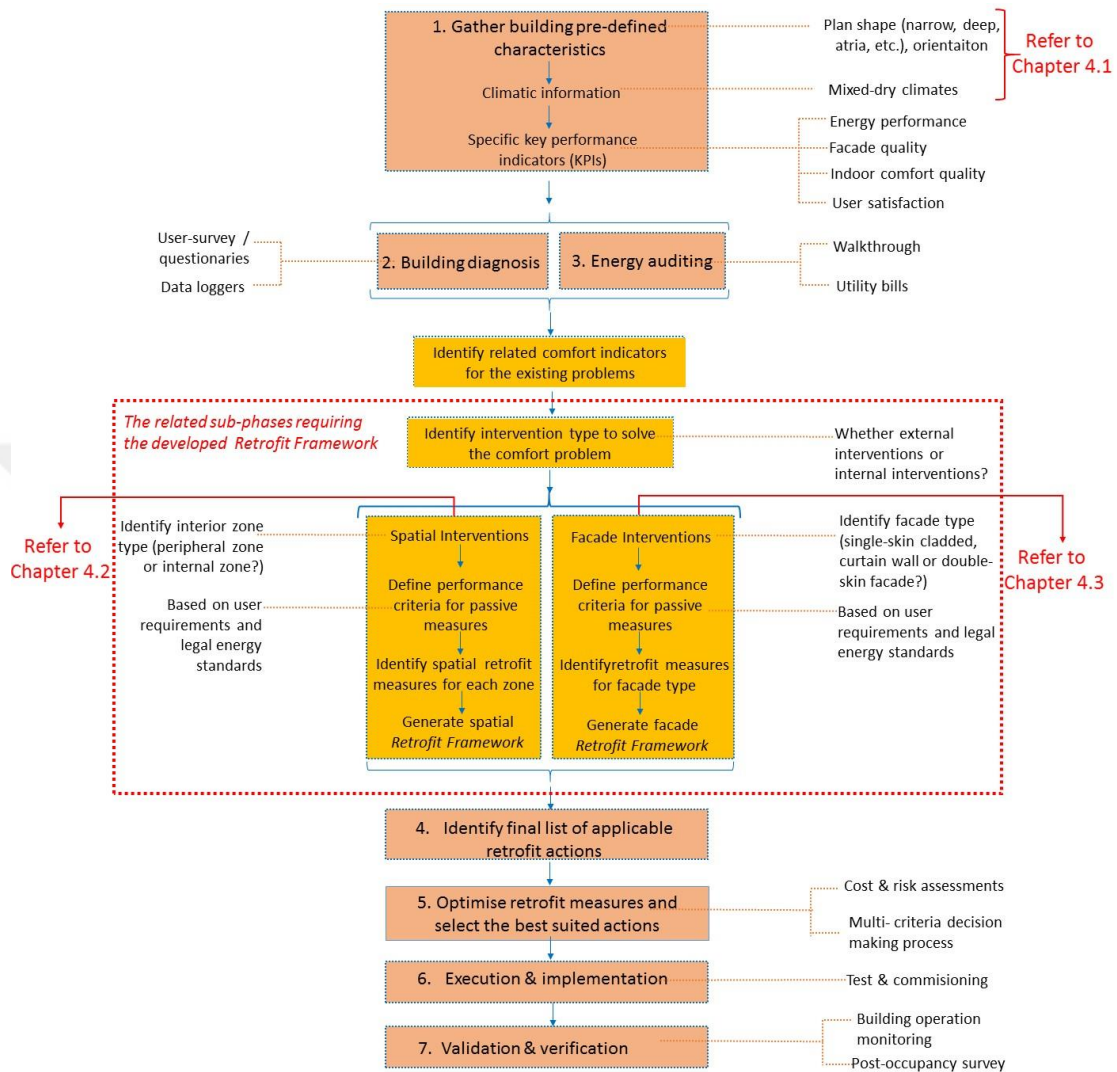

**Figure 5.3.** IDEF0 diagram of a systematic retrofit roadmap (based on literature).

After developing the “framework” as an approach to support the initial decisions through the retrofit projects, this section sets off a detailed guidelines through the flow charts considering how this framework can be used by building owners, designers, and the other retrofit stakeholders. Based on the theoretical, several passive retrofitting actions were systematically organized into the framework. The actions were provided into two contexts of façade interventions (façade retrofit) and spatial interventions

(spatial retrofit) and were categorized in response to seven comfort problems named, P1) too cold winters and too hot summers P2) too cold winters, P3) too hot summers, P4) too stuffy, P5) low daylight, P6) too glary, and P7) too noisy. In this way the searching of required action for the existing problem becomes easier in the early stage decision makings. P1, P2, P3, and P4 are attributed to the thermal comfort domain, P5 and P6 to visual comfort domain, and finally, P7 to the acoustic comfort domain. For thermal problems in buildings with façade types of single-skin cladded, single-skin glazed, and double-skin systems, 24 performance criteria both in façade and spatial retrofit framework are recognized. Decision maker by following the Chart 5.4 and regarding the problem can identify the required actions.

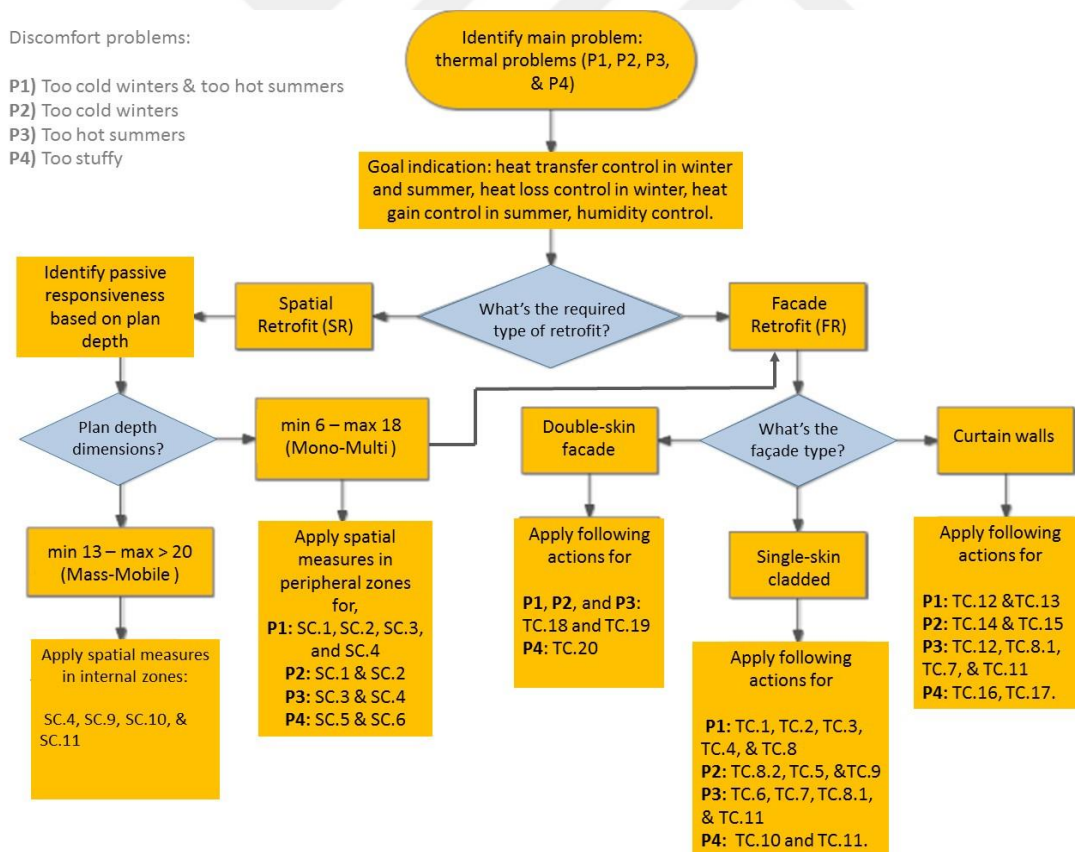

**Figure 5.4.** Flowchart diagram for establishing thermal comfort (by the author).

Similar to the thermal problems, for visual discomfort problems in buildings with façade types of single-skin cladded, single-skin glazed, and double-skin systems, 12 performance criteria both in façade and spatial retrofit framework are recognized. Decision maker by following the Chart 5.5 and regarding the problem can identify the required actions.

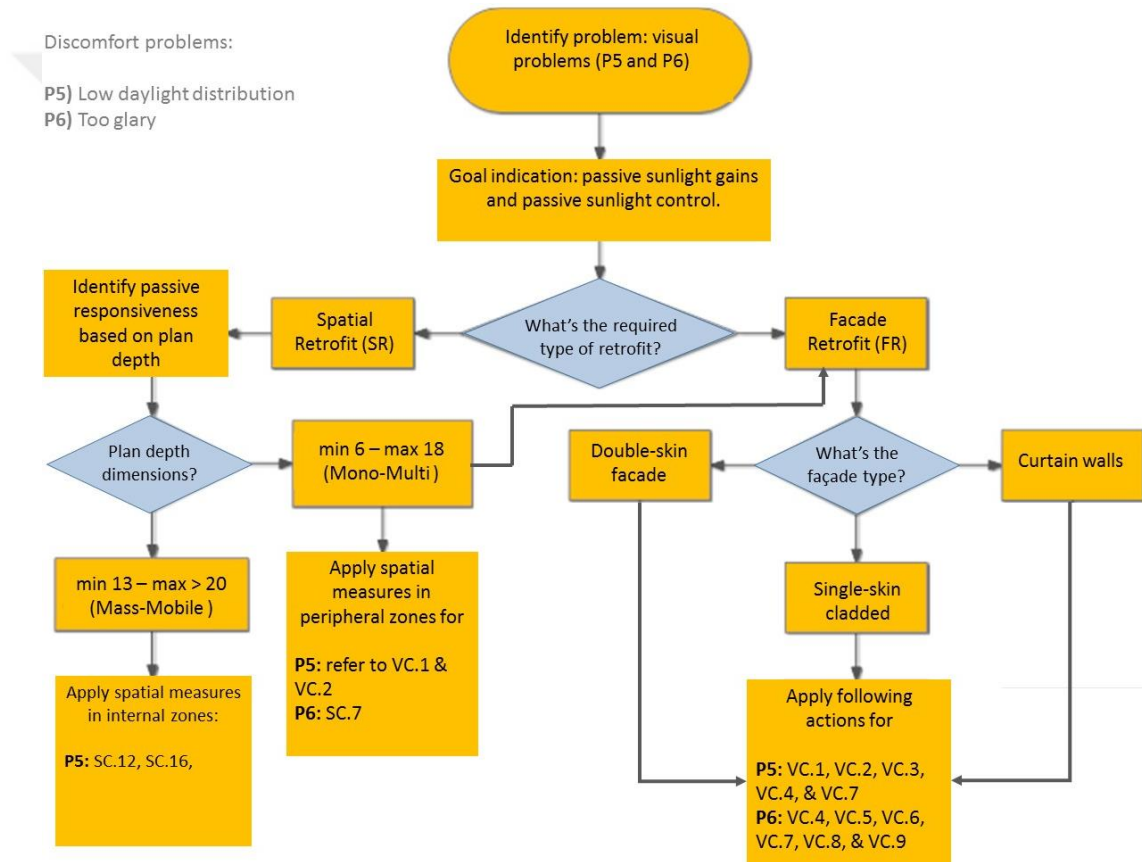

**Figure 5.5.** Flowchart diagram for establishing visual comfort (by the author).

Finally, for acoustic discomfort problems in buildings with façade types of single-skin cladded, single-skin glazed, and double-skin systems, seven performance criteria both in façade and spatial retrofit framework are recognized. Decision maker by following the Chart 5.6 and regarding the problem can identify the required actions.

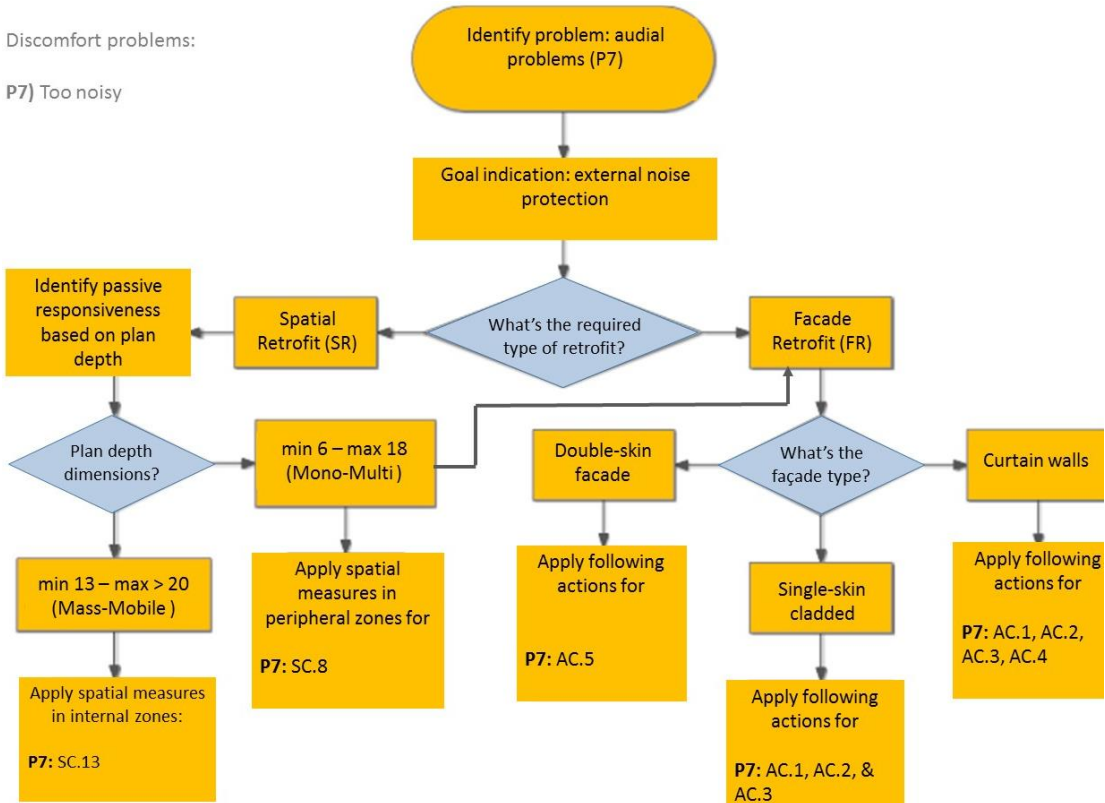

**Figure 5.6.** Flowchart diagram for establishing audial comfort (by the author).



## CHAPTER 6

### DISCUSSION AND CONCLUSION

This chapter presents the thesis conclusions. Firstly the research question and sub-questions are revisited and discussed. The research questions outline the thesis structure. Therefore the conclusions summarize the main findings of each question. The first two chapters, after the Introduction Chapter, comprised the theoretical background that shape the research question, discussion of the commercial building stock, energy performance and retrofit practice. Chapters 4 presents the core of the approach, which is the generation of *Spatial Retrofit Framework* and *Façade Retrofit Framework*. Chapters 5, represents a general guidelines regarding how the framework can be used as a decision support manual by stakeholders. Finally, Chapter 6 the as the last chapter, consists of a discussion along with the recommendations for future applicability of the approach and research to further develop it.

A deeper analysis of the recent literature on the energy retrofit processes revealed that most of these studies and research works do not address any information on the selection of indicators or the performance criteria of the considered retrofit actions. Additionally, majority of the conducted façade retrofit studies do not involve the fact that to what extent the indoor environment of the considered building responses effectively to the applied retrofit actions on its façade system. Providing a comprehensive integration between two key domains of energy efficiency and comfort, mainly, fails through the façade retrofit practices and studies.

The developed retrofit framework supports the initial decision making process by organizing energy and comfort retrofit measures, therefore, they can be comparable. The previous chapters explained the different measures for both domains of energy efficiency and indoor comfort improvements in frame of the *Façade Retrofit Framework* and the *Spatial Comfort Framework*. In this thesis, the targeted energy retrofit measures are those that improve both energy efficiency and indoor comfort quality. Accordingly, this thesis put its hypothesis on the firm interdependent relationship among three scales of building, its façade, and its indoor environment and began with the belief that the conduction of a holistic façade retrofit framework needs to consider all these scales and their relations. For this purpose, the three-step process is taken into account for the generating façade retrofit framework; 1) *building* scale: identifying pre-defined characteristics of the existing building for improving energy performance, 2) *façade* scale: organizing effective passive retrofitting actions on existing façade, and 3) *room* scale: developing a spatial comfort framework for five different office layouts called, *Mono*, *Multi*, *Mass-Rigid*, *Mass-Flex*, and *Mobile*.

### **Research Question**

*How can the passive energy improvement actions be integrated with different indoor environments through the façade retrofitting of existing office buildings, in order to support decision-making?*

The answer to the research question is given by the proposed retrofit framework. It consists passive retrofit measures proposed at a three-step process that can support the decision-making of office buildings' façade retrofit actions. The mentioned three-step process is considered in a hierarchy structure including building's predefined opportunities, spatial comfort framework, and façade retrofit framework. For the first step of the process, the pre-defined characteristics of the existing buildings, which are the target of a retrofit process in mixed-dry climates are investigated. Identifying and understanding the existing building is essential for the development of any retrofit process. The characteristics of the existing building that need to be identified are related

to the building climatic conditions, the building type, plan shape and form of the building, the orientation of the façades that are considered for retrofitting and the window wall ratio. The argued details in this regard are provided in the Chapter 4.1.

In this thesis three fundamental comfort domains, which are affected by building façade performance are considered: thermal comfort, daylight, and acoustic comfort. The comfort subject is defined in a hierarchical structure comprised of six levels of “discomfort problem”, “main goal”, “comfort domains”, “comfort criteria”, “performance criteria”, and “performance options”. The problem is placed at the top level, followed by the specific goal in the frame of one of the three domains of comfort, which are contributed to the related comfort indicators, each indicator is extended to a number of performance criteria that are finally specified by one or more recommended performance options. This kind of formalization helps the user to reach a set of viable performance recommendations as solutions to the existing problems. The argued details in this regard are provided in the Table 4.3.

Reviewed literature revealed that establishing high comfort quality entails a substantial amount of energy consumption. Particularly, the conflict between high comfort quality and high energy demands becomes more prominent in office buildings. Accordingly, a firm tie between energy performance of the building and its indoor comfort should be established through the retrofitting process. To answer the question of how the internal zones can benefit from the opportunities of the façade retrofit actions, the internal zones clarified in terms of type, depth, and work pattern. As argued previously, different office organization, regarding its work style and requirements, have different interior spatial arrangements. Several typologies on defining spatial arrangements are represented by several researchers. However, this thesis put its focus on Duffy’s office framework, which is substantially, more comprehensive than the rest. In this regard, five different types of office spatial arrangements have been identified. These types named as, Mono, Multi, Mass-rigid, Mass-flex, and Mobile office types. Among these classes, four types of Mono, Multi, Mass-rigid, and Mass-flex are based on Duffy’s category and, respectively, represent the Cellular, the Group, the Open-plan, and the

Landscape office. The last one called, Mobile type represents the reversible office concepts. All types are considered based on square plan shape with two states of core positions; central core and side core. The argued details in this regard are provided in the Chapter 4.2 and the results of the investigation are summarized in Table 4.2, Table 4.4, and Table 4.5.

Regarding the aim of this thesis in developing passive retrofit framework for improving façade performance in existing office buildings, the impact area of the proposed façade retrofit framework needed to be clarified. The perimeter areas near the windows have the maximum possibility to be lit with daylight and naturally ventilated. These zones are defined by researchers in various phrases, like, passive zone (King, 2009) or peripheral offices (Reinhart, 2002). The higher the ratio of passive to active areas, the better the total building energy performance will be. Accordingly, this thesis classified office indoor environment in terms of passive zone accessibilities, into internal (deep) zones and peripheral (perimeter) zones. Internal zones in deep plan buildings have minimum access to passive opportunities, thus, need to be lit artificially and ventilated mechanically. However, peripheral zones with a good access to windowed areas (passive zone) of the building, are latest to the natural daylight and ventilation opportunities (Duffy, Cave, and Worthington, 1976, p.145; Reinhart, 2002). In the case of atrium buildings, both internal and peripheral zones have accessibility to passive zone. The main impact area of the proposed Façade Retrofit Framework in this thesis is on peripheral zones. Regarding the peripheral office zones, four different types of office arrangements based-on Duffy's space-depth classification (shallow, medium-depth, deep, and very deep), was considered. The argued details in this regard are provided in the Chapter 4.2.1 and the results of the investigation are structured as the Spatial Comfort Framework, represented in Table 11.

The third step of the process consists of effective passive retrofit actions applicable on façade system of the existing buildings. As the main core of the proposed framework, viable alternatives for distinct problems are discussed. The challenge is in balancing all of these actions. Some actions are in conflict with each other or some of them have

an identical impact. The argued details in this regard are provided in the Chapter 4.3 and the results as the Façade Retrofit Framework are illustrated in the Table 4.6, Table 4.7, and Table 4.8, respectively.

The decision maker's job regarding the different applicable façade retrofit options is to understand the existing building requirements, as well as the constraints, which can affect negatively the building performance even, after the retrofit process and finally, to optimize the decisions. It is essential to avoid overwhelming one single objective on all other influential factors on building performance improvements. Thus, decision making process must be based on a simultaneous consideration among all comfort and energy efficiency requirements and their related criteria in the development of a façade retrofit process. In Turkey, buildings are responsible for a large amount of energy consumption and have tremendous energy saving potential. It is necessary to consider different aspects of any retrofit action before application. To increase yearly retrofit rate, owners should involve in the actions as financiers otherwise relying solely on the amount of governmental contributions will lead to low retrofit rate thus disadvantages of enormous energy consumption will not be demolition. This study tried to introduce a comprehensive retrofit framework in recognizing applicable retrofit measures that are enthusiastic for building owners and make them encourage to involve in the action as financiers.

We think that the proposed framework in this thesis not only helps the user to reach a set of viable performance recommendations as solutions to the existing problems, but also by making a comparable vision among the actions, identifies the interactions between them and clarifies whether they are supplemental or conflicted actions. The non-energy benefits of these actions in the case of office buildings have been also sought out through the study in order to realize to what extent the indoor environment of the different office organizations response effectively to the proposed passive retrofit actions.

## **Limitations of the Study**

The developed framework in this thesis doesn't include the active actions. The proposed passive actions can only offset a part of heating, cooling, and lighting demands, especially in majority of office buildings it might not be very feasible to rely only on passive strategies. However, making a combination among passive and active measures can support using active systems with lower energy technologies. So the combined strategies need to be considered in the future studies. The value and longevity of the retrofit building is currently not considered in the pre-defined characteristic of the building in the chapter 4.1.

## **Recommendations to Future Studies**

We think that it has the potential to be improved to more innovative retrofit concepts such as *Integrated System* retrofit approach, which by involving multiple building systems can enable much greater energy savings by leveraging interactive effects between end use systems, providing an optimum combinations between actions, and consequently enabling lower energy technologies. In the *Integrated System* retrofit approach a complete life cycle energy analysis can be investigated including, operational costs, energy conservation measures, environmental impact like CO<sub>2</sub> emissions, and etc. It can also be improved to a framework usable for retrofitting historical buildings with the objectives of cultural preservation or aesthetic measures including intervention packages of integrated retrofit actions. Finally, it is important to ensure that proposed packages are being met in operations, so it is beneficial to simulate and evaluate the measures through energy simulation tools.

## References

Abdullah, A., Meng, Q., Zhao, L., & Wang, F. (2009). Field study on indoor thermal environment in an atrium in tropical climates. *Building And Environment*, 44(2), 431-436. <http://dx.doi.org/10.1016/j.buildenv.2008.02.011>

Ahlin J, Westlander G (1991) Office spaces and office work - Two perspectives on the office as a workplace. Solna, Sweden: The Swedish National Institute for Working Life (Swedish).

Ahmed, A., Mateo-Garcia, M., Aude, D., and Norberg, A. (2017). *BEST PRACTICE FOR RETROFITTING PUBLIC BUILDINGS IN EUROPE*. RESSEEPE Consortium Partners. Retrieved from <http://file:///C:/Users/Negin/Downloads/RESSEEPEBestPracticeBookfinaldocument.pdf>

Aksamija. (2013). *Sustainable facades. Design methods for high-performance building envelopes*. Bognor Regis: John Wiley & Sons Ltd.

Aksoy UT, Inalli M. (2006). Impacts of some building passive design parameters on heating demand for a cold region. *Building and Environment*; 41 (12):1742e54.

Aldawoud, A. (2008). Thermal performance of courtyard buildings. *Energy and Buildings*, 40(5), 906-910.

Aldawoud, A. (2013). The influence of the atrium geometry on the building energy performance. *Energy Build.* 57, 1–5. [CrossRef]

Al horr, Y., Arif, M., Kafaygiotou, M., Mazroei, A., Kaushik, A., & Elsarrag, E. (2016). Impact of indoor environmental quality on occupant well-being and comfort: A review of the literature. *International Journal Of Sustainable Built Environment*, 5(1), 1-11. <http://dx.doi.org/10.1016/j.ijsbe.2016.03.006>

American Society of Heating and Ventilating Engineers (ASHRAE), Code of minimum requirements, 1924-31.

Anon, (2016). [online] Available at: <http://www.enver.eie.gov.tr/ENVER.portal> [Accessed 20 Dec. 2016]. Dec. 2016].

Architecture 2030. (2013b). “Architecture 2030: The 2030 Challenge.” Accessed January 4. [http://architecture2030.org/2030\\_challenge/the\\_2030\\_challenge](http://architecture2030.org/2030_challenge/the_2030_challenge).

Ashrafian, T., Yilmaz, A., Corgnati, S., & Moazzen, N. (2016). Methodology to define cost-optimal level of architectural measures for energy efficient retrofits of existing detached residential buildings in Turkey. *Energy And Buildings*, 120, 58-77. <http://dx.doi.org/10.1016/j.enbuild.2016.03.074>

ASHVE. 1938. Code of minimum requirements for comfort air conditioning. Heating/Piping/Air Conditioning, April, pp. 276-278.

Atkinson, A. (2011). 3. INTERNATIONAL QUALITY IN CONSTRUCTION SUMMIT “GLOBAL COMPETITION and SUSTAINABILITY. Presentation, Istanbul.

Azar, E., Menassa, C. (2012). Agent-based modelling of occupants’ impact on energy use in commercial buildings. *Journal of Computing in Civil Engineering*, American Society of Civil Engineers, 26(4), 506–518.

Baetens, R., Jelle, B., Thue, J., Tenpierik, M., Grynning, S., Uvsløkk, S., & Gustavsen, A. (2010). Vacuum insulation panels for building applications: A review and beyond. *Energy And Buildings*, 42(2), 147-172. <http://dx.doi.org/10.1016/j.enbuild.2009.09.005>

Baker, N. (2009). *The handbook of sustainable refurbishment*. London: Earthscan.

Baetens, R., Jelle, B., Gustavsen, A., & Grynning, S. (2010). Gas-filled panels for building applications: A state-of-the-art review. *Energy And Buildings*, 42(11), 1969-1975. <http://dx.doi.org/10.1016/j.enbuild.2010.06.019>

Baetens, R., Jelle, B., & Gustavsen, A. (2011). Aerogel insulation for building applications: A state-of-the-art review. *Energy And Buildings*, 43(4), 761-769. <http://dx.doi.org/10.1016/j.enbuild.2010.12.012>



Bahaj, A., James, P., & Jentsch, M. (2008). Potential of emerging glazing technologies for highly glazed buildings in hot arid climates. *Energy And Buildings*, 40(5), 720-731. <http://dx.doi.org/10.1016/j.enbuild.2007.05.006>

BAYRAM, M., “Merkezi Isıtma ve Sıhhi Sıcak Su Sistemlerinde Isı Giderlerinin Paylaştırılması”, 1.Ulusal Enerji Verimliliği Forumu Bildiriler Kitabı, İstanbul, s.99-105, 15-16 Ocak 2009.

BAYÜLKEN, Y. ve KÜTÜKOĞLU, H.C., “Yalıtım Sektörü Envanter Araştırması”, İZODER Yayınları, Mayıs 2009.

Bergman, D. (2012). *Sustainable design* (1st ed.). New York: Princeton Architectural.

Bernier, P., Fenner, R. & Ainger, C. (2010) Assessing the Sustainability Merits of Retrofitting Existing Homes. Proceedings of the Institution of Civil Engineers: Engineering Sustainability, 163 (4), pp. 197-207.

Bernstein, H. M., Russo, M. A. (2009). Green building retrofit and renovation: Rapidly expanding market opportunities through existing buildings. Smart Market Report. McGraw Hill Construction.

Bosch, S. J., Pearce, A. R., & Asce, M. (2003). Sustainability in public facilities: Analysis of guidance documents. *Journal of Performance of Constructed Facilities*, 17(1), 9–18.

Burak S. Zinet, Country Baseline Studies Mediterranean Region; Water Wetlands and Climate change, Turkey Baseline Report on Climate Change Mediterranean Regional Roundtable, December 10 /11, 2002, Athens, Greece.

Burck, J., Marten, F., & Bals, C. (2017). *CCPI (Climate Change Performance) Index: Results 2017*. Berlin: Germanwatch & CAN. Retrieved from <https://germanwatch.org/en/download/16484.pdf>.

Burnham, Michael. 2009. "Governors Call for Carbon-Neutral Buildings by 2030 - NYTimes.com."

*New York Times*. July 20. <http://www.nytimes.com/gwire/2009/07/20/20greenwiregovernors-call-for-carbon-neutral-buildings-by-63515.html>.

Burton, S. (2013). *Energy-efficient Office Refurbishment: Designing for Comfort* (1st ed.). New York: Earthscan, p.3.

Brennan, A., Chugh, J.S., and Kline, T. (2002). Traditional versus open office design: A longitudinal study. *Environment and Behavior*, 34(3), 279–99.

Brill, M., Weidemann, S., and BOSTI Associates. (2001). *Disproving Widespread Myths about Workplace Design*. Jasper, IN: Kimball International.

British Council for Offices. (2005). *The impact of office design on business performance* (1st ed.). London: Commission for Architecture & the Built Environment.

Brookes, M.J., & Kaplan, A. (1972). The office environment: Space planning and affective behavior. *Human Factors and Ergonomics in Manufacturing*, 14(5), 373-91.

Caps, R., Beyrichen, H., Kraus, D., & Weismann, S. (2008). Quality control of vacuum insulation panels: Methods of measuring gas pressure. *Vacuum*, 82(7), 691-699. <http://dx.doi.org/10.1016/j.vacuum.2007.10.015>

Carlson, A., & Martinez Arias, A. (2014). *State of the Art Methodology to Assess Energy Facade Retrofits (EFR)*. Presentation, USC University of Southern California.

Clinton Climatic Initiative. 2009. "CCI's ENERGY EFFICIENCY BUILDING RETROFIT PROGRAM."

[http://www2.presidentsclimatecommitment.org/documents/ccitoolkit/CCIs\\_Energy\\_Efficiency\\_Building\\_Retrofit\\_Program.pdf](http://www2.presidentsclimatecommitment.org/documents/ccitoolkit/CCIs_Energy_Efficiency_Building_Retrofit_Program.pdf).

Collard, B.; DeHerde, A. (1997): *Office Building Typology – Architecture and Climate*, Dublin, University College Dublin (Energy Research Group) [http://erg.ucd.ie/mid\\_career/pdfs/tech\\_mod\\_1.pdf](http://erg.ucd.ie/mid_career/pdfs/tech_mod_1.pdf)

Cuce, E., Cuce, P., Wood, C., & Riffat, S. (2014). Toward aerogel based thermal superinsulation in buildings: A comprehensive review. *Renewable And Sustainable Energy Reviews*, 34, 273-299. <http://dx.doi.org/10.1016/j.rser.2014.03.017>

Danielsson, C., & Bodin, L. (2008). Office Type in Relation to Health, Well-Being, and Job Satisfaction Among Employees. *Environment And Behavior*, 40(5), 636-668. <http://dx.doi.org/10.1177/0013916507307459>

Davis, M., Leach, D., and Clegg, C. (2010). THE PHYSICAL ENVIRONMENT OF THE OFFICE: CONTEMPORARY AND EMERGING ISSUES (1st ed.). Leeds: Leeds University Business School. Retrieved from [https://lubswww.leeds.ac.uk/fileadmin/webfiles/cstsd/Documents/The Physical Environment of the Office Davis Leach Clegg 2011.pdf](https://lubswww.leeds.ac.uk/fileadmin/webfiles/cstsd/Documents/The_Physical_Environment_of_the_Office_Davis_Leach_Clegg_2011.pdf)

De Dear, R.J. and Brager, G.S. (2002) ‘Thermal comfort in naturally ventilated buildings: revisions to ASHRAE Standard 5’, *Energy and Buildings*, 34(6): 549-61.

Dixon, T., Eames, M. (2013) Scaling Up: The Challenges of Urban Retrofit. *Building Research & Information*, 41 (5), pp. 499-503

Dixon, T., Britnell, J., Watson, G. B. (2014) ‘City-wide’ or ‘City-blind?’ An Analysis of Emergent Retrofit Practices in the UK Commercial Property Sector. Retrofit 2050 Working Paper WP2014/1.

Douglas, J. (2006) *Building adaptation*, Amsterdam, Boston, London: Butterworth-Heinemann

Duffy, F., Cave, C., and Worthington, J. (1976). *Planning office space*. London: Butterworth Architecture.

Duffy, F & Chandor, M (1983): *The Orbit Study – Information technology and office design*. DEGW/ Eosys, London.

Duffy, F., Powell, K. (1997). *The New Office* (London: Conrad Octopus).

ECSSD, & ECA. (2011). *Tapping the Potential for Energy Savings in Turkey*. World Bank. Retrieved from

<http://documents.worldbank.org/curated/en/838031468122365862/pdf/522100ESW0P1120ASTER0Dec020100FINAL.pdf>.

EIE (2004). Presentation about current energy situation and legislation, Electrical Power Resources Survey and Development Administration. Retrieved from: [http://www.eie.gov.tr/turkce/en\\_tasarrufu/konut\\_ulas/aylik\\_bulten/2004\\_01/bulten\\_subat2.html](http://www.eie.gov.tr/turkce/en_tasarrufu/konut_ulas/aylik_bulten/2004_01/bulten_subat2.html).

Energy Information Administration (EIA). (2012). AEO2012 early release overview. USA.

Energy Information Administration. (2012). *Commercial Buildings Energy Consumption Survey: Energy Usage Summary*. Retrieved from [https://www.eia.gov/consumption/commercial/reports/2012/buildstock/?src=%E2%80%B9%20Consumption%20%20Commercial%20Buildings%20Energy%20Consumption%20Survey%20\(CBECS\)-b4](https://www.eia.gov/consumption/commercial/reports/2012/buildstock/?src=%E2%80%B9%20Consumption%20%20Commercial%20Buildings%20Energy%20Consumption%20Survey%20(CBECS)-b4)

Energylopedia. (2016). *Turkey- Energy Efficiency in Buildings* - [energylopedia.info](http://energylopedia.info). Retrieved 26 September 2017, from <https://energylopedia.info/wiki/Turkey- Energy Efficiency in Buildings>

European Union. Directive 2010/31/EU of the European parliament and of the council of 19 May 2010 on the energy performance of buildings. Official J Eur Communities 2010; Strasbourg

Fang, Y., & Eames, P. (2006). Thermal performance of an electrochromic vacuum glazing. *Energy Conversion And Management*, 47(20), 3602-3610. <http://dx.doi.org/10.1016/j.enconman.2006.03.016>

Fang, Y., Hyde, T., Hewitt, N., Eames, P., & Norton, B. (2010). Thermal performance analysis of an electrochromic vacuum glazing with low emittance coatings. *Solar Energy*, 84(4), 516-525. <http://dx.doi.org/10.1016/j.solener.2009.02.007>

Farid, M., Khudhair, A., Razack, S., & Al-Hallaj, S. (2004). A review on phase change energy storage: materials and applications. *Energy Conversion And Management*, 45(9-10), 1597-1615. <http://dx.doi.org/10.1016/j.enconman.2003.09.015>

- Feng, J., Le, D., Nguyen, S., Tan Chin Nien, V., Jewell, D., & Duong, H. (2016). Silica□ cellulose hybrid aerogels for thermal and acoustic insulation applications. *Colloids And Surfaces A: Physicochemical And Engineering Aspects*, 506, 298-305. <http://dx.doi.org/10.1016/j.colsurfa.2016.06.052>
- Flourentzou, F., Genre, J. and Roulet, C. (2002). TOBUS software — an interactive decision aid tool for building retrofit studies. *Energy and Buildings*, 34(2), pp.193-202.
- Fraunhofer Institute for Building Physics. (2011). *IEA ECBCS Annex46 - German Homepage - Page "IT-Toolkit-Download-Response"*. *Annex46.de*. Retrieved 26 September 2017, from [http://www.annex46.de/tool\\_response-download\\_e.html](http://www.annex46.de/tool_response-download_e.html)
- Fricke, J., Heinemann, U., & Ebert, H. (2008). Vacuum insulation panels—From research to market. *Vacuum*, 82(7), 680-690. <http://dx.doi.org/10.1016/j.vacuum.2007.10.014>
- Fuerst, F., McAllister, P. (2011). Green noise or green value? Measuring the effects of environmental certification on office values. *Real Estate Economics*, 39(1), 45–69.
- Gao, T., Sandberg, L., & Jelle, B. (2014). Nano Insulation Materials: Synthesis and Life Cycle Assessment. *Procedia CIRP*, 15, 490-495. <http://dx.doi.org/10.1016/j.procir.2014.06.041>
- GBPN. (2013). *Turkey Building Code Implementation - Country Summary*. Global Buildings Performance Network (GBPN). Retrieved from [http://www.gbpn.org/sites/default/files/Turkey\\_Country%20Summary\\_0.pdf](http://www.gbpn.org/sites/default/files/Turkey_Country%20Summary_0.pdf)
- Giebeler, G. (2005). *Refurbishment manual*. Basel: Birkhäuser.
- Global Climate Change: Evidence. (2008, June 15). Retrieved October 14, 2017, from <http://climate.nasa.gov/evidence>
- Gursel, I. (2010). *CLIP: Computational Support for Lifecycle Integral Building Performance Assessment* (1st ed.). Wohrmann.
- Hagentoft, C. (2017). Reliability of Energy Efficient Building Retrofitting - Probability Assessment of Performance and Cost (Annex 55, RAP-RETRO). *Energy And Buildings*. <http://dx.doi.org/10.1016/j.enbuild.2017.09.007>

Harrison, A., Wheeler, P., & Whitehead, C. (2004). *The distributed workplace* (1st ed.). London: Spon Press.

Harvey, D. (2012). *A Handbook on Low-Energy Buildings and District-Energy Systems* (1st ed.). Hoboken: Taylor and Francis.

Haynes, B. (2007). Office productivity: a theoretical framework. *Journal of Corporate Real Estate*, 9(2), 97-110. <http://dx.doi.org/10.1108/14630010710828108>.

Hinnells, M. (2008). Technologies to achieve demand reduction and microgeneration in buildings. *Energy Policy*, 36(12), 4427-4433. <http://dx.doi.org/10.1016/j.enpol.2008.09.029>

Huovila, P. (2005). *Performance Based Building*. Technical Research Center of Finland. Retrieved from <https://www.irbnet.de/daten/iconda/CIB6712.pdf>

Hyde, R. (2008). *Bioclimatic Housing: Innovative Designs for Warm Climates*. Sydney: Earthscan.

IPCC (2007). Summary for Policymakers. In: *Climate Change 2007: The Physical Science Basis. Contribution of Working Group I to the Fourth Assessment Report of the Intergovernmental Panel on Climate Change* [Solomon, S., D. Qin, M. Manning, Z. Chen, M. Marquis, K.B. Averyt, M. Tignor and H.L. Miller (eds.)]. Cambridge University Press, Cambridge, United Kingdom and New York, NY, USA. Retrieved October 14, 2017, from [http://www.ipcc.ch/publications\\_and\\_data/ar4/wg1/en/figure-spm-3.html](http://www.ipcc.ch/publications_and_data/ar4/wg1/en/figure-spm-3.html)

IEA. (2013). *Transition to Sustainable Buildings: Strategies and Opportunities to 2050*. Paris: International Energy agency. Retrieved from <http://www.iea.org/Textbase/npsum/building2013SUM.pdf>

IPCC, Climate Change. (2007). *Mitigation of climate change. Working group III contribution to the fourth assessment report of the intergovernmental panel on climate change*. Cambridge University Press.

Jafari, A., & Valentin, V. (2015). Decision-making life-cycle cost analysis model for energy-efficient housing retrofits. *International Journal Of Sustainable Building Technology And Urban Development*, 6(3), 173-187. <http://dx.doi.org/10.1080/2093761x.2015.1074948>

- Jafari, A., & Valentin, V. (2017). An optimization framework for building energy retrofits decision-making. *Building And Environment*, 115, 118-129. <http://dx.doi.org/10.1016/j.buildenv.2017.01.020>
- Jagarajan, R., Abdullah @ Mohd Asmoni, M., YM Lee, J., & Jaafar, M. (2015). An Overview of Green Retrofitting Implementation in Non Residential Existing Buildings. *Jurnal Teknologi*, 73(5). <http://dx.doi.org/10.11113/jt.v73.4324>.
- Jelle, B. (2011). Traditional, state-of-the-art and future thermal building insulation materials and solutions – Properties, requirements and possibilities. *Energy And Buildings*, 43(10), 2549-2563. <http://dx.doi.org/10.1016/j.enbuild.2011.05.015>
- Jonsson, A., & Roos, A. (2010). Evaluation of control strategies for different smart window combinations using computer simulations. *Solar Energy*, 84(1), 1-9. <http://dx.doi.org/10.1016/j.solener.2009.10.021>
- Kabak, M., Köse, E., Kırılmaz, O., & Burmaoğlu, S. (2014). A fuzzy multi-criteria decision making approach to assess building energy performance. *Energy And Buildings*, 72, 382-389. <http://dx.doi.org/10.1016/j.enbuild.2013.12.059>
- Kamiuto, K., Miyamoto, T., & Saitoh, S. (1999). Thermal characteristics of a solar tank with aerogel surface insulation. *Applied Energy*, 62(3), 113-123. [http://dx.doi.org/10.1016/s0306-2619\(99\)00004-5](http://dx.doi.org/10.1016/s0306-2619(99)00004-5)
- kanan, N. (2013). Binalarda Enerji Verimliliği Konusunda Kamu Projeleri-Binalarda Enerji Performansı Belirlenmesi; 100 Kamu Projesi Örneği. *Tesisat Mühendisliği*, 136, 65-70. Retrieved from [http://www1.mmo.org.tr/resimler/dosya\\_ekler/be59f583c68086e\\_ek.pdf?dergi=1371](http://www1.mmo.org.tr/resimler/dosya_ekler/be59f583c68086e_ek.pdf?dergi=1371)
- Karabay, H., & Arıcı, M. (2012). Multiple pane window applications in various climatic regions of Turkey. *Energy And Buildings*, 45, 67-71. <http://dx.doi.org/10.1016/j.enbuild.2011.10.020>

Kim, G. (1999). Interior partitioned layout and daylighting energy performance in office buildings. *Architectural Research*, 1(1), 31-40. Retrieved from [http://file:///C:/Users/Negin/Downloads/DHGCFS\\_1999\\_v1n1\\_31.pdf](http://file:///C:/Users/Negin/Downloads/DHGCFS_1999_v1n1_31.pdf)

King, D. (2009). DESIGN PRIMER PART 1: PASSIVE DESIGN. *Building Sustainable Design*, (01), 47-48. Retrieved from <http://www.douging.co.uk/PDFs/Passive.pdf>

Klotz, L., Horman, M. (2010). Counterfactual analysis of sustainable project delivery processes. *Journal of Construction Engineering and Management*, 136(5), 595–605.

Konstantinou, T. (2014). *Facade Refurbishment Toolbox: Supporting the Design of Residential Energy Upgrades* (PhD.). Delft University of Technology.

Konstantinou, T. (2015). A Methodology to Support Decision-Making Towards an Energy-Efficiency Conscious Design of Residential Building Envelope Retrofitting. *Buildings*, 5(4), 1221-1241. <http://dx.doi.org/10.3390/buildings5041221>

Kurt, H. (2017). Sustainable and Green Finance journey of Turkey. Presentation, Istanbul.

Lam, J. (2000) 'Energy analysis of commercial buildings in subtropical climates', *Building and Environment*, 45(1): 18-22.

Leaman, A., and Bordass, W. (2005). Productivity in Buildings: The Killer Variables. The Usable Buildings Trust.

Lee, E., Selkowitz, S., Bazjanac, V., Inkarojrit, V., & Kohler, C. (2002). *High-Performance Commercial Building Façades*. CA: University of California. Retrieved from <http://eetd.lbl.gov/sites/all/files/publications/lbnl50502.pdf>

Leech, J. A., Nelson, W.C., Burnett, R.T., Aaron, S. & Raizenne, M.E. (2002) It's about time: A comparison of Canadian and American time-activity patterns, *Journal of Exposure Science and Environmental Epidemiology*, 12(6):427–432.

Libby, J. (2001). *Advanced acoustic glazing - the latest developments in sound and vision*. Coventry: Centre for Window and Cladding Technology. Retrieved from [http://www.bath.ac.uk/cwct/cladding\\_org/gib99/paper15.pdf](http://www.bath.ac.uk/cwct/cladding_org/gib99/paper15.pdf)



Lysen, E. (1996). The Trias Energica: *Solar Energy Strategies for Developing Countries*. In: A. Goetzberger and J. Luther (eds.). Proceedings of the EUROSUN Conference; 16–19 September, Freiburg, Germany: DGS Sonnenenergie Verlags-GmbH.

Ma, Z., Cooper, P., Daly, D. and Ledo, L. (2012). Existing building retrofits: Methodology and state-of-the-art. *Energy and Buildings*, 55, pp.889-902.

Mangan, S., & Koçlar Oral, G. (2016). Life cycle assessment of energy retrofit strategies for an existing residential building in Turkey. *A/Z : ITU Journal Of Faculty Of Architecture*, 13(2), 143-156. <http://dx.doi.org/10.5505/itujfa.2016.26928>

Meir, I. A., Pearlmutter, D., & Etzion, Y. (1995). On the microclimatic behavior of two semi-enclosed attached courtyards in a hot dry region. *Building and Environment*, 30(4), 563-572.

Menassa, C., Mangasarian, S., Asmar, M. E., & Kirar, C. (2012). Energy consumption evaluation of U.S. Navy LEED-certified buildings. *Journal of Performance of Constructed Facilities*, 26(1), 46–53.

Menassa, C., Baer, B. (2014). A framework to assess the role of stakeholders in sustainable building retrofit decisions. *Sustainable Cities and Society*, 10, 207-221. <http://dx.doi.org/10.1016/j.scs.2013.09.002>

McElroy, J., and Morrow, P. (2010). Employee reactions to office redesign: A naturally occurring quasi-field experiment in a multi-generational setting. *Human Relations*, 63(5), 609-636. <http://dx.doi.org/10.1177/0018726709342932>

McGraw-Hill Construction. (2010). *Energy Efficiency Trends in Residential and Commercial Buildings*. U.S. Department of Energy. Retrieved from [https://www1.eere.energy.gov/buildings/publications/pdfs/corporate/building\\_trends\\_2010.pdf](https://www1.eere.energy.gov/buildings/publications/pdfs/corporate/building_trends_2010.pdf)

Mihalakakou, G. (2002). On the use of sunspace for space heating/cooling in Europe. *Renewable Energy*, 26(3), 415-429. [http://dx.doi.org/10.1016/s0960-1481\(01\)00138-0](http://dx.doi.org/10.1016/s0960-1481(01)00138-0)

Ministry of Energy (2007). Proceedings Report of Ministry of Energy, [www.enerji.gov.tr](http://www.enerji.gov.tr), 2007.

Muhaisen, A. S. (2006). Shading simulation of the courtyard form in different climatic regions. *Building and Environment*, 41(12), 1731-1741.

Muhaisen, A. S., & Gadi, M. B. (2006). Shading performance of polygonal courtyard forms. *Building and Environment*, 41(8), 1050-1059.

NASA: Global Climate Change, Images of change. (2016). Retrieved October 14, 2017, from <https://climate.nasa.gov/images-of-change?id=582#582-irans-lake-urmia-changes-color>

National Park Service. 2013. "National Register of Historic Places Fundamentals: How to List a Property in the National Register -- National Register of Historic Places Official Website-- Part of the National Park Service." Accessed January 4. [http://www.nps.gov/nr/national\\_register\\_fundamentals.htm](http://www.nps.gov/nr/national_register_fundamentals.htm).

Ochoa, C., & Capeluto, I. (2009). Advice tool for early design stages of intelligent facades based on energy and visual comfort approach. *Energy And Buildings*, 41(5), 480-488. <http://dx.doi.org/10.1016/j.enbuild.2008.11.015>

Olgay, V, Seruto, C. (2010). Whole-building retrofits: a gateway to climate stabilization, *ASHRAE Transactions* 116 (Part 2) , p.244–251.

Palmer, A., & Lewis, M. (1977). *Planning the Office Landscape* (p. 4). McGraw-Hill.

Paris-Newton, J., Prokofieva, E., & Henry, N. (2015). Improvement of Thermal Insulation of Residential Buildings' Facades Via Acoustic Insulation. *Energy Procedia*, 78, 3446-3451. <http://dx.doi.org/10.1016/j.egypro.2015.11.134>

Passe, U., & Nelson, R. (2013). Constructing Energy Efficiency: Rethinking and Redesigning the Architectural Detail. *Journal Of Architectural Engineering*, 19(3), 193-203. [http://dx.doi.org/10.1061/\(asce\)ae.1943-5568.0000108](http://dx.doi.org/10.1061/(asce)ae.1943-5568.0000108)

PickardChilton. (2012). *The Office Building of the Future*. Seattle, WA, US: Pickard Chilton.

Poel, B., van Cruchten, G., and Balaras, C.A. (2007). Energy performance assessment of existing dwellings, *Energy and Buildings*, Vol. 39, pp. 393-403

Poirazis, H. (2006). *Double Skin Façades: A Literature Review*. Lund: Department of Architecture and Built Environment, Division of Energy and Building Design, Lund University. Retrieved from [http://www.ecbcs.org/docs/Annex\\_43\\_Task34-Double\\_Skin\\_Facades\\_A\\_Literature\\_Review.pdf](http://www.ecbcs.org/docs/Annex_43_Task34-Double_Skin_Facades_A_Literature_Review.pdf)

Preiser, W., and Vischer, J. (2005). *Assessing building performance* (1st ed.). Oxford: Butterworth-Heinemann. Retrieved from [http://www.gci.org.uk/Documents/architecture-ebook-assessing-building-performance\\_.pdf](http://www.gci.org.uk/Documents/architecture-ebook-assessing-building-performance_.pdf)

Property Council Australia (PCA) and Arup (2009) *Existing Buildings, Survival Strategies: A Toolbox for Re-Energizing Tired Assets*, Thousand Oaks, Ca: Sage.

Rajapaksha, U., Hyde, R., & Groenhout, N. (2013). Design Solution Sets for Bio-climatic Retrofit. In R. Hyde, N. Groenhout, F. Barram & K. Yeang, *Sustainable Retrofitting of Commercial Buildings: Warm Climates* (1st ed., pp. 61-88). Routledge.

Raji, B., Tenpierik, M., and van den Dobbelsteen, A. (2017). Early-Stage Design Considerations for the Energy-Efficiency of High-Rise Office Buildings. *Sustainability*, 9(4), 623. <http://dx.doi.org/10.3390/su9040623>

Rey, E. (2004). Office building retrofitting strategies: multi-criteria approach of an architectural and technical issue. *Energy and Buildings*, 36(4), 367-372. <http://dx.doi.org/10.1016/j.enbuild.2004.01.015>.

Reffat, R., & Harkness, E. (2001). Environmental Comfort Criteria: Weighting and Integration. *Journal Of Performance Of Constructed Facilities*, 15(3), 104-108. [http://dx.doi.org/10.1061/\(asce\)0887-3828\(2001\)15:3\(104\)](http://dx.doi.org/10.1061/(asce)0887-3828(2001)15:3(104))

Reinhart, C. (2002). Effects of interior design on the daylight availability in open plan offices. *National Research Council Canada*, 45374. Retrieved from [http://citeseerx.ist.psu.edu/viewdoc/download;jsessionid=43EDA380AD37AA96C58971EC\\_AFAD7376?doi=10.1.1.115.1693&rep=rep1&type=pdf](http://citeseerx.ist.psu.edu/viewdoc/download;jsessionid=43EDA380AD37AA96C58971EC_AFAD7376?doi=10.1.1.115.1693&rep=rep1&type=pdf)

Richter, W., Seifert, J., Gritzki, R., & Rösler, M. (2003). Bestimmung des realen Luftwechsels bei Fensterlüftung aus energetischer und bauphysikalischer Sicht, Fraunhofer IRB Verlag, Stuttgart.

Roulet C-A. (2001). Indoor environment quality in buildings and its impact on outdoor environment. *Energy Buildings*; 33(3):183e91

Saaty, Thomas L. (1972). Priorities and Hierarchies: Eigenvalue Structure, working paper, University of Pennsylvania. Retrieved from

Safarzadeh, H., and Bahadori, M. (2005). Passive cooling effects of courtyards. *Building And Environment*, 40(1), 89-104. <http://dx.doi.org/10.1016/j.buildenv.2004.04.014>

Sağlam, N., Yılmaz, A., Becchio, C., & Corgnati, S. (2017). A comprehensive cost-optimal approach for energy retrofit of existing multi-family buildings: Application to apartment blocks in Turkey. *Energy And Buildings*, 150, 224-238. <http://dx.doi.org/10.1016/j.enbuild.2017.06.026>

Santamouris, M., Sfakianaki, A., & Pavlou, K. (2010). On the efficiency of night ventilation techniques applied to residential buildings. *Energy And Buildings*, 42(8), 1309-1313. <http://dx.doi.org/10.1016/j.enbuild.2010.02.024>

SARI, S. (2014). *Turkey 2015*. *Www-pub.iaea.org*. Retrieved 28 September 2017, from [http://www-pub.iaea.org/MTCD/Publications/PDF/CNPP2015\\_CD/countryprofiles/Turkey/Turkey.htm](http://www-pub.iaea.org/MTCD/Publications/PDF/CNPP2015_CD/countryprofiles/Turkey/Turkey.htm)

Shaviv, E., Yezioro, A., & Capeluto, I. (2001). Thermal mass and night ventilation as passive cooling design strategy. *Renewable Energy*, 24(3-4), 445-452. [http://dx.doi.org/10.1016/s0960-1481\(01\)00027-1](http://dx.doi.org/10.1016/s0960-1481(01)00027-1)

Shahrestani, M., Yao, R., and Cook, G. (2013). A review of existing building benchmarks and the development of a set of reference office buildings for England and Wales. *Intelligent Buildings International*, 6(1), 41-64. <http://dx.doi.org/10.1080/17508975.2013.828586>

Shekar, V., & Krarti, M. (2017). Control strategies for dynamic insulation materials applied to commercial buildings. *Energy And Buildings*, 154, 305-320. <http://dx.doi.org/10.1016/j.enbuild.2017.08.084>

Schittich, C. (2011). *Work environments*. Munich: Edition Detail-Institut für internationale Architektur-Dokumentation.

SCHULTZ, J., JENSEN, K., & KRISTIANSEN, F. (2005). Super insulating aerogel glazing. *Solar Energy Materials And Solar Cells*, 89(2-3), 275-285. <http://dx.doi.org/10.1016/j.solmat.2005.01.016>

Scofield, J. H. (2009). Do LEED-certified buildings save energy? Not really. *Energy and Buildings*, 41(12), 1386–1390.

Seddigh, A., Berntson, E., Danielson, C. B., & Westerlund, H. (2014). Concentration requirements modify the effect of office type on indicators of health and performance. *Journal of Environmental Psychology*, 38, 167-174.

Shea, T., Pettit, T., and De Cieri, H. (2011). *Work environment stress: The impact of the physical work environment on psychological health. A Snapshot Review* (1st ed.). Australian Centre for Research in Employment and Work (ACREW), Monash University. Retrieved from [http://www.iscrr.com.au/\\_data/assets/pdf\\_file/0007/297763/Work-Environment-and-Mental-Health-Full-Report-1211.pdf](http://www.iscrr.com.au/_data/assets/pdf_file/0007/297763/Work-Environment-and-Mental-Health-Full-Report-1211.pdf)

Sims, B., & Bakens, W. (2002). CIB Performance Based Building (PeBBu) Thematic Network. In *International Council for Research and Innovation in Building and Construction Rotterdam The Netherlands*. Rotterdam. Retrieved from <http://www.irbnet.de/daten/iconda/CIB9147.pdf>

Smith, D., Maskara, A., & Boes, U. (1998). Aerogel-based thermal insulation. *Journal Of Non-Crystalline Solids*, 225, 254-259. [http://dx.doi.org/10.1016/s0022-3093\(98\)00125-2](http://dx.doi.org/10.1016/s0022-3093(98)00125-2)

Smith-Jackson, T.L., and Klein, K.W. (2009). Open-plan offices: Task performance and mental workload. *Journal of Environmental Psychology*, 29(2), 279–89.

Steadman, P., H. R. Bruhnes, and P. A. Rickaby. 2000c. "An introduction to the national Non-Domestic Building Stock database." *Environmental and planning B: Planning and design* 27: 3-10.

Stratton, M. (1997). *Structure and style* (1st ed.). London [etc.]: E & FN Spon.

Straube, J.F.; Burnett, E.F.P. (2005). *Building Science for Building Enclosures*; Building Science Press: Westford, MA, USA. [[Google Scholar](#)]

Szalay, Z., Kiss, I., Gelesz, A., & Reith, A. (2015). A SYSTEMIC PUBLIC BUILDING AND DISTRICT RETROFITTING METHODOLOGY. In *PLEA2015 Architecture in (R) Evolution - 31st International PLEA Conference*. Bologna. Retrieved from [http://file:///C:/Users/Negin/Downloads/pu\\_638%20\(1\).pdf](http://file:///C:/Users/Negin/Downloads/pu_638%20(1).pdf)

Tabesh, T., & Sertyesilisik, B. (2016). An Investigation into Energy Performance with the Integrated Usage of a Courtyard and Atrium. *Buildings*, 6(2), 21. <http://dx.doi.org/10.3390/buildings6020021>

Tablada, A., Blocken, B., Carmeliet, J., De Troyer, F., & Verschure, H. (2005). The influence of courtyard geometry on air flow and thermal comfort: CFD and thermal comfort simulations.

Taşpınar, F., Çelebi, N. and Tutkun, N. (2013) Forecasting of daily natural gas consumption on regional basis in Turkey using various computational methods. (Economic Growth And Natural Gas Consumption In Turkey: A Bound Test Approach (1977-2008))

Tata Steel. (2012). *Colorcoat technical paper: acoustic performance of pre-finished steel cladding material*. London. Retrieved from [https://www.tatasteelconstruction.com/static\\_files/Tata%20Steel/content/Tools%20&%20Resources%20articles/Download%20Zone/Colorcoat/Colorcoat\\_Acoustic\\_TechPaper\\_FINAL.pdf](https://www.tatasteelconstruction.com/static_files/Tata%20Steel/content/Tools%20&%20Resources%20articles/Download%20Zone/Colorcoat/Colorcoat_Acoustic_TechPaper_FINAL.pdf)

The IPCC-AR5. (2013). *The fifth IPCC assessment report, AR5*. IPCC. Retrieved from <http://www.ipcc.ch/>

Turkish Statistical Institute. (2016, April 18). *Greenhouse Gas Emissions Inventory, 2014*, Retrieved October 14, 2017, from <http://www.turkstat.gov.tr/PreHaberBultenleri.do?id=21582>

U.S. Department of Energy. (2010). "Building Technologies Program: Envelope Systems R&D." Accessed November 29. [http://www1.eere.energy.gov/buildings/systems\\_rd.html](http://www1.eere.energy.gov/buildings/systems_rd.html).

Ürge-Vorsatz, D., Cabeza, L., Serrano, S., Barreneche, C., Petrichenko, K. (2015). Heating and cooling energy trends and drivers in buildings. *Renew. Sustain. Energy Rev.* 41, 85–98. Copyright 2015, with permission from Elsevier.

Van Meel, J. (2000). *The European office: Office design and national context* (Doctoral Thesis). TU Delft. [uuid:8718d3a3-f679-4b4a-9e1a-40165c59ca4c](http://dx.doi.org/10.1108/14630010110811661).

Van Meel, J., and Vos, P. (2001). Funky offices: Reflections on office design in the 'new economy'. *Journal of Corporate Real Estate*, 3(4), 322-334. <http://dx.doi.org/10.1108/14630010110811661>

Vassigh, S., & Chandler, J. (2012). *Building systems integration for enhanced environmental performance*. Boca Raton, Fla: J. Ross.

Vischer, J.C. (1996). *Workspace Strategies: Environment as a Tool for Work*. New York: Chapman and Hall.

Vischer, J.C., McCuaig, A., Nadeau, N., Melillo, M., & CastonguayVien, S. (2003). Mission impossible or mission accomplished? Results of an evaluation of universal planning in offices. Unpublished final report, Groupe de recherche sur les environnements de travail, Université de Montréal, Montreal.

Vischer, J.C. (2005). *Space Meets Status: Designing Workplace Performance*. Oxon: Routledge.

Vischer, J. (2008). Towards an Environmental Psychology of Workspace: How People are Affected by Environments for Work. *Architectural Science Review*, 51(2), 97-108. <http://dx.doi.org/10.3763/asre.2008.5114>

Wagner A, Gossauer E, Moosmann C, Gropp T, Leonhart R (2007) “Thermal comfort and workplace occupant satisfaction-results of field studies in german low energy office buildings.” *Energy Build.*, 39(7): 758–769.

Wagner, L., Ross, I., Foster, J., & Hankamer, B. (2016). Trading Off Global Fuel Supply, CO2 Emissions and Sustainable Development. *PLOS ONE*, 11(3), e0149406. <http://dx.doi.org/10.1371/journal.pone.0149406>

Wong, I., Eames, P., & Perera, R. (2007). A review of transparent insulation systems and the evaluation of payback period for building applications. *Solar Energy*, 81(9), 1058-1071. <http://dx.doi.org/10.1016/j.solener.2007.04.004>

Weiss, J., Dunkelberg, E., Vogelpohl, T. (2012) Improving policy instruments to better tap into home owner refurbishment potential: Lessons learned from a case study in Germany. *Energy Policy*, 44, pp. 406–415.

Wilson, C., Crane, L., Chryssochoidis, G. (2014) Why do people decide to renovate their homes to improve energy efficiency? Working paper 160. Norwich, UK: Tyndall Centre for Climate Change Research.

Xing, Y., Hewitt, N., & Griffiths, P. (2011). Zero carbon buildings refurbishment—A Hierarchical pathway. *Renewable And Sustainable Energy Reviews*, 15(6), 3229-3236. <http://dx.doi.org/10.1016/j.rser.2011.04.020>

Yigitcanlar, T. (2016). *Technology and the City: Systems, Applications and Implications*. New York: Routledge.

Yik, F., & Bojić, M. (2006). Application of switchable glazing to high-rise residential buildings in Hong Kong. *Energy And Buildings*, 38(5), 463-471. <http://dx.doi.org/10.1016/j.enbuild.2005.08.006>

Yohanis YG, Norton B. (2002). Useful solar heat gains in multi-zone non-domestic buildings as a function of orientation and thermal time constant. *Renewable Energy*; 27(1):87e95.

Yudelson, Jerry. (2009). *Greening Existing Buildings*. 1st ed. McGraw-Hill Professional.



Yudelson, J. (2010). Greening existing buildings. New York: McGraw Hill – A green source book.

Zhou, D., Zhao, C., & Tian, Y. (2012). Review on thermal energy storage with phase change materials (PCMs) in building applications. *Applied Energy*, 92, 593-605.  
<http://dx.doi.org/10.1016/j.apenergy.2011.08.025>





## APPENDIX A

### SPATIAL COMFORT FRAMEWORK FOR PERIPHERAL OFFICE ZONES

#### SC.1. Reducing penetration of cold down draughts

The height of the window surface, temperature of the inner windowpane, and the closeness of occupant to window are influential factors in creation of cold down draughts or downdraft discomfort in the room. Improving glazing performance instead of raising the temperature by using mechanical perimeter heating systems will have a significant effect in lowering down draft effect (Hoffmann, et.al.2012).

SC.1.1. Decreasing the height of windows: the maximum window height from sill should not exceed 2.5 meter and the minimum sill height needs to be at least 1 meter (Petermann and Menchaca, 2017).

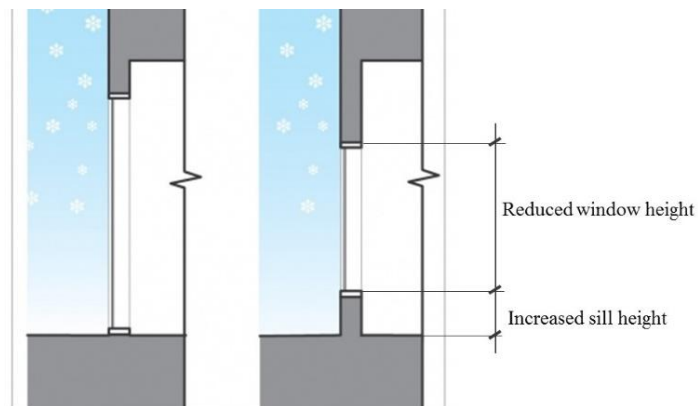

**Figure A.1.** Reducing downdraft effect by reducing window height (Petermann and Menchaca, 2017).

SC.1.4. Placing the radiators on the external walls: the impacts of cold draughts can be offset by countering warm-up air flows of radiator near the glazed area and cold draught flows. This action will increase indoor mean temperature rates. To maximize the effect of counteracting warm and cold flows, it is proposed that the radiator be larger than the window width (Duffy, et.al., 1988, p.145).

## **SC.2. Reducing cold radiation effect on occupants near the windows**

The surface temperatures in winter for a building with single glazing, will be a few degrees cooler than the air temperature. Cooler surface temperatures will provide lower perceived temperatures for the occupants. Two main factors of surface area and the closeness of the occupant to window are discriminant in cold radiation effect (Duffy, et.al., 1988, p.143). This effect can be reduced by the proposed alternatives in TC.2, TC.3, TC.4, and TC.5 in the façade retrofit framework section of this thesis.

SC.2.1. Reducing total amount of glazing: in a study by Petermann and Menchaca (2017) three different window dimension have been taken into account to investigate the influence of window size on the intensity of cold radiation discomfort in office buildings. The thermal comfort in their study is assessed based on PPD (predicted percentage dissatisfied). PPD percentage shows thermally dissatisfied occupants for a given set of conditions. According to ASHRAE Standard 55, in a space with the PPD of 10% or lower, occupants will feel comfortable. Accordingly, for their study, as seen in below, case 1 with minimized window size and increased sill height and with the PPD of 9.4% provided the optimal thermal comfort condition.

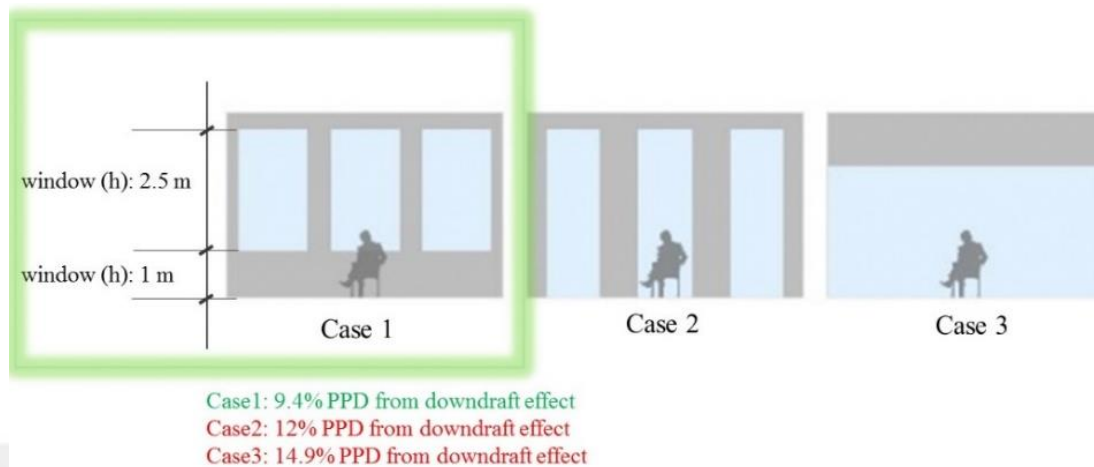

**Figure A.2.** Reducing cold radiation effect by increasing sill height (Petermann and Menchaca, 2017).

SC.2.2. Increasing the sill height: adding a window sill could mitigate the need to install perimeter radiant heating system. In an experimental study by Petermann and Menchaca (2017) it's proven that the presence of a well-insulated sill has a very effective role in improving thermal comfort even, with an insufficient glazing type.

SC.2.5. Redirecting extracted heat of artificial light from the internal parts to peripheral area: some of the heating loads created by artificial lighting fittings can be extracted through the fittings before entering the space and redirected to the peripheral areas of office, which demand heating loads in winter (Duffy, et.al., 1988, p.146).

### SC.3. Providing indirect airflows

Winter and summer requirements for natural ventilation is always along with conflicts. Air flows and cold draughts in winter should be limited and direct away from the occupants' workstations (Duffy, et.al., 1976, p.144).

SC.3.1. Using small openings at high level: in winter to provide natural ventilation, while limiting the inflowing of cold air and indirect draughts, placing small openings at high level of window box is good alternative (Duffy, et.al., 1976, p.144).

SC.3.2. Reducing thermal radiation of heated room surfaces: in the case of using floor or ceiling heating systems, avoiding high thermal radiation should be taken into account. If there is heated floor system, the maximum temperature of the floor should be maximum 25°C (occasionally, 27 °C). The thermal radiation at head level can be a little bit more than foot level. If ceiling heating system is used as thermal source, the maximum thermal radiation should not exceed 30°C (regarding the room height).

SC.3.3. Using high admittance surfaces: it is proposed to reduce high temperatures in peripheral offices due to the solar heat gains, furniture with high admittance surfaces be used (Kelles, 1972).

SC.3.4. Using partially open windows as winter ventilators: the most suitable passive ventilation options in winter are windows that can be kept partially open, instead of those, which need to be closed and opened during the day (Duffy, et.al., 1988, p.144). The sound insulation in these types of ventilator openings are also well insulated, because of the presence of a secondary glazing and an air gap between two glass panes (Søndergaard, Morten, Hansen & DELTA, 2017).

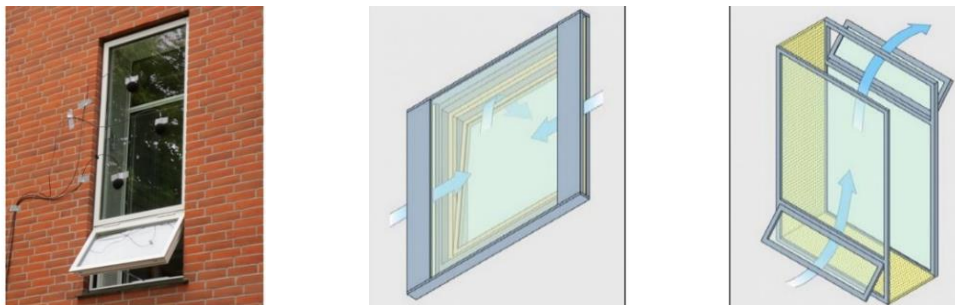

**Figure A.3.** Partially open windows as winter ventilators (Søndergaard, Morten, Hansen & DELTA, 2017).

#### **SC.4. Providing natural ventilation**

SC.4.1. Using large openings at lower level: for summer ventilation typically, large windows at lower parts are good choice and to maximize the effect in warm days, they should be placed in more than one wall. However, this action might disturb papers on workstations, thus, the paperwork zones need to be redistributed or have a proper control on paperweights (Duffy, et.al., 1976, p.144).

#### **SC.5. Reducing relative humidity**

Control of humidity rates in naturally ventilated buildings is rather challenging issues, however, this depends on the local climate. In temperate climates, which does not see very high temperature and humidity levels during the summer period, this challenge become more faded (Price Engineer, 2011).

#### **SC.6. Reducing vertical temperature gradients**

To eliminate the stuffy feelings, the vertical temperature gradients of space must be kept in low rates. Stiffness feelings are the result of slightly high temperatures in head level than foot levels. Consequently, with the increasing height of the ceiling, temperature increasing must be avoided. As Duffy et al., (1976) indicates, the increase in temperature per meter in height of room should be less than 1.5 °C /m.

#### **SC.7. Optimizing external glazed percentage in peak solar radiation hours**

The main source of heating discomfort in peripheral offices is inappropriate control of solar radiation amount. Firstly, the glazing amount of the external glazed wall needs to be retrofitted to achieve optimum window-to-wall ratio (min 20% - max 60%) as discussed in the literature part in pages 29-30. Secondly, peripheral offices compared to internal offices receive a great amount of direct solar radiation, which need to be adjusted by occupants during the day in form of internal or external controls like blinds, rollers, and etc. The typical heat gains for peripheral offices in relation to the received daylight amount are illustrated in Figure A.4 by BRS Digest.

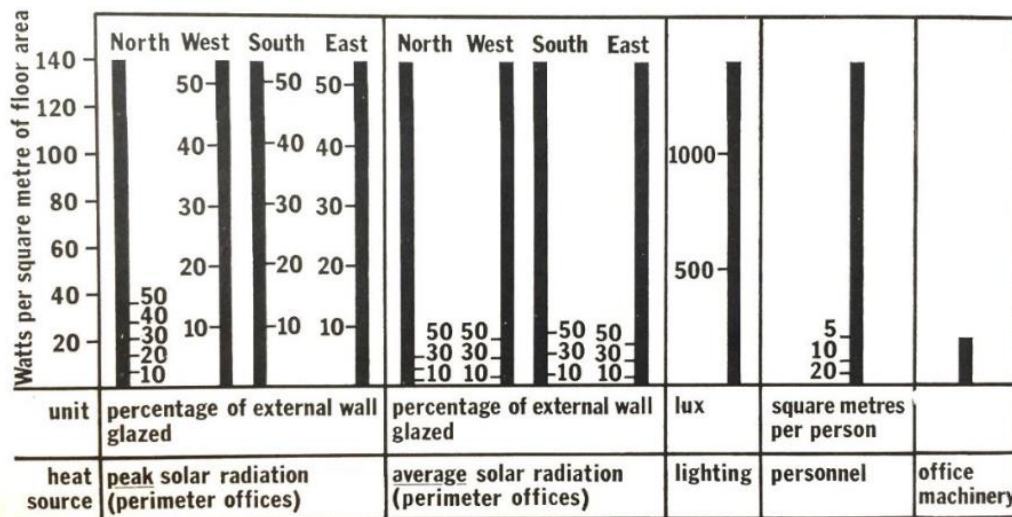

**Figure A.4.** Heat gains in peripheral offices with peak and average solar radiation and glazing percentage (Duffy et.al, 1976, p.144).

SC.7.3. Using automated or manually controlled blinds in southern façade: According to Reinhart (2002), using automated or manually controlled blinds in southern façade, will save energy almost 50% to 60% in a peripheral office zone, however, electric load savings for internal parts with minimum accessibilities to daylight are usually low.

### SC.8. Reducing internal noise of passive ventilation

In natural ventilation strategies acoustically attenuated inflow and outflow ducts will have a great impact on reduction of internal noise levels.

SC.8.1. Adding acoustical absorber baffles in inlet and outlet vents: to manage undesired noise of ventilation ducts, treating inlet and outlet vents with acoustic baffles is proposed (Price Engineer, 2011). The sound attenuation of acoustical absorbers in ventilation is almost five times greater than partially opened windows (Harvey, 2012, p.225).



SC.8.2. Using attenuated vent openings: To have a passive ventilation, simultaneously, reduced external noise, attenuated vent openings are preferable options (Conlan, Harvie-Clark, and Apex Acoustics, 2017).

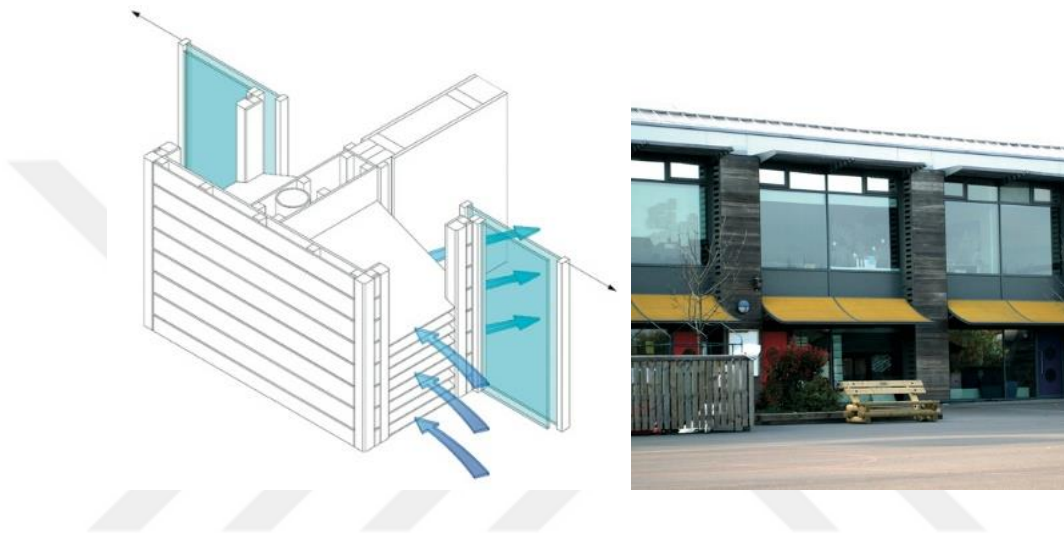

**Figure A.5.** External Vent Box and the incorporated façade (machacoustics.com).

SC.8.3. Using attenuated double windows: attenuated openings are dual glazing windows comprised of top and bottom hung or side hung openings. The air gap between two glass panes in some cases can be include sliding barrier, which prevents direct air flows from outside to inside (Figure A.6). As seen in section SC.3.3, these openings are good alternatives for winter passive ventilation (Conlan, Harvie-Clark, and Apex Acoustics, 2017). These windows can attenuate outside noise up to 25 dB (Harvey, 2012, p.225).

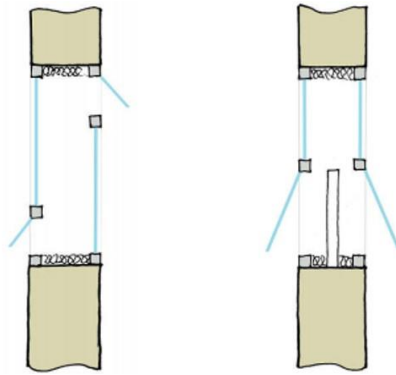

**Figure A.6.** Attenuated double windows (Conlan, Harvie-Clark, and Apex Acoustics, 2017).

SC.8.4. Adding external attenuator connected to the window: the external sound attenuator with the sound attenuation ability of up to 21 dB can be mounted to façade by connecting to the operable window (Conlan, Harvie-Clark, and Apex Acoustics, 2017).

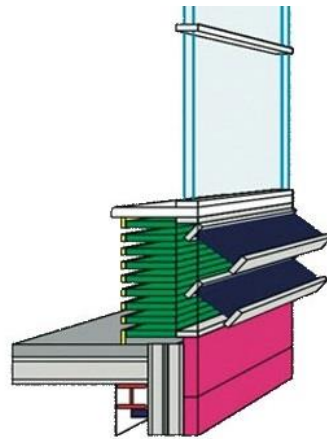

**Figure A.7.** Attenuator Box located under a window, external vent used to control air flow (<http://www.machacoustics.com>).

## **APPENDIX B**

### **SPATIAL COMFORT FRAMEWORK FOR INTERNAL OFFICE ZONES**

The windowless areas in offices are defined as internal offices in many research works. Practically, there does not exist any distinct boundary between peripheral area and internal area.

#### **SC.9. Reducing artificial lighting heat loads**

The majority of large heating loads in internal areas of office buildings are due to artificial lighting and other electronic equipment. Natural ventilation even will not be adequate to remove this heat from the internal parts.

SC.9.1. Extracting warm air through lighting fittings before entering in space: a part of lamps' heat can be prevented before entering the space by extracting it through the fittings (Duffy, et.al., 1976, p.146).

SC.9.2. Applying displacement ventilation: through the suspended ceiling, the space above the ceiling can be used as plenum to create the cycle of supplying cool air and extracting warm air from the internal spaces (Duffy, et.al., 1976, p.146).

#### **SC.10. Providing cool supply air flows**

According to the reviewed literature (Price Engineer, 2011; Duffy, et al., 1988, p.146; and Shahzad, Brennan, Theodossopoulos, Hughes, & Calautit, 2015) following options can be applied in order to create fresh air flows in internal offices:

- Applying cross-flow ventilation
- Using displacement ventilation by implementing operable windows
- Using combined supply-extract ceiling diffusers
- Dividing office space into supply and extract zones
- Placing ceiling supply-extract air diffusers closely

SC.10.1. Applying cross-flow ventilation: the effective natural ventilation for open-plan zones is the cross-flow ventilation. To implement this action, openings must be placed at the opposite sides, thus, the air flows from a zone with high pressure will pass to the zone with low pressure condition, as seen in the below figure (Price Engineer, 2011).

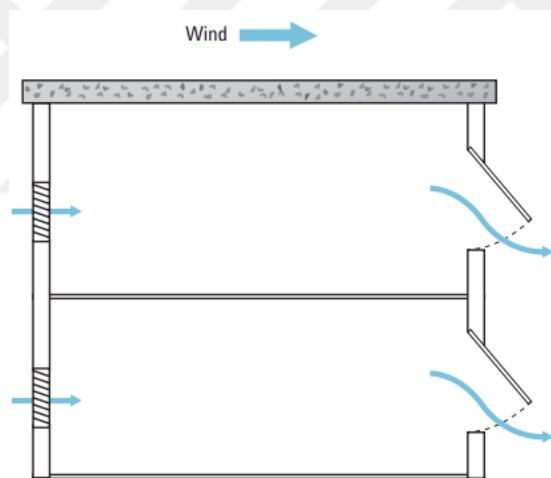

**Figure B.1.** Cross-flow ventilation (Price Engineer, 2011).

SC.10.2. Using displacement ventilation by implementing operable windows: the operation of both central air conditioning system and operable windows provides high comfort levels but will result much higher energy consumption. It is better in terms of both comfort and energy efficiency, to use displacement ventilation as the main source of fresh air and temperature control and applying few operable windows in partitioned open offices (Shahzad, et al., 2015).

SC.10.3. Using combined supply-extract ceiling diffusers: in this type of supply-extract process, the warm air is extracted in the center of diffuser and supplying occurs from their edges.

SC.10.4. Dividing office space into supply and extract zones: another solution in internal open spaces is dividing interior spaces into two supply and extract areas. The air is supplied in one zone and extracted from the other parts (Duffy, et.al., 1988, p.146).

SC.10.5. Placing supply-extract air diffusers closely: the provision of equal air movements in open plan offices without partitions is a challenging issue. As regards the presence of fewer walls in open-plan offices, the extract channels need to be placed in ceiling part. This means that the supply-extract air circulation will need to pass whole part of the room. To eliminate this problem, the supply-extract diffusers must be located close to each other while directing the supply of air away from the extract channel (Duffy, et.al., 1988, p.146).

### **SC.11. Reflecting heat into the space**

The heat gains from lighting fittings are a steady heating type, which can be used by redirecting it by ceiling into the space in a equal rates for all part of the internal spaces (Duffy, et.al., 1976, p.146).

SC.11.1. Extracting warm air through the space above the ceiling: the space above the ceiling can be utilized as a plenum to store the extracted warm air from artificial lighting and then retransferring it back into the space if needed.

### **SC12. Increasing the impact range of natural daylight in internal office zones**

The natural daylight can be distributed in internal zones by reducing height of partitions, slopping down the ceiling near the windowed area, and using light directing daylight systems.

SC.12.1. Reducing partitions' height: 20 inches reduction in the partition height will have double effect in saving energy. By lowering the partition height between centeric interior spaces and peripheral zones, the centric zone will have the opportunity to access to a partial outside view (Reinhart, 2002).

SC.12.2. Slopped down ceilings for rooms with smaller vision areas: refer to VC.4 in the façade retrofit framework.

SC.12.3. Using light-directing pipes: refer to VC.2 and VC.3 sections

SC.12.4. Adding desk lamps or dimmer switches: in providing user control task lighting, desk lamps and dimmer switches are good alternatives (Schittich, 2011, p.42).

### **SC.13. Reducing internal reflection of sound**

Zhang, Kang, and Jiao (2012) found that in comparison to the other physical environmental factors in open-plan offices, workers are mostly less satisfied with noise and the lack of acoustic privacy. Almost 50% of the interviewees remarked the most annoying sounds as noises from outside, ventilation systems, office equipment, and keyboard typing.

SC.13.1. Separating zones based on noise and work patterns: grouping all occupants of the office who require privacy into one area with screens is proposed. Typically, near the walls and corners are noisy than positions in the middle of the office/ more sensitive working positions should be placed in the middle zones (Duffy, et.al., 1976, pp.133-139).

SC.13.2. Providing buffer zones: To prevent the sound transmittance from high dense zones to quiet low-dense zones, circulation routs as buffer zones must be provided between high and low dense occupied spaces (Duffy, et.al., 1976, pp.133-139).

SC.13.3. Using high sound-absorbing ceiling material: For a partitioned open-plan office to have good acoustic conditions, Passero, & Zannin (2012) propose using high sound-absorbing materials on finishing surface of the ceiling.



**Figure B.2.** Open-plan office with suspended acoustic ceiling (Schittich, 2011, p.44).

SC.13.5. Masking internal noise: Vischer (1989) remarks some techniques for the noise problems of open offices. These actions include pumping in white noise (low-level unstructured noise from across the audible sound spectrum) or piped music, or the use of noise dampening materials, can be used to mask intermittent office noise (e.g., human speech or telephones ringing).

SC.13.6. Using higher panels to separate teamwork zones: Zhang, Kang, and Jiao (2012) proposed using higher panels to separate work space or working in enclosed offices as an efficient improvement measure. However, in partitioned spaces the possibility of hearing others or to be heard by them still remains as unsolved problem in open-plan offices (Yildirim, et al., 2007). Since the lower partitions minimize the acoustical privacy between work stations, workstations, in this situation, can be

grouped according to the job sensitivity and reserve inner spaces with higher partitions for more noise sensitive tasks (Reinhart, 2002).

SC.13.7. Using movable and divider partitions: using moveable partitions to solve the problem of noise has been recommended by Vischer (1989). The minimum height for partitions and screens with the aim of acoustic privacy is proposed 60 inches (1.52 m). Using divider panels between the work stations is also recommended by Passero, & Zannin (2012). In spite of all these studies on applying panels and screens to avoid noise problem.

SC.13.8. Adding free-standing sound absorbent partitions: screens help interrupt the sound waves and reduce noise distraction.



**Figure B.3.** Free standing acoustical partitions (Schittich, 2011, p.42).

#### **SC.14. Reducing visual obstructions around the workstations**

Daylight in the interior spaces is more critical issue than the peripheral zones, for this reason, in central interior spaces, internal design variables are more influential in terms of energy savings (Reinhart, 2002). One effective action is lowering the screens' height, which discussed in Section SC.12.1.



## **SC.15. Increasing daylight**

SC.15.1. Using high-reflectance partitions: using partitions with high reflectance surfaces will help to increase the amount of daylight at 2nd row offices (Reinhart, 2002).

SC.15.2. Using high-reflectance ceiling surfaces: high reflectance surface leads to a more uniform distribution of daylight throughout the space and have positive effect on energy savings. This option as a lowest design measure is highly recommended. Using flat screens instead of conventional monitors, will disappear the unwanted reflective glare of the glossy ceilings (Reinhart, 2002).

SC.15.3. Using artificial lighting systems: partitions and screens have a considerable impact on overall lighting efficiency, even, low-level partitioned zones in an office plan causes complicated lighting design problem. The most significant point in artificial lighting is the true choice of the light source and its layout. In the case of partitioned open-plan spaces, the illumination degree is generally diminished due to the created shadow effects by vertical obstructions. However, the reduced quality of lighting because of the shadow effect can be controlled firstly, by increasing the number of lighting lamps and secondly, installing luminaries in a more dense adjustment on the ceiling of partitioned space (Kim, 1999).

SC.15.4. Applying dynamic artificial lighting systems: light lamps can be programmed and adjusted to be in warm and cool colors, therefore can create a variety light intensity and tones, called “Dynamic Lighting”. Indeed, the artificial light mimics the dynamics of natural daylight. For instance, warmer and less bright in the morning and at the end of the day, brighter and cooler during the day.

SC.15.5. Integrating daylight with artificial lighting: the aim of daylight planning for offices should be to admit diffuse light as much as possible while blocking the direct sunlight. This can be done with the appropriate solar protection. In spaces with low accessibility to daylight, before applying the artificial lighting, the light deflection

methods should be assessed, as discussed in details in first framework daylighting systems (Schittich, 2011, p.50).

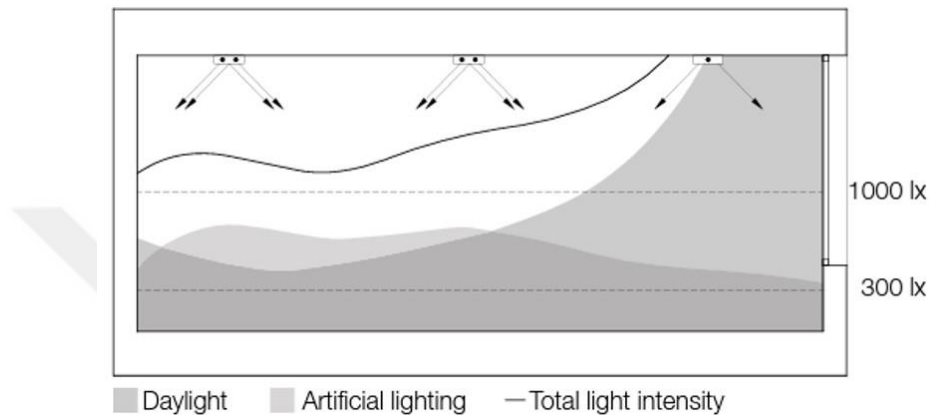

**Figure B.4.** Cross-section of a combined lighting scenario (Schittich, 2011, p.50).

SC.15.6. Using warm colors in north-faced rooms: as regards the fact that north facing rooms receive minimum daylight and sun radiation through the day, it is proposed to use warmer colours in these spaces (Duffy, et.al., 1988, p.145).

### **SC.16. Increasing the degree of enclosure**

This alternative is proposed by scholars as the solution to visual privacy distractions. A research by O'Neill and Carayon (1993) revealed a positive relationship between the physical proportions of enclosure (number and height of partitions) and privacy satisfaction. Results of study by Kim, & de Dear (2013) on visual privacy also advocated a considerable growth in satisfaction level on the visual privacy of open plan offices as the degree of enclosure increased from no partition, to low partition, and to high partition. Generally, privacy and satisfaction domains seem to be solvable by increasing the height of the workstation enclosure.

SC.16.1. Providing more partitions with optimum height: Daroff and Rappoport (1992) proposed 1.27–1.32 m high partitions when seated, (1.67–1.77 m) while standing as minimum desirable height for achieving visual privacy. Invariably, workers in spaces enclosed by high partitions claimed greater levels of perceived privacy (Maher and von Hippel, 2005).

### **SC.17. Incorporating color in workstations**

SC.17.1. Incorporating color in workstations: Adding color to the interior spaces of offices, especially in offices with flexible work environment, will add personality to users' work zones (Schittich, 2011, p.42).

SC.17.2. Adding different colors to different workstations: In multi-functional and mobile work places, adding colors to various types of workstations will work as a sign for both workers and clients to get their way (Schittich, 2011, p.42).



**Figure B.5.** Decorating workstations with color (Schittich, 2011, p.42).

## APPENDIX C

### DETAILS OF PASSIVE ACTIONS IN FAÇADE RETROFIT FRAMEWORK

#### TC.1. Reducing heat transfer (using high thermal resistant cladding materials)

TC.1.1. Using non-structural masonry cladding materials: For buildings that require the look of traditional full brick masonry, lightweight, and low maintenance brick veneer claddings can be used.

TC.1.1.1. Brick veneer façades: A single exterior layer of nonstructural brick masonry can be supported by cold-formed steel framing or by a concrete masonry unit. Whether clay or concrete based, the thickness varies in size. As seen in Figure C.1, there is an air space or cavity between the outer brick layer and inner support system, which allows the façade to drain the penetrated water. To improve the thermal behavior of the façade, it is also recommended to use rigid insulation layer within the cavity part or batt insulation for the steel framings. Overall R-values for such assemblies (all materials within wall) ranges between 14.60 and 23.54 (m<sup>2</sup>-K/W) (Aksamija 2013).

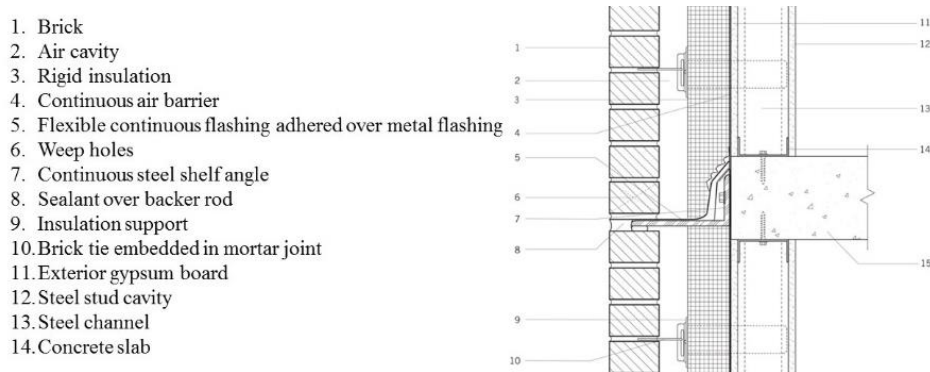

**Figure C.1.** Application of brick cavity wall with steel stud framing (Asamija, 2013, p. 24).

TC.1.2. Using metal-based cladding materials: like Color-coated steel and aluminum, Rheinzink, copper, brass and bronze, pattern-painted aluminum

## **TC.2. Reducing heat transfer by using thermally insulated panels**

TC.2.1. Using insulation integrated opaque panels: There are different types of composites such as concrete in the construction or the most common Fiber reinforced polymers (FRP) composed of polymer resins and all kind of fibers.

TC.2.1.1. Fiber reinforced polymers cladding panels (FRPs): FRPs have low thermal transmissibility (as low as that of wood) and are also lightweight and customized shape. The low thermal conductivity of all polymers makes FRPs good heat insulators and very resistant against moisture. These panels are inert materials to corrosion and have very low electrical conductivity, which makes them good choice to be used for insulation (Berardi and Dembsey, 2015).

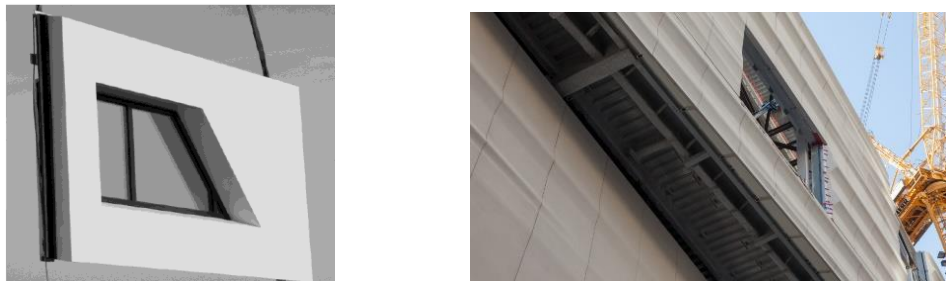
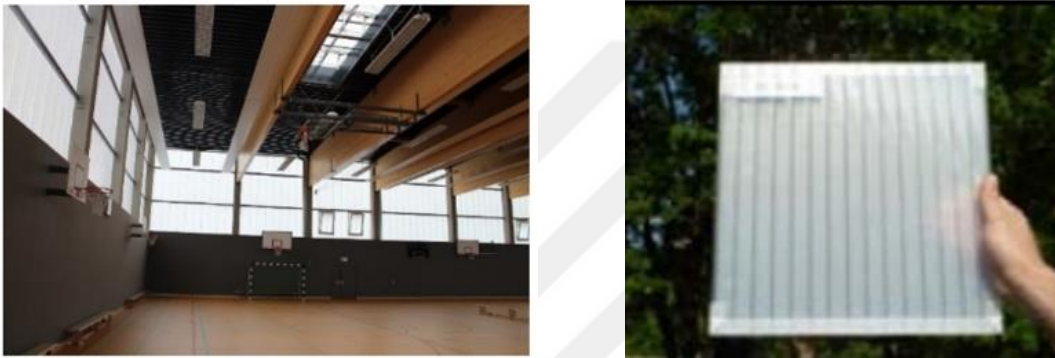

**Figure C.2.** Left: FRP sandwich panel (Rietbroek, 2013), right: a unitized FRP panel (KREYSLER).

TC.2.2. Using panels with translucent insulation materials (TIMs): Integrating TIMs within façade panels allows the transmission of diffuse light and the resistance of heat.

TC.2.2.1. Aerogel-filled multi wall polycarbonate panels: Aerogel's performance is known as a thermal (conductive and convective heat transfers) insulator, acoustical

insulator, light transmitter and energy-free solar collector. The thickness ranges between 10 to 50 mm. can be used in sandwich panels. The air is the major component (95%) of its composition and the other component is silica, which makes aerogel the world's lightest solid material. This material is commercially available in the forms of monolithic and granular (Trubiano, 2013).



**Figure C.3.** Example of granular aerogel filled PC panels (Moretti, et al., 2017).

TC.2.2.2. Vacuum-insulated panels (VIPs) or Phase-change materials (PCMs): As a lightweight insulation material with a thermal conductivity of 0.005 (W/m.k) keeps the façade thermal conductivity at a very low rates. However, the problem of thermal bridging need to be taken into account and between two adjacent panels (in the joint point) or around the frame there should not be air gaps (Capozzoli, et al., 2015). These panels have up to 1/7 the thermal conductivity of standard insulation materials. Because of their very thin thickness, applying VIPs on exterior walls decreases the thickness of wall while giving an improved thermal behavior to the wall (Aksamija, 2013, p.71). Durability and the performance of VIPs can decrease due to vacuum loss over time or by mechanical damages.



**Figure C.4.** VIP Samples: (a) VIP 10 and 30 mm thick; (b) punctured VIP and VIP core material; (c) Extruded polystyrene (XPS) (Lorenzati, et al., 2017).

Phase-change materials (PCMs) can be transformed from solid to liquid depending on the space temperature. At lower temperature they have a solid form, however, in higher temperature by absorbing and storing heat they become a liquid material. The process is absorbing heat during the peak hours of the day and dissipating the stored heat during cold hours of the night.

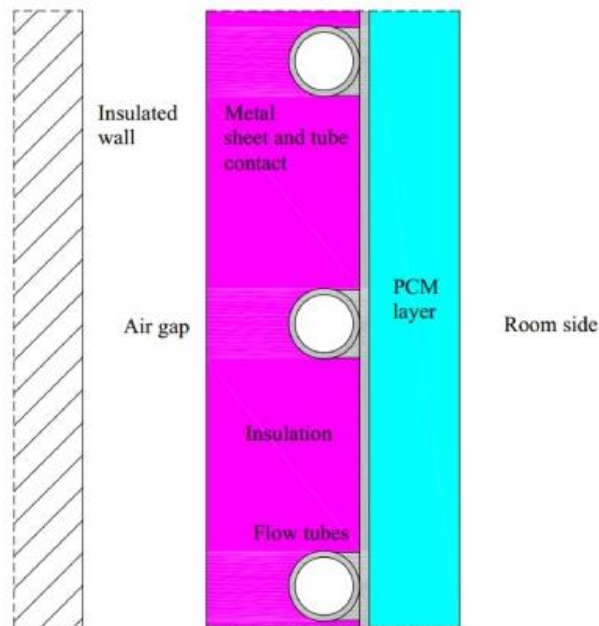

**Figure C.5.** The PCM panel conceptual scheme (Bigaila and Athienitis, 2017).

TC.2.3. Using insulating concrete units: Precast concrete panels in two types of “cast-in place” and “insulated tilt-up concrete panels” are mostly used types of cladding materials with secondary support.

TC.2.3.1. Thin-shell precast concrete panels: these panels consist of 50 mm concrete cast onto cold-formed steel framing. The panels are low weight compared to standard per-cast panels. In order to improve its thermal behavior, foam insulation is sprayed within the panel (Aksamija, 2013, p.23).

TC.2.3.2. Insulating concrete forms (ICFs) or block (ICBs): these types of concrete façades include insulating concrete forms that are comprised of extruded or expanded polystyrene panels that perform as the formwork for cast-in-place concrete units. The polystyrene panels are covered with a finish coating inside and outside. These types are suitable for small scale commercial buildings. Insulating concrete block (ICBs) are masonry concrete units that include an expanded polystyrene sandwiched between two faces of each block.



**Figure C.6.** Installation of the pre-cast concrete panels (Aksamija, 2013, p.23).

The most significant problem related to the insulation units and panel is the thermal bridging. When a highly conductive material like metal membrane penetrates into the



insulation layer of wall in façade, thermal bridging occurs, which negatively affects thermal behavior of the assembly.

### **TC.3. Reducing conductive & convective heat transfer through the glass panes**

TC.3.1. Using multi-pane glazing: existence of a motionless air layer between the two glass panes in a double-glazed window increases the thermal resistance and consequently reduces the heat transfer coefficient (u-value) of the window. However, the thickness of this gap should not exceed beyond the optimal gap size. If the gap is large, there will be enough space for convective motions, which will lead to increase the heat loss through the glass (Harvey, 2012).

TC.3.1.1. Double-, triple-, or quadruple-glazed windows: windows with second, third or fourth panes between the inner and outer panes are called respectively, double-, triple-, and quadruple-glazed windows. However, the increased weight and thickness might be a problem. Instead of using triple or quadruple glazing, inserting one or two thin polyester coated low-e films between the inner and outer panes can be a good alternative (Harvey, 2012, p.63).

TC. 3.2. Using gas-filled windows with low thermal conductivity: using heavy molecular weight gases like argon, krypton, and xenon instead of air can give a better thermal behavior to window. Argon-filled windows are available in many countries, however, krypton and xenon-filled ones respectively are available in US and Germany (Harvey, 2012, p.63).

TC. 3.3. Using insulated glazing units (IGSs): IGSs consist of four layers of glass and three insulating gaps. The inside gap is filled by a phase-change material (PCMs) and the outer gaps are filled with inert gas. The outermost gap includes a prismatic pane, which makes the glazing unit to perform as passive heat sources. During winter, the prismatic pane absorbs the low-angle sunlight and liquefies the PCM and transfers the heat to the inside of the building. In summer days, the prismatic pane reflects the high-angle sunlight and prevents the heat gains. Although these units are translucent and

allow the penetrating the diffuse daylight, their visual transmittance does not exceed 45%, which make them inappropriate for rooms requiring views (Aksamija, 2013).

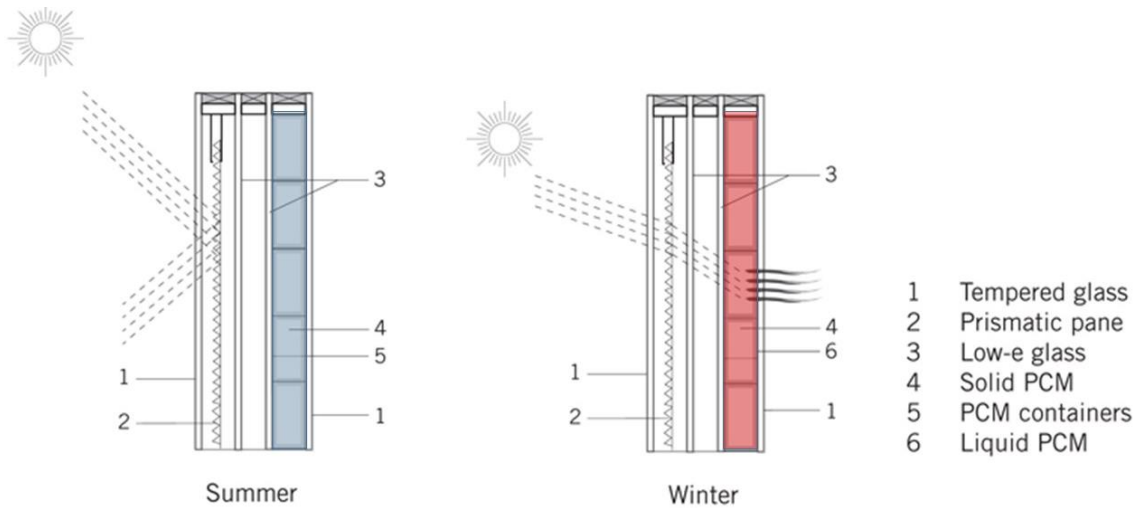

**Figure C.7.** Triple-insulated glazing unit with PCM (Aksamija, 2013, p. 74).

TC.3.3.1. Vacuum-insulated windows and hard low-e coatings: Compared to standard air- or gas- filled insulated glazing units, vacuum-insulated glazing gives a higher thermal resistance to the window. In these product, a vacuum is applied between two glass panes. As there is no air or gas between glass lits, the possibility of conductive or convective heat transfer is near zero. Since, these units are very thin they account good alternatives for retrofit projects that require the installation of a high-performance window in existing frames (Aksamija, 2013, p.71).

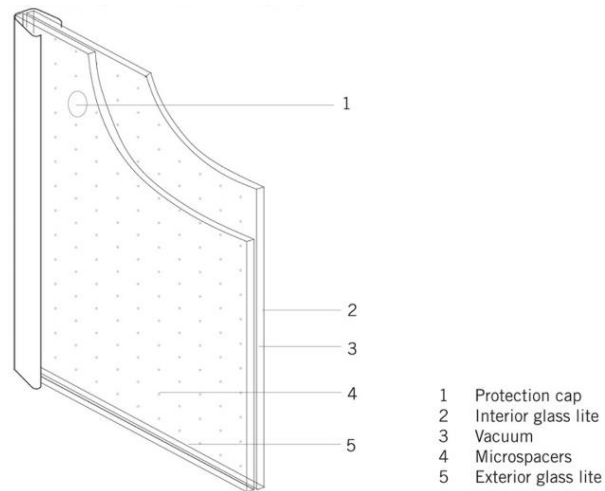

**Figure C.8.** Vacuum insulated glazing unit, schematic diagram (Asamija, 2013, p.71).

TC.3.4. Using transparent insulation for inclined windows and skylights: as regards the fact that inclined windows and skylights have usually higher convective heat transfers between glass panes compared to the vertical windows, their U-value is also greater than that of vertical ones. (Harvey, 2012).

TC.3.4.1. Silica aerogel layers: The extremely low thermal conductivity of silica aerogel insulation layers is due to their low density. As described in TC.2.2.1, by integrating them with polycarbonate sheets they can also be used as translucent cladding materials (Aksamija, 2013, p.70). Figure C.10 shows a monolithic silica aerogel developed by Jensen et al. (2004) due to its low-iron glass type and with an anti-reflective coating is more transparent than the former type.

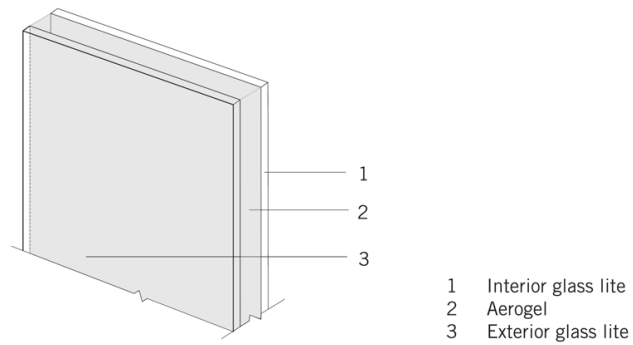

**Figure C.9.** Schematic diagram of silica aerogel insulated glazing (Aksamija, 2013, p.71).



**Figure C.10.** Monolithic aerogel glazed window (Berardi, 2015).

#### **TC.4. Reducing conductive heat transfer through the frame**

TC.4.1. Using insulated framing materials and spacers: the greater part of heat losses through even a high-performance window occurs through its frame. For this reason, the average U-value for the window system in some cases is more than twice the U-value of the center of glass. To prevent this, frames should be thermally broken and as said before, should continue into the insulation layer of wall (Harvey, 2012).

TC.4.1.1. Thermally broken aluminum frames: adding a silicon layer between the outside glass and aluminum frame. Silicone plays the role of a thermal break, which lasts for 40 years (ASHRAE, 2001b, chapter 30).

TC.4.1.2. Coated aluminum cladding frames: to protect aluminum cladding profiles against humidity and high temperatures, they need to be powder coated or anodized. This action also lasts for 40 years (Harvey, 2012, p.66).

TC.4.1.3. Incorporating the frame into the insulated wall: one of the main reasons of heat losses through the frame, despite the existence of insulation, is because of the discontinuous frames in reaching the external wall insulation. In some cases, the mean U-value for such windows is more than twice the center of glass. To avoid this problem, the window frame should incorporate to the wall and overlap the insulation (Harvey, 2012, p.67).

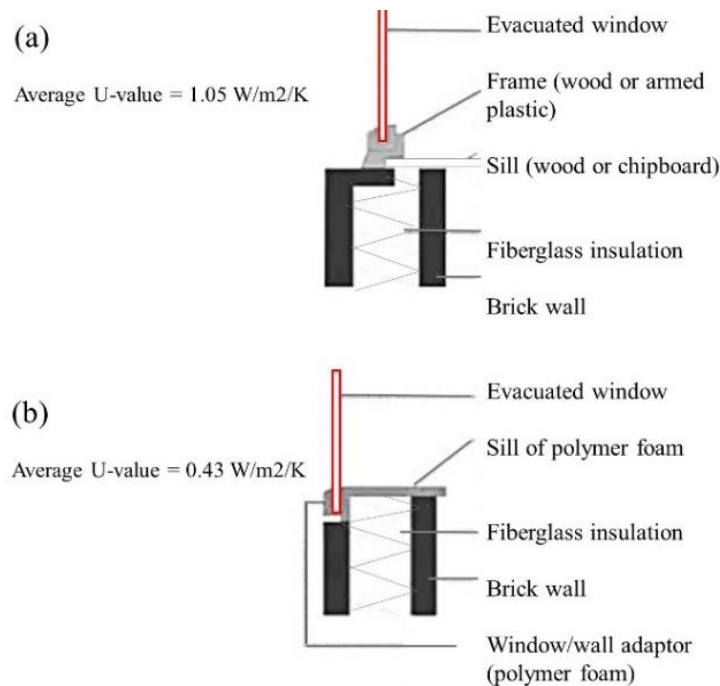

**Figure C.11.** Difference between the average U-values of a standard discontinuous frame (a) and a frame overlapping the wall (b) (Bredsdorff et al., 1998).

TC.4.1.4. Silica aerogel spacers: thermal conductivity of silica aerogel frames are four to five times less than that of the best framing material currently used (Harvey, 2012).

TC.4.2. Using composite frames (for maximum insulating): As regards the high thermal conductivity of aluminum frames, they need to be combined with other low thermal conductive materials, like wood or they should be coated (Harvey, 2012).

TC.4.2.1. Aluminum-clad wood frames: this option has the strength and durability of a low maintenance, exterior aluminum frame with the warmth of naturally insulating wood on the interior and lasts more than 40 years. Aluminum cladding is more conductive than vinyl cladding, which makes it less energy-efficient. Roll-form aluminum is thinner, flimsier and usually priced less.

TC.4.2.2. vinyl frames / vinyl-clad wood frames: Although is not as solid (rigid) as aluminum, but has a lower thermal conductivity compared to aluminum.

## **TC.5. Reducing heat loss from window to outside**

TC.5.1. Using low-emissivity coatings: coating the glazing with a special film that reduces the window emissivity and therefore reduces its heat losses. The surface will have -absorptivity and if placed on the inner side of the inner glazing, help to keep heat inside the room (Harvey, 2012). Low-e coatings are categorized as soft or hard films (Hollands et al., 2001).

TC.5.1.1. Soft and hard low-e films: 6-9 thin layers each with 6-12 nm thickness form the soft low-e film structure. They have low emissivity and also low solar transmittance. Their metal or metal/dielectric combinations give them an extremely fragile state. Hard low-e films consist of a hard and durable layer with the thickness of 100-400 nm, which is applicable to glass in several meters wide. With an emissivity of 0.2, their solar transmittance is almost up to 78%. Both types can be produced to have low NIR (near infrared radiation), low solar transmittance and high visual transmittance rates (Harvey, 2012, p.65; Hollands et al., 2001).

TC.5.2. Applying low-e coatings to the inner surface of the inner glazing: in double-glazed windows, to increase the effectiveness of the single low-e coating, it is recommended to apply it on either of the surfaces facing the inner gap.

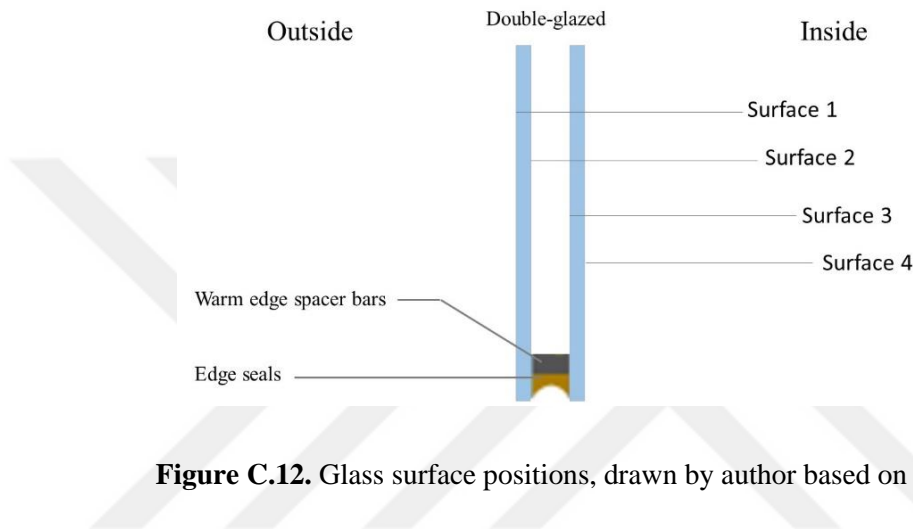

**Figure C.12.** Glass surface positions, drawn by author based on literature.

TC.5.2.1. Adding a coating on surfaces #2 (in summer) and #3 (in winter): in double-glazed windows adding a low-e coating on surface 2 and 3 (inner facing surfaces) is more effective than the low-e coating on surface 1 or 4. The addition of low-e coating facing the air space, reduces the U-value. To reduce heat loss in winter low-e coating should be applied on surface #3, which helps to slow heat transfer from the inside of room to outside. Surface 4 has about 3/4 of the impact of adding a coating on surface 3 (Harvey, 2012; Aksamija, 2013).

TC.5.2.2. Adding a low-e coating only on one surface of the inner glazing in triple-glazed windows: In triple-glazed windows, in order to avoid the trapping of absorbed solar radiation within the window, the low-e coating must be applied only on one surface of the inner glazing. Otherwise it will result overheating problem (Harvey, 2012).

TC.5.3. Using interior storm window coverings: storm panels are applicable on single-glazed windows to reduce winter heat loss as much as 50%. They can be either interior panels or exterior ones.

TC.5.3.1. Adding interior storm panels on windows: they can either flexible (i.e. polyethylene) or rigid plastic panels. Rigid ones are applicable using magnetic or snap-in seals. Flexible ones also can be easily applied in window frame using snap-in retainer seals, however, flexible panels may also sag after installation. They are more useful for windows with awnings.



**Figure C.13.** Storm window panels; left: clear acrylic plastic sheet; right: flexible inside storm panel. (<http://www.builditsolar.com> and <http://green-conscience.com>, respectively).

TC.5.3.2. Using mid-pane blinds: These blinds are ideal options for further solar gains in winter because they keep the space warmer in winter. They can provide up to 35% more solar heat gains than fitting conventional interior venetian blinds.

TC. 5.4. Using exterior storm window coverings: for exterior storm panels also there are two types; single or combination. They should be installed in the fall and take down in the spring. Single panels are usually glass, rigid plastic, or plastic sheeting. Combination panels are made of two window panes with a permanent screen on the window, which can be slide up in summer for ventilation.

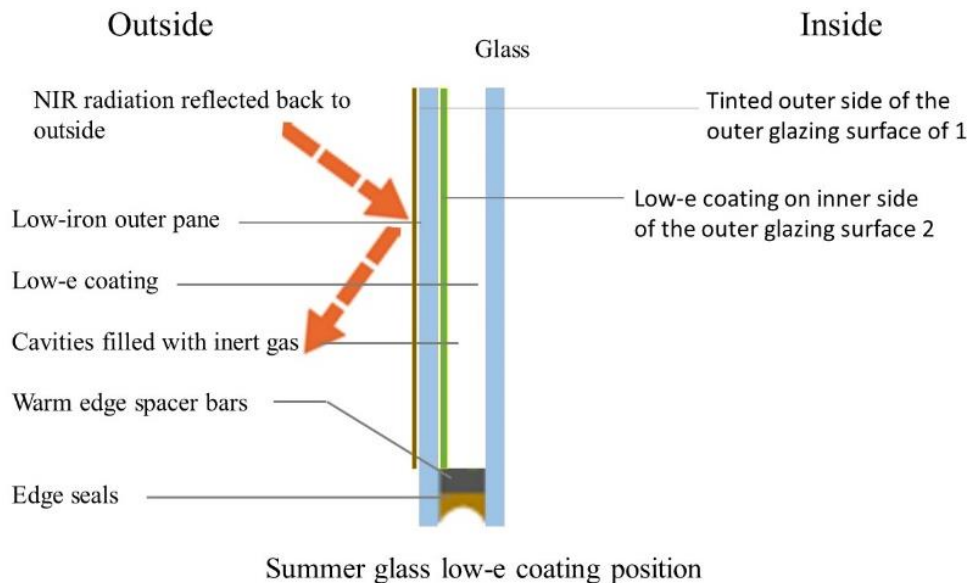



**Figure C.14.** Exterior storm panel (<http://www.petrkola.org>).

## TC.6. Reducing summer heat gains through windows

TC.6.1. Applying low-e coatings on the outer glazing of double- or triple-glazed windows: In order to avoid summer overheating, low-e coatings should be applied on the outer glazing (Harvey, 2012, p.76).



**Figure C.15.** Low heat gains in double-glazed windows with low-e coating on surface2 and a tinted surface1 (by the author based on literature).

TC.6.1.1. Applying low-e coating on the surface #2 (in summer): as mentioned, to reduce solar heat gains in summer low-e coatings should be applied on the innermost surface (#2) of the outer glazing to partially reflection of solar rays and minimum heat absorption within window. In some cases it may recommended to apply a tint on outermost of the outer glazing. For these case, the SHGC will be as low as 0.29 (Harvey, 2012, p.76).

TC.6.1.2. Using flappable windows with low-e coating: in the case of windows, which have the capability of closing in either side facing (rotating), by flipping them over in heating seasons the heat will be trapped and absorbed in innermost glazing surface. Thus, they can act as passive heating sources in winter. For the described window in TC.6.1.1, by flipping the same window, SHGC will be increased that is good for solar heat absorption during winter period (Feuermann & Novoplansky, 1998).

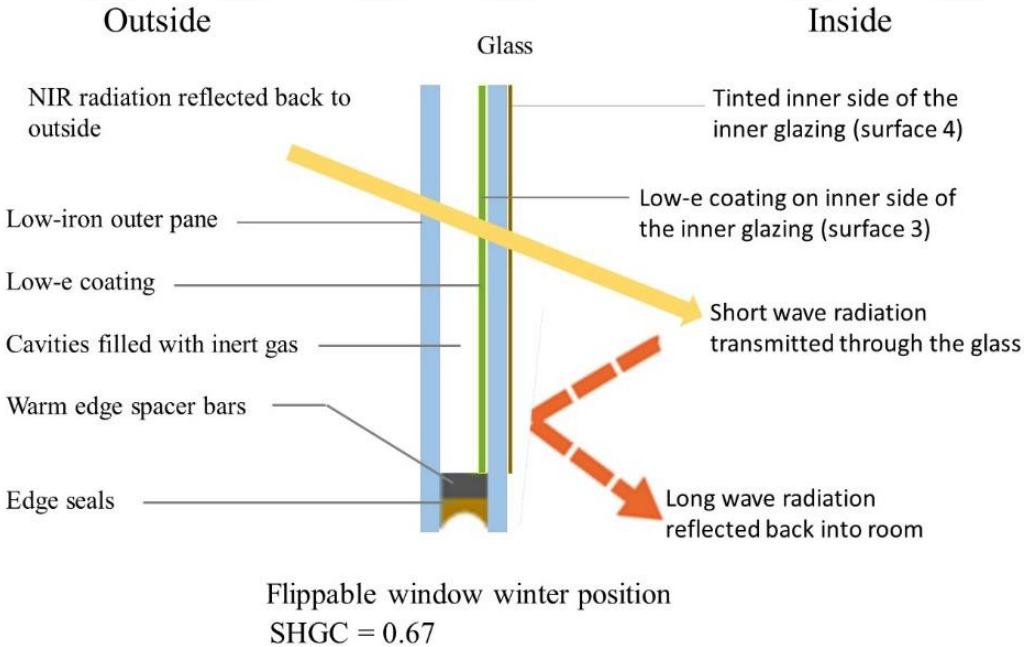

**Figure C.16.** Reducing winter heat loss in a flappable double-glazed windows (by the author based on literature).

TC.6.2. Using reflective glazing on east and west facades: reflective films help to block summer heat gains, since they diminish the overall solar heat gain coefficient of the window, they will not appropriate options during winter. Thus, they should be used for mixed climates, which have long cooling season.

TC.6.2.1. Silver mirror-like films (transparent): silver, mirror-like films are effective than the colored ones. As the great heat gains occur on east and west facing facades, if these films are selected to be applied on existing windows, they should be applied on east and west façades.

TC.6.2.2. Spectrally selective low-e coated glazing units: spectrally selective coatings are a special type of low-e coatings that by filtering out 40% to 70% of heat transmission through the insulated glazing unit, do not block the daylight (VT). They are engineered to reflect a certain domain of wavelengths (NIR) but passes others (visible light) into room. Spectrally selective coatings can reduce electric cooling loads.

TC.6.3. Provide self-shade through building skin: exterior shading can be provided by the extension of the skin itself. If shading attachments are not aesthetically acceptable, the building form can be used for shading itself. For this purpose, the window should be placed back in a deeper wall section. However, this might not be a possible solution for retrofit.

TC.6.4. Using exterior shading devices: the fixed types of external shading devices are not recommended in literature, since the fixed external louvers cannot provide sufficient shade for all seasons and periods of the year and also they block a considerable proportion of the view from inside to outside. Furthermore, the motorized types are more appropriate for majority of the retrofit projects (Stevens, 1998). However, the movable and motorized options are require high budget in terms of both product cost and maintenance costs.

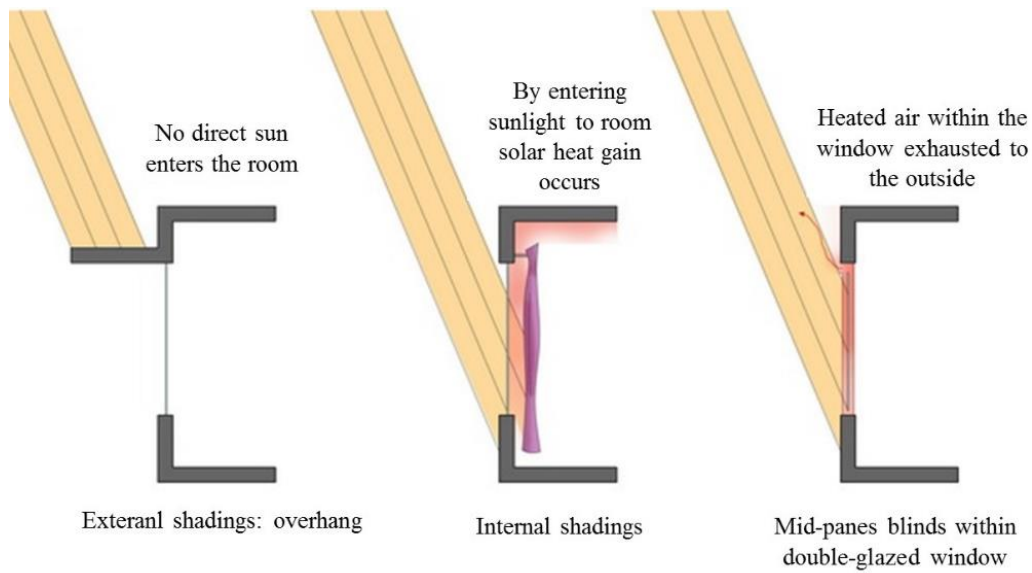

**Figure C.17.** Different shading locations and their effects on reducing solar heat gains (by the author based on literature).

TC.6.4.1. Using mesh window screens: these external screens need to be applied on an exterior frame on east and west facing façades while, covering whole the window. They diffuse solar radiation and eliminate summer solar heat gains.

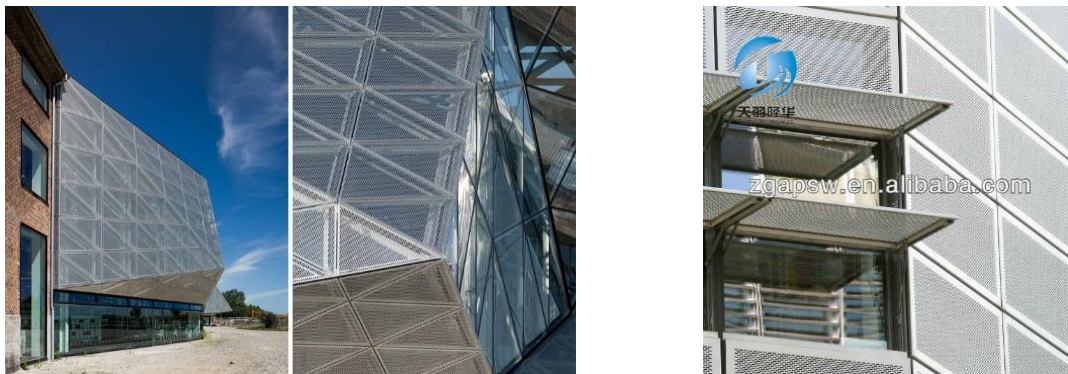

**Figure C.18.** Left: an entry façade of *The Culture Yard Building*, screened with steel mesh ([www.designboom.com](http://www.designboom.com)); right: operable aluminum mesh screen ([dutch.alibaba.com](http://dutch.alibaba.com)).

TC. 6.4.2. Horizontal and adjustable shading devices on south façade: the shading strategies for south and west windows need to be given priority. For south facing façades, fixed horizontal devices should be used such as, awnings and overhangs. Overhangs should be oriented properly to allow solar penetration during winter days. Awnings are other options to reduce solar heat gains by more than 65% on south façade and up to 77% on west façade. However, to avoid the trapping of heat around awnings, there should be opening along top or sides of an awning to provide air flow.

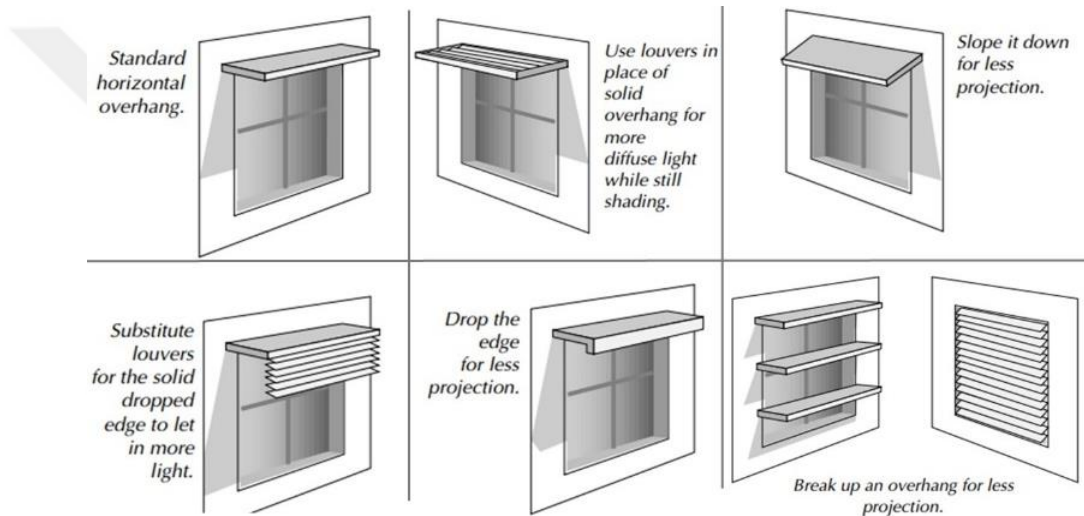

**Figure C.19.** Positions for horizontal shadings on south façades (US. Department of Energy).

TC.6.4.3. Vertical and adjustable shading devices on west, east, and north facing façades: vertical fins are useful in blocking early morning and late afternoon sun rays (Dubois, 1997).



**Figure C.20.** Vertical shading device (US. Department of Energy).

TC.6.4.4. Exterior fixed egg-crate shading boxes (combined horizontal & vertical shading): this device is designed to respond to all the solar angles and is suitable for west and east facing facades. Despite the effectiveness of egg-crate shadings, they block too much daylight and outside view, especially in winter prevents the daylight and solar heat penetration to the inside space (Dubois, 1997).

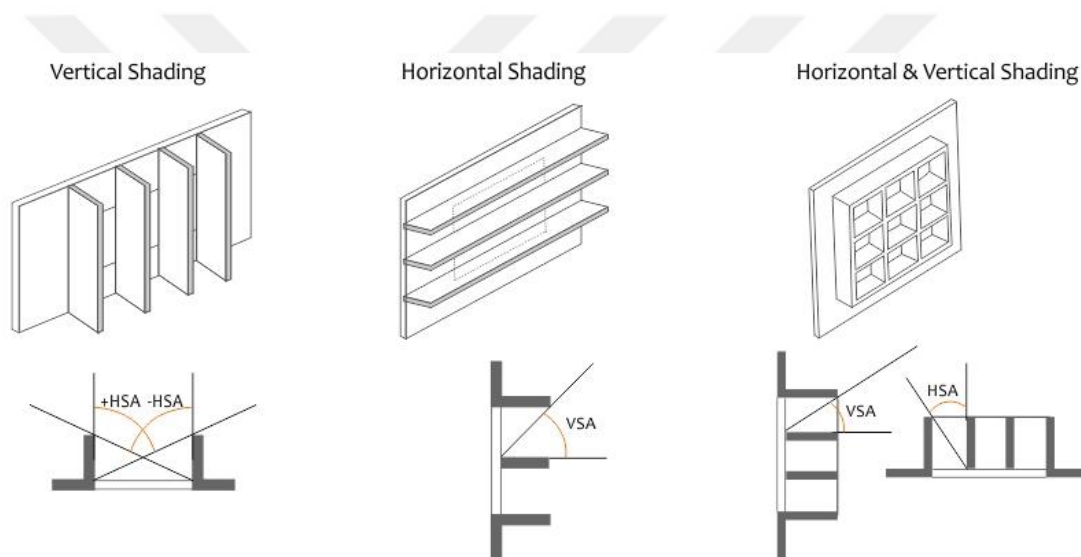

**Figure C.21.** Three main shading strategies (<http://www.nzeb.in>).

TC.6.4.5. Using fritted glass louvers: while providing the sufficient shading and excluding solar heat gain, but still invites some of the daylight into the inside space (Stevens, 1998). Fritted glass louvers are great options to provide shading for a large glass areas on south, west, or east façades. Commercially available louvers have typically translucent ceramic coating on their undersides that screens direct sun rays. They can automatically adjusted by the BMS to rotate based on the sunlight angles (Vassigh & Chandler, 2012).

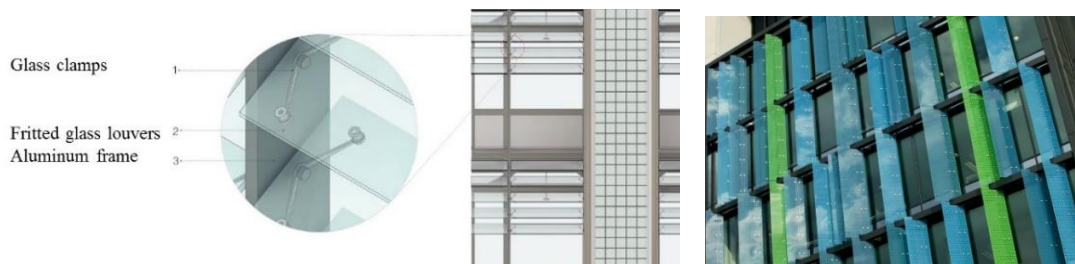

**Figure C.22.** Left: Horizontal and controllable fritted glass louvers on the south façade; right: Vertical laminated glass louvers of Severn Trent Centre (Vassigh and Chandler, 2012).

TC.6.4.6. Adding roller shutters on external side of the existing windows: Roller shutters provide a good protection for existing windows in terms of severe weather conditions, solar heat gains and also security and privacy. Besides their summer function, insulated or laminated with metalized Mylar material versions can be used also during winter and can substantially reduce heat loss during heating seasons.

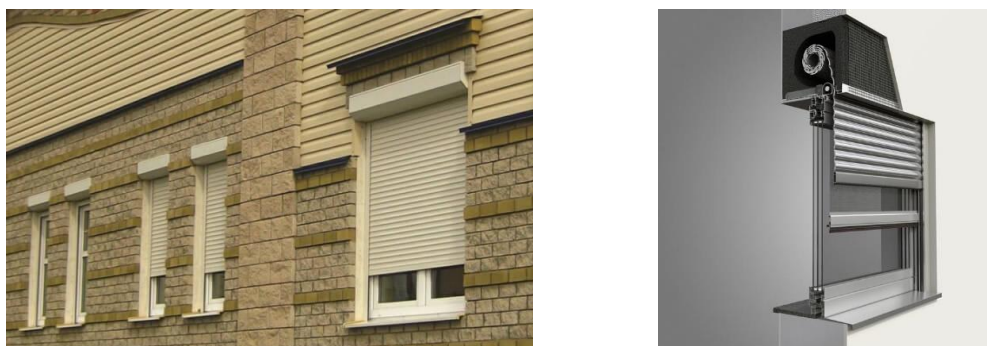

**Figure C.23.** External roller shutters ([www.rsgsecurity.co.uk](http://www.rsgsecurity.co.uk)).

TC. 6.5. Using light colored and open weave fabric interior shading devices: internal blinds are not as effective as the mid-pane blinds and external blinds since the solar heat will be already in the room. Mid-pane blinds are more effective if the retractable type of them get choose and do not interrupt the view too much (Stevens, 1998).

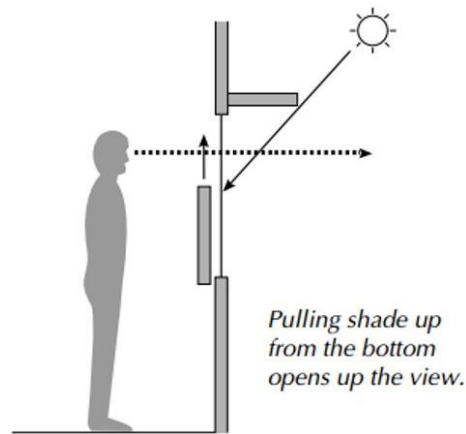

**Figure C.24.** Schematic function of interior blinds that filter but do not block daylight (windows.lbl.gov).

Based on the technical framework prepared by the European norm EN 14501 two main function indicators of screens are direct and diffuse transmittance of screen fabrics, which indicate their ability to control glare. Direct refers to light that passes through the blind unaltered. Diffuse refers to light that is scattered in all directions by the yarns of the fabric (Figure C.25). According to EN 14501, the optimal transparency relates to the fabrics with more than 10% openness and with a diffuse transmittance of less than 4%. These are fabrics consisting of dark yarns.

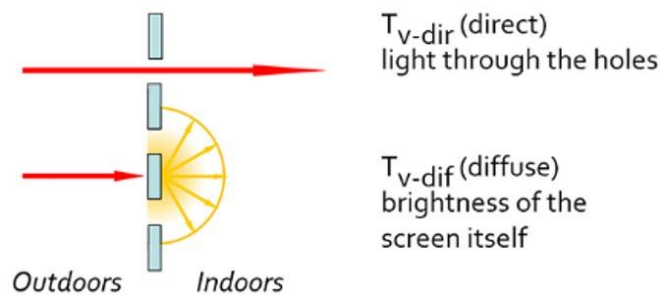

**FigureC.25.**Two function indicators of interior screens (www.hunterdouglasarchitectural.eu).



TC. 6.5.1. Venetian blinds and louvered blinds: For occupant comfort, either a light-colored venetian blind or light-colored translucent shade on all windows in occupied areas should be provided. For energy savings, these are desirable to include even with exterior shading; they are mandatory if there is no exterior shading.

**TC.6.5.3. Roller blinds:** these blinds are available in two types of full block out or light filtering fabrics. The former versions are used to full block out to darken room for full privacy, and the latter type are ideal to soften vision in and out.

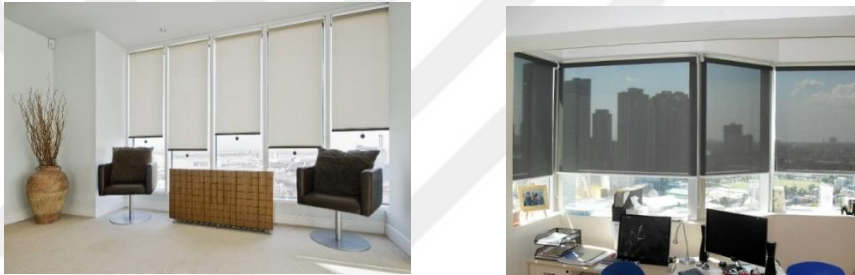

**Figure C.26.** Interior roller blinds (<http://www.texstyle.com.au>).

TC.6.5.4. Adjustable Cellular shades: The commercially available vertical cellular shades have honeycomb-shaped cells to trap air and help insulate the inside. In fact, these sunshades can slash summer heat gain by up to 56% and reduce winter heat loss by up to 22% (energy.gov; baliblinds.com).

TC.6.5.5.Using mid-pane blinds: are also known as double-glazed blinds. As mentioned previously in section TC.5.3.2, they have the double benefit of retaining more heat in the winter and also reflecting heat during the summer. They can be controlled by specialized magnetic controls or in some cases by electronically controlled systems.

## **TC.7. Reducing summer heat gains (SHGC) through windows**

TC.7.1. Using glazing systems with high visible transmittance and low NIR transmittance: when there is a need to minimize heat gains (solar transmittance) while allowing to have sufficient daylight during summer and conversely, to maximize solar transmittance during winter. Switchable low-e glass coating and using high-iron glass types are two ideal options described below (Harvey, 2012, p.73-76).

TC.7.1.1. Using switchable low-e glass coatings: these low-e coatings have capability to switch from high reflectivity/ low transmission (absorption) to low reflectivity / high transmission near the visible infrared boundary (NIR). Energy savings of switching systems is considerable in climates with consistent daylight illumination conditions, either sunny or cloudy all day long.

TC.7.1.2. Using high-iron glasses: the heat absorbent of every glass type relates to the iron amount in its structure. Glasses with high level of iron tend to have lower solar transmittance (low SHGC) and while, having adequate visible transmittance (Rosencrantz et al, 2005). In the cases, which require to have a high solar transmittance with maximum visible transmittance (zero reflectivity), adding an anti-reflective (hard films) low-e coating can cut the reflection by half (Harvey, 2012, p.76).

TC.7.2. Synchronizing the solar transmission with sunlight angle: adding various combinations of thin films to glass to increase solar transmittance for low-angle incidences (in winter) and to reduce solar transmittance for high-angle incidences (in summer)

TC.7.2.1. Using angular-selective thin films: using a thin film system of two 12nm films of silver embedded between three films of 120nm SiO<sub>2</sub> (SiO<sub>2</sub>/Ag/SiO<sub>2</sub>/Ag/SiO<sub>2</sub>). In some cases, low solar transmissivity might be required at low-angle incidences (for east or west facades) or high solar transmissivity might be desired also at high-angle incidences. These films can be engineered to have various

properties at the same angle. For example by choosing the SiO<sub>2</sub> thin films with 170nm thickness (Granqvist, 2003).

TC.7.3. Using Insulated glazing systems: with the capability of blocking solar heat radiation while, passing sufficient daylight (high visual transmission).

TC.7.3.1. Electro-chromic glasses: by the aid of electrical voltage, the film of glass can change its opacity (a clear glass can change to a dark tint glass) and can keep tinted mode without extra electricity. Visual transmittance ranges from 60% (clear) to 4% (tinted). Solar heat gain coefficient (SHGC) also can change from 48% (clear) to 9% (tinted) (Aksamija, 2013; US. department of energy).

TC.7.3.2. Spectrally selective double-lite air-insulated low-e glazing: On the one hand, they are ideal options to pass daylight in winter and can be used for minimum outdoor temperature (in winter-mixed climates) of -9 C. On the other hand, they partially reflect summer sunlight and block high rates of solar heat radiation (Aksamija, 2013; US department of energy).

TC.7.3.3. Aerogel-filled or vacuum insulated glazing unit: low density synthetic solids with low thermal conductivity. Since the silica aerogel glazing is a translucent product, it is not a proper option for vision glass (Aksamija, 2013; Dowson et al., 2011). Vacuum-insulated glazing units are thin units with the thickness range of between 1/4 to 1/2 inches with a U-values of less than 0.57 W/m<sup>2</sup>-K. Their high thermal performance makes them an ideal option to be installed in existing frames in a retrofit project. However, their short lifetime is the main disadvantage point (Schultz et al., 2005).

TC.7.4. Using triple insulated glazing systems: providing good insulation while reducing sunlight glare

TC.7.4.1. Triple-lite air-insulated clear glazing: are mostly suitable for mixed climate zones with minimum outdoor temperature (in winter) of -2 C and as their summer

performance, they are suitable for blocking high rates of solar heat radiation of 456 W/m<sup>2</sup> (Aksamija, 2013).

TC.7.4.2. Triple insulated glazing units integrated with PCMs (as a passive heat source): four layers of glass and three insulating gaps are the main components of these units. U-values of the unit in solid state is 0.48 W/m<sup>2</sup>-K, with a visual transmittance (VT) of 0% to 28% and with an SHGC between 0.17 and 0.48. Visual transmittance of the unit in liquid state (heated) is 4% to 45%. With an SHGC between 0.48 and 0.17 (Aksamija, 2013).

**TC.8. Reducing both winter heating loads and summer cooling loads (balancing heating and cooling requirements):** making an optimum tradeoff among three main thermal comfort indicators of U-value, SHGC, and VT factors.

TC.8.1. Using windows with lower U-value and lower SHGC: when both winter heating loads and summer cooling loads are large.

TC.8.1.1. Using spectrally selective low-e coated glazing units: as mentioned in previous sections, spectrally selective low-e coated windows are ideal options for their function in both summer and winter times. Since they pass daylight in winter and can partially reflect summer sunlight and block high rates of solar heat radiation (Aksamija, 2013; US department of energy).

TC.8.1.2. Using silica aerogel layers between window panes in double-glazed windows: transparent insulating layers between window panes that reduce the U-value of window. Its thermal conductivity can be between less than 0.01 to 0.020 W/m<sup>2</sup>/K (Harvey, 2012, p.85).

TC.8.1.3. Using triple-glazed windows with multiple low-e coatings: achieving a U-value less than 1.0 and a substantial reduction in the SHGC percent, especially, when avoiding overheating in summer is important.

TC.8.2. Using windows with lower U-value and larger SHGC in south facade (in heating dominated climates): for cases that their summer cooling loads are small but the winter loads are large.

TC.8.2.1. Using motorized shading devices and roof overhangs for summer time (solar radiation level is low in summer time at south facades): if the selected window unit has a high SHGC factor, to avoid summer overheating, motorized shading devices should be preferred, otherwise, the cooling loads will begin to increase (Harvey, 2012, pp.78-79; Carmody et al., 2004).

TC.8.2.2. Adding low-e coating on surface #3 in a double-glazed window: to have a relatively high SHGC rates, as discussed in previous sections, low-e coatings should be applied on surface 3 instead of applying on surface 2.

TC.8.2.3. Using low-iron glass types: as discussed in previous sections (TC.7.1.2.), lower amount of iron in a glass structure, increases its solar transmissivity rate. Furthermore, if a glass is coated with low-e films, in order to offset the diminished percent of SHGC, a low-iron glass type can be selected to increase its solar heat gain coefficient (Henry and Dubrous, 1998).

TC.8.2.4. Using vacuum windows: the other option to reduce U-value of the window while keeping its solar heat gain coefficient at high levels, is preferring vacuum glazing windows. In this way, it is possible to achieve a U-value less than 1.0 W/m<sup>2</sup>/K, without large reduction in the SHGC (Harvey, 2012, pp.78-79).

## **TC.9. Reducing infiltration of outside air through walls from stack effects, and wind loads**

Air leakage can affect adversely the building's total energy consumption, as it allows unwanted air flows and heat transfers from outside to inside or conversely. The transferred air can also carry out moisture with itself and in the future lead the envelope

to suffer from mold. To prevent the problem some effective recommendations are given in following sections.

TC.9.1. Sealing joints and cracks between window components: air leaks around movable building elements, like doors or operable windows, can be sealed however, in case of stationary components, the caulk is the recommended material to fill the gaps and cracks.

TC.9.1.1. Using magnetic air sealer and latex caulk: there is wide range of weather-stripping types and materials that should be selected regarding the openings sash type and properties. As a very effective air sealer, it can be referred to magnetic weather-stripping, which is almost costly. As the example for caulking, it can be referred to latex or spray foam versions.

TC.9.2. Using rain-screen systems: a rain-screen façade consists of a weatherproof inner layer (cavity) that block the air and moisture penetration. These façades can be penalized with any type of cladding materials like stone, precast concrete, terracotta, metal, or glass. The inner cavity layer is not visible from the outside and will not change the appearance of the existing façade (Aksamija, 2013, p.24).

TC.9.2.1. Pressure-equalized rain-screens (PER): is one of the rain-screen concepts. The air pressure within the inner layer has been equalized to the outside air pressure. Consequently, the air or water are not been pulled into the cavity layer. These systems have the capability of draining rain water to the outside. The other option to create equalization between inner and outer air, is to considering larger openings.

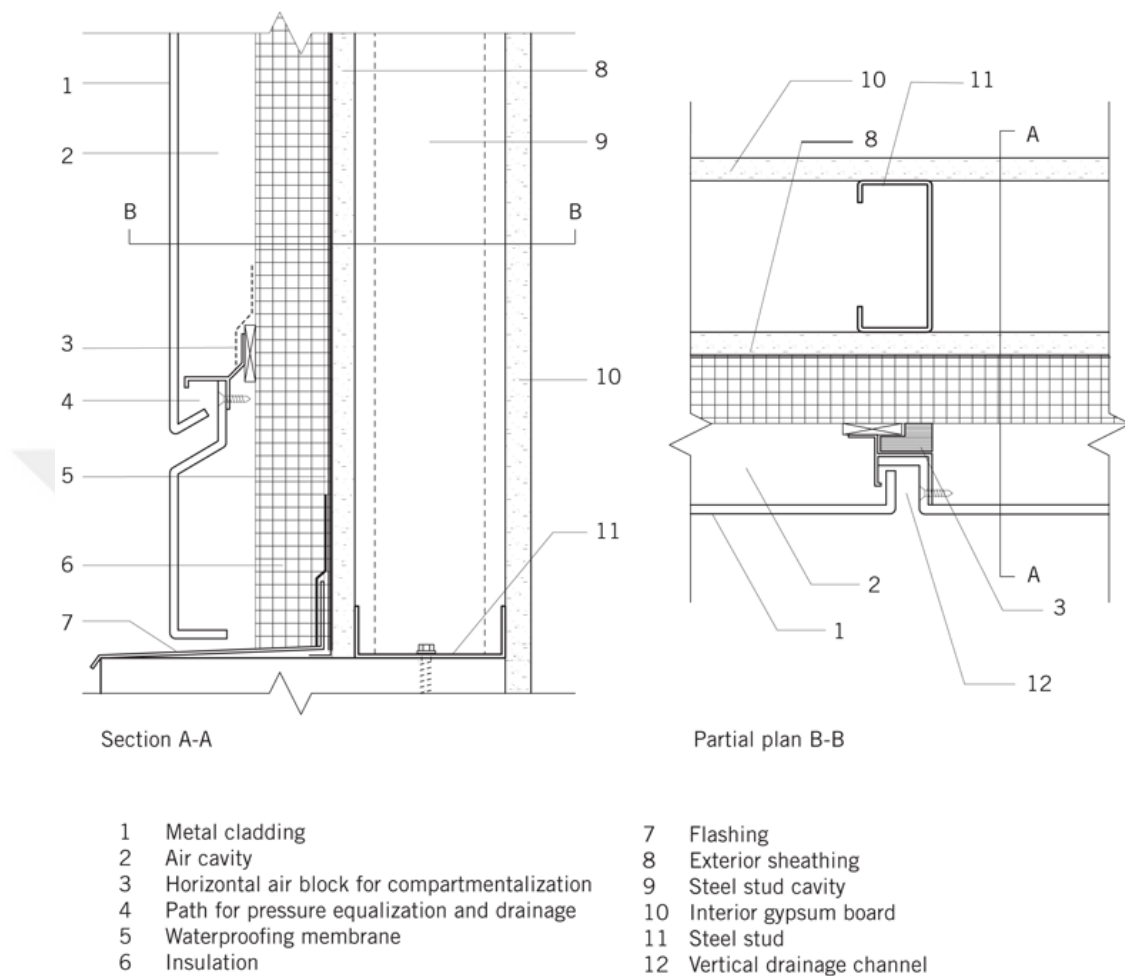

**Figure C.27.** Schematic concept of pressure-equalized rain screen (Aksamija, 2013, p.25).

TC.9.3. Using exterior and interior window coverings: refer to TC.5.3 and TC.5.4.

TC.9.4. Using air flow barriers: are used to reduce air flows between conditioned and unconditioned spaces. They must be impermeable to airflow. In an appropriate air barrier installation, it should cover the entire envelope. Can be implemented on exterior surfaces, indoor surfaces or between them. The fact about air barriers, which should be undertaken is that a building façade will never completely airtight and some amount of air leakage must be expected. Three types of air barriers are commercially available

including: Elastomeric emulsion, Elastomeric emulsion 2, and Microporous laminate (Henry Company, 2012; Aksamija, 2013).

TC.10. Reducing moisture infiltration through façade panels: the movement of moisture and vapor through the façade can be diminished by using appropriate vapor barrier systems.

In a retrofit project it is possible to remove the old vapor barrier and add a new one. As seen in the Figure C.28, first, the old internal surface and vapor barriers of existing wall need to be removed. Then, big gaps and cracks must be sealed. Finally the new studding and insulation slabs are installed. Insulation layer can be also applied to the external side of the old assembly.

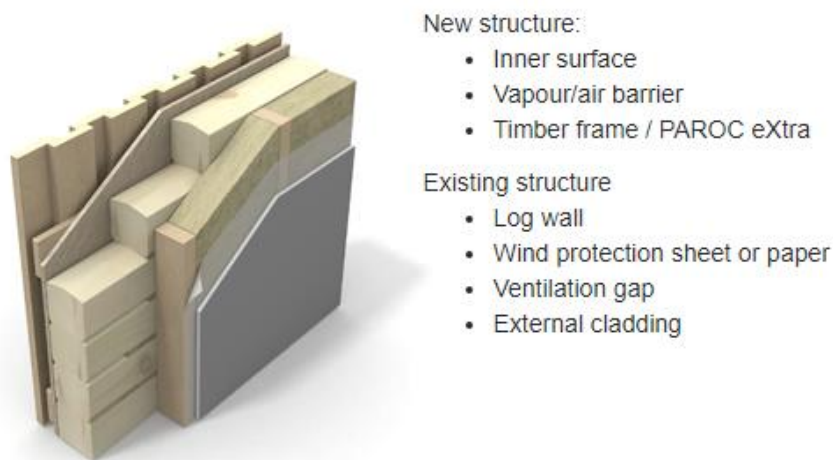
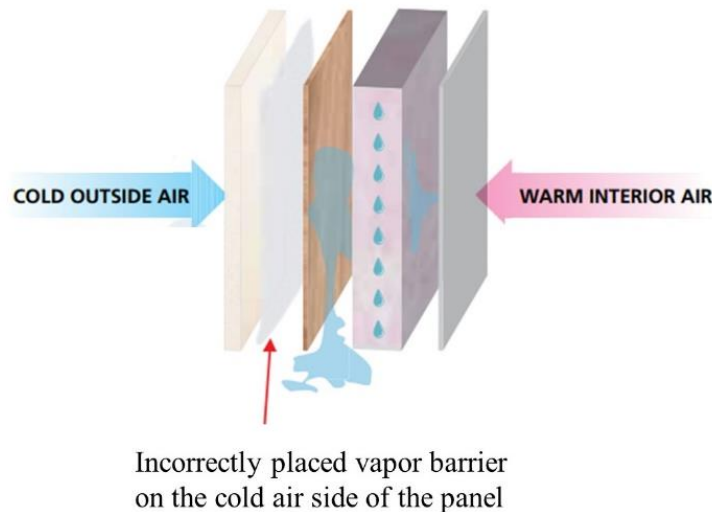

**Figure C.28.** Adding new vapor barrier from the internal side ( <http://www.paroc.com>).

TC.10.1. Using Semi-permeable vapor barriers: they are able firstly to limit the moisture movement through walls, usually as a result of condensation, and secondly to drain the penetrated water to outside and are grouped based on permeance values into three categories and dependent on the existing façade's condition can be selected.



TC.10.1.1. Semi-permeable, Semi-impermeable, and Impermeable vapor barriers: the permeance value of these products ranges between 1.0 and 10 perms (1 perm = 1 grain of water vapor per hour). Latex or enamel paint are commercially available products for this group. Semi-impermeable vapor barriers with a permeance range of between 0.1 and 1.0. Kraft-faced fiberglass batt insulation is a possible form. Impermeable vapor barriers have a permeance value of 0.1 perm or less. Sheet polyethylene or non-perforated aluminum foils are available for this group. Another significant point that should be taken into account about vapor barrier is that if they desired to be applied behind the assembly, they should be installed on the warm in winter side of the assembly.



**Figure C.29.** Position of vapor barriers (WaterTech, 2011).

TC.10.2. Using water-resistive barriers (WRB): WRBs are intended to block crossing of water that penetrates the cladding system. Penetration of water behind a WRB is, however, not unexpected, and usually happens around windows. Orientation and solar exposure are significant indicators in wall humidity rate. The results of several studies in this regard reveals that north-facing façades are more critical than south-facing façades in experiencing higher vapor and humidity.

TC.10.2.1. Adding two layers of felt (WRB) on stone cladding or stucco stud walls: recent research regarding WRBs show that stone-cladding (absorptive) walls with two layers of WRBs have a greater ability than stucco-clad (absorptive) walls with single layer of WRBs (Glass et al., 2015).

TC.10.3. Using non-absorptive cladding materials: using non-absorptive cladding materials makes the assembly performance independent from the solar exposure or orientation.

TC.10.3.1. Using unbacked vinyl siding and insulated vinyl siding cladding: vinyl siding is less expensive than other types of claddings, it's low maintenance, and it never needs painting. R-values range from R-2 to R-5, as well as noise reduction and reduced thermal bridging are all advantages of vinyl siding panels.



**Figure C.30.** Two types of vinyl siding non-absorptive panels, left: unbacked vinyl siding, right: insulated vinyl siding cladding (<http://www.builderonline.com>).

TC.10.4. Using ventilated rain-screens systems: this option is recommended when the external cladding is not a vapor barrier. There is a ventilated air cavity between inner and outer surfaces that provides the passage for water draining. In other words, the cavity acts as the first surface that stops water penetration (Roberts & Guariento, 2009).

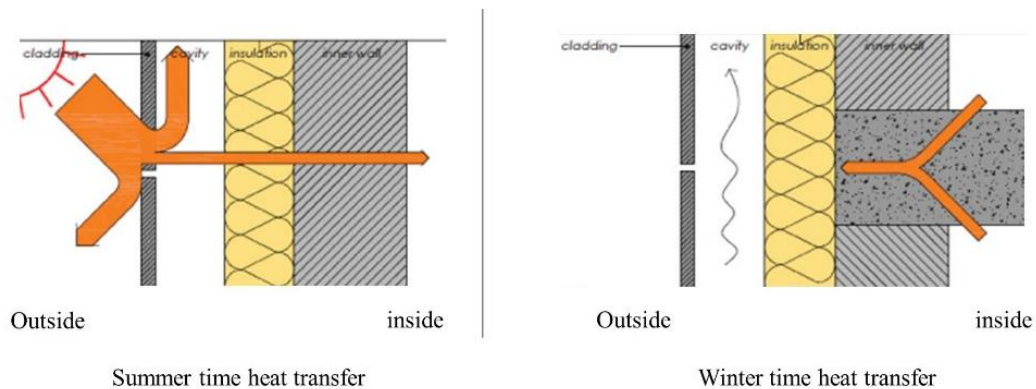

**Figure C.31.** Ventilated rains-screen solutions (<http://www.porcelanosa-usa.com>).

TC.10.4.1. Fiber Cement Panels (FCP), Terra cotta, Aluminum Composite Material (ACM): these panels provide a non-combustible, durable exterior that are engineered to be applied in rain-screen and ventilated wall assemblies. FCP's are commercially available in a wide range of aspects and colors. FCP's have been successfully used in Europe for over 35 years as a 'No' maintenance exterior, requiring no caulking or painting. Terra cotta is another option applicable on rain-screen and ventilated wall assemblies. It is a completely natural material with a non-combustible characteristic. Aluminum Composite Material (ACM) is commercially available as both field installed or as a component in prefabricated panels and are applicable on rain-screen and ventilated wall assemblies (facadetech.com).

### **TC.11. Providing fresh air flows**

In the literature, different methods of the provision of fresh air flows as passive ventilation action to avoid both problems of summer overheating and stuffiness have been remarked. Six main actions in this regard are remarked as: 1) providing active fenestration, 2) providing optimal window sash types, 3) providing optimal distribution of windows, 4) night ventilation, 5) using open façade-systems, and 6) louvered open façade systems.

TC.11.1. Providing active fenestration: this action can be implemented by using motorized shading systems or automated operable windows

TC.11.2. Providing optimal window sash types: three optimal sash types are 1) bottom hung windows (opening to inside), 2) horizontal pivoted, lower part opening to outside, and 3) casement windows or side hung opening to inside (Roetzel et al., 2010).

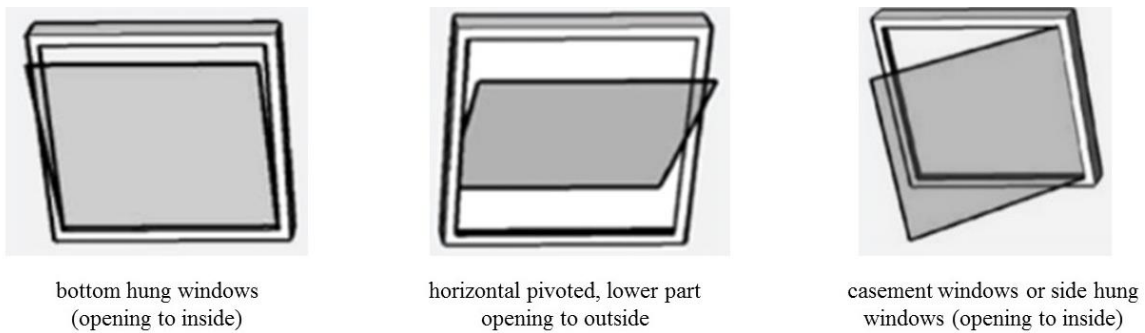

**Figure C.32.** Optimal window sash types (Roetzel et al., 2010).

TC.11.3. Providing optimal distribution of windows: Two window distribution types can be used as optimal ways of glazing distribution; 1) providing several bottom hung windows opening to inside and 2) both sides of bottom and above openings.

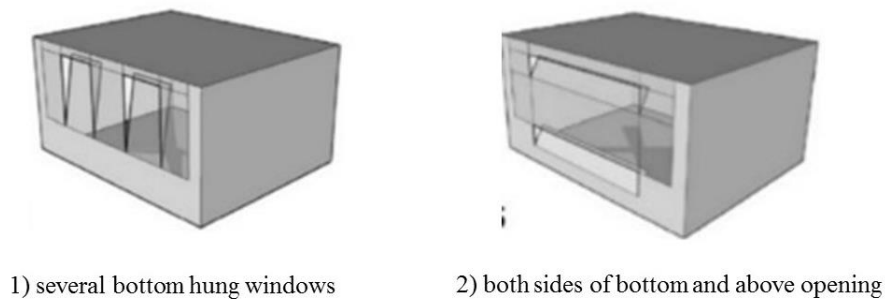

**Figure C.33.** Optimal window distribution (Roetzel et al., 2010).

TC.11.4. Night ventilation: the several studies have shown that night ventilation can reduce the overheating problem in summer. This technique removes the stored heat within the thermal mass, absorbed during the day (Shaviv et al., 2001). Buildings with higher cooling demands in summer have the higher potential contribution of night ventilation (Santamouris et al., 2010).

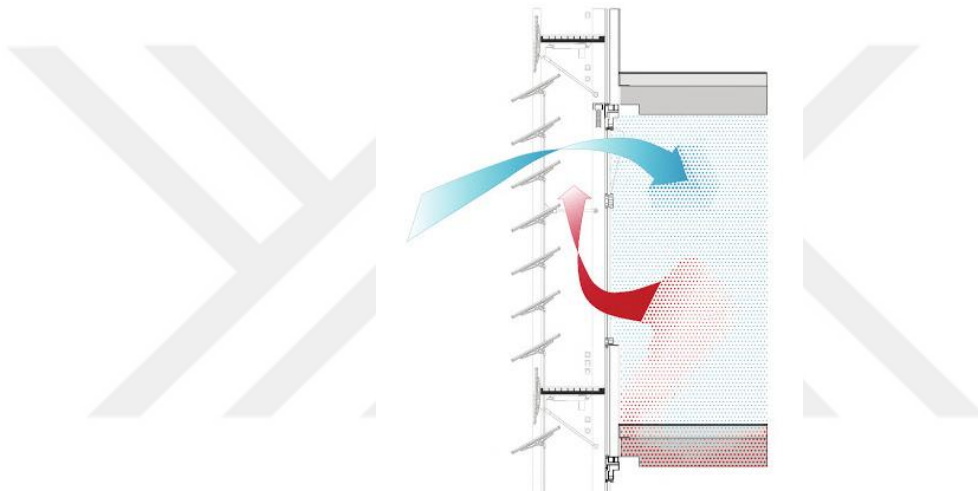
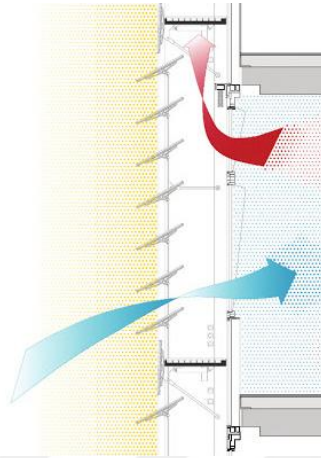

**Figure C.34.** Summer night cooling in a double-skin façade system (Vassigh & Chandler, 2012, p.77).

TC.11.5. Using open façade systems: the open joint single-skin façade systems are mainly based on rain-screen façade technology. Rain-screen cladding is the attachment of an outer skin of cladding with a ventilated and drained cavity to a new or existing building. Therefore, the absorbed heat is dispersed in the cavity and ventilated through the openings.

TC.11.6. Using open-louvered façade systems: this system comprises of two outer and inner layer (Figure C.35). The outer layer consists louvered glass blades. In summer, due to provide air flows, the louvered glass blades in outer skin and the upper openings

in inner skin must kept open. The air flow between the two layers provide cool breezes in interior spaces (Vassigh & Chandler, 2012).



**Figure C.35.** Open-louvered façade system (Vassigh & Chandler, 2012, p.77).

### **Thermal comfort in single-skin curtain wall systems**

Curtain walls as a lightweight nonstructural skin with usually aluminum frame are attached to the primary structure. They consist of three main elements of vision glass, spandrel, and mullions. Based on their installation type, they are classified into stick or unitized façade systems. The former refers to the in-situ built system, but the former type refers to modular glazed units in factory. The major problems related thermal behavior of curtain walls, arises from inappropriate design and interactions among all the components including mullions, glazing units, spandrel areas, anchor joint elements, and perimeter closures. As glazed façades with a large glazing area, glazing units of the mentioned components, are the main heat transfer bridges in winter or summer. For this purpose, mainly, the thermal properties of glazing units must be considered. These properties or thermal comfort indicators are the solar heat gain

coefficient (SHGC), the shading coefficient (SC), the window-to-wall ratio, and the light-to-solar-gain (LSG) ratio (Aksamija, 2013, p.31).

Thermal bridging problem: when a highly conductive material like metal membrane penetrates into the insulation layer of wall in façade, thermal bridging occurs, which negatively affects thermal behavior of the assembly. In curtain walls those aluminum mullions or framing parts that are not thermally broken or not thermally improved, with their high conductivity, transfer the outside heat to inside space and diminish the overall thermal performance (Aksamija, 2013, p.30).

### **TC.12. Reducing conductive and convective heat transfer through mullions and other opaque parts of curtain wall**

TC.12.1. Expose only a small part of metal frames to the exterior: metal frames (usually aluminum) due to the high thermal conductivity are the other heat transfer sources of curtain wall façades. To prevent the problem it is recommended to expose a limited part of metal mullions and frames to the exterior part of the façade. Consequently, they should be brought to the interior (Harvey, 2012, p.85).

TC.12.2. Using super insulated panels behind the spandrels: in the case of curtain walls it is important to reduce U-value while, keeping the assembly thickness as thin as possible. Super insulated panels are appropriate options for these cases.

TC.12.2.1. Vacuum-insulated panels (VIPs): a core of insulation material (silica or glass fiber) enclosed in an airtight, vacuum-sealed film envelope. As mentioned in previous sections, the only negative point related to the VIPs is their performance durability, which can be decayed due to vacuum loss over time or by mechanical damages (Capozzoli et al., 2015).

TC.12.3. Increasing opaque part (spandrel areas) with additional insulation on the inside: high-performance curtain walls typically have larger opaque (spandrel) areas

with additional insulation behind them (from inside). As remarked in TC.12.2.1, VIPs can be used as insulation layers behind spandrel areas (Harvey, 2012, p.86).

TC.12.3.1. Using back-coated glass for spandrel areas: ceramic frits (coating) can be added on either a single lite of glass or an insulating one on the inner part of the unit. Ceramic frit coating makes the glass to appear as an opaque spandrel and for both types of single or double-glazed glass spandrel, addition of an insulation layer is better to improve its thermal performance (Aksamija, 2013, p.28).

TC.12.3.2. Using single lite of back-coated glass: the inner surface of glass is completely coated with ceramic frit to make an opaque spandrel. An additional insulation layer is recommended to improve its thermal performance.

TC.12.3.3. Applying shadow boxes: in order to hide spandrel areas, opaque glass or shadow boxes are mainly used. Shadow box refers to the dark enclosed space behind the transparent or translucent glass. Shadow boxes also provide a perception of depth behind the glass (Harvey, 2012). A layer of insulation should be applied behind the bow (Aksamija, 2013, p.28).

TC.12.4. Applying thermal breaks: to enhance the thermal behavior of aluminum mullions thermal breaks should be applied. This is achievable by putting a layer of silicone between the outside glass and aluminum framing (Aksamija, 2013).

TC.12.4.1. Using low-conductive separator materials: thermal breaks typically are made of low-conductivity materials like urethane, neoprene, rubber, or polyester-reinforced nylon (ASHRAE 2001b, chapter30).

TC.12.4.2. Using pressure bars: pressure bars or plates retain the glass by fastening to the outside of the mullion. These components consist of gaskets, which are set between the mullions and pressure plates. These gaskets act as thermal breaks.

TC.12.5. Using thermally improved materials: since the metal-to-metal fasteners used to span the thermal break increases thermal conductivity, a thermal break material is



required to separate exterior and interior framing parts. Compared to the thermal break actions, as described above, this action is less costly and also less effective (Aksamija, 2013, p.26).

TC.12.6. Using insulated spacers and frames (non-metallic insulated spacers): spacers in the literature are divided into two main groups: metal and non-metal spacers. Metal spacer group can include aluminum, galvanized steel or stainless steel. Thermally improved metal spacers, hybrid spacers and thermally broken aluminum spacers are set in this category. However, to be up-to-date with commercially available innovative technologies, it seem wise to use non-metallic spacers, which are low-conductive and present a good thermal behavior compared to metal versions. Non-metallic spacers comprises three subdivisions of composite, structural foam, and thermoplastic. Besides their high thermal performance, they have a high resistance against moisture and water penetrations (Van Den Bergh et al., 2013).

### **TC.13. Reducing conductive and convective heat transfer through vision glazing areas**

Although a large glazing area in curtain is desirable in provision of daylight, outside view, and general building aesthetics, however, as mentioned before, it is the main source of heat transfers through the building façade. Below sections describe the ways and options to enhance the thermal behavior of vision glass areas in curtain walls.

TC.13.1. Using tinted glass: to block the direct sun rays integrally tinted glass can be preferred. Whilst, it also blocks daylight and out views. Glass tinting is the lowest cost but the least efficient option that can be applied to a single lite of glass to improve its thermal performance (Aksamija, 2013).

### **TC.14. Reducing air flows and water infiltration through opaque areas**

Most of the discussed options for cladded façade systems can also preferred for curtain walls, however, the main difference between these two façade systems is that cladded

façades have discontinuous window units, which rely on sill flashings on top of the windows. In the case of curtain walls with a large glazing area, there is not the possibility of providing sill flashings on top of the each window units.

TC.14.2. Adding "back pans" around the perimeter behind opaque areas: are usually aluminum or galvanized metal sheets attached and sealed to the curtain wall framing around the perimeter behind spandrel areas. Back-panes account as a second line of defense for water penetration.

TC.14.3. Using water-managed systems: their performance is based on the pressure differential between the glazing units and interior, which creates required force to drain water to outside. Furthermore, these products are not air barriers, but only act as water drains incorporating drains from the glazing pocket.

TC.14.3.1. Watertight frame corners: curtain walls unlike the discontinuous window units in cladded façades, suffer from the lack of sill flashings around each glazing unit. Consequently, rain water intends to leak to the inside from the curtain wall frame corners. One solution is "watertight frame construction".

TC.14.4. Providing frame drainage systems: are designed to handle rainwater as well as condensation and must be placed at the curtain wall perimeter with sufficient slope to the exterior.

TC.14.4.1. Selecting frames with wept glazing: to collect and drain the penetrated water to the exterior frames with wept glazing must be selected and pocket sills must be sloped to the outside.

TC.14.4.2. Using horizontal mullions (not vertical ones) as drain conductors

TC.14.5.1. Integrating curtain wall sill flashings with sill flashings of adjacent walls: curtain wall perimeter flashings must be sealed to the air and vapor barriers at adjacent walls and to improve their performance, head and sill flashings must be sloped to the exterior (wbdg.org).

TC.14.6. maintaining continuity of the air barrier at curtain wall perimeter: it will reduce air flows around curtain walls.

TC.14.6.1. integration of perimeter flashings: in order to be sure of the watertight performance in curtain walls and its connection to the adjacent wall components, perimeter flashings need to be integrated. Additionally, placing appropriate insulation around the perimeters will also reduce energy loss and condensation.

TC.14.7. Placement of setting blocks with weep holes: the snap cover weep holes help to weep out the entered water at the gasket corners. These weep holes in a water-managed system act as water drainer (that have entered to the glazing pocket), however, in a pressure-equalized system performs as vent holes in provision of air flows between the glazing pocket and exterior (wbdg.org).

### **TC.15. Reducing air flows and water infiltration through glazing units**

TC.15.1. Using pressure plate glazing (easiest method) for two-sided SSG: is the easiest method to seal an air barrier from adjacent construction into the air barrier of curtain wall system, however, in the case of using dry gaskets, corners and joints might still leak air flows. Using wet sealants at joints or adding four-sided gaskets can help to prevent probable leakage. Two alternative options for this action are 1) using wet sealants at corners or joints in dry gaskets and 2) using four-sided gaskets

TC.15.2. Using structural silicone glazing (especially in unitized systems with 4-side SSG): when a glass or spandrel unit is adhered to the frame by means of a bead of silicon, it is called a structural silicone glazing system.

### **TC.16. Preventing the condensation**

Condensation problem can be the result of the high humidity of the interior spaces. Whilst, the main reason usually is due to the failure of the glazed external wall such as, failures in sealants, insulation, materials, glazing units, or appropriate applications. Following sections describe related actions in this regard (Sanders et al., 2012).

TC.16.1. Using thermally broken or thermally improved aluminum frames: refer to the sections TC.12.5.2, TC. 14.6.1, TC.12.6, and TC.4.1.1.

TC.16.2. Adding insulation between curtain walls and the adjacent cladding system at behind: In addition to provide thermal breaks at the perimeter of curtain wall, to keep thermally broken aluminum frames away from the cold air of the outside, special insulations must be applied between curtain wall and adjacent cladding systems.

TC.16.3. Minimizing the proportion of framing exposed to the outdoors: only a small part of metal frames must be exposed to the exterior.

TC.16.4. Applying insulation at the curtain wall perimeter: the perimeters of the curtain wall must be covered with sealed flashings.

TC.16.5. Adding insulation behind the shadow boxes: by incorporating a metal sheet into the at the back of a transparent glass unit, behind the considered unit will have deeper appearance, which is called as “shadow box.” Adding insulation behind these shadow boxes is essential. In order to improve its performance, an interior back-pane must be applied behind the added insulation layer.

TC.16.5.1. Adding insulation layer between back-panes and exterior cladding: since, spandrels are not exposed to the interior of the building, they are more intended to experience condensation than vision glass units. Back-panes as metal sheets prevent water infiltration in spandrel units and in order to keep the dew point away from back-pane and make it a good air / vapor barrier it is recommended to apply an insulation between the back-pane and exterior cladding (Sanders et al., 2012).

TC.16.6. Using ventilated façade systems: The open joints in these systems provide natural ventilation for the intermediate space between panels and insulation. These system also act as rainwater and condensation drainage systems (HunterDouglas Fassaden, 2014). Refer also to the section TC.11.5.

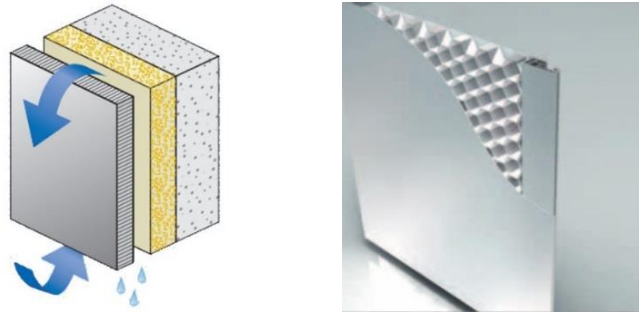

**Figure C.36.** Left: schematic performance of a ventilated façade system, right: product example made of a pre-coated aluminum and reinforced with an aluminum honeycomb structure (HunterDouglas Fassaden, 2014).

TC.16.6.2. Using louvered spandrel panels: refer to TC.11.6.

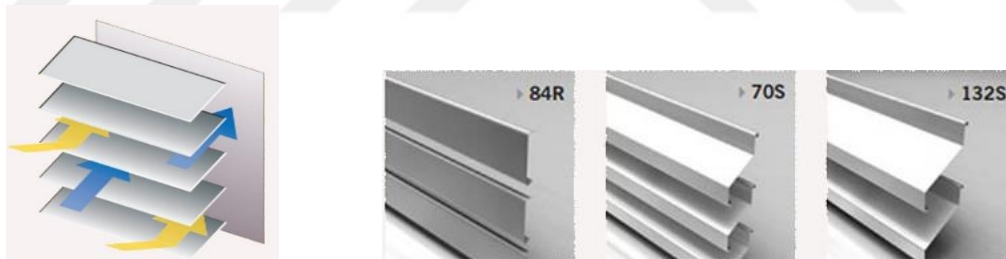
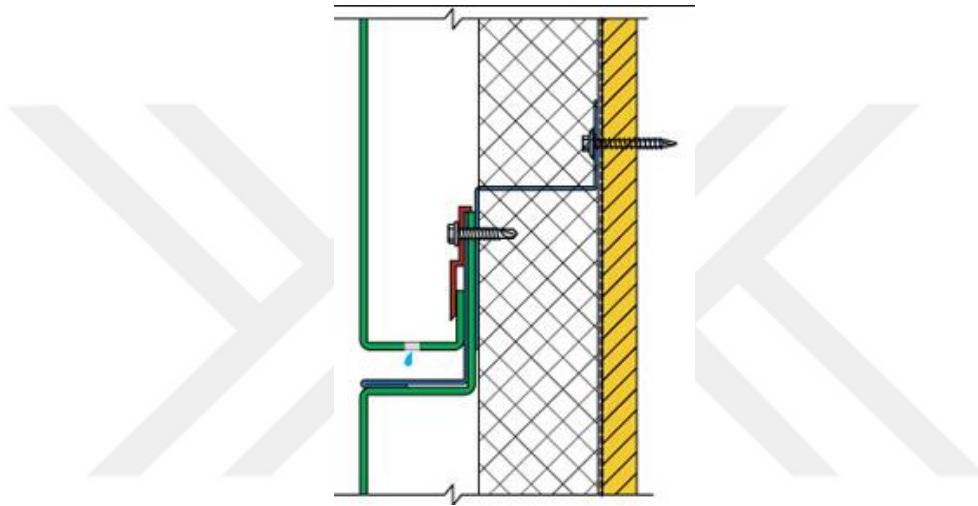

**Figure C.37.** Louvered spandrels (HunterDouglas Fassaden, 2014).

### TC.17. Providing condensation drainage

Condensation drainage systems are intended to collect the condensate from spandrel units of curtain walls to the outside. The required performance is weeping condensate from spandrel areas to the exterior. For this purpose, two options are possible: 1) using wept-glazed systems by applying Gunable wet seal over back-up rod or glazing tape and 2) using condensate gutters and weeps. If these gutters and weeps are outboard of

back-pan, they will also act as an air barrier, otherwise their function will be only as condensation drainage component. There are several methods for panel joints of curtain wall system and each has its particular guttering type. As an example, Figure C.38 shows guttering details for an “overlap panel joint” type.



**Figure C.38.** Condensation guttering details for overlap panel joints (Ceruti, 2012).

### **Thermal comfort in double-skin façade systems**

Double-skin facades consist of inner and outer walls separated with an air space. The gap can range between 0.3 and 1.5 meters and the air in this gap is neither heated nor cooled (Baker, 2009, p.63). Both outer and inner façade layers like any single-skin façade types can be comprised of either single-glazed, double-glazed, or triple-glazed window units from the fixed or operable versions. The inner layer can be partially opaque. Poirazis (2006) divides double-skin facades based on their cavity arrangement into four main categories as following:

- *Box windows:* These types by means of vertical and horizontal partitions are divided into independent boxes and consist of inward-opening

casements (Louver, Deyener and Wouter, 2004). The external single-glazed layer can have openings at lower or upper part of the façade. Since the air movements do not occur between two window boxes, the sound and smell transmission is also prevented (Harvey, 2012, p.91).

- *Shaft-box façades*: these types can be only installed to the naturally ventilated facades. Air space is divided vertically through the façade in shaft-box windows, which are connected to tall ventilation shaft on the façade. They do not perform efficiently regarding acoustic and fire safety issues (Alibaba and Ozdeniz, 2011).
- *Corridor façades*: these types consist of a horizontally partitioned large cavity, which create corridors through the façade. The sound transmission from one office to another may need to be considered as the disadvantage point of these types.
- *Multi-stories façades*: these type are divide neither horizontally nor vertically, but they are composed of fewer openings that by providing stack effect lead the façade to be ventilated. They are also great alternatives for buildings, which are suffering from external noises, however, like corridor types may require attention regarding the sound transmissions from one office to another.

## **TC.18. Reducing heat losses through the double-skin facades in winter**

TC.18.1. Trapping the heat by keeping the cavity openings closed during the heating seasons: the secondary façade layer (outer glazed-layer) by absorbing the sunlight during winter makes the air between two layers heated. By keeping the openings of inner façade closed, the preheated air will be trapped between two facades, which can be directed to the interior (Harvey, 2012, p.92).

## **TC.19. Reducing heat gains through the double-skin facades in summer**

TC.19.1. Adding motorized louvers inside the outer façade: by installing dynamic louvers or other shading devices inside the outer façade the sunlight will be reflected and partially absorbed during the summer. The absorbed sunlight will heat and draw the cavity air to exit from the upper part of the cavity, thus, the cooler outside air from the lower part of the façade can be penetrate to the cavity.

TC.19.2. Using double-skin façade types with larger gap areas: the larger gap spaces between two façade layers in double-skin façade types, not only provides a walkway accessible by doors or windows and stairways, but also provides partial shade on inner façade glazing area.

TC.19.2.1. Corridor and multi-stories types: these types have a gap space as much as 60cm to 100cm, which is wider than other types and can provide larger shading area on inner façade windows (Harvey, 2012, p.92).

TC.19.3. Keeping intermediate gap thickness at least 200 mm: to avoid summer overheating within the double-skin façades, it is essential that the distances between inner and outer facades not be lower than 200mm (Jager, 2003).

## **TC.20. Preventing the condensation on outer façade**

TC.20.1. Closing inner windows when the outside openings are closed in winter: when the outside temperature is low and the openings of outer façade is closed (because of the external conditions), the inner windows must be kept closed.

TC.20.2. Preventing rainwater penetration form the entrance and exit slots: The slots on upper and lower parts of the double-skin façade must be engineered to prevent both water penetration and creation of turbulence effect within the cavity (Harvey, 2012, p.93).



TC.20.2.1. Applying automatic flaps: providing continuous air inlets and outlets, respectively, at the lower and upper parts of the façade along with automatic flaps will result a dynamic façade system, which can open or close inlets regarding the outside temperature (Oesterlie et al, 2001).

TC.20.3. Using night ventilation: one of the major benefits of double-skin facades is provision of a secure night ventilation opportunity, which also prevents the entry of insects or birds (Harvey, 2012, p.95).

### **VC.1. Increasing daylight gains by redirecting diffuse skylight into the interior (rejecting direct sunlight)**

Redirecting diffuse sunlight into the interior is an effective way for mixed climatic regions with high solar angles of summer and low solar angles of winter. These refractive devices redirect low-angle winter sun rays from the brightest parts of the sky and bring it into the inside and in summer, redirect and admits sun rays only from the lower parts of the sky.

VC.1.1. Providing top-lighting: To distribute daylight into the interior spaces, top-lights are ideal options. Many of them can provide adequate daylight with minimum glare or overheating problems. However, their roof area should not exceed 5%.

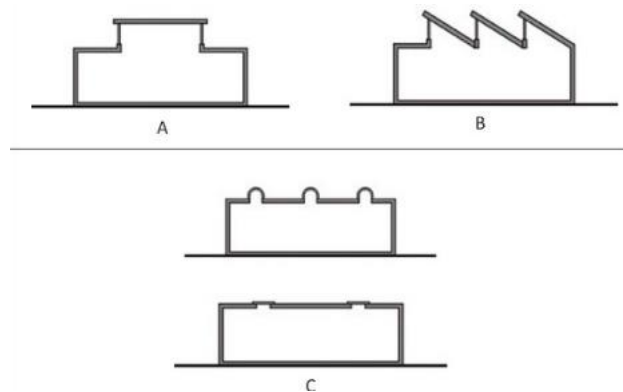

**Figure C.39.** Different types of top-lighting (Hastings, 1994, chapter 21).

VC.1.1.1. Vertical double clerestories: are vertical glazed steps applied in the roof to distribute natural daylight into the interior spaces. North-facing versions are most ideal in terms of providing adequate daylight with minimum summer overheating and minimum glare problems. However, by aid of sun-catcher baffles it is possible to direct seasonal sun rays independent from the building orientation.

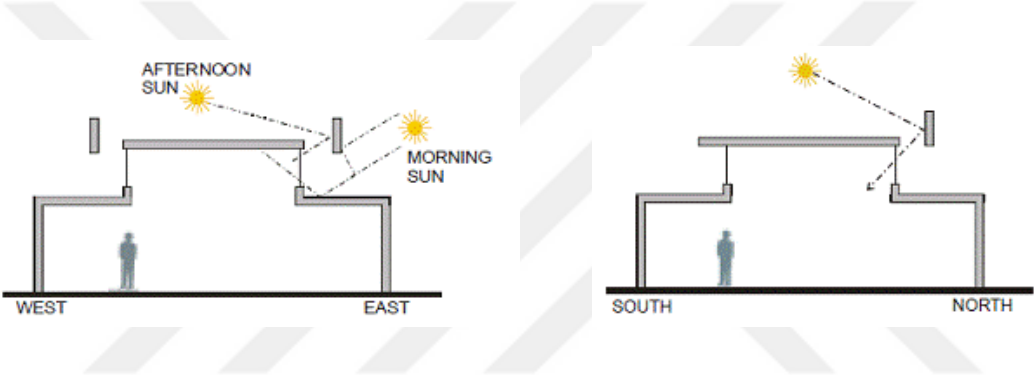

**Figure C.40.** Left: east-west vertical clerestories with sun-catcher baffles. Right: north-south vertical clerestories with sun-catcher baffles ([elad.su-per-b.org](http://elad.su-per-b.org)).

VC.1.1.2. Saw tooth clerestories: they can be either vertical or sloped glazing units that are separated by sloped roof components. They can illuminate substantially large floor areas.

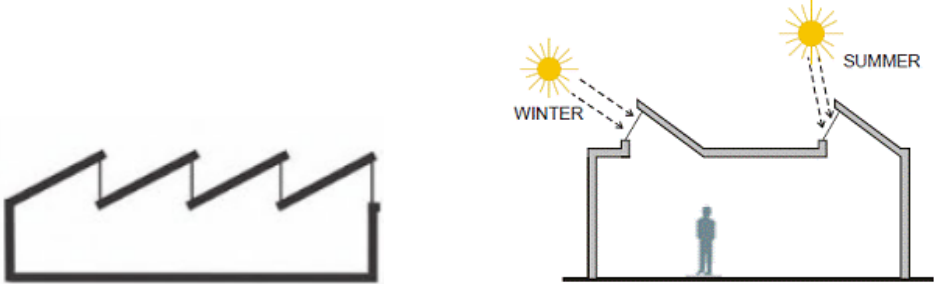

**Figure C.41.** Saw tooth clerestories with sun-catcher baffles ([elad.su-per-b.org](http://elad.su-per-b.org)).

These can be used in two forms as seen in the following figure. In option 1 south-facing angled ceiling provides more indirect sunlight and allows less glazing area. If the building skylight is north-facing and cannot provide adequate daylight, option 2 can be recommended. Angular selective saw tooth in option 2 redirects much of the low angle sun rays onto the diffuser.

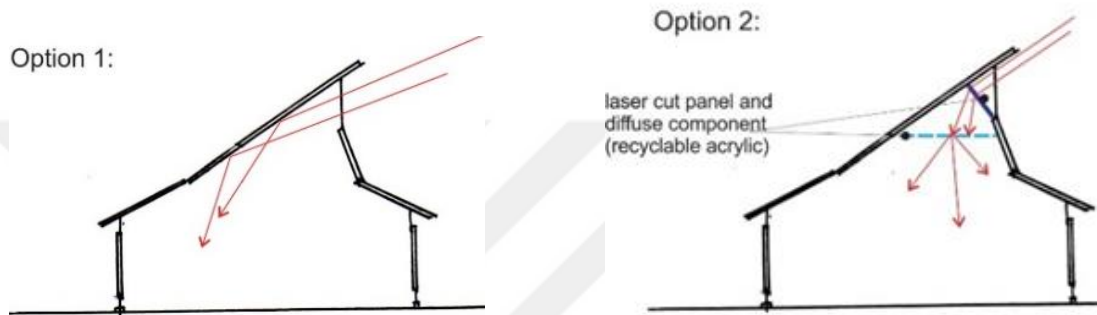

**Figure C.42.** Different uses of saw tooth top-lights (Hastings, 1994, chapter 21).

VC.1.1.3. Skylights: can be in a variety of forms like domed, however, when selecting them, it is noteworthy to say that horizontal versions receive sunlight directly, are not energy efficient. Thus, integrating them with louvered sun control systems can minimize glare and overheating problems.



**Figure C.43.** Left: normal skylight example, right: louvered skylight examples (respectively, [misdar.com/sun-louver.htm](http://misdar.com/sun-louver.htm), and [shw.com.my/pro-alu-sun-louvers.htm](http://shw.com.my/pro-alu-sun-louvers.htm)).

VC.1.1.4. Vertical reflective baffles: outside polar-facing clerestories redirect sunlight into the vertical baffles.



**Figure C.44.** Reflective baffles (lightshowwest.com).

VC.1.1.5. Translucent aerogel skylights: they are high thermal resistive (R20) and completely moisture resistive. The sound transmission reduction is other features regarding these products. Whilst, they require a larger roof area.

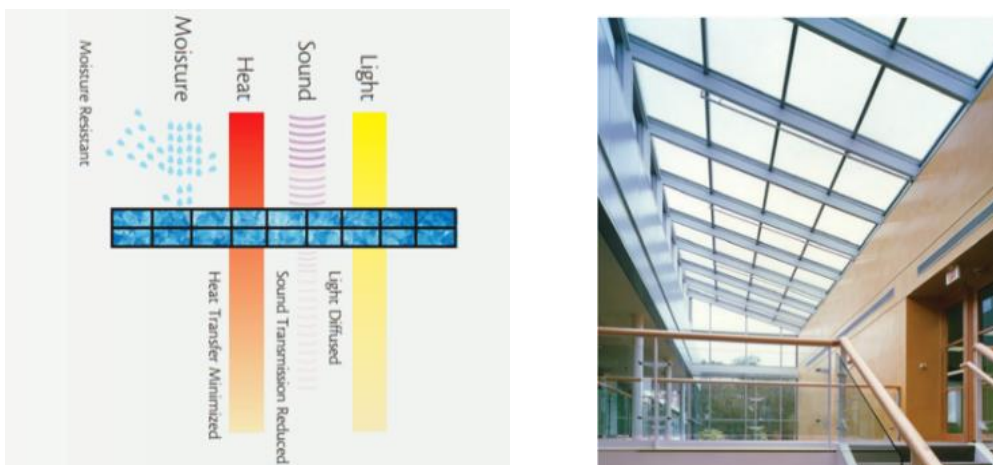

**Figure C.45.** Translucent aerogel skylights schematically (Wasco Products, waskoskylights.com).

VC.1.1.6. Domed skylights: compared to flat version, domed skylights provide more daylight at lower sun angles.

VC.1.1.7. Anidolic zenithal openings: these openings on the upper part of the window without allowing to penetration of direct sun rays, collect diffuse daylight from a large portion of the sky.

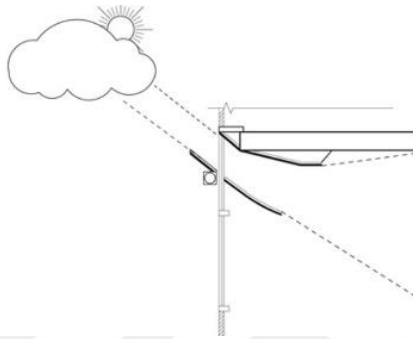

**Figure C.46.** Anidolic integrated openings (Aksamija, 2013).

VC. 1.2.1. Anidolic ceilings: they can be used to redirect diffuse light and are able to collect and transmit daylight with minimum light loss across the distance. They might be applied from either interior or exterior parts to the vertical window. With the aid of a concentrator integrated with a specular light duct in ceiling part, the light can be transported to the back side of the room. (Harvey, 2012, p.400).

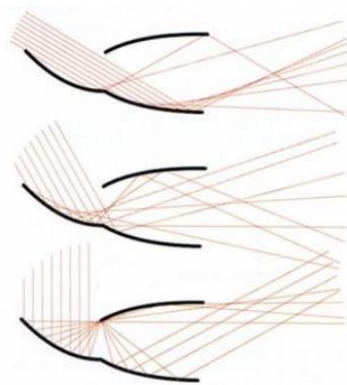

**Figure C.47.** Anidolic ceiling examples (Baker and Steemers, 2002).

VC.1.2.2. Zenithal light-directing glass: most of the commercially available active light transporters are comprised of hollow mirrored or hollow prismatic light pipes. They are used to redirect diffuse light from the zenithal region of the sky into the depth of inside space. A sandwiched holographic film between two glass units makes the main component for this device. The device can also installed in front of the upper part of a vertical window with a sloping angle of almost 45. Since they block the view to out, they should be installed to the upper part of the window (Harvey, 2012, p.400).

VC.2.1.1. Horizontal skylights with holographic optical elements (HOEs): horizontal versions receive sunlight directly, are not energy efficient. Thus, integrating them with louvered sun control systems can minimize glare and overheating problems.



**Figure C.48.** Horizontal skylight example ([shw.com.my/pro-alu-sun-louvers.htm](http://shw.com.my/pro-alu-sun-louvers.htm)).

VC.2.2.1. Light shelves: Horizontal or oblique reflective surfaces, which can be installed near windows at the upper part, whether from outside or inside. During winter sunlight can pass through the shelves, but during summer, direct sunlight is blocked and reflected to the ceiling surface and then into the interior space (Aksamija, 2013, p.57).

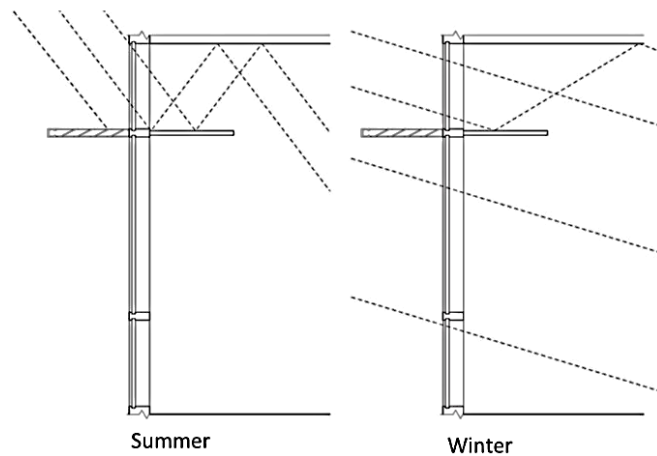

**Figure C.49.** Light shelf performance during summer and winter (Aksamija, 2013)

Interior light shelves are simplest and less expensive than external ones. But their efficiency in reducing cooling loads is less than external types. Both types are most effective if they applied on south-facing façades. The other advantages of light shelves are their ability in reducing glare and lighting contrasts in interior spaces, since they eliminate the light degree near the windows. External light shelves act better in shading provision and the sunlight absorption mainly occurs outside of the building, for the cases with high cooling loads, the external light shelves are more ideal. Their daylight provision is also greater than internal types (Harvey, 2012, p.393).

VC.2.2.2. Light-directing louvers: these are also designed to reflect the sun light onto the ceiling surface as much as possible, while do not allow light to pass horizontally and consequently reduces glare effect (Harvey, 2012, p.393).

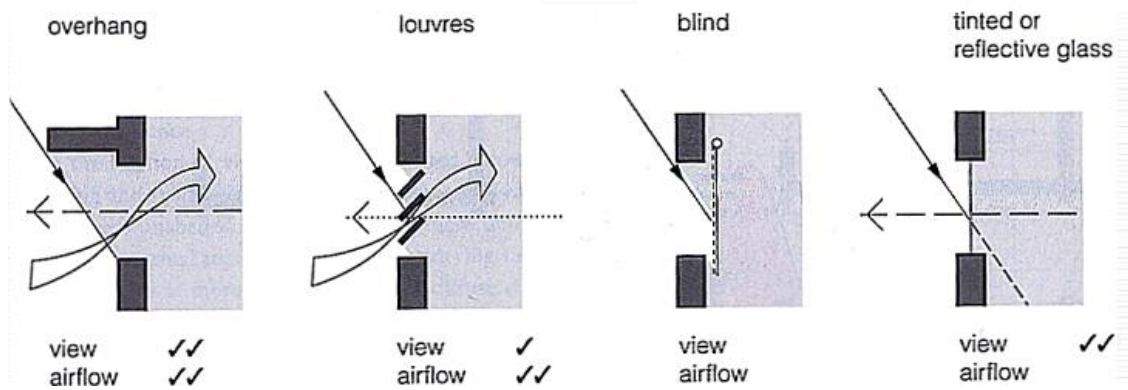

**Figure C.50.** Light-directing louvers; Okasolar system (IEA, 2000a).

VC.2.2.3. Automatic venetian blinds: tilt-angle of venetian blinds can be adjusted by these automatic controls according to the outdoor light level. Due to prevent cleaning requirements, they need to be applied between glazing layers in windows (Harvey, 2012, p.393).

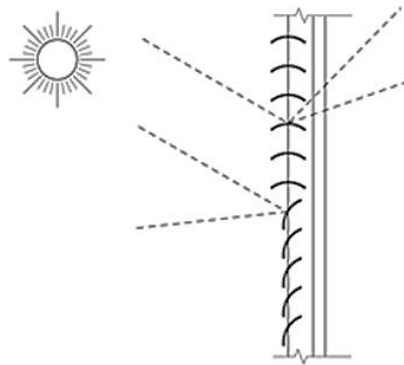
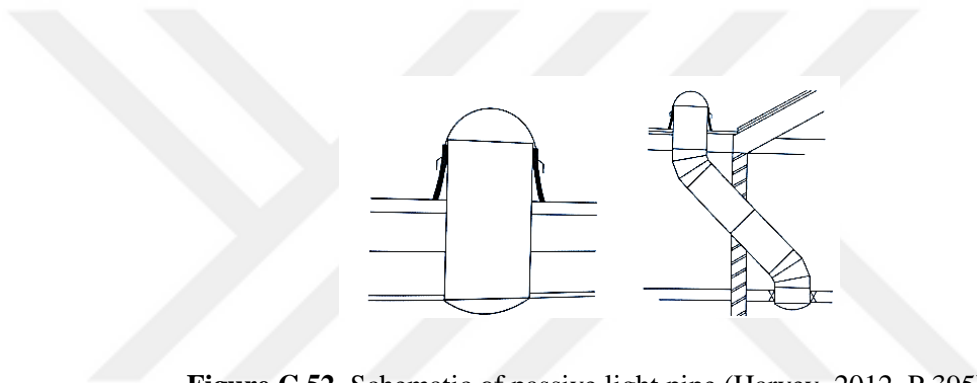

**Figure C.51.** Automatic blinds (Aksamija, 2013).

VC.2.2.4. Passive light pipes: Light pipes, as highly reflective components, channel and transport natural light from outside to the part of the room with limited windows and increase daylight level of the room without generating heating loads, especially in



buildings with a deep plan shape. The efficiency of light pipe system as a light source in buildings has been proven by several studies. They can provide 25%-50% of the work plane illuminance and consequently reduce the lighting energy consumption (Oakley et al., 2000; AlMarwaei et al., 2006). High initial costs, maintenance and user awareness are main challenges regarding these systems. As seen in the above figure, passive light pipes consist of a collector (a clear dome), a light tube (light pipe), and a diffuser (that spreads the light into room) (Harvey, 2012, p.393).



**Figure C.52.** Schematic of passive light pipe (Harvey, 2012. P.395).

VC.2.2.5. Active light pipes: active versions comprised of sun-tracking mirrors that focus light onto a reflective hollow tube that transports the light through internal reflections into the interior core of the commercial buildings.

VC.2.2.6. Prismatic panels: They can be used to change the incoming light direction and redirect it to the ceiling surface. They can also be used as fixed sun-shading devices, typically, inside a double-glazed roof. The skylight versions of prismatic panels are still tested and are not commercially available (Harvey, 2012).

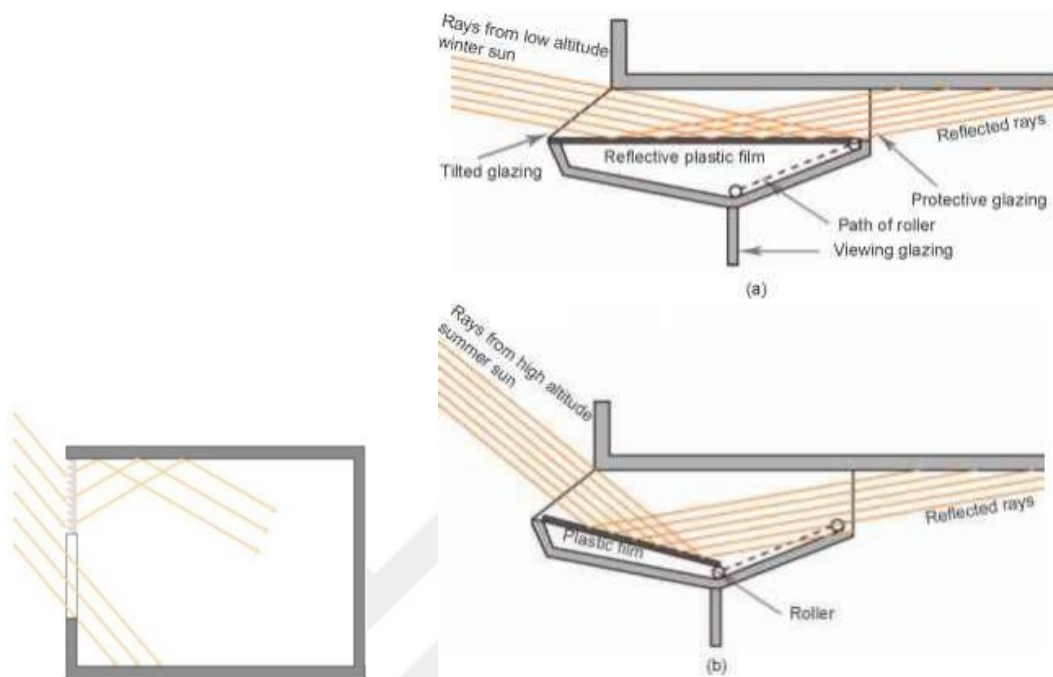

**Figure C.53.** Simple prismatic system schematically (northernarchitecture.us).

VC.2.2.7. Laser-cut panels: they are used to redirecting sunlight through making laser cuts in thin acrylic panels. They are comprised of array of rectangular elements. Surface of each laser cut is a small mirror. A partial outside view is also possible through the panel. They are not commercially available (Harvey, 2012, p. 396).

VC.2.2.8. Light-guiding shades: are comprised of a diffusing glass aperture with two reflectors. Light-guiding shades with their dual function provide shading for the window and directing the sunlight rays into the ceiling surface of inside space at the same time. Angles are adjusted for best light distribution and to prevent glare (Edmonds and Greenup, 2000).

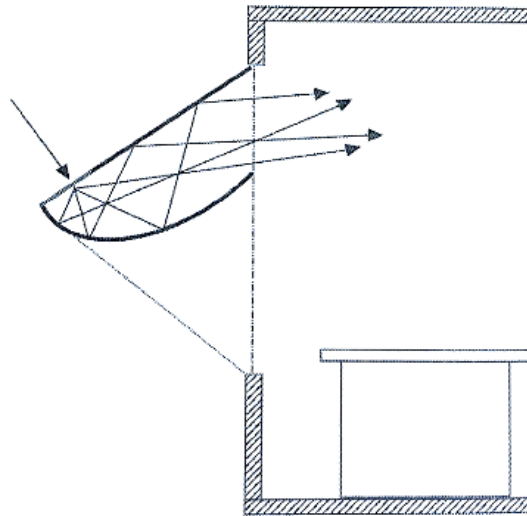

**Figure C.54.** Schematic performance of a light-guiding shade; shading while directing light to inside (Edmonds and Greenup, 2000).

VC.2.2.9. Anidolic solar blinds: they are useful in provision of angular-selective light transmission (for side-lighting) to control glare. Their small scale and also three-dimensional reflective elements are their advantages compared to other anidolic systems (ceilings or openings).

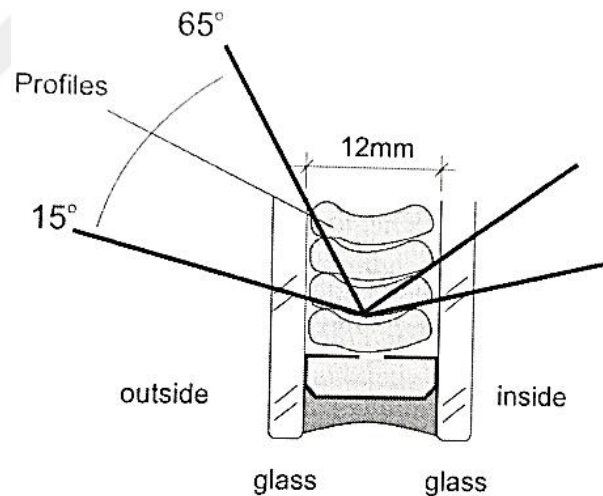

**Figure C.55.** Anidolic solar louvers (<http://www.hulic.co.jp/en/csr/topics/>).

### VC.3. Increasing daylight gains by dual functionality devices

VC.3.1.1. Holographic transparent shading: these films can be used for both purposes of redirecting diffuse sunlight or reflecting direct sun rays from a small angular domain but transmitting from all other angles (Harvey, 2012).

VC.3.1.2. Sun-directing glass: is comprised of a double-glazed pocket with a set of concave acrylic elements placed over each other between the glazing units. The sunlight rays are directed to the ceiling. To improve its performance, tilted reflective components can be applied on ceiling surface to receive light and concentrate it on a particular task area (IEA, 2000a).



**Figure C.56.** Schematic performance of a sun-directing glass (IEA, 2000a).

**Table C.1.** Different types of daylighting systems (by the author based on Hastings, 1994; IEA, 2000a; Ruck et al., 2000; Edmonds and Greenup, 2000; AlMarwae, and Carter, 2006; Harvey, 2012; and Aksamija, 2013).

Daylighting Technique	Passive / Active	Top-L / Side-L	Direct radiation	Diffuse radiation	All climates	Mixed climates	Outside view	Glare protection	Energy saving potential
Vertical double clerestories	P/A	T	N	Y	Y	---	---	D	Y
Sawtooth clerestories	P/A	T	N	Y	Y	---	---	D	Y
Skylights	P	T	N	Y	Y	---	---	D	Y
Translucent aerogelskylights	P	T	N	Y	Y	---	---	Y	Y
Domed skylights	P	T	N	Y	Y	---	---	D	Y
Horizontal skylights (HOEs)	P	T	Y	N	Y	----	Y	D	Y
Anidolic ceilings	P	S	N	Y	----	Y	Y	----	Y
Anidolic zenithal openings	P	T	N	Y	----	Y	N	Y	Y
Zenithal light directing glass	P	S	N	Y	----	Y	Y	----	Y
Light shelves	P	S	Y	N	Y	----	Y	D	Y
Light directing louvers	A	S	Y	N	Y	----	D	Y	Y
Automatic venetian blinds	A	S	N	Y	----	Y	D	Y	Y
light pipes	P/A	T/S	Y	Y	Y	----	----	----	Y
Prismatic panels	P/A	T/S	Y	Y	Y	----	N	D	D
Laser-cut panels	P	T/S	Y	N	Y	----	Y	N	Y
Light guiding shades	P	S	Y	N	---	Y	Y	Y	D
Anidolic solar blinds	P	S	Y	N	Y	----	D	Y	D
Sun-directing glass	P	T/S	Y	N	Y	----	N	D	Y
Directional selective shading	A	T/S	N	Y	Y	----	Y	D	Y

Abbreviation in table: P: passive systems (do not need sun tracking devices), A: active systems (systems that need sun tracking devices) Y: yes, N: no, D: depends, T: top-lighting systems, S: side-lighting systems, T: testing phase.

## VC.4. Improving distribution of daylight while reducing glare

VC.4.1. Adjusting ceiling properties regarding the existing vision area: Different interior spaces require different façade strategies to improve daylight quality. Spaces with a large vision area mostly are faced with glare problems and in contrast, the spaces with small vision area will require more daylight distribution in interior. Adjusting the ceiling properties is one of the effective strategies to improve daylight quality according to the space.

VC.4.1.1. Sloped down ceilings for rooms with smaller vision areas: Sloping down the ceiling from façade to interior space for rooms with smaller vision area will bring daylight deep into the interior space. Installing an interior light shelf along with vertical shades (east and west facades) and horizontal louvers (south facing facades) will prevent glare and solar heat gains (Aksamija, 2013).

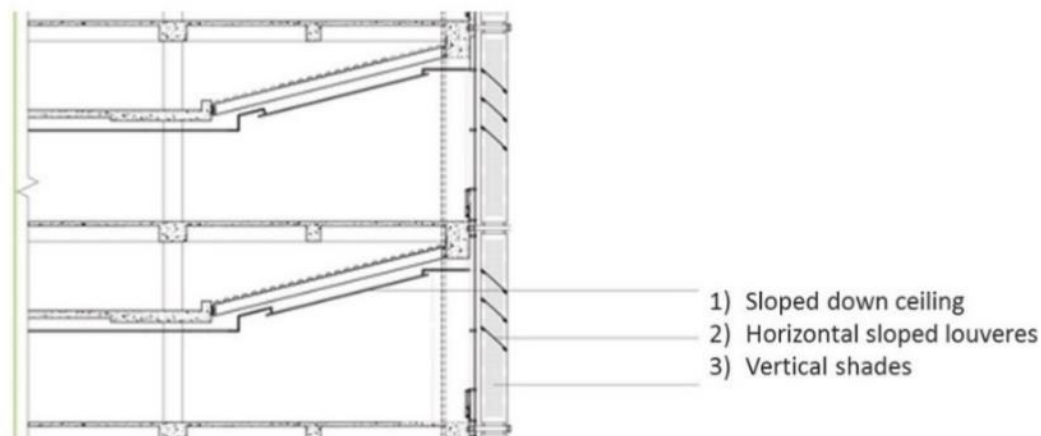
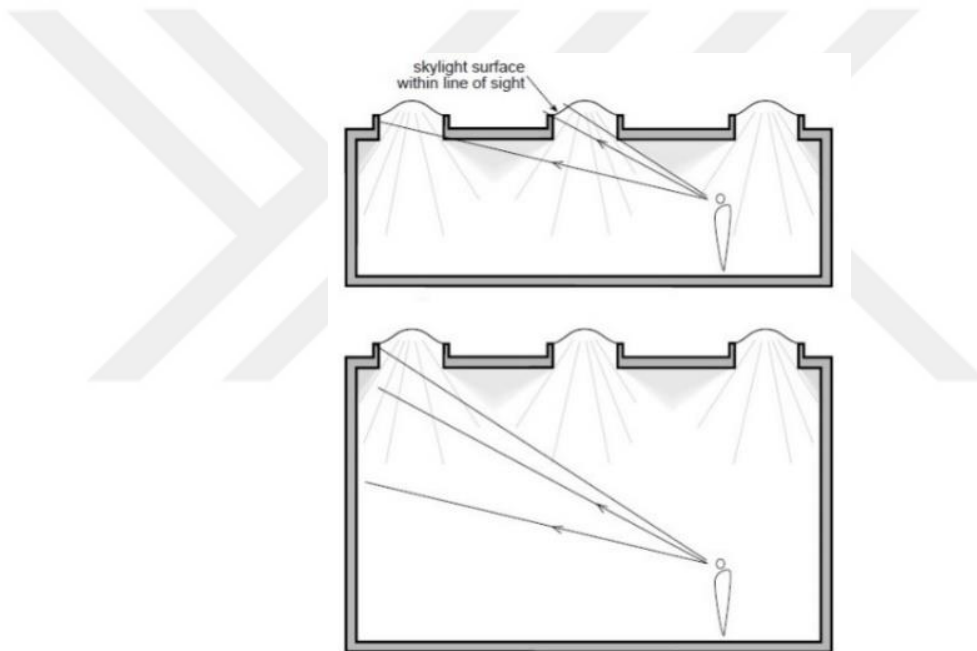

**Figure C.57.** Sloped down ceiling for a laboratory building (Aksamija, 2013).

VC.4.1.2. Sloped up ceilings for rooms with larger vision areas: sloping up the ceiling from façade to the interior space along with a fritted glass at the lower portion of façade will improve daylight distribution and a glare-free space.

***VC.5. Reducing glare in spaces with top-lighting daylight systems***

VC.5.1.1. Avoid skylights in spaces with low ceiling height: Bright light sources in the angle of view and the created contrast between the source and surrounding illumination levels cause glare problem. Top-lightings because of their very bright surface of diffusing skylights are a strong source of glare and visual discomfort for occupants. This problem will be intensified in the case of low-height and large ceilings.



**Figure C.58.** Visual discomfort in high and low ceilings (SkylightingDesignGuidelines, 2014).

VC.5.1.2. providing cut-off angle of 55 for office spaces working with computers: The indicator to evaluate the performance efficiency of skylights in a space is “cut-off” angle. An appropriate cut-off angle in skylight or any artificial lighting fixture does not allow the viewer to see the bright source surface. For office buildings the minimum cut-off angle (from vertical) for lighting fixtures, based on the IESNA recommendation is 55 (Skylighting Design Guidelines, 2014).

VC.5.1.3. Providing both straight and splayed walls around skylight: A wider cut-off angle will allow more daylight distribution, but also more glare discomfort for users. The optimum trade-off between these conflicting needs, as seen in the Figure 116, is providing straight walls around the skylight at upper part of the ceiling and splayed walls at the bottom part of the skylight (Skylighting Design Guidelines, 2014).

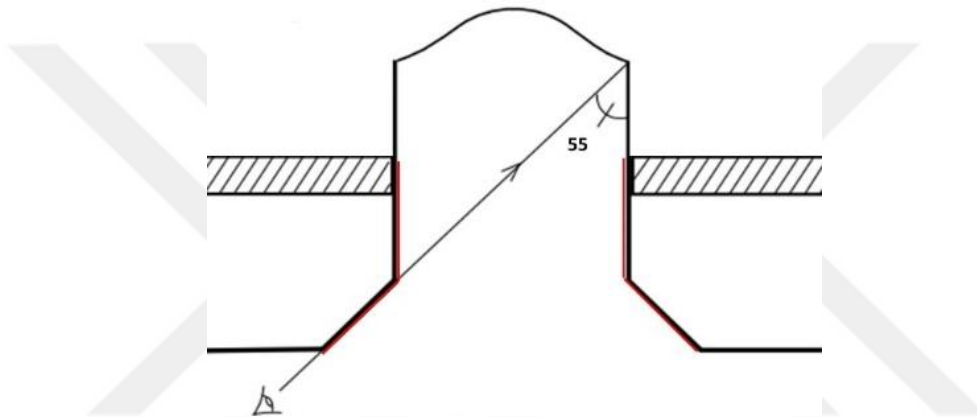

**Figure C.59.** Optimum cut-off angle of skylights for office buildings along with combination of straight and splayed walls in ceiling part (Skylighting Design Guidelines, 2014).

VC.5.2. Integrating horizontal skylights with louvered sun control devices or HOEs: As mentioned in section VC.2.1.1, horizontal skylights because of the transmission of direct sunlight are not energy efficient and can lead to serious glare problems unless the sun control louvers or holographic optical elements are integrated to them.

VC.5.3. Integrating north-facing clerestories with sun-catchers: As mentioned in section VC.1.1.1, the north-facing vertical or sawtooth clerestories are most ideal options to prevent the glare discomfort. However, in these cases, to bring sunlight into the clerestory, suncatcher controls must be installed.



## VC.6. Reducing glare in spaces with side-lighting daylight systems

VC.6.2. Combining translucent glass with transparent vision glass: in order to provide filtered and glare-free natural daylight, translucent glazing can be used and applied partially to the window. In these cases, the above and below part of the clear (transparent) vision glass is combined with translucent glazing, so the eye level remains transparent and allows the users access to outside view (Aksamija, 2013, p.58).

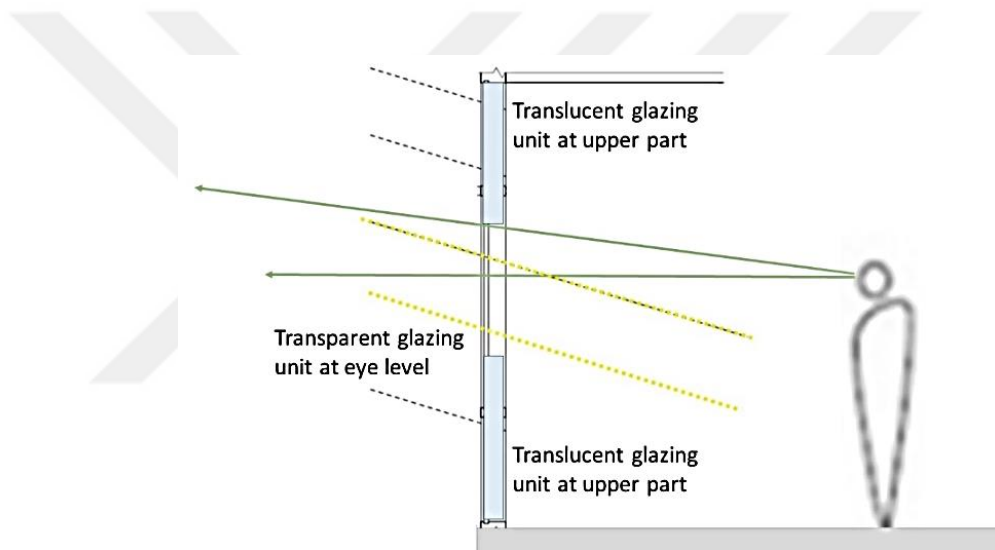

**Figure C.60.** Combining transparent vision glass with translucent glazing (by the author).

VC.6.3.1. Directional selective shading system with HOEs: by means of holographic optical elements embedded in a glass laminate, they are used to redirect or reflect incident light while bringing diffuse light from the distance. They provide natural daylight to the building without glare and distorting occupants' view to outside. This system needs to track the sun path, which makes it an active daylighting system. It can be applied in vertical windows or in skylights.

## VC.7. Providing daylight while reducing glare and SHGC value of glazing units

VC.7.1. Using glazing systems with high visible transmittance and low NIR transmittance: refer to the sections: TC.7.1.1, TC.7.1.2, TC.7.3.1, and TC.7.3.2.

VC.7.2. Using dynamic glazing or dimming systems: Dimming controls will save more energy in climates with highly variable daylight illumination, where the interior daylight illumination level moves between full saturation and partial saturation many times per day. Thermo-chromic dynamic and Photochromic glazing layers are possible options. Thermo-chromic glazing units adjust themselves automatically to the changing climatic conditions. The changing optical and thermal properties of these glazing units provide a tradeoff between the conflicted problems of heat losses and heat gains (Xing, et al., 2011; Jonsson, & Roos, 2010).

The other option is implementing an occupancy-based switchable windows with low-e coating in combination with an electro-chromic layer.

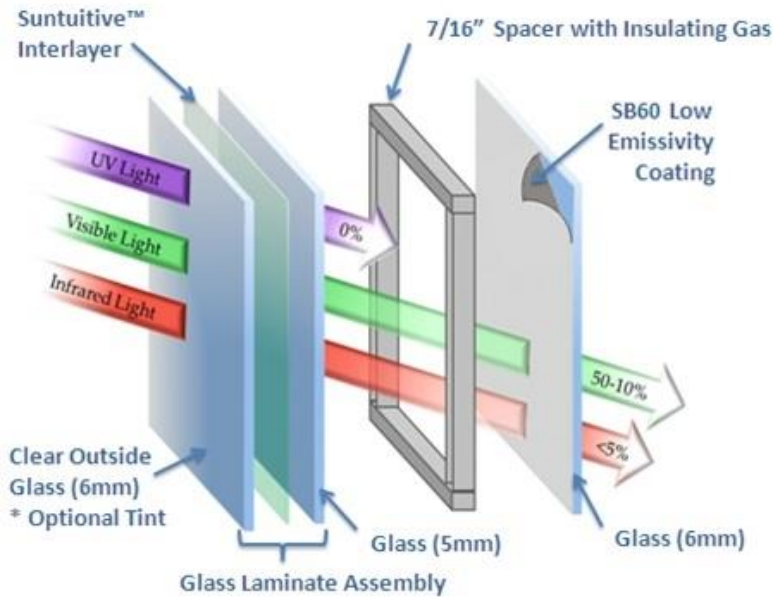

**Figure C.61.** Schematic function of Thermochromic glazing (<http://www.solaripedia.com>).

VC.7.3. Synchronizing the solar transmissivity with sunlight angle: refer to the section TC.7.2.1.

VC.7.4. Using low-emissivity coatings on glazing: as discussed in the section TC.6.2.1, reflective transparent silver mirror like films can admit a glare-free daylight.

VC.7.4.2. Using ceramic fritted or tinted glazing: ceramic fritted coatings on glass are on the basis of a pattern (dots, lines, etc.) to filter the direct solar radiation. A low-e coating can be put on top of the frit (Lee, et al., 2002).



**Figure C.62.** Left: sample of a ceramic-fritted glazing ([www.emporis.com](http://www.emporis.com)), right: sample of a tinted glazing ([www.designboom.com](http://www.designboom.com)).

VC.7.4.3. Using Spectrally selective low-e coatings: refer to the section TC.6.2.2.

VC.7.5. Using proper external shading devices: refer to the section TC.6.4.

VC.7.6. Using light colored open weave fabric interior shading devices: refer to the section TC.6.5.

## **VC.8. Providing view to outside while reducing glare**

VC.8.1. Selecting daylighting systems with adjustable shading ability to provide outside view: refer to the section VC.2.2.

VC.8.2. Using dynamic glazing: Electrochromic glass (EG) is a sample of dynamic glass that can change its optical properties during the day without using electrical loads. In a recent study by Malekafzali et al., (2017), the simulation results revealed that electro-chromic glass with appropriate zoning can provide a glare-free daylight more effectively while the view to outside is maintained. They claim that the EGs are more effective than fritted glass units.

VC.8.3. Using perforated blind systems: these solar filters can be opaque, translucent, or transparent materials such as, metal sheets and fritted glasses. Perforated blind systems provide glare-free daylight, while allowing a partial view (Lee et al., 2002).

### **Daylight and visual comfort in double-glazed façade systems**

#### **VC.9. Providing daylight while reducing glare and SHGC value of glazing units**

VC.9.1. Adding motorized louvers inside the outer façade: the motorized louvers or shadings can be adjusted to optimize the trade-off between daylighting requirements and cooling demands during summer. By using occupancy sensors it is possible to determine whether the adjacent room is occupied or not (Harvey, 2012, p.92; Vassigh & Chandler, 2012). Also refer to the section TC.19.1.

By using double-skin facades, the transparency, outside view, and daylight distribution in the interior can be increased. As regards the fact that increased glazing area will cause serious glare problems, especially, in open plan office, a protective second façade layer along with proper shading devices on outer façade, will be effective in solving the problem (Hendriksen et al.).



**Figure C.63.** Double-skin façade with perforated metal louvers. Left: open louvers in early morning hours, right: closed louvers to block direct solar radiation in west façade (Vassigh & Chandler, 2012, p.88).

### **AC.1. Increasing sound insulation through the opaque parts of the façade**

The sound resistance properties of cladding walls is mainly related to its mass. One the effective actions to improve the acoustical performance of external cladding walls is creating discontinuity of materials and, disrupting the sound path, and thus, blocking sound transmission.

AC.1.1. Increasing the mass of the cladding materials: the more massive claddings or panels will have lower sound transmission losses (Aksamija, 2013).

AC.1.2. Using different layers of cladding materials: to disrupt the sound path and blocking its transfer, creating discontinuity of materials by using different layers of cladding materials within enclosure façade panels is an ideal option.

AC.1.3. Providing acoustic breaks in façade layer: similar to the thermal breaks, as discussed in the section TC.12.5, acoustic breaks are essential to prevent sound transmission through the walls.

AC.1.4. Providing air spaces between adjacent walls: air will be act as an insulation layer to hamper the sound transmission between adjacent walls

AC.1.5. Using acoustic insulations: typically, a parallel improvement of both thermal and acoustical performance of the façade systems is possible by using appropriate insulation materials either directly under the external assembly layer or within external cavity walls (Paris-Newton et al., 2015)

AC.1.5.1. Using silica aerogels, closed cell foam, etc.: closed cell foam boards have a hard surface, which makes them impossible to be used as insulation materials in cavity wall assemblies. However, they are good options to insulate external walls. The greater density of the foam will result higher soundproofing ability. Silica aerogels are useful in terms of both thermal and acoustical insulation materials (Shekar & Krarti, 2017). In a recent research by Feng et al. (2016), silica-cellulose aerogels due to their flexibility show a better performance in terms of acoustical properties compared to cellulose aerogels.

AC.1.5.2. Adding insulation within air spaces: filling the created air spaces between walls and assemblies with insulation materials for both purposes of thermal and acoustical improvements is recommended.

AC.1.6. Sealing air leaks in the wall assembly: sound insulation can also affected by wrong detail design or fitting flashings.

## **AC.2. Increasing sound absorption through cladding panels**

If the external noise problem is due to reverberation or resonance, then, the sound reflection must be reduced by using non-reflective materials such as liner sheets, in addition to the insulation layer.

AC.2.1. Using non-reflective materials, like liner sheets: in preferring perforated liner sheets, a dense acoustic mineral wool layer is often included to absorb sound waves.

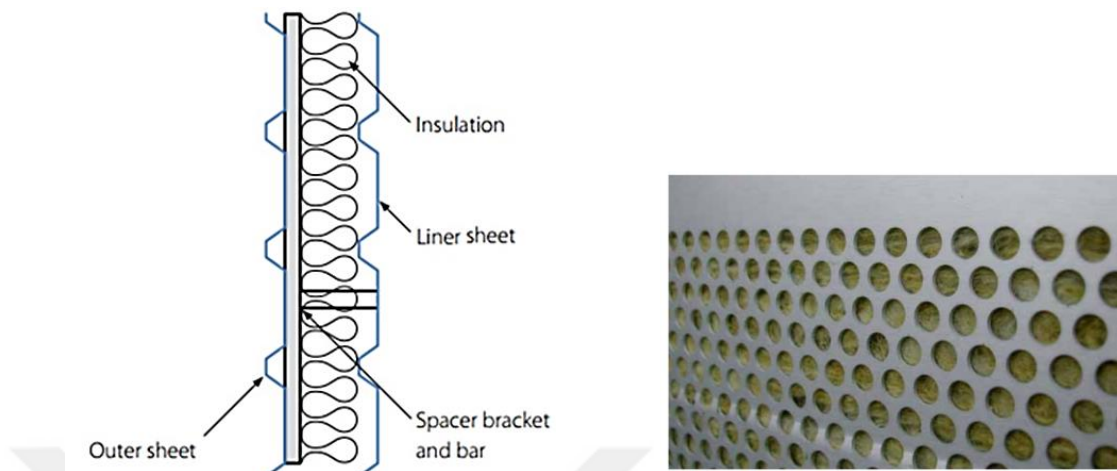

**Figure C.64.** Left: cross section of the position of non-reflective liner sheet layer. Right: example of a perforated liner sheets (Tata Steel, 2012).

### **AC.3. Reducing noise impacts of rain on cladding panels**

The complete elimination of the noise from these sources is impossible. However, by adding a flexible layer directly below the external skin can be effective. Using insulated façade systems, sandwich construction, and thermal breaks, which discussed in previous sections can also be effective.

### **AC.4. Reducing sound transmission through the glazing area**

AC.4.1. Increasing the thickness of glass: in thicker glass, will increase the mass of the sound path. This action can be more effective if different thicknesses of glass be incorporated in an insulated glass unit (Aksamija, 2013, p.56).

AC.4.2. Incorporating noise-reducing interlayer: acoustic interlayers are laminated between glass panes. Sound insulating PVB interlayers are good options for this action.

AC.4.2.1. Using PVB laminated glass: Incorporating a noise-reducing interlayer, typically a thin polyvinyl butral (PVB) between glass panes can, substantially, improve the acoustic performance of the glazing unit (Libby, 2001).

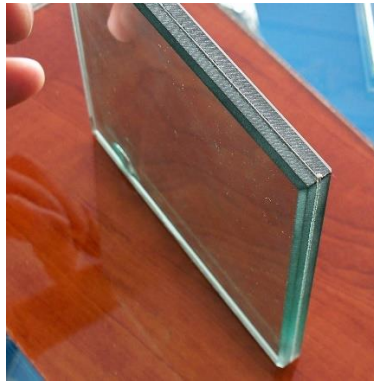

**Figure C.65.** Example of a PVB laminated glass unit (smartglassline.com).

AC.4.3. Using standard air-filled insulating glass units: IG units comprised of multi-pane glass units that are sealed in the edge-of-glass area. The panes are held together structurally along their perimeters by various types of edge seal systems. To improve the overall insulating value of an IG unit, the inter-pane space is mainly filled with an inert gas, such as argon or krypton. The key function of the edge seal is to keep the glass panes separated at equal distances while providing a barrier to prevent infiltration of water vapor or exfiltration of the gas (or air) fill between the panes.

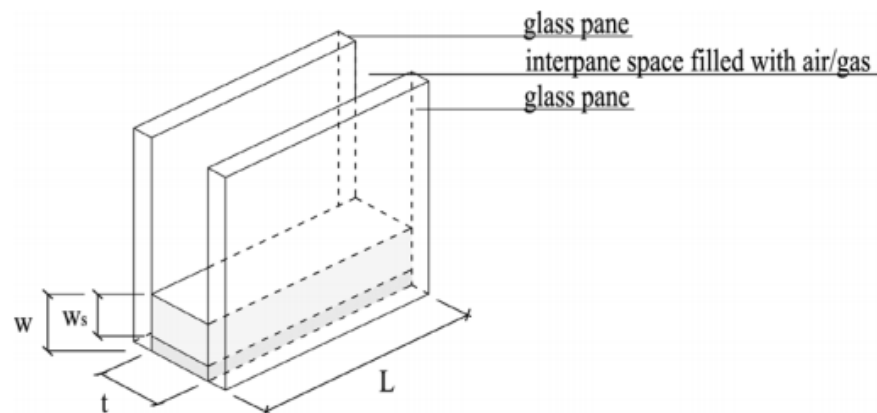

**Figure C.66.** Schematic geometry of a double-pane IG unit with edge seal thickness ( $t$ ), width ( $w$ ), spacer bar width ( $ws$ ), and length ( $L$ ) (Van Den Bergh et al., 2013).



AC.4.4. Laminated + insulated glazing: laminated glass by creating the discontinuity of materials that dampens the sound waves, will improve the acoustic performance of single-glazed windows. Although a standard air-filled insulating glass units perform better than single-glazed ones (Aksamija, 2013, p.65).

AC.4.4.1. One lite or two lites of 1/4 inch laminated glass: using laminated glass for one or both lites in a 1-inch thick, air-filled IG unit will improve its acoustic performance.

AC.4.5. Using triple-glazed insulating units: triple-glazed units comprised of a glass middle lite or a laminated membrane lite have a better acoustic performance rather than single- and double-glazed units (Aksamija, 2013, p.65).

AC.4.5.1. Using insulated unit: constructed with a "soft" separation between the lite of glass

AC.4.5.2. Using an assembly consisting of: a standard 1-inch insulating unit, a 2-inch air space, and an inner lite of 1/4-inch glass will have an OITC of 32-35 and an STC of 42-44

AC.4.6. Using acoustic breaks: like thermal breaks, using pressure bars in curtain wall system and placement of gaskets between pressure bars and mullions will act as acoustic breaks for the façade.

#### **Acoustic comfort retrofit actions for double-skin façade systems**

#### **AC.5. Reducing external sound transmissions**

AC.5.1. Adding a second layer of glass to the existing conventional façade reduces sound transmission, especially, in loud locations (Lee et al., 2002). In the literature, one of the main reasons to prefer the double-skin facades is their sound insulation capability. By implementing a second outer skin to the existing skin the noise levels derived from both internal noise pollution and external noise pollution can be reduced.

However, the acoustical efficiency of a double-glazed façade generally depends on the type and number of openings.

AC.5.1.1. Box window double-skin facades: If outside noise is a major problem for an office building, the box window type of double-skin facades can be an alternative. The fewer openings at the outer layer is one of the features of this type, which makes it acoustically isolated from the outside noise (Harvey, 2012).

AC.5.1.2. Multi-stories façades: these types are divided neither horizontally nor vertically, but they are composed of fewer openings that makes them great alternatives for buildings, which are suffering from external noises, however, like corridor types may require attention regarding the sound transmissions from one office to another. In other words, if the internal noise levels are high these types are not appropriate options (Harvey, 2012, p.92). The other disadvantage of these types is that natural ventilation actions cannot be considered (Poirazis, 2006).