

METAHEURISTIC BASED BACKCALCULATION OF ROCK MASS  
PARAMETERS AROUND TUNNELS

A THESIS SUBMITTED TO  
THE GRADUATE SCHOOL OF NATURAL AND APPLIED SCIENCES  
OF  
MIDDLE EAST TECHNICAL UNIVERSITY

BY

GÖRKEM GEDİK

IN PARTIAL FULFILLMENT OF THE REQUIREMENTS  
FOR  
THE DEGREE OF MASTER OF SCIENCE  
IN  
CIVIL ENGINEERING

MAY 2018



Approval of the thesis:

**METAHEURISTIC BASED BACKCALCULATION OF ROCK MASS  
PARAMETERS AROUND TUNNELS**

submitted by **GÖRKEM GEDİK** in partial fulfillment of the requirements for the degree of **Master of Science in Civil Engineering Department, Middle East Technical University** by,

Prof. Dr. Halil Kalıpçılar  
Dean, Graduate School of **Natural and Applied Sciences**

Prof. Dr. İsmail Özgür Yaman  
Head of Department, **Civil Engineering Dept., METU**

Asst. Prof. Dr. Onur Pekcan  
Supervisor, **Civil Engineering Dept., METU**

**Examining Committee Members:**

Prof. Dr. Sadık Bakır  
Civil Engineering Dept., METU

Asst. Prof. Dr. Onur Pekcan  
Civil Engineering Dept., METU

Prof. Dr. Oğuzhan Hasaebi  
Civil Engineering Dept., METU

Asst. Prof. Dr. Nabi Kartal Toker  
Civil Engineering Dept., METU

Asst. Prof. Dr. Gence Gen elik  
Civil Engineering Dept., ankaya University

**Date:** 03.05.2018



**I hereby declare that all information in this document has been obtained and presented in accordance with academic rules and ethical conduct. I also declare that, as required by these rules and conduct, I have fully cited and referenced all material and results that are not original to this work.**

Name, Last name: GÖRKEM GEDİK

Signature :

## **ABSTRACT**

### **METAHEURISTIC BASED BACKCALCULATION OF ROCK MASS PARAMETERS AROUND TUNNELS**

Gedik, Görkem

M.S., Department of Civil Engineering

Supervisor: Asst. Prof. Dr. Onur Pekcan

May 2018, 83 Pages

Due to uncertainties in the ground conditions and the complexity of soil-structure interactions, the determination of accurate ground parameters, which are not only used in tunnel construction but in the design of all underground structures, have a great significance in having structures that are cost-efficient. Backcalculation methods which rely not only on laboratory and field tests but also on field monitoring and field data provide real structure conditions and therefore it is gaining popularity in geotechnical engineering. In this sense, when compared to the conventional methods, backcalculation methods are able to attain accurate geomechanical parameters of materials surrounding the tunnels with the help of deformation data that is observed in tunnel constructions. Tunnels are especially significant as they compose a great part of all underground structures. Obtaining these parameters in a fast manner is important in terms of the calibration of the parameters that are gathered during the construction.

In this study, a finite element based backcalculation is developed by using Simulated Annealing and Particle Swarm Optimization methods. On the developed platform,

the metaheuristic based algorithms, which are embedded into the back analysis platform as an intelligent parameter selection method which provide data for the finite element method. The response of the tunnel structure is obtained via two-dimensional finite element analyses. The developed back analysis platform is tested by using the deformation data which is gathered from the T26 tunnel construction within the scope of Ankara-Istanbul Highspeed railway project. The tunnel is opened with the New Austrian Tunnel Method and therefore, not only the rock mass parameters of the graphite-schist surrounding the tunnel but also the in-situ stress around the tunnel are backcalculated. Verifications is done by comparing the ground parameters that are gathered through the calculations with the laboratory results. It is observed that the success of the results is due to the optimization algorithm that has been used and the sensitivity of the measured values. The documented parameters can be used to better understand the rock mass behavior and to create more realistic models for the underground structures that have the same rock mass conditions. This study enabled to obtain the correct parameters in a fast and accurate manner by using optimization algorithms and finite element method for tunnels where backcalculation methods are used.

**Keywords:** Tunnel, Backcalculation, Optimization, Finite Element Method, Particle Swarm Optimization, Simulated Annealing

## ÖZ

### TÜNEL ÇEVRESİNDEKİ KAYA PARAMETRELERİNİN METASEZGİSEL TABANLI GERİ HESAPLANMASI

Gedik, Görkem

Yüksek Lisans, İnşaat Mühendisliği Bölümü

Tez Yöneticisi: Dr. Öğr. Üyesi Onur Pekcan

Mayıs 2018, 83 Sayfa

Zemin koşullarındaki belirsizlik ve zemin yapı etkileşimlerinin kompleks etkileri nedeniyle, başta tüneller olmak üzere hemen her yer altı yapısının tasarımında kullanılan zemin parametrelerinin doğru belirlenmesi, yapılacak olan imalatların ekonomik olması açısından yüksek önem arz etmektedir. Laboratuvar ya da arazi testlerine ek olarak arazi gözlem ve verilerine dayanan ve bu nedenle yapının imalat koşullarını da daha gerçekçi olarak temsil eden geri hesaplama yöntemleri, Geoteknik Mühendisliği'nde popülerlik kazanmaktadır. Bu bağlamda; geri hesaplama yöntemleri kullanılarak, alt yapı yatırımlarının önemli bir kısmını oluşturan tünellerin inşaatı sırasında gözlemlenen deformasyon verileri sayesinde, tüneller çevresindeki birimlere ait geomekanik parametreler, konvansiyonel yöntemlere göre çok daha gerçekçi şekilde elde edilebilmektedir. Bu parametrelerin hızlı bir şekilde elde edilmesi, imalatların devamı sırasında elde edilen parametrelerin kalibrasyonu açısından da önem arz etmektedir.

Bu çalışmada, benzetimsel tavlama ve sürü optimizasyonu yöntemleri kullanılarak sonlu elemanlara dayanan bir geri hesaplama yöntemi geliştirilmiştir. Geliştirilen

platformda, metasezgisel optimizasyon algoritmaları, sonlu elemanlar yöntemine veri sağlayan akıllı bir parametre seçim yöntemi olarak geri hesaplama yönteminin içine gömülmüştür. Tünel yapılarının tepkileri ise 2 boyutlu sonlu elemanlar analizleri ile elde edilmiştir. Geliştirilen geri hesaplama platformu, Ankara-İstanbul Hızlı Tren Projesi kapsamında imal edilen ve Yeni Avusturya Tünel Metodu ile açılan T26 Tüneli inşası sırasında ölçülen deformasyon verileri kullanılarak test edilmiş, ve böylelikle sadece tünel çevresindeki grafit-şist birimlerine ait kaya kütle parametreleri değil ve aynı zamanda tünel çevresinde var olan gerilmelerin geri hesaplanması da sağlanmıştır. Elde edilen sonuçların başarısının, ölçüm verilerinin hassasiyetine ve kullanılan optimizasyon algoritmasının seçimine bağlı olduğu gözlenmiştir. Raporlanan parametreler aynı kaya kütle yapısına sahip birimlerde açılacak olan yeni yer altı yapılarının daha gerçekçi modellenmesinde ve kaya kütle davranışının daha doğru anlaşılmasında kullanılabilir. Bu çalışma, tüneller için kullanılan geri hesaplama yöntemlerinde, metasezgisel optimizasyon algoritmaları ve sonlu elemanlar metodu kullanılarak doğru parametrelerin daha hızlı ve daha yakın şekilde elde edilmesine olanak kılmıştır.

Anahtar Kelimeler: Tünel, Geri Hesaplama, Optimizasyon, Parçacık Sürü Optimizasyonu, Benzetimsel Tavlama





*Dedicated to my family...*

## ACKNOWLEDGEMENTS

Firstly, I would like to express my deepest gratitude to my supervisor Asst. Prof. Dr. Onur Pekcan for his guidance advice and friendship throughout the research. His helps and patience always moved me one step further either in academic or personal life.

Secondly, I would like to thank all members of the thesis examining committee: Prof. Sadik Bakır, Prof. Oğuzhan Hasaebi, Dr. Nabi Kartal Toker and Dr. Gence Gen, for accepting to be a member in my thesis defense and spending their valuable time for reviewing my thesis and providing feedback.

I would like to thank employees of State Railways of Turkish Republic for their technical supports.

I would also like to thank my colleagues and dear friends Gön Berk Güneş, Batu Türksönmez and Berk Bora akır for their technical discussions and help in many instances during my thesis journey.

I would like to specially thank Merve Öksüzöğlü for her invaluable support, courage and endless patience.

Finally, I must express my profound gratitude to my family for providing me with unconditional support and continuous encouragement throughout my years of studying. Everything I accomplish including this work would not have been possible without them.



## TABLE OF CONTENTS

ABSTRACT.....	v
ÖZ.....	vii
ACKNOWLEDGMENTS.....	x
TABLE OF CONTENTS.....	xi
LIST OF TABLES .....	xv
LIST OF FIGURES.....	xvi
LIST OF ABBREVIATIONS .....	xviii
CHAPTERS	
1. INTRODUCTION.....	1
1.1. Background .....	1
1.2. Research Objective.....	4
1.3. Scope .....	5
1.4. Thesis Outline .....	7
2. LITERATURE REVIEW.....	9
2.1. Tunnel Monitoring Techniques .....	9
2.1.1. Convergence Measurements.....	12
2.1.2. Optical Measurements.....	14
2.1.3. Extensometers .....	15
2.2. Numerical Methods for Tunnels.....	16
2.2.1. Finite Element Method.....	17
2.2.2. Finite Difference Method.....	18

2.2.3. Boundary Element Method .....	20
2.3. Back Analysis in Geotechnical Engineering .....	22
2.4. Optimization Techniques .....	25
2.4.1. Gradient – Based Methods .....	25
2.4.2. Metaheuristic Search Methods.....	25
2.4.2.1. Simulated Annealing .....	26
2.4.2.2. Particle Swarm Optimization .....	27
2.4.3. Enumerative Search Methods .....	28
3. BACK ANALYSIS PLATFORM.....	31
3.1. General .....	31
3.2. Deformation Based Backcalculation Algorithm for Tunnels.....	31
3.2.1. Finite Element Modeling Setup .....	33
3.2.1. Metaheuristics Based Optimization .....	36
3.2.1.1. Simulated Annealing Algorithm.....	36
3.2.1.2. Particle Swarm Optimization Algorithm.....	40
4. CASE STUDY: .....	43
4.1. Project Information .....	43
4.1.1. Geology of the Tunnel’s Project Area .....	45
4.1.2. Construction and Monitoring of T26 Tunnel.....	46
4.2. Finite Element Model .....	49
4.3. Metaheuristics Based Parameter Calculation .....	56
4.3.1. Particle Swarm Optimization Performance.....	57
4.3.2. Simulated Annealing Performance .....	58
4.4. Forward Calculation with Optimized Parameters.....	61

4.5. Results & Discussion .....	64
5. CONCLUSION .....	67
5.1. Summary.....	67
5.2. Findings of the Study .....	68
5.3. Future Work .....	70
REFERENCES.....	73
APPENDICES.....	79
A. CONSTRUCTION DETAILS .....	79
B. DEFORMATION MEASUREMENTS .....	79

## LIST OF TABLES

### TABLES

Table 1 Deformation Measurements at Reading Points Km:216+524 .....	49
Table 2 Parameter Constraints .....	56
Table 3 Initial Parameters .....	56
Table 4 Observed Parameters - PSO.....	58
Table 5 Boundary Constraints.....	59
Table 6 Perturbation Values.....	59
Table 7 Observed Parameters - SA .....	61
Table 8 Optimum Parameters .....	62
Table 9 Measured, Backcalculated, Pre-estimated Deformations .....	62
Table 10 Backcalculated Parameters and Pre-estimated Parameters.....	63
Table 11 Deformation Measurements.....	82

## LIST OF FIGURES

### FIGURES

Figure 1 Tunnel Monitoring .....	3
Figure 2 Monitoring Techniques (Lunardi, 2008) .....	11
Figure 3 Convergence Measurement with Distometer (Lunardi, 2008) .....	13
Figure 4 Monitoring Target with Protection Pipe .....	14
Figure 5 Extensometer Reading (Lunardi, 2008).....	15
Figure 6 Representation of a tunnel by FEM (Gnilsen, 1989) .....	17
Figure 7 Back Analysis Platform Flowchart .....	32
Figure 8 Tunnel Model Geometry and Generated Mesh.....	34
Figure 9 Simulated Annealing Flow Chart .....	39
Figure 10 Particle Swarm Optimization Flowchart.....	41
Figure 11 The location of T26 Tunnel .....	45
Figure 12 Tunnel Excavation Sequence .....	47
Figure 13 Monitoring Points .....	48
Figure 14 Deformation Data .....	48
Figure 15 Model Geometry and Generated Mesh (PLAXIS 2D) .....	50
Figure 16 Initial Phase.....	51
Figure 17 The Second Phase .....	52
Figure 18 The Third Phase .....	52
Figure 19 The Fourth Phase .....	53
Figure 20 The Fifth Phase .....	53
Figure 21 The Sixth Phase .....	54
Figure 22 Final Phase.....	54
Figure 23 Locations of the Monitoring Points Around the Tunnel.....	55
Figure 24 Gbest Fitness Value vs Number Of Iteration.....	57



Figure 25 Fitness Value vs Number of Analysis .....	60
Figure 26 Best Feasible Design.....	61
Figure 27 Deformation Shadings Around the Tunnel.....	62
Figure 28 Construction Details A.....	79
Figure 29 Construction Details B.....	80
Figure 30 Deformation vs Date Graph.....	83



## LIST OF ABBREVIATIONS

ANN	:	Artificial Neural Networks
BEM	:	Boundary Element Method
BeEM	:	Beam Element Method
DE	:	Differential Evolution
DEM	:	Discrete Element Method
FE	:	Finite Element
FEM	:	Finite Element Method
GA	:	Genetic Algorithm
GSI	:	Geological Strength Index
HA	:	Hybrid Algorithm
HS	:	Harmony Search
NATM	:	New Australian Tunneling Method
NN	:	Neural Networks
PSO	:	Particle Swarm Optimization
SA	:	Simulated Annealing
SVMs	:	Support Vector Machines
TCDD	:	State Railways of Turkish Republic
UCS	:	Uniaxial Compression Strength

# CHAPTER 1

## INTRODUCTION

### 1.1. Background

In the last three decades, due to the quick growth of population especially in the city centers, the need for having underground structures has increased remarkably. This demand specifically results in having more tunnels, to be designed properly considering the field conditions, which leads to having improved designs and utilization and innovation of more advanced construction technologies.

There are many examples of widely known tunnels in the world such as Seikan Tunnel (1988) and Gotthard Base Tunnel (2016) connecting city centers, providing fast, comfortable, and safe transportation. Although tunnels are quite preferable providing many advantages considering the induced demand due to population, they are one of the most expensive construction types compared to other engineering structures. This brings up a need for their optimal design, which aims to have the reduction of high costs.

The lack of soil data and its corresponding parameter information leads designers to have a tendency to be on the safe side during both design and construction stages of tunnels and hence increases their construction costs. Especially at the design stages of tunnels, due to having higher uncertainties in underground, finding out the relevant soil or rock mass properties to be used is a major problem, which needs to be solved by appropriate engineering approaches. In this sense, structural deformations can play a crucial role as they are one of the key indicators of

engineering structures' performance, which can also specify the properties of the materials in the structure.

In the literature, there are various mechanisms to combine the deformations obtained from the field and the ones obtained at the design stage of an engineering structure. For example, when excavations are considered, numerical modeling can describe the soil behavior during the construction and examine the performance of a highly complex excavation by comparing the field measurements with the calculated displacements, and predict future deformations (Finno and Harahap 1991; Hashash and Whittle 1996). Accurate prediction of deformations of deep excavation using numerical simulation depends greatly on the selection of constitutive models and the determination of soil parameters (Wang et al. 2009; Nikolinakou et al. 2011). Due to the uncertainties of sample disturbance and measurement errors in field-measured parameters, numerical model may deviate from reality and mislead the designer.

The successful use of numerical simulations in geotechnical engineering is highly dependent on the constitutive model to represent the soil behavior. When the behavior of the rock mass around the tunnel becomes uncertain, the inverse calculation of the material properties becomes important. Since, the mechanics of the excavation fully affects the behavior of the surrounding rock mass around the tunnel; it is efficient to select critical parameters based on field measurements. The most critical parameters that highly affect the behavior of the rock mass are Young Modulus, geological strength index (GSI), unconfined compression strength (UCS) and the initial stress ratio ( $K_0$ ). These parameters, which are related to the observed response of the structure, can be used in the process of adapting the support system and excavation method to real geomechanical characteristics.

Backcalculation procedure uses the information of the field measurements with the numerical models to calibrate input parameters fitting with a defined tolerance. Therefore an iterative model is needed to reach the true set of parameters. However,

the behavior of underground structures in soft soils or jointed rock masses is generally non-linear. This non-linearity imposes a great difficulty to most back-analysis procedures, especially when the number of unknowns increases. Therefore, it is wise to back analyze the problems by using optimization procedures to reach the exact set of parameters from the field measurements.

In this study, a back analysis platform is developed implementing two widely accepted optimization algorithms combined with the finite element method to backcalculate the rock mass parameters to be used for both design and validation purposes. This platform is then used in a case study for the back analysis of geomechanical parameters of the rock mass and soils surrounding the Ankara-İstanbul Railway tunnel located in Bilecik province of Turkey.



Figure 1 Tunnel Monitoring

## 1.2. Research Objective

Monitoring plays a crucial role during tunnel construction. As the regulations enforce, all tunnel constructions should have a monitoring system, which allow the contractor to check whether the deformations are stabilized within tolerable limits and enable designers to be able to backcalculate the real set of parameters for the surrounding soil or rock medium. In this study, we aim to generate a backcalculation platform to obtain the rock mass parameters surrounding the tunnels. Inversely calculated data may help to reduce the investigation costs and increase the information of behavior of rock mass around a tunnel. Moreover, for critical tunnel projects, a guide tunnel is constructed before the main tunnel construction in order to investigate the rock mass surrounding the tunnel. Thanks to new measurement techniques, displacement data from guide tunnels can easily be used for backcalculation of the real set of parameters.

It was observed from the previous studies that, backcalculation analyses are most commonly used for linear problems; however, due to the inelasticity of the soil problems, backcalculation is difficult to predict the initial values from the soil response. By means of metaheuristic optimization techniques such as Particle Swarm Optimization and Simulated Annealing, inverse analysis of parameters is faster and more precise. In order to overcome the optimization problem, the fitness function is defined as the difference between the field-measured values and the calculated values from the numerical model of a tunnel. With the help of measured values, the excavation and support information; real case study is performed in the numerical model. At the end of the analyses, a set of parameters are calculated as the predicted real parameters.

The primary objective of the thesis is to obtain the set of parameters which fits the monitored data gathered from tunnel construction monitoring and the influence of the optimization algorithm in the process. In this sense, it is intended to contribute to the

field by deepening the analysis on the applicability of different types of optimization algorithms. This research also aims to enlighten the future studies and new underground structures to make an optimal design with the real set of parameters.

### **1.3. Scope**

Development of a back analysis platform requires the solution of an inverse problem, which is generally ill-posed due to its nature. This generally requires the use of solid numerical modelling tools, an effective optimization algorithm as well as properly working deformation sensors. Since the subject is wide spread, during the development of the back analysis platform, various limitations need to be posed to the above concepts.

In the scope of this study, the finite element method is used to numerically analyze tunnel structures. A two-dimensional model is preferred for this purpose. This approach may deviate from the actual three-dimensional problem to some extent. In order to simulate three-dimensional effects, relaxation factors are used in the modeling process. Although three-dimensional modeling and back analyzing seems practically possible and have better performance in terms of reflecting the real case scenarios, it requires an excessive amount of execution time in the back analysis process. In short, to keep the balance between reliability and efficiency, a 2D model is preferred and possible 3D effects are ignored in the scope of this thesis.

Within modeling of the tunnel structure, the geomechanical parameters considered in the back analysis process are the deformability modulus, uniaxial compressive strength and geological strength index (GSI) and initial stress ratio ( $K_0$ ) as these parameters have with the highest influence in the behavior of the rock mass and also the ones with largest uncertainty degree. There may be other parameters affecting the behavior of tunnels since there may be large deviations in the measured deflections, however, they are not considered during modelling process.

The field measurements used in this study are obtained through both a total station device and optical elements. Other recently introduced measurement techniques including laser scanners or measurements based on drones specifically developed for tunnels are kept out of this study. Although these newly introduced techniques also provide deflection measurements, they can be considered for future works as their back processing tools may be fundamentally different than the one developed in this study.

During the matching process of deformations obtained from both the finite element method and field, it is necessary to implement a global optimization algorithm to cope with non-linearity of the objective function induced due to the material modelling and provide a reliable estimate for the solution. Within the scope of this study, two-dimensional modeling sequence is completed with two well-known metaheuristic optimization algorithms Particle Swarm Optimization and Simulated Annealing. For the optimization stage, various recently introduced such as Differential Evolution, modified versions of Simulated Annealing or Particle Swarm Optimization or other well-performing metaheuristics are not considered. In addition, conventional gradient based methods that involve first or higher order derivatives of the objective function and constraints depending on the number of variables or the enumerative methods are also kept out of the scope although these methods are generally mathematics-based and fast, they may suffer from trapping in a local minimum point according to the initial values.

Finally, the performance of developed back analysis platform is measured only through a case study using a tunnel constructed in Ankara-Istanbul high-speed railway project, as the data from this project are available without any constraints. More project data can easily be integrated into the platform to increase its reliability level.



#### **1.4. Thesis Outline**

This thesis starts with the introductory chapter, which includes the statement of the research problem, the objectives of the research and its scope. The rest is organized as follows: Chapter 2 provides the literature work related to tunnel monitoring techniques, backcalculation procedures and optimization algorithms. Chapter 3 introduces the back analysis platform together with the metaheuristic optimization algorithms and their working scheme. Chapter 4 presents the application of developed platform on a tunnel case study obtained from Ankara-Istanbul high-speed railway, detailing the comparison of deformations obtained from numerical models and field surveys, and providing insight with the rock mass parameters obtained through comparison with the laboratory experiments. Chapter 5 concludes the thesis with the findings of the study, highlights conclusions, and provides recommendations for the future work.



## CHAPTER 2

### LITERATURE REVIEW

An extensive literature review of tunnel monitoring, numerical and optimization methods will be covered in this chapter.

#### **2.1. Tunnel Monitoring Techniques**

For underground structures; especially tunnels, predicting the rock mass behavior is a challenge during design and construction. Even though it is possible to know the general geological situation, changes in rock mass stiffness or structure ahead of the tunnel face and the stresses that highly influence the vicinity of the tunnel, deformations cannot always be detected with great certainty.

The changes in strength or deformability in the host ground where the tunnel is being built tend to cause many problems. Safe and cost-effective tunneling under challenging circumstances requires constant adaptation of excavation and support design. Hence, a very significant role is given to instrumentation and monitoring in order to verify design assumptions and calibrate numerical models for the construction of the tunnel. Moreover, in case of a scenario where the tunnel is faced with the danger of collapsing or when the initial support or lining is not performing as desired monitoring serves as an alert. Particularly, deformation monitoring acts as the main factor in performance control and cost-effectiveness of underground excavation. In recent years, monitoring the deformation around tunnels has become an essential regulation in assessing the stability and assessing the tolerable risk of rock mass response. (Kontogianni and Stiros, 2003)

Monitoring of tunnels especially constructed with the New Australian Tunneling Method (NATM) is a very important working procedure. Since, there is a great number of ambiguous factors not only for construction methods but also for the rock mass around the tunnel. According to Haibo Li (2016), monitoring measurements provides a safeguard for tunnels on an experimental basis. Moreover, for the construction pattern, the deformations around the tunnels should reach equilibrium, so that the secondary linings can be constructed. There are many monitoring techniques for underground constructions, as it can be seen from the Figure 2.



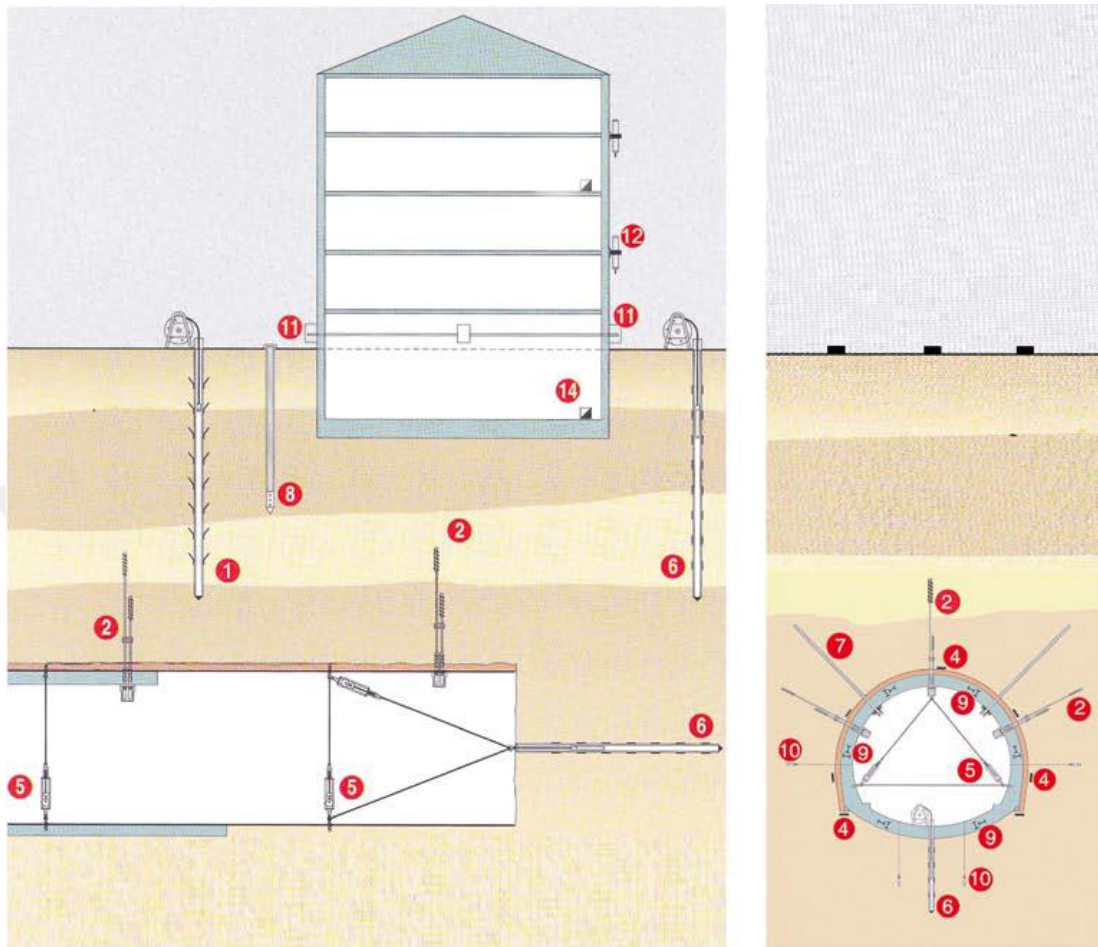

- |   |   |
|---|---|
| <p><b>1 Magnetic settlement meters</b><br/><i>Ground settlement</i></p> <p><b>2 Multipoint extensometers</b><br/><i>Deformation / plasticitation of the ground</i></p> <p><b>3 Smach accelerograph</b><br/><i>Vibrations during excavation</i></p> <p><b>4 Pressure cells</b><br/><i>Pressure on the ground-lining interface</i></p> <p><b>5 Tape distometers</b><br/><i>Convergence in the tunnel</i></p> <p><b>6 Incremental extensometers, inclinometers</b><br/><i>Ground extrusion and deformation</i></p> | <p><b>7 Anchor load cells</b><br/><i>Rock bolts and anchors pull</i></p> <p><b>8 Piezometric-settlement column</b><br/><i>Piezometry and settlement</i></p> <p><b>9 Strain gauges</b><br/><i>Lining stress and strain</i></p> <p><b>10 Electrical piezometers</b><br/><i>To control neutral pressures</i></p> <p><b>11 DSM level measurement system</b><br/><i>Differential settlements</i></p> <p><b>12 Surface clinometers</b><br/><i>Vertical inclination of buildings</i></p> |
|---|---|

Figure 2 Monitoring Techniques (Lunardi, 2008)

Tunnel monitoring has two main aims. The first aim of tunnel monitoring is to assist the construction by confirming whether forecasted behavior of the rock mass fits to the actual conditions and deformations of the ground. The second one is to ensure the tunnel structure will be able to accomplish the operation for which it was designed, not only for construction of first-phase linings but also during its service life after final lining is constructed.

### **2.1.1. Convergence Measurements**

Convergence measurements are performed with the help of distometer nails with a threaded or eyebolt heads used as reference points (Figure 3). Monitoring is performed by locating the nails around the socket, generally in three to five measurement points. All points are periodically measured to calculate the relative shortening with the help of different systems. Invar steel tape system also called tape distometer is the oldest and widely used monitoring system. Formerly, it is connected to the edges to a couple of distometer nails which are tensioned by a special dynamometric device. By means of a mechanical or digital gauge integrated into the monitoring apparatus, the coordinate difference between each pair of nails is calculated.

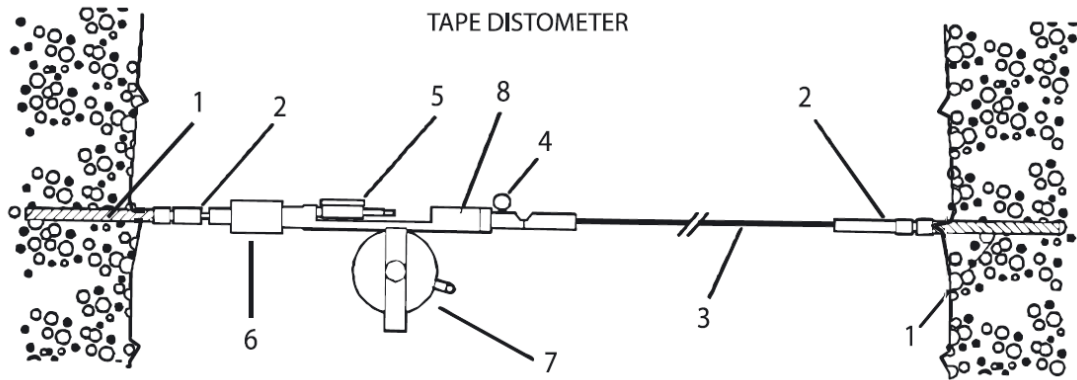

- |                                 |  |
|---------------------------------|--|
| (1) Distometric nail            | (5) Mechanical or digital gauge          |
| (2) Ball joint with connector   | (6) Tensioning device                    |
| (3) Perforated steel invar tape | (7) Tape winder                          |
| (4) Gudgeon pin                 | (8) Spring housing and tension indicator |

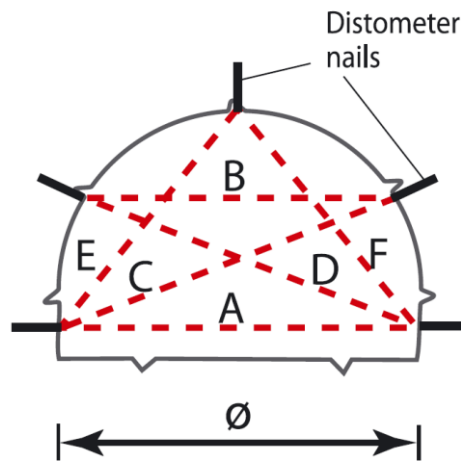

Figure 3 Convergence Measurement with Distometer (Lunardi, 2008)

Convergence meter (tape distometer) is an advantageous monitoring unit in terms of cost-effectiveness and ease of use. Yet, measuring only relative shortening and disturbing the construction progression are some of the drawbacks of this monitoring unit.

### 2.1.2. Optical Measurements

The total station device aligns the coordinates by laser beam reflection of each point. From the individually measured point coordinates, deformations can be calculated relative to zero point which is the first coordinate reading as soon as the instruments are placed. The station must be moved progressively forward from the area with the stable reference points towards the locations of the tunnel profile of interest (Vartadoks, 2007). A number of reference points is required for the photogrammetric devices to be equipped on the pre-determined points at the surface of the tunnel (Figure 4). A total station has an accuracy of about  $\pm 2.5$  mm over 100 m (Kavvadas, 2005). However, the accuracy of monitoring data is improved to the sub-millimeter level by the help of newly developed units.



Figure 4 Monitoring Target with Protection Pipe

The optical monitoring unit is advantageous as three-dimensional displacement can be measured with minimum disturbance for the construction process. Therefore, this monitoring unit is widely used in tunnel constructions. On the other hand, total station reflectors are very vulnerable to vibrations that emerge because of explosions or any other disturbance during construction processes.



### 2.1.3. Extensometers

Ground deformation along the drill hole axis can be measured at several measurement points with the help of extensometer devices. Extensometers record the changes that occur over time concerning the reference point which was fixed before starting the monitoring process in the coordinates of the measuring points (Figure 5). There are three types of extensometer devices which are incremental, single and multipoint extensometers.

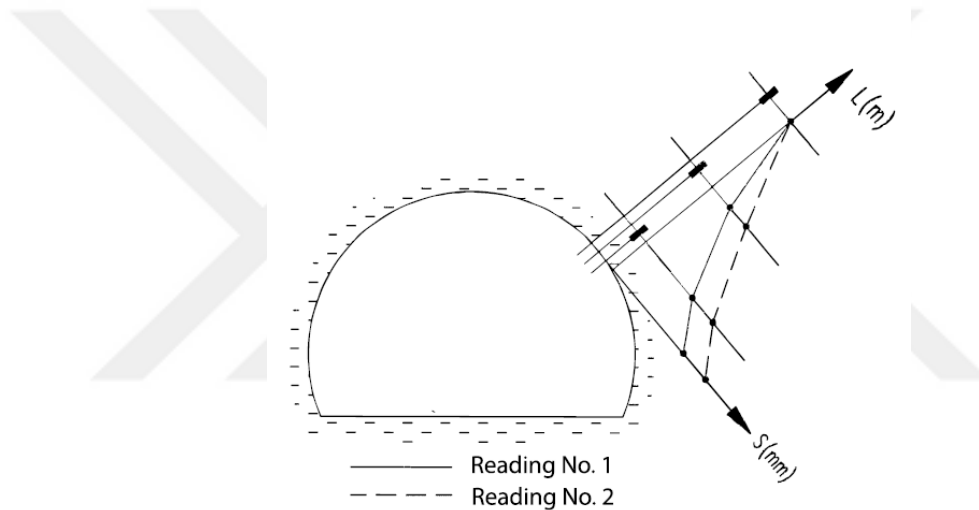

Figure 5 Extensometer Reading (Lunardi, 2008)

Extensometers can be considered as the most trustworthy tool as they have an accuracy of  $\pm 0.2$  mm over 10-15 m (Kavvadas, 2005). Yet, tape extensometers have some disadvantages to consider as their measuring abilities are limited to specific lines among the anchor points which have to be placed on the surface of the tunnel. It is not uncommon to face interference in the construction while installing the permanent anchors. Moreover, installation of the anchor points is made when there is no risk to reach the excavation area, which is generally after constructing some degree of support elements. Hence, the monitoring begins at some distance

away from the tunnel construction face. By then, most of the deformation in the tunnel has usually already taken place.

## **2.2. Numerical Methods for Tunnels**

Due to the sophisticated essence of tunnel design and analysis, engineers prefer to use numerical methods extensively. Rock mass or soil behavior can be precisely simulated, if the chosen constitutive models represent the soil or rock media appropriately.

A computational method that best satisfies the specific need should be used (Schiffman, 1972). The complexity of the problem should be considered while deciding on the computational method to be employed. When faced with a relatively less complex problem, a more basic computational method could be a better option. Whereas, when faced with a problem which tends to be more complex, the use of numerical methods might be essential. Occasionally, a tunnel project may require several approaches to be used consecutively in various stages of the design. For instance, in pursuance of workability or fundamental geometrical criteria, a closed form or analytical solution may be applied during the initial design of a tunnel. In order to verify the preliminary assumptions and conduct a thorough design analysis, the numerical method could be imperative for the final design.

Complex engineering problems can be expressed with differential equations. These higher order equations are generally too complex to be solved by linear methods. However, by numerical methods, those complex problems may be solved approximately in an iterative process. For those abilities, Numerical Methods are widely used by designers.

Numerical methods which are generally used for geotechnical engineering are detailed in the following sections. There are three types of models for numerical methods which are Continuum Model (Finite Element, Finite Difference, Boundary Element), Discontinuum Model (i.e. Discrete Element), and Subgrade Reaction Model (i.e. Beam Element).

### 2.2.1. Finite Element Method

In the Finite Element Method, the soil media is preponderantly modeled as a continuum and local discontinuities can be modeled partly. Soil or rock media is discretized into a determined number of elements called “mesh”. Those elements are connected at nodal points. Meshes are finite and their geometrical shape and size are predefined. These unique properties of the method give its name to Finite Element Method.

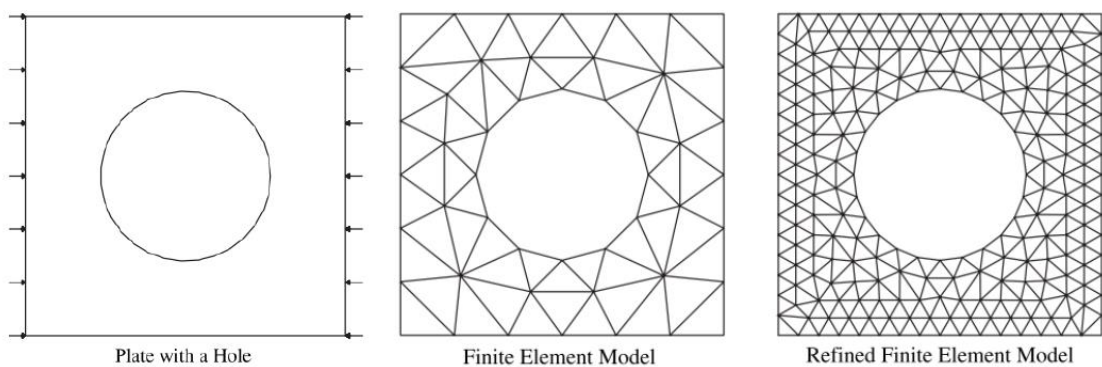

Figure 6 Representation of a tunnel by FEM (Gnilsen, 1989)

As it can be seen from the Figure 6, the finite element mesh can be formed with different elements. Larger sizes have fewer amounts of nodal points which decrease the execution time. Besides, finer meshed models take a longer time to execute with increased accuracy; since, the stress redistribution around the excavations or loadings

becomes smoother. The balance between execution time and accuracy should be optimally studied by the designer; those concerns also include the computing capacity of the utilized computer or the sensitivity of the project.

### **2.2.2. Finite Difference Method**

The Finite Difference Method is similar with Finite Element Method in terms of modeling the ground as a continuum which is divided into number of elements that are interconnected at their nodal points. However, the method is based on the explicit approach differs from the Finite Element Method is based on implicit approach.

The explicit method builds on the idea that for a small enough time step, a disturbance at a given mesh point is experienced only by its immediate neighbors. This implies that the time step is smaller than the time that the disturbance takes to propagate between two adjacent points. For most Finite Difference programs this time step is automatically determined such that numerical stability is ensured. Initially conceived as a dynamic, i.e. time related, computation approach the Finite Difference method can be used to solve static problems by damping the dynamic solution. Then, "time step" does not refer to a physical but rather to a problem solution (time) step. Analyzed velocities relate to displacement in length per time step.

The separate solution for individual mesh points implies that no matrices need to be formed. For each time step an individual solution is obtained for each mesh point. The calculation cycle leading to the solution involves Newton's law of motion and the constitutive law of the in situ material. The acceleration solved for a mesh point is integrated to yield the mesh point velocity, which in turn is used to determine the strain change. Subsequently, strains determine the corresponding stress increments

which in turn generate forces on the surrounding mesh points. These are summed to determine the resulting out-of-balance force which relates to the acceleration that started the calculation cycle.



### **2.2.3. Boundary Element Method**

Nowadays, the Boundary Element Method is applied widely. It is generally used for static whether it is linear and non-linear, dynamic and thermal analysis of solids. Likewise, this method, which is becoming more and more common in tunnel engineering, is also used to simulate transient heat transfer and transient thermal visco-plasticity. (Banerjee and Dargush, 1988).

Finite Element Method, Finite Difference Method, and Boundary Element Method all shape the ground as a continuum. Yet, there are several differences when compared with the other two continuum models. First of all, when irregularities in the groundmass are not modeled, the only part that requires a discretization of the problem domain is the excavation boundary. Numerical calculation is limited to these boundary elements. Partial differential equations usually describe and simulate the medium inside those limits. For the most part, these equations tend to be linear and they show the estimated formulations of the existing conditions. Another solution to the problem is integrating partial differential equations. Due to this approach, the Boundary Element Method is also called Integral Method.

Just like the other methods, the Boundary Element Method has some strengths and weaknesses to consider. In this method, the system of equations that needs to be dealt with is relatively smaller than those that the Finite Element Model requires. Therefore, a computer even with a limited capacity is enough. Also, data integration process is rather uncomplicated and easy. Another point to consider is that when the boundaries that are set become a great concern, the Boundary Element is cost-efficient while dealing with two or three-dimensional problems. However, the capacity of almost all boundary element programs is limited to linear constitutive ground behavior. Also, the complexity of construction procedures is another issue that is faced in the Boundary Element Method.

#### **2.2.4. Discrete Element Method**

The Discrete Element Model which is also called Distinct Element Method (DEM) is different from the other methods that are mentioned since it does not shape the groundmass as a continuum. In this model, separate blocks that are rigid in themselves shape the groundmass. This model can be applied when there is a joint displacement which overshadows the internal block deformation to an extent that the latter can be neglected. When this is the case, the movement that occurs along the joints that are between “rigid” blocks governs deformity in the groundmass.

Discrete Element Analysis starts with the computation of incremental forces acting in the joints. In order to assign different locations and directions to the block centroids, the resulting accelerations of the stiff blocks are integrated. As a result, this creates new and additional stresses to the joints which carry on the calculation cycle.

There are some strengths and weaknesses of this model as well. To begin with, the Discrete Element Method is particularly handy for kinematic studies of large block systems when highly jointed rock masses around the tunnel are modeled. In this model, there is a larger amount of block movement that can be analyzed when compared with the movement which can be attained from many different models. Furthermore, the necessary computer capacity is not as high as other methods require. On the other hand, joint locations and orientations are to be known for computation which is not easy to gather for deep tunnels.

### **2.2.5. Beam Element Method with Elastic Support**

The Beam Element Method (BeEM) is also named as the Coefficient of Subgrade Reaction Method. In this method, tunnel lining is considered to behave like beam elements. Spring elements simulate the encircling ground which provides the embedment of the lining. Spring elements are normally directed perpendicular to the lining as they simulate the usual stresses that are applied to the ground from an outward lining angle. Likewise, tangential shear stresses that are applied in spots that are between the ground and the lining can be simulated by spring elements. While determining the stiffness of the spring element, the rigidity modulus of the ground and the curves that are in the lining are considered. In order to replicate the real circumstances, spring elements which undergo tension should be eliminated from the calculations.

In order to analyze a tunnel lining, multiple computer programs may be employed through the Beam Element Method with elastic support. When set side by side with other numerical methods, in the Beam Element Method, the computer processing and storage capacity is smaller. Nonetheless, the model that is used in this method is only able to simulate rather simple or simplified ground and tunnel conditions. Also, the embedment which is presented by the area of the ground it represents is simulated in each spring element. Contrary to the real conditions, there is no connection between the spring elements that support ground areas.

### **2.3. Back Analysis in Geotechnical Engineering**

Back analysis or backcalculation procedures are very well engaged to the observational method in geotechnical engineering. The aim of backcalculation is to reconstruct the model or identify the input parameters from a set of measurements.



Peck (1969) who used observational assessment to backcalculate the design parameters for slope analyses integrated backcalculation into geotechnical engineering. Backcalculation procedure in geotechnics can be found in many applications, such as deep excavations, underground stations, and bored tunnels. The most accepted methodology of back analysis is the direct approach. The direct approach is characterized by three fundamental components; the numerical model, the fitness function and the optimization algorithm. Firstly, the numerical model includes the soil body, excavation scenario and reflects the response of the structure. Secondly, the fitness function evaluates the difference between the computed and monitored values. Finally, optimization algorithm performs the iterative process by altering the material parameters and recalculating the numerical model in order to minimize the fitness values. The summarized approach may be used with different optimization algorithms and more complicated numerical models.

Using inverse analyses to calculate the design parameters was introduced by Gioda and Maier (1980) who used monitored data from observational methods in underground constructions. A study of back analysis methods and principles that also addressed to tunneling and excavation problems was presented by Sakurai (1987). A study on displacement-based back analysis methodology is studied by Sakurai and Abe (1982). The technique produces the estimation of the elasticity modulus and initial in-situ stresses of the rock mass through the assumption of the rock as linear elastic and isotropic. Ledesma and Gens (1996) mention some of the contributions that were made to the probabilistic-based methods in back-analysis use for tunnels, which characterize a minimization process as well as a reliable estimation of the conclusive parameters inclusive of the finite element method. Deng and Lee (2001) outline a method for displacement based back analysis where a neural network and a genetic algorithm are used. De Mello and Franco (2004) carried out a backcalculation application of in-situ stresses that depend on small flat jack measurements when a mine is at hand. Deterministic and probabilistic approaches are covered in their review and examples. Pichler (2003) introduced a back analysis

where neural networks are used (NN). Their method makes use of the artificial neural network (ANN) which was developed in order to estimate the finite element simulation outcomes. When adapting the ground behavior surrounding the excavation area to the real geomechanical characteristics, these data that were backcalculated can be used.

Through back-calculation the input parameters which are to be analyzed are gathered from the measurements during the construction of the tunnel. Verifying the quantitative outcomes obtained from a previously performed numerical analysis and receiving rational input material parameters for the numerical analysis to come are the two reasons why back analyses are performed. For example, back analysis approach may be the basis of the design of the main tunnel based on displacements measured in the exploration tunnel. In the aftermath, in order to calibrate the numerical computation, the monitoring values that are gathered from the construction of the exploratory tunnel are used. The final "true" rock mass parameters have formerly resorted. The restored data is eventually used for modeling the major tunnel. In a different case, displacement measurements which were obtained during the construction phase of the tunnel may be compared with equivalent deformations which were anticipated from the numerical calculations performed for the same section. For the case where compared values are different, in order to calibrate the analysis, the measured value may be employed. Then the tunnel design is adjusted and furthered by the help of the calibrated model. Ordinarily, when ground parameters follow a more complicated constitutive law which cannot be characterized easily, a backanalysis is even more fructuous (Zeng et al.,1988). One of the special applications of back analyses is the determination of in-situ stresses from instrumental rock burst occurrences (Jiayou et al, 1988).

## **2.4. Optimization Techniques**

Optimization methods can be divided in three general groups as gradient-based, metaheuristics and enumerative methods in terms of their working procedures.

### **2.4.1. Gradient – Based Methods**

Gradient-based optimization methods try to reach the minimum of a target solution by mathematical expansions involving first or higher order derivatives. They generally search to advance the objective function value in each iteration by moving to appropriate search direction. Although, gradient-based algorithms can be computationally efficient for linear and simple problems, according to the problem solution space topology and the initial guess of the problem, the algorithm may trap into a local minimum. In complex non-linear problems, the computation of derivatives of objective function and can be tedious, time-consuming or infeasible to solve Hessian matrix.

### **2.4.2. Metaheuristic Search Methods**

Metaheuristic methods generally manage an interaction between local improvement procedures and higher level strategies to create a process capable of escaping from local optima and performing a robust search of solution space. These methods are commonly stochastic and inspired from natural phenomena, for example, Genetic Algorithms (GA) which were inspired from Darwin's evolution phenomena "survival of the fittest" having cross-over and mutation operators to solve the optimization problems. There are many metaheuristic algorithms in literature to solve optimization problems two of which namely Simulated annealing (SA) and Particle Swarm Optimization (PSO) are used in this research.

#### **2.4.2.1. Simulated Annealing**

Simulated Annealing (SA) was inspired by the annealing process of alloys of metal, crystal or glass by increasing the energy above their melting points then letting the materials to cool gradually until solidifying into an ideal crystalline structure. The idea to use of the annealing process of materials comes from the energy state changing while heating and cooling the materials. As the metals are heated, the internal energy increases making atomic configuration of the structure more ambiguous. Thus, atoms move freely to find a more stable configuration. The cooling process is continued steadily till crystallization of the particles. Eventually, the heated system minimizes its energy slowly so that the atomic structure of the system becomes perfectly ordered (Kirkpatrick, 1983). The SA technique mimics the natural phenomenon and iteratively improves the target function by perturbing the design variables in a random manner. While assessing the fitness function, successful candidates are naturally accepted. Besides, unsuccessful candidates are not directly rejected by the algorithm not to be trapped in a local optimum. Non-improving solutions are subjected to a probability function named Boltzmann distribution which determines the acceptance or rejection of the candidate design. The acceptance probability of Boltzmann function is changed throughout the optimization process. This process is called Metropolis test, which was first invented by Metropolis (1953).

There is a direct analogy of natural phenomena with an optimization procedure. The process of heating and cooling correspond to the solution of different optimization problems where multiple local optima may exist. Hence, main nature of SA is metaheuristic thus it does not involve greedy optimization criteria. Implementation of the SA is beneficial in complex geotechnical back analysis problems especially when prior information is not available or it is unreliable.

Leite and Topping (1999) have stated that “SA was not a population-based search technique and the major drawback of this algorithm was its long convergence time in

complex structures”. Thus, a parallelization scheme was proposed for the application of the SA in an environment which allows parallel programming. It was concluded throughout the study that, in order to improve the computational time performance of SA, parallelization can be used. They also stated that, parallelization of SA was a problem dependent issue for optimization.

SA is applied to many engineering problems such as cost optimization, backcalculation problems and feasible design of structural problems in the literature. Vartadoks (2007) used SA to backcalculate the geotechnical parameters. Hasancebi et al. (2010) used a modified version of SA for designing steel structures.

#### **2.4.2.2. Particle Swarm Optimization**

Particle Swarm Optimization (PSO) is a global optimization technique encouraged from the idea of imitating the biological behavior of a swarm of colonies, birds or bees. Contrary to evolutionary optimization techniques such as Genetic Algorithms, PSO is not based on the idea of the survival of the fittest. Instead, it is a collective method in which members of the population cooperate to find a global optimum in a partially random way and without any selection. Members of the population with the lower fitness functions are not discarded and can potentially be the future successful members of the swarm. The method was first invented by Kennedy and Eberhart (1995).

In a group of birds, a single particle can influence the others by discovering a more inviting way to reach the goal. Yet, every single particle needs to be arbitrary in their behavior to escape local minima and explore the search place wholly. For instance, every bird has the ability to diagnose the individual bird at the best location and speed towards it. Each bird has the freedom to discover the search place locally using their cognitive intelligence and this process is carried out until the goal is attained. Birds do not only learn from their own experiences but also from the experiences of

other birds that are in the flock which is in equipoise with local and global searches, respectively. The coordinates of the particle which are identified as the one with the best fitness value that has been acquired up till then are referred to as the personal best location (pbest). The best fitness value that has been reached altogether as a group is addressed to as the global best location (gbest). The main operator of PSO algorithm is velocity equation which contains several components and moves the party through the search space with a velocity. The search directions for every single particle are provided by the velocity and it is also updated in each iteration of the algorithm. The total acceleration terms in equipoise with local and global searches are tested with the use of different random numbers. (Eltbeltaki, 2005)

PSO was utilized to search the optimum solutions in many problems in the literature. Perez and Behdinan (2007) used PSO for optimizing structural problems. Zeng and Li (2012) modified PSO in order to minimize the weight of steel truss structures considering the design constraints.

### **2.4.3. Enumerative Search Methods**

Enumerative optimization methods aim to solve the problems by listing all the acceptable solutions of the given optimization problem. Enumerative search methods are different from other methods in terms of searching the optimum value. While an optimization problem aims to find just the best solution according to an objective function, i.e. an extreme case, an enumeration problem aims to find all the solutions satisfying some constraints, i.e. local extreme cases. This is particularly useful whenever the objective function is not clear: in these cases, the best solution should be chosen among the results of the enumeration.

The relatively new algorithm was tested on several structures and the results were compared with the results of branch and bound method. Tseng et. al (1995) improved

branch and bound method to speed up the convergence rate of the algorithm for the problems including a large number of mixed discontinuous and continuous design variables. The improved algorithm was applied to truss type structures.







## CHAPTER 3

### BACK ANALYSIS PLATFORM

#### 3.1. General

In this chapter, the steps for metaheuristics based back analysis platform developed to backcalculate the surrounding material properties of tunnels based on the field measurements are explained. The goal of this platform is to validate the prior design assumptions and improve the prior estimate for forward modeling of subsequent excavations in the tunnel project. To properly obtain the field properties of rock mass and soil around the tunnel, several steps need to be taken in the back analysis platform. These steps are generally grouped into three: (i) numerical modeling of the tunnel using the finite element method, (ii) development of an optimization scheme based on the metaheuristics, (iii) the use of field measurements to feed the back analysis platform to be able to match with the ones obtained using the FEM. In this chapter, the details of the above steps are explained.

#### 3.2. Deformation Based Backcalculation Algorithm for Tunnels

This section introduces how the proposed backcalculation algorithm is developed. Numerical models and optimization algorithms are utilized to perform deformation based backcalculation for tunnels. For this purpose, Python 3.6.0 software is used to code the entire algorithm and the tunnel model was generated with the help of PLAXIS finite element software to compute deformation at the measurement points. After computing deformations from the numerical model, the field-measured data and computed deformations data were compared. In order to minimize the difference of these sets of data, two metaheuristic algorithms were used: Simulated Annealing

and Particle Swarm Optimization. The flowchart of the backcalculation platform is presented in Figure 7.

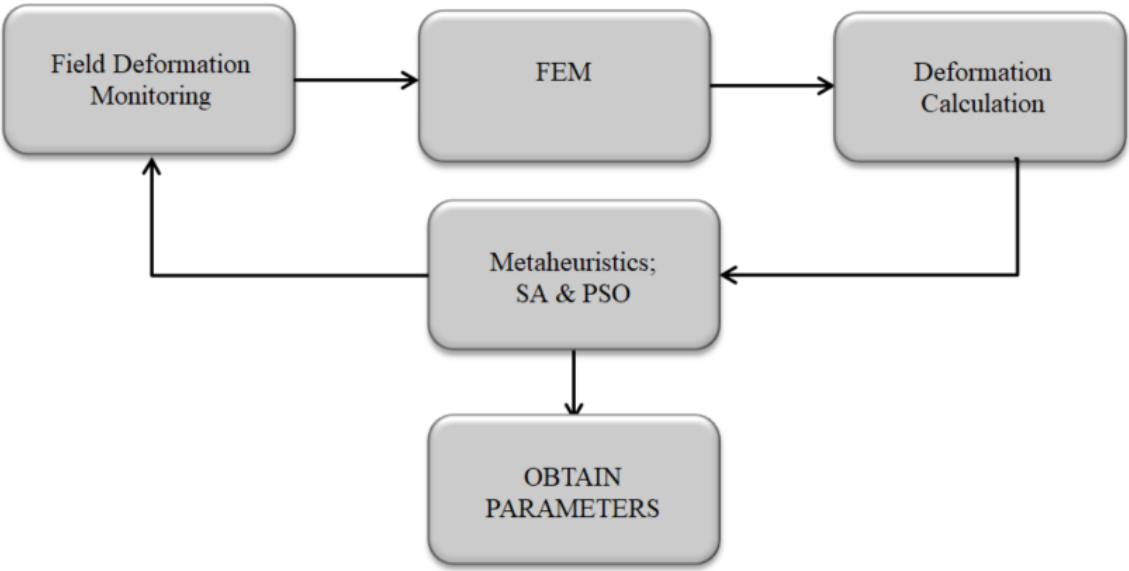

Figure 7 Back Analysis Platform Flowchart

By making use of metaheuristic algorithms, it is possible to backcalculate material properties around the tunnels needless of gradient info. Both algorithms are generally preferred due to simple implementation into well known structural software. Moreover, they are not gradient-based or greedy algorithms which make them powerful agents for sophisticated non-linear problems such as tunnels. Deformation-based backcalculation can be summarized in 6 steps:

1. Generating the numerical model including the tunnel and surrounding material by considering the construction scenario.
2. Calculation of deformation values at three measurement points with randomly selected initial material properties.

3. Calculating the fitness value by differentiating the field measurement and computed values.
4. Generating another set of random material properties and running the model with altered parameters, calculating the new deformation values at three measurement points.
5. Evaluate the fitness value and change the parameters accordingly.
6. Repeat steps 2 to 6 until reaching the minimum fitness value.

The fitness value is defined for three points on tunnel lining as:

$$f = \sqrt{(def_1 - fem_1)^2 + (def_2 - fem_2)^2 + (def_3 - fem_3)^2} \quad (1)$$

Where  $def_1$ ,  $def_2$ , and  $def_3$  values are deformation readings at the field and  $fem_1$ ,  $fem_2$  and  $fem_3$  values are computed deformation values with the help of the numerical model. The goal of the optimization algorithms is to minimize the fitness value by changing the material parameters within the selected boundaries. For this purpose, two metaheuristic optimization algorithms; SA and PSO were utilized. Optimization algorithms iteratively minimize the fitness function and try to reach an optimal solution by altering the parameters and recomputing the finite element model so that fitness function is recalculated at each iteration. Intelligent algorithms then determine how to alter the material parameters in the next run.

### 3.2.1. Finite Element Modeling Setup

Numerical modeling of a tunnel is established throughout the case-specific construction scenario. In a typical tunnel problem, the first step is considered to be the initial stage of the tunnel model prior to any tunnel excavation. In this step, in-situ stress conditions prior to the tunnel construction are assessed by considering the overburden height, lateral loads tectonic stresses if there is any. After generating the

tunnel geometry, and defining initial field conditions to the software, soil or rock media is discretized into a determined number of elements called “mesh”. Those elements are connected at nodal points. Meshes are finite and their geometrical shape and size are predefined. Finite element meshing type and size is important for underground problems since the stress redistributions and deformations are calculated at each nodal point. For complex problems including nonlinear soil-structure interactions, the mesh size should be finer at soil-structure connection points. An example of tunnel numerical model mesh is illustrated in Figure 8.

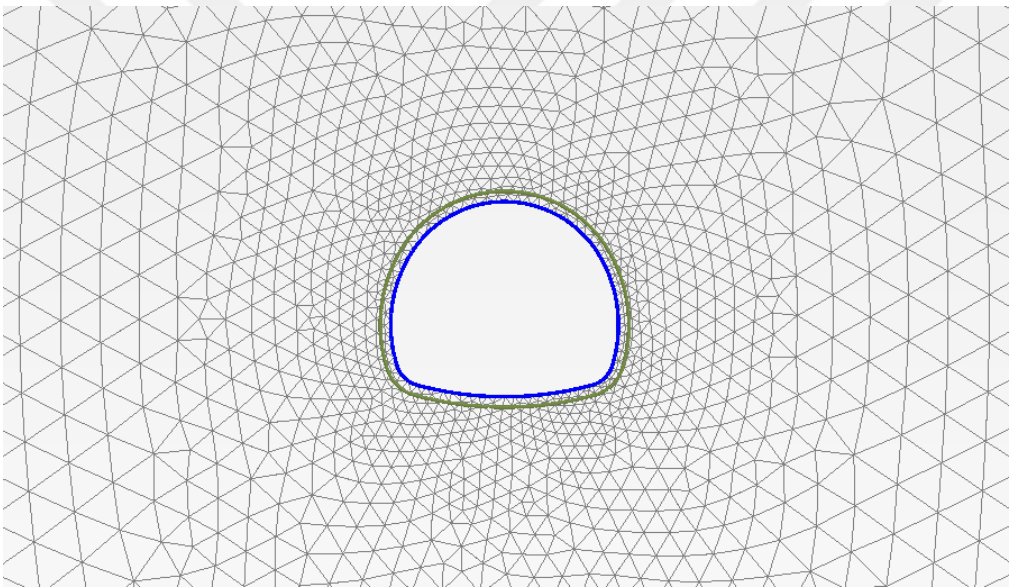

Figure 8 Tunnel Model Geometry and Generated Mesh

As the second step, material properties of idealized soil or rock layers are introduced. Each layer’s material model and general properties of geomaterials are initiated to the software so that the behavior of the tunnel is simulated accordingly. Afterward, by the help of staged construction option of the software, the construction scenario is introduced step by step according to the specific problem. Staged modeling is

important for all underground geotechnical problems because the stresses are formed with respect to the excavation and unloading of the system.

Moreover, the relaxation of the rock mass is an essential procedure for tunnels. The surrounding rock mass is let to relax some percentage of its initial in-situ stress, and then the supporting system is installed. This amount of relaxation is taken case specifically considering the support installation distance from the tunnel face and installation time. After relaxation of the rock mass, in the next phase, the support system is activated and then the tunnel is let numerically to relax fully, till the ground-support equilibrium is achieved. Prior to analyzing the tunnel model, field measurement points are selected on the tunnel periphery according to the measurement coordinates. Finally, the analysis is completed and deformations at the selected points are gathered.

The failure criterion for the rock masses is generally represented by Hoek-Brown criterion which was introduced to provide input data for the analyses required for the design of underground excavations in rock. The Hoek-Brown failure criterion is universally acknowledged for rock masses and has been applied in a large number of projects around the world (Hoek & Brown, 1980). Hoek-Brown criterion is defined by the equation:

$$\sigma'_1 = \sigma'_3 + \sigma_{ci} \left( m_b * \frac{\sigma'_3}{\sigma_{ci}} + s \right)^\alpha \quad (2)$$

In which,  $\sigma'_1$  and  $\sigma'_3$  are the major and minor effective principal stresses at failure,  $\sigma_{ci}$  is the uniaxial compressive strength of the intact rock material,  $m_b$ ,  $\alpha$  and  $s$  are material constants, where  $s=1$  and  $\alpha=0.5$  for intact rock. The coefficients  $m_b$ ,  $s$  and  $\alpha$  are defined as (Hoek, Carranza-Torres & Corkum, 2002):

$$m_b = m_i \exp\left(\frac{GSI-100}{28-14D}\right) \quad (3)$$

$$s = \exp\left(\frac{GSI-100}{28-3D}\right) \quad (4)$$

$$\alpha = 0.5 + \frac{e^{-GSI/15} - e^{-20/3}}{6} \quad (5)$$

In which, GSI is the Geological Strength Index (Marinos & Hoek, 2000), varying from 1 to 100. D is disturbance factor to include the degree of disturbance of rock mass during construction having values from 0 to 1.

### **3.2.1. Metaheuristics Based Optimization**

In order to minimize the difference of computed deformations and field-measured deformations, metaheuristics based optimization algorithms; Simulated Annealing and Particle Swarm Optimization are used. In the following sections, their working scheme is presented.

#### **3.2.1.1. Simulated Annealing Algorithm**

The metallurgical process (heating and slowly cooling) of metals such as certain alloys of metal, crystals, or glass gives its name to the Simulated Annealing algorithm. A slow cooling process which is steady and adequate produces a perfect crystalline structure that has the minimum amount of flaws and displacements. This phenomenon coincides to a state where there are low internal energy levels. On the other hand, final product gains more flaws and imperfections, when a fast cooling schedule is followed. During the cooling process of the material, the atomic compound of the structure becomes unstable and naturally finds its own optimization way for the existing conditions. The annealing algorithm tries to replicate this unique process.

In SA operation, the particles move from the current solution to one of its neighbor in a given neighborhood structure. The operation begins with an initial solution, and measure the change ( $\Delta$ ) between the objective function ( $f$ ) of the newly generated solution ( $\varphi^*$ ) in the neighborhood and the current solution ( $\varphi$ ). Differential energy is stated as the change in objective function and formulated as follows:

$$\Delta E = f(\varphi^*) - f(\varphi) \quad (6)$$

Metropolis et al. (1953) suggested an algorithm simulating the transition between different energy levels of a system in a heat bath to thermal equilibrium. In regard to the findings of the study and the principles of statistical mechanics, they formulated the Boltzmann distribution. “In simulated annealing, all random moves depend on the Boltzmann distribution in the search space “(Szewczyk and Hajela, 1993). The possibility of a shift in the state is identified by the Boltzmann distribution of the energy difference between the two states:

$$P = e^{-\frac{\Delta E}{K \cdot T}} \quad (7)$$

where P denotes the probability of achieving the energy level E, and K is called the Boltzmann’s constant, can be regarded as normalization constant which is formulated as follows:

$$K_c = \frac{K_p \cdot (N_b - 1) + \Delta E}{N_b} \quad (8)$$

Where;  $K_c$  and  $K_p$  parameters refer to current and previous Boltzman parameters respectively.  $N_b$  is the number of bad solutions which counts the number of solutions when  $\Delta E > 0$ .

In Equation 3, T denotes the current temperature which is decreased through the cooling cycles, by a cooling factor alpha ( $\alpha$ ). At the initialization of the process, starting temperature ( $T_s$ ) and final temperature ( $T_f$ ) are calculated based on selected starting acceptance probability ( $P_s$ ) and final acceptance probability ( $P_f$ ) by following formulas:

$$T_s = -\ln(P_s)^{-1} \quad (9)$$

$$T_f = -\ln(P_f)^{-1} \quad (10)$$

$$\alpha = \frac{\ln(P_s)^{\frac{1}{N_c-1}}}{\ln(P_f)} \quad (11)$$

Where  $N_c$  is the number of cooling cycles which redistributes the particles for each cooling cycle with the decreased temperature value. As the number of cooling cycles increases, the execution time increases accordingly; on the other hand, if the number of cycles is not enough, the chance of approximation to the global optima decreases. Therefore, it is crucial to determine the number of cooling cycles properly. The Boltzmann equation indicates that at high temperatures the system almost has a uniform possibility of being at any energy state; whereas when there are low temperatures the system has a small possibility of being at the state of high-energy. This suggests that controlling the temperatures can help control the convergence of the simulated annealing algorithm when the search phase is expected to adopt Boltzmann's probability distribution. In other words, the possibility of uphill moves in the energy function ( $\Delta E > 0$ ) is large at high T, and is low at low T. Simulated Annealing is different from other greedy algorithms in the way that the algorithm allows worse moves in a contained manner by attempting to advance local search by sporadically taking a chance and consenting to a solution that is worse. Therefore, it becomes possible to escape from a local minimum and have better



chance to catch the global minimum in the topology. Flowchart of the SA algorithm is presented in figure.

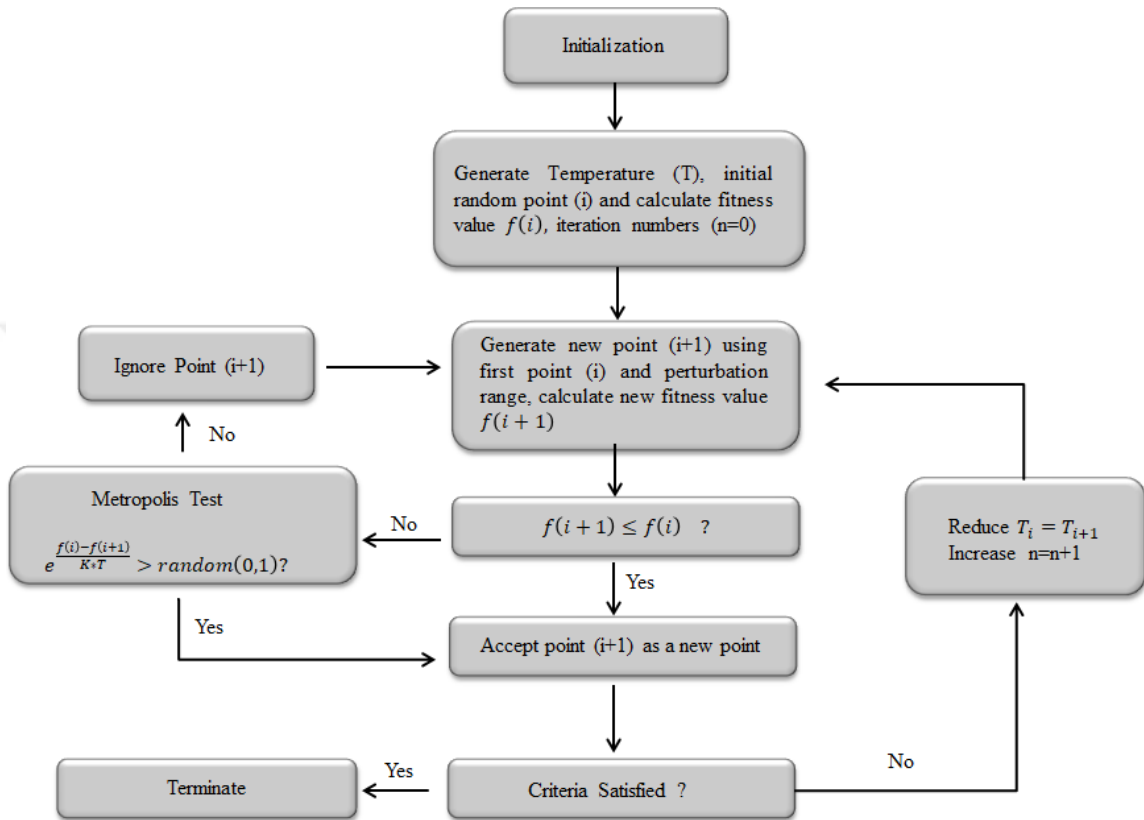

Figure 9 Simulated Annealing Flow Chart

As detailed in above, theoretical ground of the Simulated Annealing algorithm puts forward that if the cooling schedule at an adequately low speed, there is a higher possibility to reach to an optimal solution that is global. Slow cooling phenomenon is particularly useful in cases of nonlinear objective functions as in tunnel case study detailed in Chapter 4.

### 3.2.1.2. Particle Swarm Optimization Algorithm

Particle Swarm Optimization is an evolutionary method inspired by the natural movement and intelligence of animal social behaviors such as flocking. PSO algorithm cultivates a community of particles, in which all particles link together with a probable solution for an optimization problem. In fact, the retraction of particles in iteration is addressed as swarm. The terms particle and swarm are parallel which will be used in this chapter more often.

The procedure is followed at each iteration, every “particle” in “swarm” change its location with a velocity in the “search space”  $x$  is expressed as a probable solution in the “search space” of optimization problem.

$$x_i(n) = \{x_{i,1}(n), \dots, x_{i,d}(n)\} \quad (12)$$

The formula states that; the location of  $i$ 'th “particle” in iteration  $n$ ,  $x_i^{pbest}(n)$  is the previous best solution found by the  $i$ 'th particle to the iteration  $n$ , and  $x_i^{gbest}(n)$  is the position of the best particle in the neighborhood of particle  $x_i$  up to iteration  $n$ . The new position of the particle  $i$  in iteration  $k + 1$ ,  $x_i(k + 1)$  is computed by adding a velocity,  $v_i(k + 1)$  to the current position  $x_i(k)$

$$x_i(n + 1) = x_i(k) + v_i(n + 1) * \Delta t \quad (13)$$

Where  $v_i(n + 1)$  is the “velocity” of the “particle”  $i$  at iteration  $n + 1$ , and  $\Delta t$  is the change in the time. For standard PSO applications, time increment can be taken as 1.

The velocity vector is computed as;

$$\begin{aligned} v_i(n + 1) = & w * v_i(n) + c_1 * D_1(n) * (x_i^{pbest}(n) - x_i(n)) \\ & + c_2 * D_2(n) * (x_i^{gbest}(n) - x_i(n)) \end{aligned} \quad (14)$$

where  $w$ ,  $c_1$  and  $c_2$  are weights;  $D_1(n)$  and  $D_2(n)$  are diagonal matrices whose diagonal components are evenly assigned arbitrary variables in the range of  $[0, 1]$ . Parameters taken for the case study will be discussed in Chapter 4.

The velocity equation has three segments,  $w$  is referred as the inertia,  $c_1$  and  $c_2$  terms cognitive and social components respectively. Flowchart of the PSO algorithm is presented in figure.

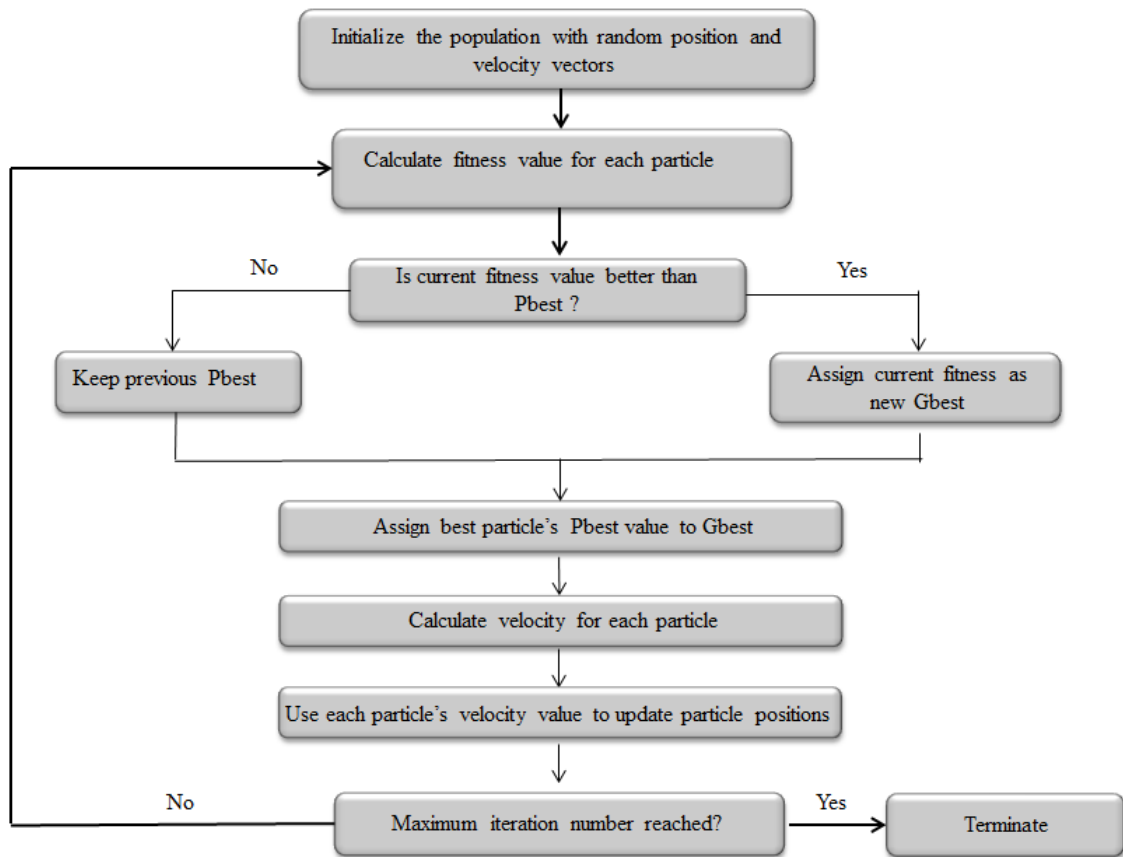

Figure 10 Particle Swarm Optimization Flowchart



## CHAPTER 4

### CASE STUDY: ANKARA-ISTANBUL RAILWAY - T26 TUNNEL

In this chapter, first, the detailed information about Ankara –Istanbul High-Speed Railway project including the geology of the site and geotechnical information related to tunnel area are provided together with the information for the monitoring of T26 tunnel. Application of the back analysis platform developed to estimate the soil and rock mass properties are then explained thoroughly. Then the performance of the back analysis platform is presented when the field data obtained from T26 tunnel are provided. The details of the parameter settings for the back analysis platform can be found in this chapter. Finally discussion of the results is at the end of this chapter in the light of the findings.

#### 4.1. Project Information

Ankara-İstanbul high-speed railway connects the two biggest cities of Turkey: İstanbul and Ankara, which reducing the travel time to approximately 4 hours. As one of the biggest projects of Turkey's construction market, this high-speed railway project mainly aims to provide a safe, economical, and fast transportation system between the two most populated cities; enabling the transportation between the two cities at a maximum speed of 250 km/h . State Railways of Turkish Republic (TCDD) divided the project into two phases. The first phase involved the construction of a 251 km section of the fast line between Sincan (Ankara) Station and İnönü (Eskisehir) Station, which costed about \$747 million. The second phase of the project is located between Inonu Station and Pendik (Istanbul) Station, which is

about 214 km long and costed \$2.21 billion according to the signed contracts. The second phase also includes 33 bridges and 39 tunnels located along the challenging terrains, which resulted in higher costs. Both projects were completed and taken into service.

The subject of the study, T26 tunnel, is approximately 6100 m long single-tube tunnel which was included in the second phase of the project (Figure 11). The tunnel passes through weathered to highly weathered graphite-schist material. The construction of the tunnel was completed in August, 2011. During the construction, monitoring instruments were installed on the tunnel lining to periodically measure the deformations.

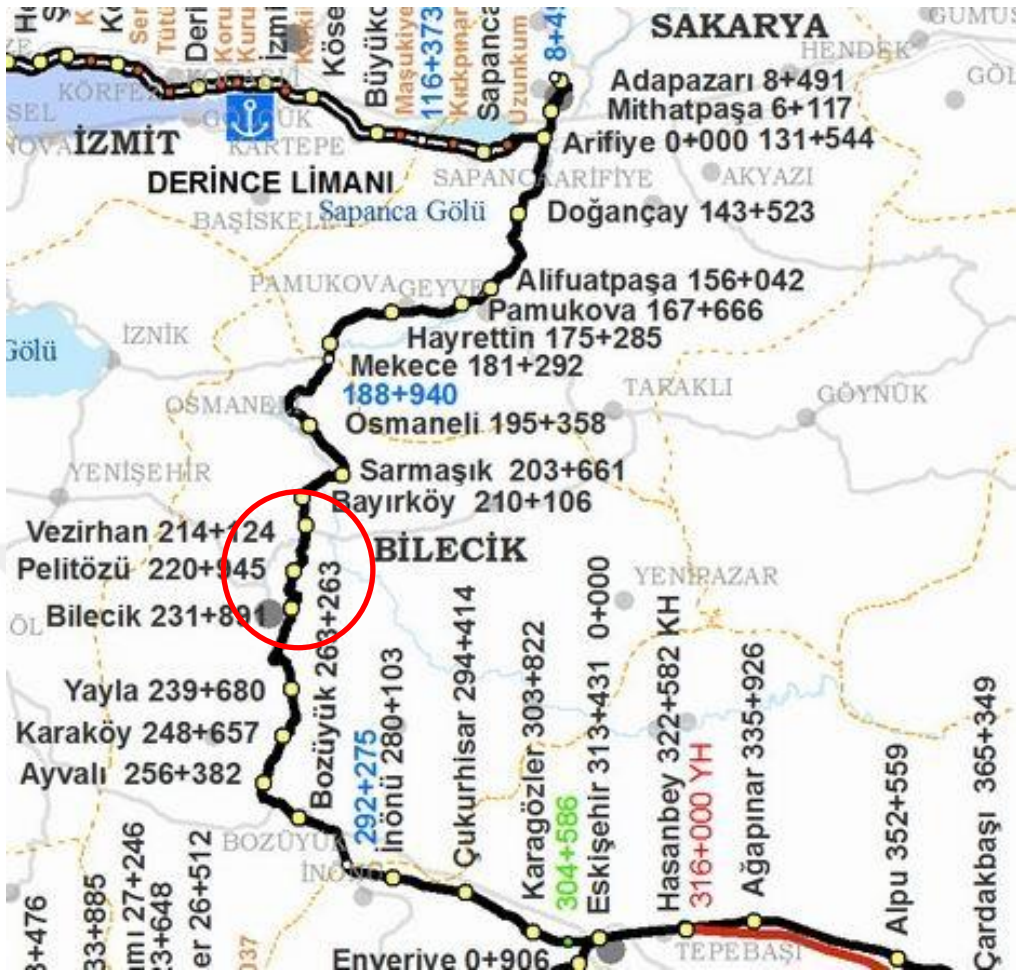

Figure 11 The location of T26 Tunnel

#### 4.1.1. Geology of the Tunnel's Project Area

The tunnel is located at Km: 216+260 - 222+360 in a steep topography between the Vezirhan and Bozüyük stations. The overburden height of the tunnel varies between 30-236 meters.

İnönü-Köseköy part of the tunnel constitutes a section of about 100 km of the project and it goes through the E-W trending mountain range. The area appears to be tectonically active and the ground conditions seem to be unfavorable for tunnel

construction as the planned route of the tunnel is covered with swelling and squeezing rock conditions.

Pazarcık Complex, which belongs to the Paleozoic age, exists through the tunnel alignment along with unit outcrops between Bilecik and Bozüyük and numerous overlapping rock structures. The unit presents erosional contact relation with the Triassic aged Karakaya Group on top, and eroded, as well as the partly faulted Bayırköy formation. The unit, on the whole, has gone through metamorphism under green schist facies conditions and made of structurally embedded rock of various thicknesses. Within the widespread outcropping schists, sandstones, marbles, migmatite-gneiss, and granodiorite were found in the form of mega blocks. The unit is cut by the quartz and aplite dykes of the Bozüyük granitoid.

The main unit which is between KM: 216+260 and KM: 222+360 is graphitic schist. Graphitic schists are black – dark grey – greenish dark grey colored, with apparent schistosity, fragmented, medium to highly weathered and weak to medium strong (ISRM, 1981). Within the graphite schists which can easily be separated along the schistosity planes, a few marble blocks with lengths of 10 m, quartz seams of up to 2m thickness, as well as mica schists in the form of mega blocks were observed.

#### **4.1.2. Construction and Monitoring of T26 Tunnel**

T26 Tunnel was constructed according to New Austrian Tunneling Method (NATM) and sequentially excavated in three sections; top-heading, bench and invert excavation (Figure 12). Tunnel construction was achieved by conventional methods with respect to the rock mass conditions. As NATM procedures dictate, the rock mass around the tunnel was classed into several groups according to Austrian standard (ÖNORM B2203) and then matched with specific support types as preliminary design. T26 tunnel was classed into B2, C2 and C3 classes during



designing phase of project. The modeled and backcalculated section is located in C3 class type of rock. C3 type of rock is considered as heavily squeezing type of rock and its support system and excavation sequence is predefined. However, NATM gives the opportunity to “design as you go” procedure which means the final design is reconsidered based on the field observations during construction. Therefore, monitoring is crucial for NATM tunnels.

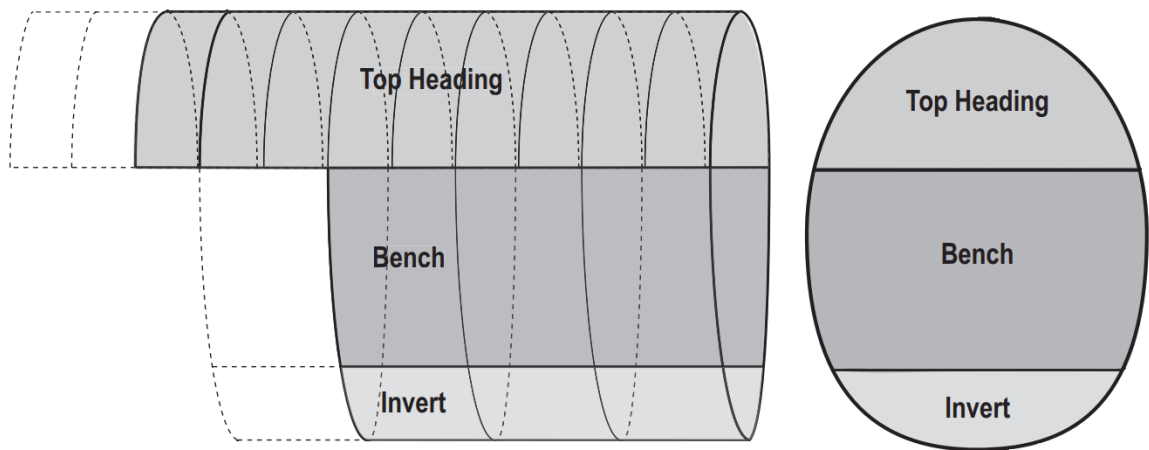

Figure 12 Tunnel Excavation Sequence

During the construction of T26 tunnel, excavation is monitored by total station device and optical reflectors at three sections on the tunnel periphery (Figure 13).

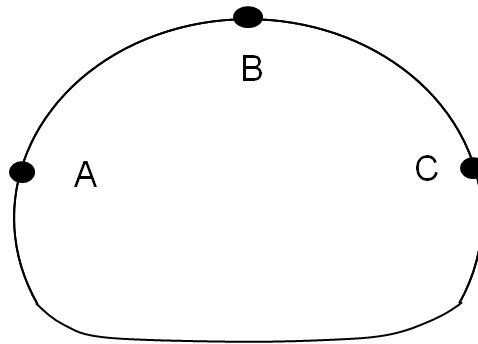

Figure 13 Monitoring Points

T26 tunnel and backcalculation procedures were done according to optical deformation measurements. During 150 days of monitoring, the deformation versus time plot was generated and as it can be seen from the plot in Figure 14, deformations reached 2 mm/month equilibrium which is regulated by Turkish Railways before constructing the inner lining. The inner lining is designed with the idea that forces due to rock mass relaxation do not act on that element.

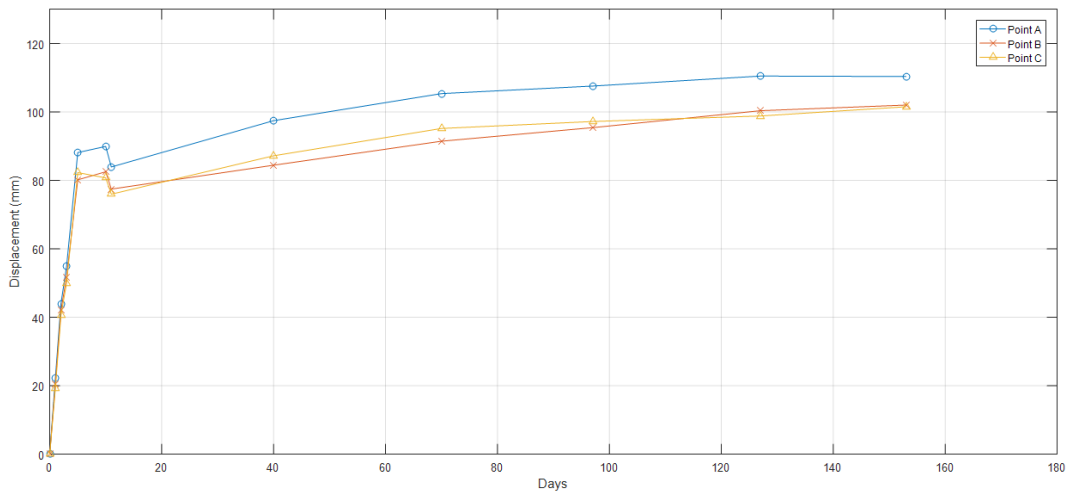

Figure 14 Deformation Data

As it can be seen from Figure 14, the deformations reached equilibrium in approximately two months. Final measurements are measured as follows in Table 1.

Table 1 Deformation Measurements at Reading Points Km:216+524

READING POINT	DEFORMATIONS (mm)
A	110mm
B	102mm
C	101mm

#### 4.2. Finite Element Model

The tunnel model was developed by extending the media 120m in the horizontal direction and 100m in the vertical direction approximately five times the tunnel diameter from the tunnel edges so that stresses are equalized to natural conditions boundaries of the model. The radius of a typical single tube railway tunnel is 12 m. The numerical model was computed by PLAXIS, in order to run the program with the varied set of parameters over and over again, the program was coupled with Python. Ground media is discretized into a determined number of elements called “mesh”. Those elements are connected at nodal points. The fine mesh option is selected for the element distribution in order to simulate better for soil-structure interactions and possible plastic zone. Meshes are finite and their geometrical shape and size are predefined. Constitutive model was meshed with six-noded triangular elements. Around the tunnel and support elements, the sizes of meshes are refined for a smooth redistribution of stresses. General coarseness factor is selected as 0.12 and refined in the vicinity of opening. The generated model geometry and mesh is illustrated in Figure 15.

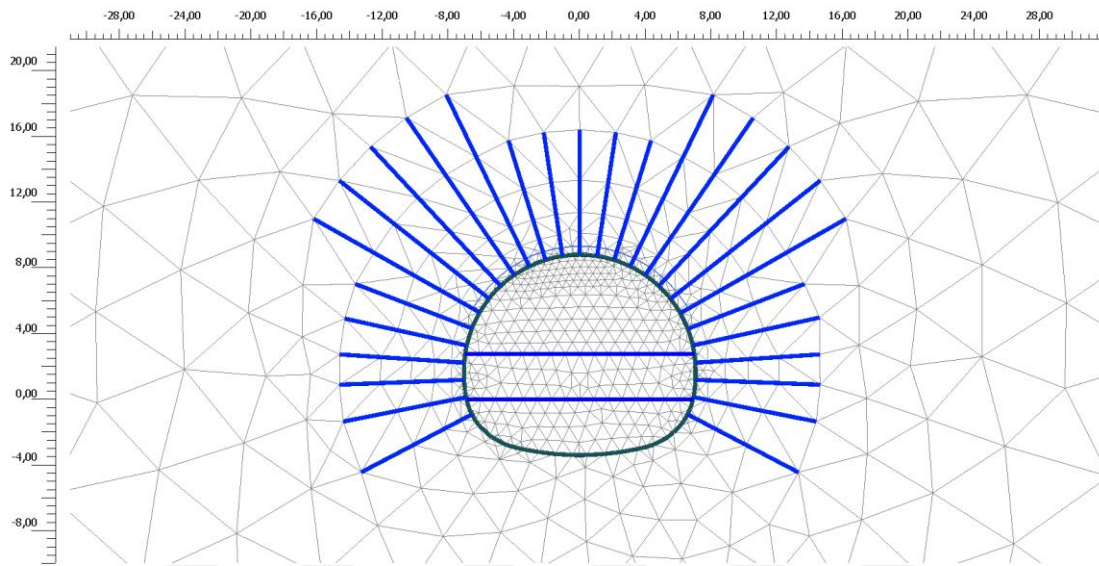

Figure 15 Model Geometry and Generated Mesh (PLAXIS 2D)

The failure criterion for the rock mass is represented by Hoek-Brown criterion which was introduced in Chapter 3. Hoek-Brown model considers elasto-plastic behavior for the rock mass around the tunnel, which is universally acknowledged and recently added to PLAXIS.

Optical displacement measurements took place on the tunnel periphery at three certain points. Therefore, those certain points were marked so that, precise deformation values were calculated at marked nodal points (Figure 23). Moreover, with the help of staged construction option, tunnel segmental modeling was established; different phases were initialized to the numerical model so that model represents the construction scenario more precisely. In tunnel structures the main load carrying element is rock itself, therefore during the construction of tunnels, after the sequential excavation of the tunnel face, rock mass is let to relax for a while before the installation of support elements. In order to simulate the initial relaxation of the rock mass, the excavation and the activation of the support elements did not

take place in the same phase. The tunnel periphery is let to relax at 70% of its initial in-situ stress in the excavation phase, which means weathered rock itself deformed first, and then support is installed. This amount of relaxation is taken arbitrarily for this example and practically corresponds to support installed at some small distance from the tunnel face. Then the tunnel is let numerically to relax fully, until ground-support equilibrium is achieved. Tunnel support is composed of 40 cm thick fibre and mesh reinforced shotcrete liner with steel girders and 8 to 12 m rockbolts. The model consists of seven phases which can be seen in the following figures.

- The First phase represents the initial field condition (Figure 16).

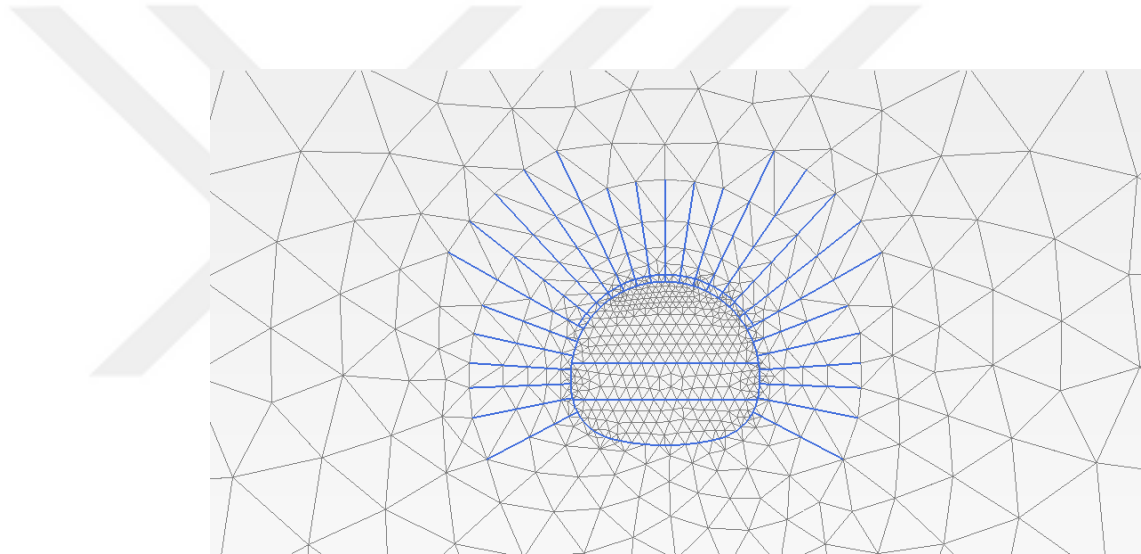

Figure 16 Initial Phase

- Second phase; the top-heading segment is excavated, forepolling region was activated and the rock mass is gradually relaxed to 70% of initial stress (Figure17).

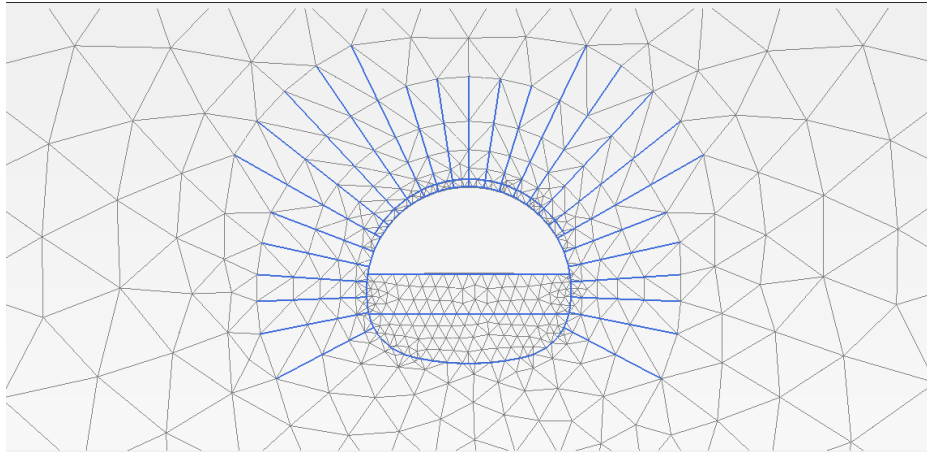

Figure 17 The Second Phase

- Third phase; construction elements of the top-heading segment were activated then rockmass is fully let to relax (Figure 18).

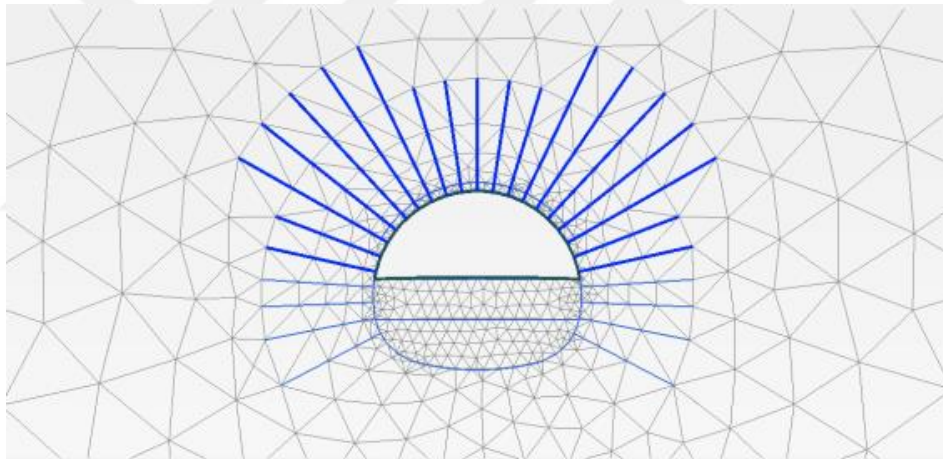

Figure 18 The Third Phase

- Fourth phase; the bench segment is excavated and the rock mass is gradually relaxed to 70% of initial stress (Figure 19).

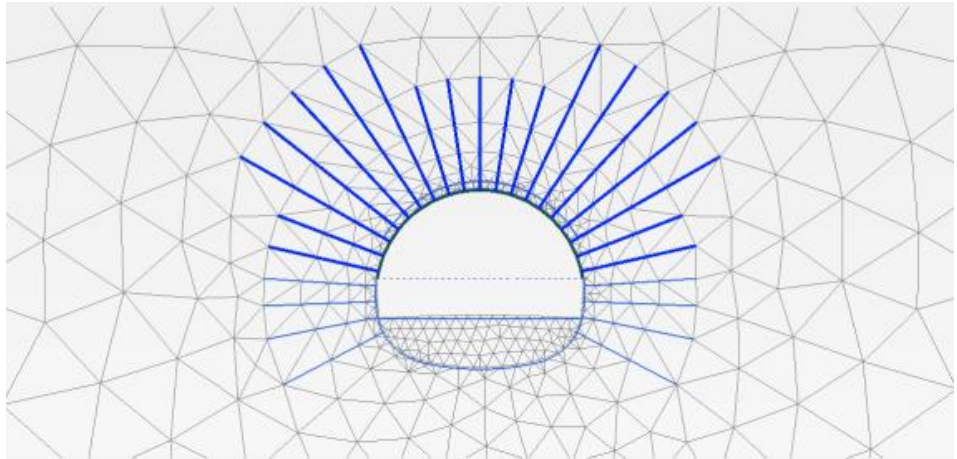

Figure 19 The Fourth Phase

- Fifth phase; construction elements of the bench segment were activated then rockmass is fully let to relax (Figure 20).

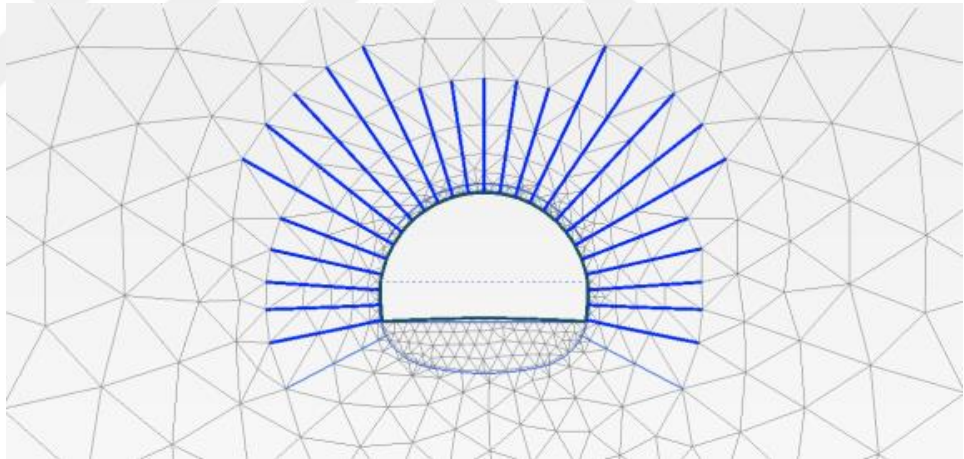

Figure 20 The Fifth Phase

- Sixth phase; invert segment were excavated and rockmass is gradually relaxed to 70% of initial stress (Figure 21).



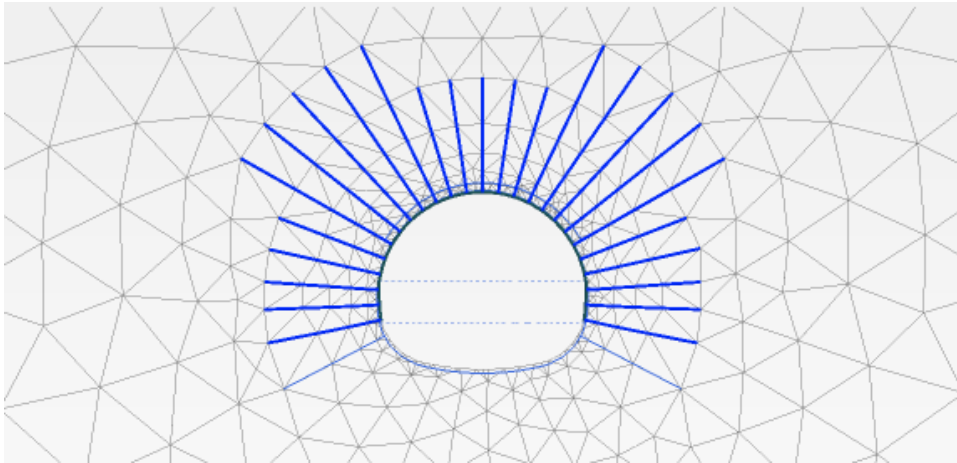

Figure 21 The Sixth Phase

- Final phase; construction elements of the invert segment were activated then rockmass is fully let to relax (Figure 22).

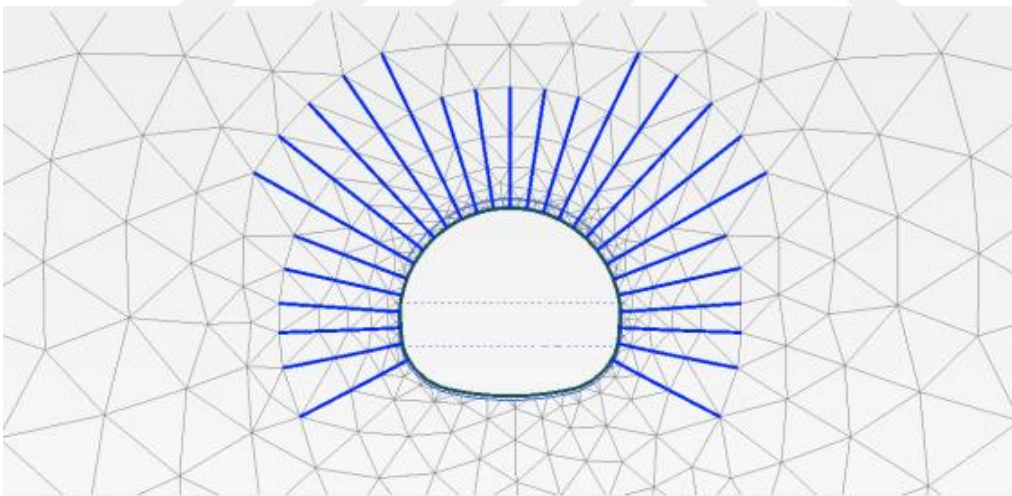

Figure 22 Final Phase

The process above summarizes the phases of numerical model which was established to be similar with the real tunnel construction. The quality of the rock mass surrounding the tunnel is poor and the overburden height is low. Therefore, the



deformations around the tunnel are expected to be extensive, the monitoring results prove this fact. Monitoring points A, B and C were selected on the model and at those locations, deformation results were gathered and saved at each run of program. Locations of the monitoring points around the tunnel are illustrated in Figure 23.

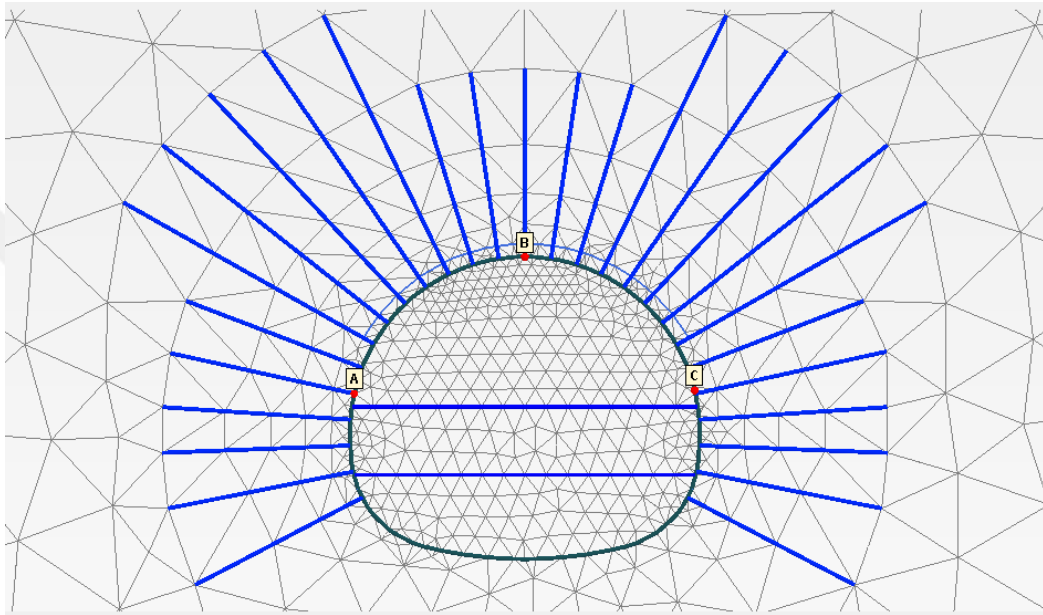

Figure 23 Locations of the Monitoring Points Around the Tunnel

The constituted finite element model was used for both Simulated Annealing and Particle Swarm Optimization algorithms. In order to compare the algorithms same model and the same initial parameter selections were kept. Also, the same programming language was used for simplicity and to run the PLAXIS model. In following sections the results of both algorithms were presented.

Constraints of the problem were the four parameters of rock mass; elastic modulus (E), geological strength index (GSI), uniaxial compression strength (UCS) and Coefficient of Earth Pressure ( $K_0$ ) The boundaries of the parameters were selected before the problem tabulated in Table 2.

Table 2 Parameter Constraints

Parameter	E (Mpa)	GSI	UCS (Mpa)	Ko
Constraints	50-400	10-30	1-25	0.5-1.5

For the initial trial run of the model, the average values of these material parameters were initiated. Rest of the parameters which are unit weight of rock mass ( $\gamma$ ), Hoek Brown parameter ( $m_i$ ), Disturbance Factor (D) and Poissons Ratio ( $\nu$ ) were selected with respect previous studies during design stage of the tunnel. Initial parameters table is presented in Table 3.

Table 3 Initial Parameters

Parameter	E (Mpa)	GSI	UCS (Mpa)	Ko	$\gamma$ (kN/m <sup>3</sup> )	$m_i$	D	$\nu'$
Constraints	250	20	8	1	23,00	10,00	0.5	0.25

#### 4.3. Metaheuristics Based Parameter Calculation

In the case study of T26 tunnel, four parameters; elastic modulus (E), geological strength index (GSI), uniaxial compression strength (UCS) and Coefficient of Earth Pressure at rest ( $K_o$ ) are backcalculated, Assuming that monitoring data is reliable and the construction scenario is well represented in the numerical model, the selected parameters are back analyzed with a tolerable fitness value. The reliability threshold of the fitness value is calculated by concerning the measurement and reading errors as 5 mm. To illustrate, for 5 mm reading error for three measurement points, the fitness value is calculated as 0.009 m. In other words, for the fitness values lower

than 0.009 m, gathered displacements are the same with the computed ones and can be regarded as a feasible solution concerning the measurement errors.

### 4.3.1. Particle Swarm Optimization Performance

After establishing the back analysis platform, results are obtained with PSO algorithm as follows. For the algorithm, the number of particles is selected as 50 and the iteration number is selected as 30 concerning the execution time and the approximation to the measured values. Also, the velocity equation has three components;  $w$  is referred as the inertia,  $c_1$  and  $c_2$  terms are cognitive and social components respectively. These parameters are selected as 0.9, 2, 2 respectively for this particular tunnel problem.

All particles in the swarm represent a solution in the search space. At each iteration, particles change their positions with a velocity in the search space. The best position of all particles in the swarm is called as Gbest. The decrease of the Gbest values for thirty iterations can be seen from the Figure 24.

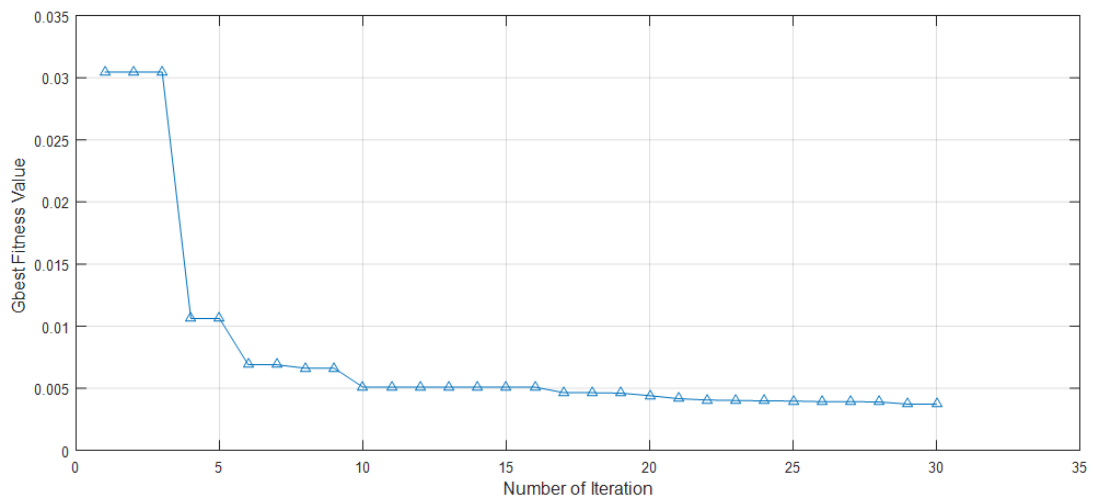

Figure 24 Gbest Fitness Value vs Number Of Iteration

The graph indicates that, best fitness value of each iteration (Gbest) decreases gradually. When coming towards to the end of analysis, Gbest value reaches equilibrium at 0.004 m which is a tolerable value. For the best feasible design having fitness value 0.0037, the parameters are backcalculated by the help of PSO. The results are tabulated in Table 4.

Table 4 Observed Parameters - PSO

Parameter	E (Mpa)	GSI	UCS (Mpa)	Ko
Final Solution	199.90	15.00	3.50	0.94

#### 4.3.2. Simulated Annealing Performance

Back analysis platform was also established using SA algorithm to minimize the fitness function. Although, both PSO and SA algorithms are metaheuristic in nature, their approximation and the working procedures are totally different. SA algorithm minimizes the fitness function with a metallurgical process, decreasing the internal energy and acceptance probability at each cooling cycle. In other words, SA accepts the uphill movements with a higher acceptance probability at the first stages of optimization process, and reduces the probability of accepting bad moves as getting close to the optimum solution.

The first step was the setting the cooling schedule properly for the specific problem. The starting accepting probability ( $P_s$ ), final accepting probability ( $P_f$ ) and number of cooling cycles ( $N_c$ ) were chosen as;

$$P_s = 0.5, \quad P_f = 0.001, \quad N_c = 200$$

With respect to the selected parameters, starting temperature, final temperature and cooling factor were calculated by the formulas defined in Chapter 3. The starting temperature was assigned as the current temperature of the process. For the next step, the boundary conditions of the four parameters were assigned to the algorithm as in Table 5.

Table 5 Boundary Constraints

Parameter	E (Mpa)	GSI	UCS (Mpa)	Ko
Constraints	50-400	10-30	1-25	0.5-1.5

As an initial design generation, the parameters were selected randomly in between the boundaries. For the following step, number of candidate designs is generated in the close vicinity of the current design by altering the parameters in predefined perturbation range, for the case, perturbed values violate some of the boundaries of constraints; the values are fixed to the closest constraint edges. Perturbation value is selected as 10% of the range of each parameter. Perturbation values are illustrated in Table 6.

Table 6 Perturbation Values

Parameter	E (Mpa)	GSI	UCS (Mpa)	Ko
Perturbation	35	2	2	0.1

Each time when a candidate design is generated, its objective function is calculated and compared with the current design. If the candidate design provides a better solution, it is automatically accepted. Otherwise, the candidate design is subjected to the Metropolis Test, if the design passes the probabilistic test with the current acceptance probability, the solution is accepted. If the current design fails the test,

the current design maintains itself. Iterative process can be seen from the fitness value change by number of analysis from Figure 25.

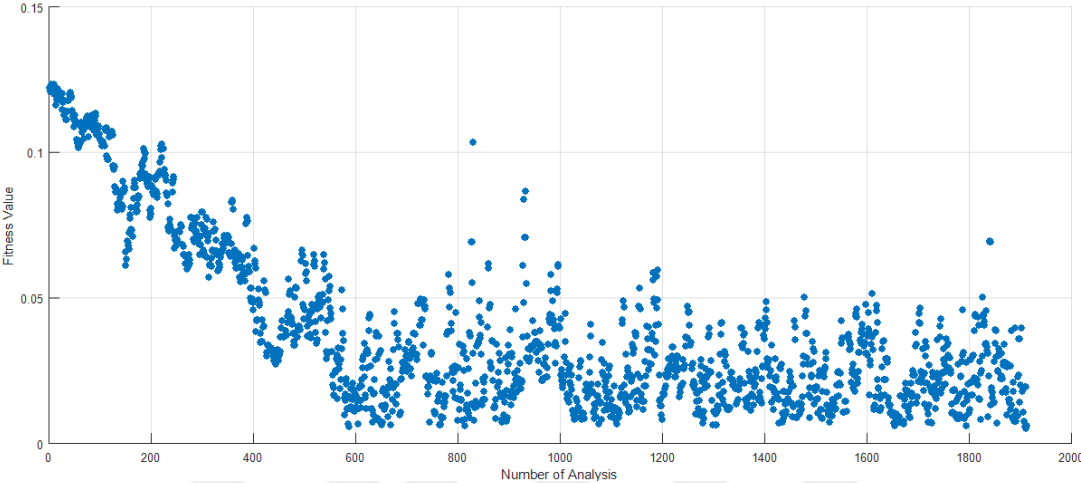

Figure 25 Fitness Value vs Number of Analysis

As it can be seen from the Figure 25, initial fitness value is calculated around 0.12 in initial runs, then it is dramatically decreased when approaching towards the end of analysis. In Figure 26 best fitness function considering the difference of field measurements and computed measurements in meters against the number of finite element model evaluations graph was plotted.

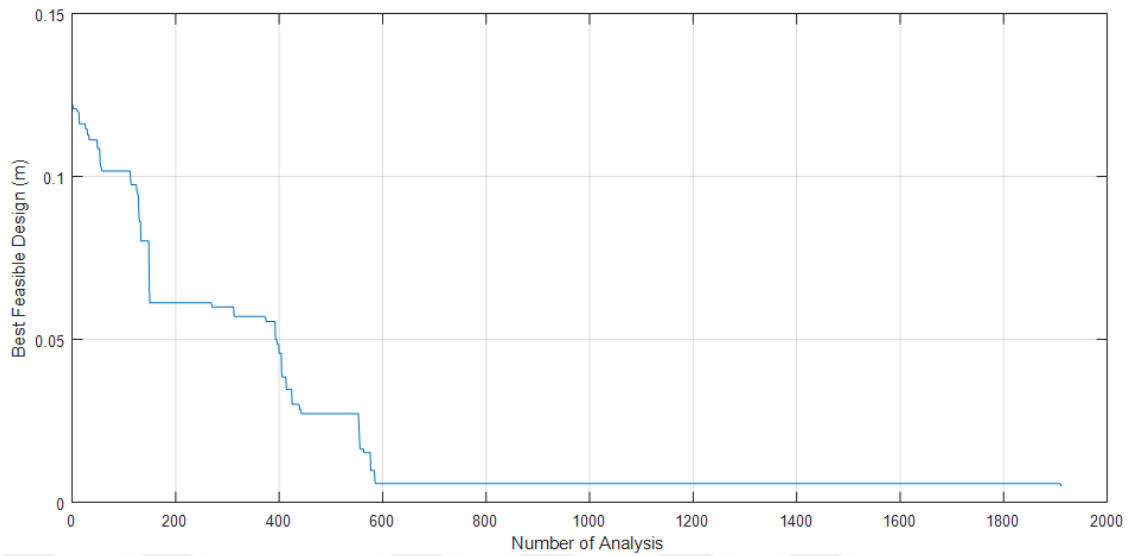

Figure 26 Best Feasible Design

The graph indicates that, best feasible design values are decreased gradually. When coming towards to the end of analysis, fitness value is reached equilibrium at 0.005 m which is a tolerable value. For the best feasible design having fitness value 0.0048, the parameters are backcalculated by the help of SA. The results are tabulated in Table 7.

Table 7 Observed Parameters - SA

Parameter	E (Mpa)	GSI	UCS (Mpa)	Ko
Final Solution	123.40	15.00	3.80	1.02

#### 4.4. Forward Calculation with Optimized Parameters

Parameters are gathered through back analysis platform and optimum parameters having the smallest fitness value, which is achieved by PSO, are presented in Table 8.

Table 8 Optimum Parameters

Parameter	E (Mpa)	GSI	UCS (Mpa)	Ko
Final Solution	199.90	15.00	3.50	0.94

When the parameters are fed to the PLAXIS, the final deformations can be obtained as in the shaded deformation output in Figure 27.

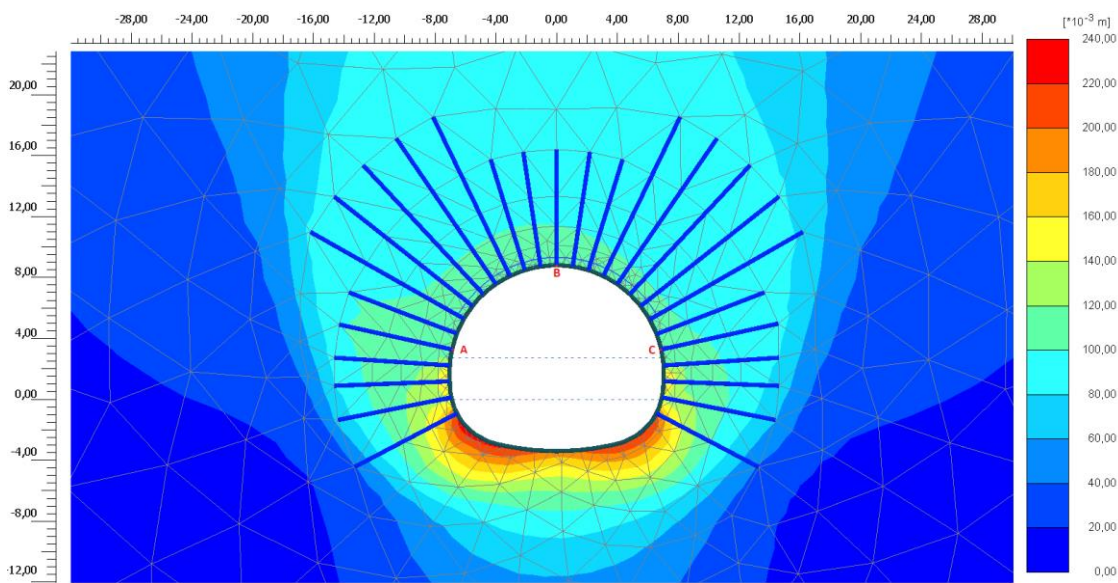

Figure 27 Deformation Shadings Around the Tunnel

At the field measured points A, B and C deformations are forwardly calculated. Field measured deformations, FEM deformations and the normalized error is calculated and tabulated in following Table 9.

Table 9 Measured, Backcalculated, Pre-estimated Deformations



READING POINT	MEASURED DEFORMATIONS (mm)	BACKCALCULATED DEFORMATIONS (mm)	PRE-ESTIMATED DEFORMATIONS (mm)
A	110	108	30
B	102	102	50
C	101	104	40

For the best feasible design, parameters are backcalculated with the help of back analysis platform and the results are compared with the parameters that were pre-estimated with the help of laboratory results during the design phase of the T26 tunnel. Both parameter set is tabulated in Table 12

Table 10 Backcalculated Parameters and Pre-estimated Parameters

Parameters	E (Mpa)	GSI	UCS (Mpa)	Ko
Backcalculated Parameters	199.90	15.00	3.50	0.94
Pre-Estimated Parameters	280.00	20.00	25.00	0.50

During the design phase, deformation values are gathered from the numerical model of T26 tunnel with the preestimated parameters. The foreseen displacements and measured displacements during the construction are in Table 9.

The deformation tolerance of the designed tunnel section is determined as 30 cm for the classified C3 type of rock, as concerning the quality of the rock mass. Calculated deformations by means of numerical modeling with respect to the pre-estimated parameters during the designing stage of the project is misleading for the specific

section of tunnel according to the field-deformations. Pre-estimated deformations are calculated for a long range of tunnel section; from Km:216+260 – km:220+300 in which the rock mass is idealized with respect to the few boreholes and limited laboratory results.

#### **4.5. Results & Discussion**

Underground excavations are relatively complex problems in geotechnical engineering with various unknowns due to the subsurface conditions. The complexity of the problem makes the back analysis difficult since multiple minima may exist in the search domain of the problem. In this chapter, with the embedment of field measurements and using the finite element model, the back analysis platform developed to inversely calculate the soil and rock mass properties around the tunnel was used to analyze the geotechnical characteristics surrounding rock mass Ankara-Istanbul T26 railway tunnel. As mentioned in the development stages of back analysis platform, both Simulated Annealing (SA) and Particle Swarm Optimization (PSO) algorithms were effectively coupled with 2D plane-strain finite element model to deal with a non-linear features of the tunneling problem to minimize the objective function which was simply defined as L2 norm of the displacement error at the specified coordinates.

Minimizing the objective function was achieved through both PSO and SA, which are stochastic through its nature. Both optimization algorithms showed similar performances. The fitness function was calculated to be 3.7 mm- 4.8 mm, respectively, which can be considered as quite a feasible design due to the fact that reading error for field-measurement is on the order of 5 mm. In short, the fitness value below 0.01 m is considered to be feasible and the gathered values are quite below this threshold.

The success of the back analysis platform is deeply dependent on assessing the degree of analogy between the physical and numerical model. The rock mass behavior and the three-dimensional effects are incorporated into the two-dimensional analysis by following a controlled relaxation factor. In order to simulate the initial relaxation of the rock mass, the excavation and the activation of the support elements did not take place in the same phase. First, the rock mass was let to relax in the excavation phase and then in the following step, the support elements were activated for a better simulation of the construction. The same construction sequence was followed for top-heading, bench and invert excavation.

The case study of T26 tunnel showed that, the results obtained from the back analysis platform are feasible in terms of evaluation of fitness; however, concerning the execution time, which takes about 12-15 hours to complete a full-run, can be regarded as a drawback. Still the duration of the analysis is acceptable considering the value of the gatherings. The execution time can be decreased by either modifying the optimization algorithms or simplifying the finite element model. One cycle of the back analysis platform runs the FEM approximately 2000 times to reach a feasible fitness value, therefore simplifying the FEM directly affect the calculation time. For example, if the the ground mass properties, and in-situ stresses are symmetrical to the vertical tunnel axis, by taking the advantage of symmetry, only half of the continuum can be analyzed, which decreases the runtime of back analysis platform dramatically.

During the design stage of the project, the rock mass parameters are idealized with respect to the site investigations and laboratory results. However, dividing the tunnel into long range of sections may be misleading especially for portal sections, since shallow overburden reduces the arching effect and increases the stresses as compared to deep tunnels. As can be seen from the calculated displacements during the design stage and field measured displacements in Table 11, although the foreseen deformations are proved for the overall behavior of the tunnel in advancing sections, the deformations are almost 50% different than the ones occurring in portal section.

This is due to lack of information of rock mass and idealizing the long range of tunnel as together. For these reasons, the backcalculated parameters from the field measurements are contrasting with the design parameters.



## CHAPTER 5

### RESULTS AND DISCUSSION

#### 5.1. Summary

This study aims to gather the material properties of soil and rock mass around the tunnel through the developing a back analysis platform specifically created for tunnels monitored regularly. The back analysis environment consists of three main components: (i) numerical modeling of tunnels, (ii) a metaheuristics based optimization scheme, (iii) matching of deformations obtained through tunnel monitoring with the numerical modeling. For the numerical modeling of tunnels, one of the most widely used numerical program called PLAXIS was utilized in two-dimensional plane-strain settings. Two metaheuristics based optimization schemes chosen to minimize the difference of the measured data and computed data were Particle Swarm Optimization (PSO) and Simulated Annealing (SA). The integration of the optimization algorithms to the finite element software was performed through Python programming language.

The developed platform was then applied to obtain the geotechnical parameters of a tunnel constructed in the scope of Ankara-İstanbul High-Speed Railway Project. Once, the field measured data were gathered from the construction site and the measured section is modeled numerically with the same construction scenario. Afterward, with the help of back analysis platform, the material properties around the tunnel are obtained explicitly.

## 5.2. Findings of the Study

The use of metaheuristic optimization algorithms in the developed back analysis platform does not guarantee a precise solution. The optimality and reliability of the solution depend on several conditions. First, the numerical model should represent the soil behavior around the tunnel. Second, the construction scenario is also very important in terms of redistribution of stresses around the tunnel section. Third, finite element mesh should be fine enough to capture the boundary conditions of the project site. Therefore, it is responsibility of the engineer, to study the specific problem and reach an agreement between the numerical model and construction scenario before carrying out the backcalculation analysis.

The performance of the back analysis platform relies on the deformation readings during construction of tunnels. Optimization algorithms try to reach these deformation values by altering the material parameters iteratively to match the monitored data. Therefore, the reliability of the data is very important in this manner. If the monitoring data did not take correctly recorded then the inverse calculations result in the erroneous set of parameters.

It was experienced during the study that, PSO and SA algorithms are very powerful and efficient global optimization techniques. To compare, both algorithms approached the optimal solution such that the fitness value of both algorithms is very similar and small enough to be accepted. Although the fitness values of both algorithms are similar and considered as feasible, due to the non-linearity of the problem and the impact of parameters on the strength of the rock mass varies, SA and PSO algorithms provided a relatively different set of parameters. Moreover, PSO provided slightly better performance in finding the lowest fitness value. Also, some parameters were found lower than the laboratory results for the closest borehole. This can be due to the measurements error or the change in the geology and hence material properties from the point that laboratory results were taken.

The performance of developed back analysis platform is tested through a case study Ankara-İstanbul high-speed railway project, T26 tunnel which is bored in weathered graphite-schist. During the design stage of the project, the rock mass parameters classified with respect to the site investigations and laboratory results. Under the light of these findings, tunnel alignment was divided into several sections according to the geology and overburden height. Constitutive models were generated for predetermined sections and support system is determined accordingly. Although the foreseen deformations are proved for the overall behavior of the tunnel in advancing sections, the deformations are almost 50% misleading for the portal section. This is due to lack of information of rock mass and idealizing the long range of tunnel as together. For these reasons, the backcalculated parameters from the field measurements are contrasting with the design parameters for the measured section.

The case study of T26 tunnel showed that, the results obtained from the back analysis platform are feasible in terms of fitness value evaluation; however, as concerning the execution time, which takes 12-15 hours to complete a full-run, can be regarded as a drawback of the platform. Still the duration of the analysis is acceptable considering the value of the gatherings. The execution time can be decreased by either modifying the optimization algorithms or simplifying the finite element model. One cycle of the back analysis platform runs the FEM approximately 2000 times to reach a feasible fitness value, therefore simplifying the FEM directly affect the calculation time.

Although the implemented version of SA was the standard form of the algorithm, the method has shown good results in the case study. The change of acceptance probability and the number of iteration the cooling cycles give the opportunity to widely searching the solution space at the beginning of the algorithm then by decreasing the acceptance probability and increasing the iteration number, the algorithm concentrates on the search the targeted global minimum in a relatively narrowed space. This process decreases the chance of trapping into a local minimum solution. Other metaheuristic algorithm, PSO is also a very efficient global

optimizations approach. The individual solutions, called particles, interact with each other in their neighborhood by recording the personal best and global best data and change their velocity vector with respect to this information. It was demonstrated that the PSO algorithm provided similar and slightly better performance than SA.

Parameter back analysis platform that was developed under favor of this study, can be easily applied to tunnel problems by changing the field conditions and getting use of the measured displacement during construction. The platform was established in such a way that it can be easily used by engineers and practitioners for tunnels. Moreover, the platform can be modified to be used for other geotechnical problems i.e., soil or rock slope stability, deep excavations or foundation problems. With the help of backcalculated parameters, geotechnical constructions can be revised to be more economical and safe.

### **5.3. Future Work**

The primary target of this study was to establish a platform that can reliably backcalculate the material properties from the field measurements using different metaheuristics based optimization algorithms. Whether the developed environment uses the appropriate method or not generally depends on the reliability of the field measured data and an appropriate numerical model that can accurately represent the tunnel and behavior of the rock mass around it. Although the proposed back analysis tool captured the field properties reliably to a certain extent, following points can still be improved for the further studies:

- The execution time of the back analysis platform depends on the complexity of the numerical model and the efficiency of the optimization algorithm. For the future studies, various enhancements and modifications can be done into the platform to improve its efficiency. In this sense, first, the finite element model can be replaced by its machine learning based surrogates that can



perform the same type of numerical analyses reliably. For this purpose, well-known machine learning methods such as “Artificial Neural Network (ANN)” or “Support Vector Machines (SVMs)” can be trained using the synthetic data obtained from finite element analyses, they can be used to obtain the deformations when the proper inputs are provided. The major advantage of having such an approach is that the properly trained surrogate models can replace the finite element analysis with only a small amount of error, within a relatively small amount of time.

- The most important factor for a tunnel design is the time between excavation of the face and the installation of the support elements. This phenomenon is incorporated into the two-dimensional analyses by following a controlled relaxation factor. A three-dimensional analysis could be performed to represent the longitudinal effects more precisely; however, execution of the three-dimensional model would be computationally expensive and would require an excessive amount of computation time to run as an iterative backcalculation procedure as compared to a two-dimensional model. In the tunnel case examined here, two-dimensional plane-strain models were used for quick solution times. The same back analysis platform can be applied to a three-dimensional model. In three-dimensional modeling, the displacement measurements can also be gathered in longitudinal direction and these measurements can also be employed in objective function for more precise information.
- Within the scope of this work, the most affected four parameters; elastic modulus (E), geological strength index (GSI), uniaxial compression strength (UCS) and Coefficient of Earth Pressure ( $K_0$ ) are backcalculated. For tunnel problems, if the laboratory results or site explorations are not satisfying other rock mass parameters such as; unit weight ( $\gamma$ ) Poisson ratio ( $\nu$ ) and rock mass parameter ( $m_i$ ) can also be backcalculated with advanced optimization

procedures. As the number of parameters increases, the complexity of the search space topology becomes more complex. In order to deal with this complexity, more advanced or modified global optimization methods can be used not to be trapped in a local minimum and approximating to the global optimum in the shortest way. Newly developed algorithms can be used such as Differential Evolution, Harmony Search or modified versions of Simulated Annealing algorithm etc.

- More case studies in different site conditions can be tested with the generated back analysis platform through this study.
- The field measurements used in this study are obtained through both a total station device and optical elements. Other recently introduced measurement techniques including laser scanners or measurements based on drones specifically developed for tunnels are kept out of this study and left for the future works.

## REFERENCES

- Alonso, E. E., Alejano, L. R., Varas, F., Fdez-Manin, G., Carranza-Torres, C., 2003. Ground response curves for rock masses exhibiting strain-softening behavior. *International Journal for Numerical and Analytical Methods in Geomechanics* 27, 1153-1185.
- Barton, N., Grimstad, E., 1993. Updating of the Q system for NMT. Proceedings, International Symposium on sprayed concrete-Modern use of wet mix sprayed concrete for underground support, Fagernes, Oslo, Norway, pp. 46-66.
- Barton, N., 2002a. Some New Q-value Correlations to Assist in Site Characterisation and Tunnel Design, *International Journal of Rock Mechanics and Mining Sciences*, Vol. 39, pp. 185-216.
- Bieniawski, Z.T., 1973. Engineering Classification on Jointed Rock Masses. *Trans. South African Inst. Civil Engineering*, Vol.15, pp. 335-344.
- Brown, E.T., Bray, J.W., Ladanyi, B. and Hoek, E. , 1983. Characteristic line calculations for rock tunnels. *J. Geotech. Engng. Div., ASCE* 109, 15-39.
- C. Zhang, H. Shao, and Y. Li, "Particle swarm optimisation for evolving neural networks," in Proceedings of IEEE Symposium on Systems, Man and Cybernetics (SIS-2003), Washington DC, USA., 2000, pp. 2487-2490.
- Cai, M., Kaiser, P.K., Uno, H., Tasaka, Y., Minami, M., 2004. Estimation of Rock Mass Deformation Modulus and Strength of Jointed Hard Rock Masses Using the GSI System, *International Journal of Rock Mechanics and Mining Sciences*, Vol. 41, pp. 3-19.
- Carranza-Torres, C., Fairhurst, C., 1999. The elasto-plastic response of underground excavations in rock masses that satisfy the Hoek-Brown failure criterion. *International Journal of Rock Mechanics and Mining Sciences* 36, 777-809.
- Cividini, A., Jurina, G., Gioda, G., 1981. Some aspects of characterization problems in geomechanics. *International Journal of Rock Mechanics and Mining Sciences* 18, 487-503.
- Chopman, D., Metje, N. and Stark, A., 2010, *Introduction to Tunnel Construction*, Spon Press, pp. 1-417.

- Dargush and Banerjee, 1989. G.F. Dargush, P.K. Banerjee The boundary element method for plane problems of thermoelasticity. *Int. J. Solids*
- Deere, D. U. (1964). *Technical Description of Rock Cores for Engineering Purpose, Rock Mechanics and Engineering Geology*, Vol. 1, No. 1, p. 17-22.
- Deng, D., Nguyen Minh, D., 2003. Identification of rock mass properties in elasto-plasticity. *Computers and Geotechnics* 30, 27-40.
- Doğan, E. and Saka, M., “Optimum Design of Unbraced Steel Frames to LRFD–AISC Using Particle Swarm Optimization”, *Advances in Engineering Software*, No. 46, pp 27–34, 2012.
- Dunnincliff, J., 1988. *Geotechnical instrumentation for monitoring field performance*, 1 edn. John Wiley and Sons, New York, 75-78, 199-295, 453-466.
- Dutro, H. B., 1989. Instrumentation. In: R. S. Sinha (Eds.) *Underground structures, design and instrumentation*, (1) Elsevier, Amsterdam, pp. 372-405.
- Finno RJ, Harahap IS. Finite element analyses of HDR-4 excavation. *Journal of Geotechnical and Geoenvironmental Engineering*, ASCE 1991; 117(10):1590-1609.
- Finno, R. J., & Calvello, M. (2005). Supported excavations: Observational method and inverse modeling. *Journal of Geotechnical and Geoenvironmental Engineering*, 131, 826-836.
- Gens, A., Ledesma, A., Alonso, E. E., 1996. Estimation of parameters in geotechnical backanalysis - II. Application to a tunnel excavation problem. *Computers and Geotechnics* 18 (1), 29-46.
- Gioda, G., 1985. Some remarks on back analysis and characterization problems. *Proceedings, 5th International Conference on Numerical Methods in Geomechanics*, Nagoya, Japan, 1-5 April, 1985, pp. 47-61.
- Gioda, G., Sakurai, S., 1987. Back analysis procedures for the interpretation of field measurements in geomechanics. *International Journal for Numerical and Analytical Methods in Geomechanics* 11, 555-583.
- Gnilsen R., *Underground Structures Design and Instrumentation* (ed. Sinha R.S.), 1989, Elsevier, Amsterdam, pp. 84-128

- H.L. Deng, G. Chen & Y.Guo, 2016 The Design and Implementation of Automatic Warning System of Tunnel Monitoring, pp. 420-445
- Hasançebi, O., & Erbatur, F. (2002a). Layout optimisation of trusses using simulated annealing. *Advances in Engineering Software*, 33(7-10), 681-696.
- Hasançebi, O., Çarbaş, S., & Saka, M. P. (2010a). Improving the performance of simulated annealing in structural optimization. *Structural and Multidisciplinary Optimization*, 41(2), 189-203.
- Hashash YMA, Whittle AJ. Ground movement prediction for deep excavations in soft clay. *Journal of Geotechnical and Geoenvironmental Engineering*, ASCE 1996; 122(6):474-486.
- Hashash, Y., Levasseur, S., Osouli, A., Finno, R., & Malecot, Y. (2010). Comparison of two inverse analysis techniques for learning deep excavation response. *Computers and Geotechnics*, 37, 323-333.
- Hoek, E., Carranza-Torres, C., Corkum, B., 2002. Hoek-Brown Failure Criterion – 2002 Edition, [http://www.rocsience.com/Hoek's Corner](http://www.rocsience.com/Hoek's%20Corner), last date accessed April 2004
- Hoek, E., Marinos, P. and Benissi, M., 1998. Applicability of the Geological Strength Index (GSI) classification for very weak and sheared rock masses. The case of the Athens Schist Formation. *Bull. Engg. Geol. Env.* 57(2), pp. 151-160.
- Hoek, E., (2003), "Numerical modelling for shallow tunnels in weak rock," *Rocscience*, .
- ISRM, 1981 Rock Characterisation, Testing and Monitoring ISRM Suggested Methods Pergamon, Oxford
- J. Kennedy and R.C. Eberhart. Particle Swarm Optimization. In *Proceedings of the IEEE International Joint Conference on Neural Networks*, pages 1942-1948, Piscataway, NJ, 1995. IEEE Press
- J. L. F. Martinez and E. G. Gonzalo. The generalized PSO: a new door to PSO evolution. *Artificial Evolution and Applications*, 2008:1–15, 2008.
- J. L. F. Martinez and E. G. Gonzalo. The PSO family: deduction, stochastic analysis and comparison. *Swarm Intelligence*, 3(4):245–273, 2009.

- Kirkpatrick, S., Gelatt, C. D., Vecchi, M. P., 1983. Optimization by simulated annealing. *Science* 220 (4598), 671-680.
- Kontogianni, V.A. and Stiros, S.C. 2003. Tunnel Monitoring during the excavation phase: 3-D Kinematic Analysis Based on Geodetic Data. Proceedings from 11th FIG Symposium on Deformation Measurements, Santorini, Greece, 2003.
- Kripakov, N.P., 1983, Finite element method of design: U.S. Department of Interior, Bureau of Mines, Denver, Colorado, 17 p.
- Ladanyi, B., 1974. Use of the log-term strength concept in the determination of ground pressure on tunnel lining: Proc. 3rd Cong. On Rock Mech., ISRM, v.11, Part B, Denver, Colorado.
- Langdon, W. B., Poli, R., Holland, O. and Krink, T., "Understanding Particle Swarm Optimization by Evolving Problem Landscapes", in Proceedings of the IEEE SwarmIntelligence Symposium, Pasadena, California, USA, pp.30–37, 8-10 June 2005.
- Ledesma, A., Gens, A., Alonso, E. E., 1996. Estimation of Parameters in Geotechnical Backanalysis - I. Maximum Likelihood Approach. *Computers and Geotechnics* 18 (1), 1-27.
- Leite, J. P., & Topping, B. H. (1998). Improved genetic operators for structural engineering optimization. *Advances in Engineering Software*, 29(7-9), 529-562.
- M. Clerc. *Particle Swarm Optimization*. iSTE, London, England, 2006.
- Metropolis, N., Rosenbluth, A., Rosenbluth, M., Telle, A., Teller, E., 1953. Equations of state calculations by fast computing machines. *Chemical Physics* 21, 1087-1092.
- Müller L. 1978. The reasons for unsuccessful applications of the New Austrian Tunnelling Method, Tunnelling Under Difficult Conditions, Proceedings of the International Tunnel Symposium, Tokyo, Pergamon Press, 67-72.
- NikolinakouM, Whittle A, Savidis S, Schran U. Prediction and Interpretation of the Performance of a Deep Excavation inBerlin Sand. *Journal of Geotechnical and Geoenvironmental Engineering*, ASCE 2011; 137(11):1047-1061.

- Peck, R. B., 1969. Deep excavation and tunneling in soft ground. Proceedings, 7th International Conference on Soil Mechanics and Foundation Engineering, Mexico City, pp. 225-290.
- Pekcan, O. (2010). "Soft Computing Based Parameter Identification in Pavements and Geomechanical Systems." Ph.D. thesis, University of Illinois at Urbana-Champaign.
- Peila, D., Oreste, P. P., 1995. Axisymmetric analysis of ground reinforcement in tunnel design. *Computers and Geotechnics* 17, 253-274.
- Perez, R. E. and Behdinan, K., " Particle Swarm Optimization in Structural Design", Chapter of "Swarm Intelligence: Focus on Ant and Particle Swarm Optimization", Book edited by: Felix T. S. Chan and Manoj Kumar Tiwari, ISBN 978-3-902613-09- 7, Itech Education and Publishing, Vienna, Austria, December 2007.
- Potts, D. M. and Zdravkovic, L. (1999). Finite element analysis in geotechnical engineering – theory. London, Great Britain: Thomas Telford, pp. 133-139.
- Pichler, B., Lackner, R., Mang, H. A., 2003. Back analysis of model parameters in geotechnical engineering by means of soft computing. *International Journal for numerical Methods in Engineering* 57, 1943-1978.
- Rabcewicz L. 1964. The New Austrian Tunnelling Method, Part one, *Water Power*, November 1964, 453-457, Part two, *Water Power*, December 1964, 511-515
- Rabcewicz, L., Golser, J. 1973. Principal of dimensioning the supporting system for the New Austrian Tunneling Method. *Water Power*, March, 88–93.
- Rocscience, 2002, "RocLab User's Guide", Rocscience Inc., Toronto, 25 pp.
- Roclab, 2007. <http://www.rocscience.com/products/Roclab.asp>
- S. Kirkpatrick, C. D. Gelatt, Jr., and M. P. Vecchi. Optimization by simulated annealing. *Science*, 220:671–680, 1983.
- Sakurai, S., 1978. Approximate time-dependent analysis of tunnel support structure considering progress of tunnel face. *International Journal for Numerical and Analytical Methods in Geomechanics* 2, 159-175.
- Sakurai, S., Takeuchi, K., 1983. Back analysis of measured displacements of tunnels. *Rock Mechanics and Rock Engineering* 16 (3), 173-180.

- Sial, (2011). Ankara-İstanbul Hızlı Tren Projesi Vezirhan-İnönü (Kesim 2) Tünel 26: Jeolojik- Jeoteknik Raporu ve Tünel Proje Raporu )KM-216+260- KM: 222+360) (Report No: EKD-T26-JER-001-U0)
- Singh, B. and Goel, R.K. 2006, Tunneling in weak rocks: Elsevier Geo-engineering Book Series, 489 p.
- Sinha, R.S. (1989). Underground Structures, Design and Instrumentation. Elsevier, pp. 1-546.
- Swoboda, G., Marence, M., Mader, I., 1994. Finite element modelling of tunnel excavation. International Journal of Engineering Modelling 6: 51–63.
- Terzaghi, K. (1946), “Rock Defects and Loads on Tunnel Support”, Rock Tunneling with Steel Supports, eds. R. V. Proctor and T. White, Commercial Shearing Co., Youngstown, Ohio, USA, pp. 15–99
- Vardakos, S., Gutierrez, M., 2007. Simplified parameter identification for circular tunnels. Tunelling and Underground Space Technology 21 (3-4), 372.
- Wang, C., Ma, G. W., Zhao, J., Soh, C. K., 2004. Identification of dynamic rock properties using a genetic algorithm. International Journal of Rock Mechanics and Mining Sciences 41 (3), 490-495.



## APPENDIX A

### CONSTRUCTION DETAILS

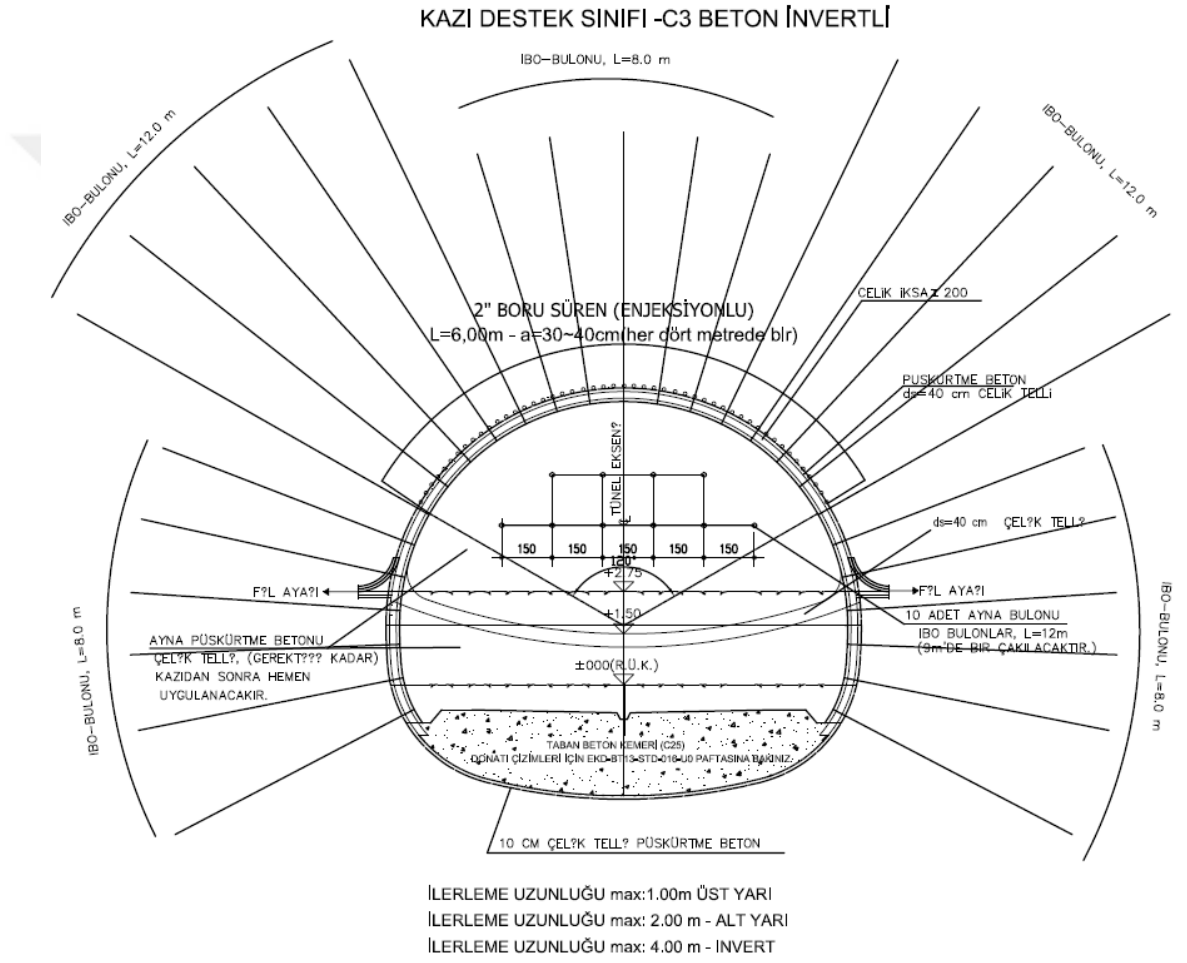
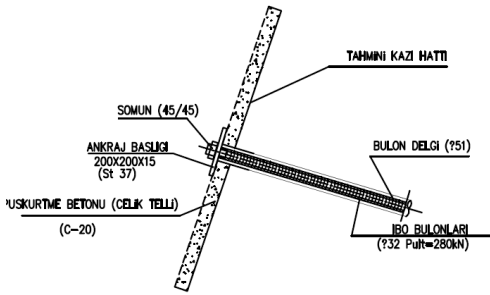
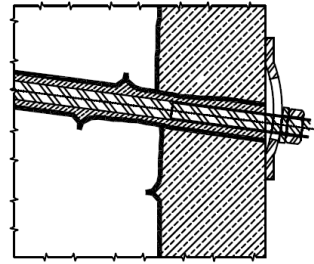
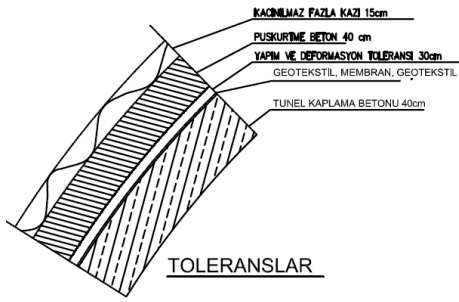
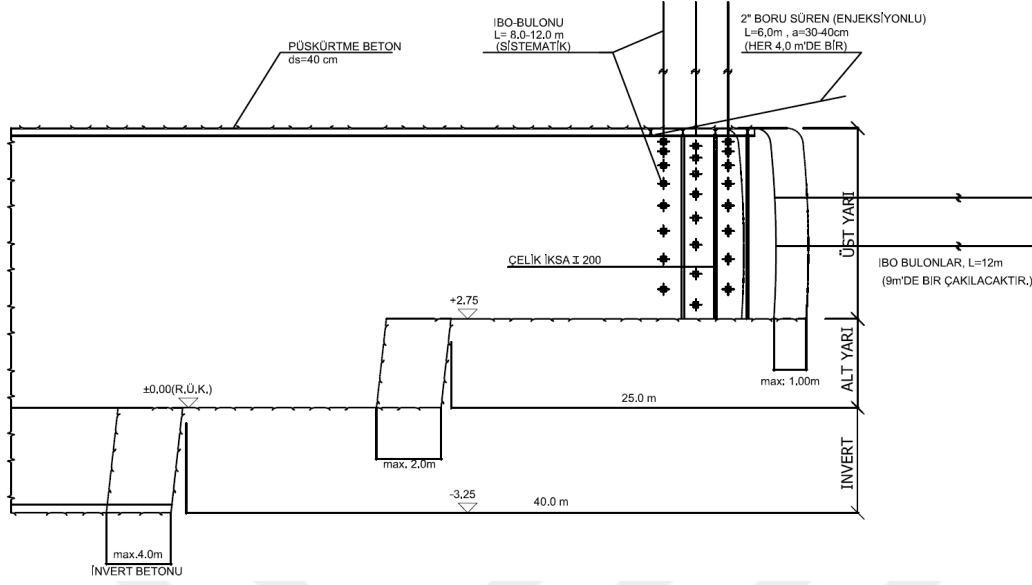
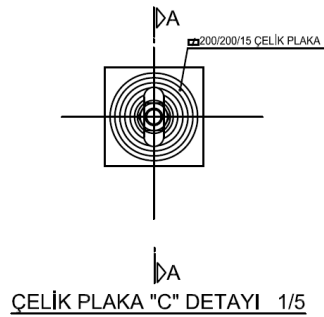

Figure 28 Construction Details A



İBO R32N BULON DETAYI



ÇELİK PLAKA "C" DETAYI 1/5

Figure 29 Construction Details B

## **APPENDIX B**

### **DEFORMATION MEASUREMENTS**





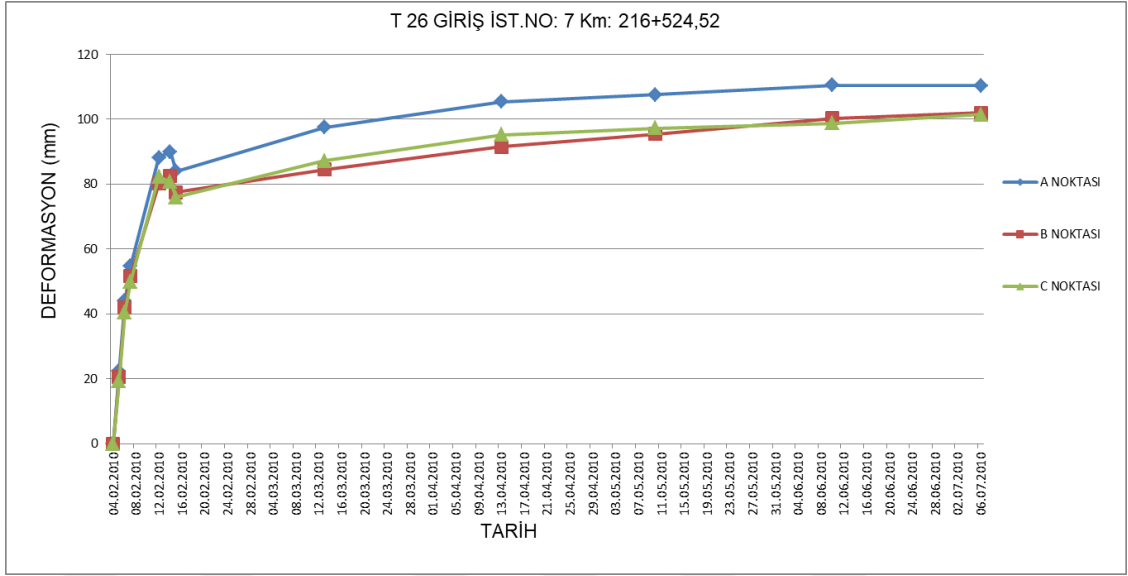

Figure 30 Deformation vs Date Graph