

**ROLE OF HEAT SHOCK PROTEINS IN TUMOR NECROSIS FACTOR-
INDUCED NUCLEAR FACTOR-kappaB SIGNALING PATHWAY**

by
MEHMET ALPER ARSLAN

Submitted to the Graduate School of Engineering and Natural Sciences
in partial fulfilment of
the requirements for the degree of
Master of Science

Sabanci University
August 2005

ROLE OF HEAT SHOCK PROTEINS IN TUMOR NECROSIS FACTOR-INDUCED
NUCLEAR FACTOR-kappaB SIGNALING PATHWAY

APPROVED BY:

Prof. Hüveyda Başağa

.....

Assist. Prof. Alpay Taralp

.....

Assist. Prof. Batu Erman

.....

DATE OF APPROVAL:

16.08.2005

© Mehmet Alper Arslan 2005

All rights reserved

To all *a priori* reasons of my existence,

ABSTRACT

Heat shock proteins are a group of proteins that play key roles in thermoregulation, signal transduction, cell cycle control, development and transcriptional regulation through their diverse functions in protein folding/refolding, protein translocation/shuttling, protein activity via stabilization and/or maturation to functionally-competent conformation and protein turnover.

In this study, the role of heat shock proteins in tumor necrosis factor-induced nuclear factor-kappaB signaling pathway was investigated. Endogenous heat shock protein 90 levels were found to increase significantly in a time-dependent manner starting from 15 minutes of tumor necrosis factor treatment in HeLa cell line, as shown by immunoblotting. Endogenous heat shock protein 70 levels were found to be unaffected by tumor necrosis factor in these cells. Accordingly, electrophoretic mobility shift assay results showed significantly impaired nuclear factor-kappaB activation in presence of the specific heat shock protein 90 inhibitor geldanamycin. These results indicate that heat shock protein 90 plays an important role in this signaling pathway.

To further search for any possible protein-protein interactions between components of this pathway and heat shock protein 90, transfection of HeLa cells was optimized with green fluorescent protein with 95% efficiency. Immunoprecipitation of endogenous heat shock protein 90 and transfected inhibitor-kappaB kinase alpha were also optimized with high efficiency as a prerequisite to co-immunoprecipitation assay. Work is in progress to show the interaction between these proteins by co-immunoprecipitation and to make use of this assay to search for any possible cross-talk between divergent downstream pathways of tumor necrosis factor signaling that might occur via heat shock protein 90.

ÖZET

Isı şoku proteinleri; protein katlanması ve yeniden katlanmasında, translokasyonu ve transportunda , işlevsel konformasyonda stabilizasyonu ile aktivitesinde ve yeniden dönüşümünde sahip olduğu çeşitli fonksiyonlarla termoregülasyon, sinyal iletimi, hücre bölünmesi kontrolü, gelişim ve transkripsiyonel regülasyonda anahtar roller oynayan bir grup proteindir.

Bu çalışmada ısı şoku proteinlerinin tümör nekroz faktörü tarafından indüklenen kappa-B nüklear faktörü sinyal iletim yolu üzerindeki rolü araştırılmıştır. İmmüno blotlama yöntemi ile HeLa hücre içi ısı şoku proteini 90 seviyesinin, tümör nekroz faktörü uygulaması ile 15 dakikadan başlayarak zamana bağımlı olarak önemli derecede artış gösterdiği saptanmıştır. Hücre içi ısı şoku proteini 70 seviyesinde tümör nekroz faktörü uygulaması ile herhangi bir değişiklik gözlemlenmemiştir. Bununla beraber, elektroforetik hareketliliği geciktirme metodu, spesifik ısı şoku proteini 90 inhibitörü geldanamisin varlığında, kappa-B nüklear faktörü aktivasyonunda önemli derecede düşüş olduğunu göstermiştir. Bu sonuçlar ısı şoku proteini 90'ın bu sinyal iletim yolunda önemli bir rolü olduğuna işaret etmektedir.

Isı şoku proteini 90 ile bu sinyal yolunda görev alan proteinler arasında muhtemel olabilecek interaksiyonları araştırmak için HeLa hücresi transfeksiyonu yeşil floresans proteini kullanılarak %95 verimlilikle optimize edilmiştir. İkili immünoçökeltme için gerekli olan hücre içi ısı şoku proteini 90'ın ve transfekte edilmiş kappaB inhibitörü alfa kinazın immünoçökeltme ile eldeleri de yüksek verimlilikle optimize edilmiştir. İkili immünoçökeltme ile bu proteinlerin interaksiyonunun gösterilmesi ve bu metodun, tümör nekroz faktörü sinyal yolunun birbirinden ayrılan alt sinyal yolları arasında gerçekleşen iletişimde ısı şoku proteini 90'ın muhtemel rolünü araştırmak için kullanılması çalışmaları halen devam etmektedir.

ACKNOWLEDGMENTS

I would like to thank my supervisor, Prof. Hüveyda Başağa, for her encouragement and unfading belief in me even during the hardest times of this project. Without her continual support and guidance, this project would not have been possible. The easing and joyful talks we had have been the driving force that kept me on working and helped me a lot to see the bright side of the things in an optimistic manner.

I would like to express my special thanks to Dr. Özgür Kütük, who contributed a lot for the establishment of this laboratory in the past. He has always been a good friend and a helpful researcher who never hesitates to share his knowledge with the ones in need.

Herein, I find the opportunity to thank all members of the Biological Sciences and Bioengineering Program for creating such a professional research environment where everyone trusts and respects one another. I would like to express my special thanks to Assist. Prof. Batu Erman and Assist. Prof. Alpay Taralp, who have critically read this work and contributed with their invaluable ideas.

I would like to thank all my friends in the graduate program, with whom I spent such a great time during these three years. Finally I would like to thank my family, for their endless support and understanding.

Thank you all who has made this work possible and whose names I could not mention here... Thank you.

TABLE OF CONTENTS

1. INTRODUCTION:	1
1.1. Heat Shock Protein 70 (HSP70)	2
1.1.1. Structure, Function and Regulation by Co-Chaperones	2
1.1.2. Hsp70 and Stress-Induced Apoptosis	5
1.1.3. Hsp70 and Stress-Activated Protein Kinase Signaling	10
1.1.4. Hsp70 and Death-Receptor (DR) Signaling	14
1.1.4.1. Fas/CD95-Induced Apoptosis	14
1.1.4.2. TNF-Induced Apoptosis	16
1.1.4.3. TNF-Induced Activation of JNK	18
1.1.4.4. Hsp70 and Ras/Raf-1 Signaling Pathway	21
1.2. Heat Shock Protein 90 (HSP90)	24
1.2.1. Structure and Function	24
1.2.2. Molecular Mechanism of Hsp90 Multichaperone Complex Function and Regulation by Co-Chaperones	28
1.2.3. Hsp90 and Signal Transduction	31
1.2.3.1. Geldanamycin and Proteasome-Mediated Degradation of Hsp90 Client Proteins	32
1.2.3.2. Signaling Pathways Associated with Hsp90	36
1.2.3.2.1. Ras/Raf-1 Signaling Pathway	36
1.2.3.2.2. Akt/PKB Signaling Pathway	37
1.2.3.2.2.1. Akt/PKB and TNF-Induced NF- κ B Signaling Pathway	38
1.2.3.2.2.2. Hsp90 and Akt/PKB Pathway	41
1.2.3.2.3. Apoptosis and Apaf-1	42
1.2.3.2.4. Heat-Shock Factor-1 (HSF-1)	42
1.2.3.2.5. TNF-Induced NF- κ B Signaling Pathway	43

2. PURPOSE.....	49
3. MATERIALS.....	50
3.1. Chemicals and Media.....	50
3.2. Kits.....	51
3.3. Antibodies.....	52
3.4. Enzymes.....	52
3.5. Cells.....	53
3.6. Vectors.....	53
3.7. Others.....	53
3.8. Equipment.....	54
4. METHODS.....	56
4.1. Cell Culture.....	56
4.1.1. Cryopreservation.....	56
4.2. Cell Treatments.....	57
4.3. Total Protein Extraction.....	58
4.4. Cytoplasmic/Nuclear Differential Protein Extraction.....	58
4.5. Protein Concentration Determination.....	59
4.6. Immunoblotting.....	59
4.6.1. SDS-PAGE.....	59
4.6.2. Wet-Transfer.....	60
4.6.3. Antibody Incubations.....	61
4.6.4. Detection.....	61
4.7. Immunoprecipitation.....	62
4.8. Electrophoretic Mobility Shift Assay.....	63
4.8.1. Preparation of Radiolabeled Oligonucleotide Probe.....	63
4.8.2. Binding Reaction.....	64
4.8.3. Vertical Gel Electrophoresis.....	65
4.8.4. Detection.....	66
4.9. Transfection of HeLa Cells by Electroporation.....	66
4.10. Transformation.....	67
4.11. Midi-Preparation of Plasmid DNA and Restriction Endonuclease Digestions.....	67
5. RESULTS.....	69
5.1. Endogenous Hsp90 and Hsp70 Profiles.....	69

5.2.	Analysis of NF- κ B Activation.....	71
5.2.1.	Control of NF- κ B Specificity and Identity.....	71
5.2.2.	Effect of Geldanamycin on TNF/IL-1-Induced NF- κ B Activation.....	73
5.2.3.	High Efficient HeLa Transfection.....	74
5.2.4.	Analysis of Protein-Protein Interaction.....	77
6.	DISCUSSION.....	80
7.	CONCLUSION.....	88
8.	REFERENCES.....	89

LIST OF FIGURES

Figure 1.1	Molecular structure of hsp70.....	3
Figure 1.2	Schematic representation of the domain structure and co-chaperone binding sites of hsp70.....	4
Figure 1.3	Switch between protein folding and protein degradation mediated by hsp70 is co-chaperone-dependent.....	5
Figure 1.4	Suppression of stress-induced apoptosis by heat shock proteins.....	9
Figure 1.5	Inhibition of stress-activated protein kinase (SAPK/JNK) signaling by hsp70.....	12
Figure 1.6	Simplified overview of regulation of apoptosis by heat shock proteins.....	14
Figure 1.7	Comparison of TNF-R1 and Fas/CD95 signaling.....	16
Figure 1.8	Survival and death pathways triggered by Complex I and Complex II of TNF signaling, respectively.....	17
Figure 1.9	TNF-induced activation of JNK and regulation by NF- κ B-dependent gene expression.....	20
Figure 1.10	Regulation of Ras/Raf-1 signaling by hsp70-Bag1.....	22
Figure 1.11	The late chaperone network of the eukaryotic cytosol.....	23
Figure 1.12	Schematic representation of the domain structure and co-chaperone binding sites of hsp90.....	25
Figure 1.13	N-terminal domain of yeast hsp90 complexed with ADP.....	25
Figure 1.14	Diagram displaying the molecular interactions of the N-terminal domain of hsp90 with ADP.....	26
Figure 1.15	Cartoon structure of the hsp90 middle domain (residues 273-525).....	27
Figure 1.16	Model of N-terminally dimerized hsp90 (residues 2-525) constructed from its structural fragments.....	27
Figure 1.17	Activation of steroid hormone receptor (SHR) by hsp90.....	29

Figure 1.18	Rate limiting step of hsp90 multichaperone complex.....	30
Figure 1.19	Rate limiting step of ATP turnover.....	31
Figure 1.20	A secondary structure cartoon of the crystal structure of the N-terminal hsp90 domain (ending at residue 215), complexed with geldanamycin....	33
Figure 1.21	Diagram displaying the molecular interactions of the N-terminal domain of hsp90 with geldanamycin.....	33
Figure 1.22	Chemical structures of GA and 17-AAG.....	34
Figure 1.23	A model for chaperone and co-chaperone interactions of Raf-1, describing its maturation, activation and inactivation.....	37
Figure 1.24	TNF-induced NF- κ B activation and cross-talk with Akt/PKB pathway...	39
Figure 1.25	Negative regulatory loop between NF- κ B and PTEN involved in the modulation of TNF-induced apoptosis.....	40
Figure 1.26	Inhibitory effects of geldanamycin (GA) at different stages through Akt/PKB signaling.....	41
Figure 1.27	The main physiological (indicated in green) and pathological (indicated in blue) effects linked to members of the TNF superfamily....	45
Figure 1.28	Schematic representation of the domain structures of NF- κ B/Rel family and I κ B proteins.....	46
Figure 1.29	Regulation of transcriptional activity of NF- κ B and negative feedback mechanism operated by I κ B α	47
Figure 1.30	Five classes of NF- κ B-driven target genes.....	48
Figure 5.1	Endogenous hsp90 protein levels under time-dependent TNF stimulation (20 ng/ml) (IB: hsp90).....	69
Figure 5.2	Endogenous hsp70 protein levels under time-dependent TNF stimulation (20 ng/ml) (IB: hsp70).....	70
Figure 5.3	Endogenous hsp70 protein levels under time-dependent IL-1 stimulation (20 ng/ml).....	70
Figure 5.4	Two sets of control experiments, confirming NF- κ B binding specificity and identity in EMSA.....	73
Figure 5.5	Effect of geldanamycin pretreatment (at 0.5 μ M for 15 hrs) on TNF-induced NF- κ B activation.....	73
Figure 5.6	Effect of geldanamycin pretreatment (at 0.5 μ M for 15 hrs) on IL-1-induced NF- κ B activation.....	74
Figure 5.7	View of GFP-transfected HeLa cells under fluorescence microscope.....	75

Figure 5.8 View taken from the same region as Figure 5.7 under visible light.....	76
Figure 5.9 FLAG-IKK α levels, confirmation of the efficiency of transfection (IB: FLAG).....	77
Figure 5.10 Immunoprecipitation of FLAG-IKK α from TNF-stimulated transfectant cells.....	78
Figure 5.11 Immunoprecipitation of endogenous hsp90 from TNF-stimulated cells.....	78
Figure 5.12 Immunoprecipitation of endogenous hsp90 from IL-1-stimulated cells.....	79
Figure 5.13 Co-immunoprecipitation of FLAG-IKK α and hsp90 from TNF-stimulated transfectant cells.....	79

ABBREVIATIONS

17-AAG:	17-allylamino-geldanamycin
ADP:	Adenosine diphosphate
Aha-1:	Activator of hsp90 ATPase-1
AIF:	Apoptosis inducing factor
Apaf-1:	Apoptotic protease-activating factor-1
ASK-1:	Apoptosis signal-regulating kinase-1
ATP:	Adenosine triphosphate
Bag-1:	Bcl-2 associated athanogene protein-1
Caspase:	Cysteinly aspartate-specific protease
CHIP:	C-terminus of hsp70-interacting protein
cIAP:	Cellular inhibitors of apoptosis
cPLA ₂	Cytosolic phospholipase A ₂
DISC:	Death-inducing signaling complex
DR:	Death receptor
EMSA:	Electrophoretic mobility shift assay
ERK1/2:	Extracellular signal-regulated kinase 1/2
FADD:	Fas-associated death domain
FAK:	Focal adhesion kinase
FasL:	Fas Ligand
FLIP:	FADD-like interleukin-1 β -converting enzyme (FLICE)-like inhibitory protein
GA:	Geldanamycin
GFP:	Green fluorescent protein
GRB-2	Growth factor receptor bound protein 2
GSK3:	Glycogen synthase kinase 3
Hip:	Hsp70-interacting protein

Hop:	Hsp70-hsp90 organizing protein
HSF-1:	Heat Shock Factor-1
HSP:	Heat shock protein
HSR:	Heat shock response
IB:	Immunoblotting
IKK:	Inhibitor κ B kinase
IL-1:	Interleukin 1
IP:	Immunoprecipitation
I κ B:	Inhibitor κ B
JNK:	c-jun N-terminal kinase
MAPK:	Mitogen activated protein kinase
MEFs:	Mouse embryonic fibroblasts
MKP1/3:	MAPK phosphatase 1/3
NEMO:	NF- κ B essential modulator
NF- κ B:	Nuclear factor- κ B
PARP:	Poly(ADP-ribose) polymerase
PDK1:	Phosphoinositide-dependent kinase-1
PI3K:	Phosphoinositide 3-kinase
PKB:	Protein kinase B
PKC:	Protein kinase C
PP2A:	Protein phosphatase 2A
PTEN:	Phosphatase-and-tension homologue deleted on chromosome ten
Rel:	Reticuloendotheliosis
RHD:	Rel homology domain
RIP:	Receptor interacting protein
ROS:	Reactive oxygen species
RTK:	Receptor tyrosine kinase
SAPK:	Stress-activated protein kinase
SODD:	Silencer of death domain
Sos:	Son-of-sevenless
sTNF:	Soluble tumor necrosis factor
TACE:	TNF alpha converting enzyme
tBid:	Truncated Bid

TNF-R1	Tumor necrosis factor receptor 1
TPR:	Tetratricopeptide repeat
TRADD:	TNF receptor-associated death domain
TRAF2:	TNF-R1-associated factor 2
Trx:	Thioredoxin
XIAP:	X-chromosome-linked IAP

1. INTRODUCTION

Heat shock proteins (hsps) are a group of proteins that have been implicated in various biological functions including response to heat shock [1] (known as **heat shock response-HSR**), oxidative stress, chemotherapeutic agents, UV irradiation [2] and cytokine cytotoxicity [3-5]. Under normal conditions, these proteins are constitutively expressed and play important roles in cell function that includes: (1) proper folding of the nascent polypeptides during translation (protein folding quality control in cytosol, endoplasmic reticulum and mitochondria), (2) facilitating protein translocation across various cellular compartments, (3) modulating protein activity by changing protein conformation, (4) promoting multiprotein complex assembly/disassembly, (5) refolding of misfolded proteins, (6) preventing protein aggregation and (7) targeting degradation of unstable proteins that can not be refolded productively [6, 7]. Under protein-damaging stress conditions, these proteins display essential roles in protecting cells from potentially lethal effects of cytotoxicity caused by misfolded/denatured proteins and/or protein aggregation, referred as “cytoprotective properties” of hsps [8]. It has been suggested that in accordance with their roles under normal and stress conditions, hsps may also play a crucial role in signal transduction by promoting folding or assembly/disassembly of signaling molecules as well as stabilizing active/inactive protein conformations [9].

Indeed, hsps are found to be overexpressed in various cancer cell lines and have been suggested as contributing factors in tumorigenesis due to their effect on protein conformation [10], as will be discussed later in detail. Oncogenic transformation is known to be the outcome of series of acquired mutations that lead to uncontrolled cell proliferation and suppressed cell death (apoptosis). Elevated hsp expression level is also shown to protect cells against apoptosis under protein-damaging conditions. Given their dual roles as determinants of protein conformation and stress condition, hsps are suggested to play key roles both in cell proliferation and apoptosis.

Three major members of hsp family include hsp90, hsp70 and hsp27. The canonical role of these proteins is either to (re)fold unfolded/heat-damaged/misfolded proteins to their native state or to target them for degradation if they are not refolded productively [11]. Following exposure to high temperature, cells restore back to their normal growth conditions and levels of cellular hsps remain elevated as an adaptational response to any possible subsequent stress condition. This phenomenon is known as “induced thermotolerance” [12]. The ultimate cell fate is dependent on the relative levels of hsps and damaged proteins. If hsps can handle the stress condition and can efficiently refold damaged proteins, with the aid of other survival signals, cells can escape apoptosis. At this stage, hsps help cells further to maintain survival by their antiapoptotic properties, as will be discussed later. However, if the amount of damaged proteins exceeds the refolding capacity of hsps present in the cell, with other apoptotic signals dominating over survival signals, decision to die is made. At this stage, it is not known whether the high level of hsps facilitates cell death. What is known is cell death can be triggered even under conditions in which as little as 5% of the total cellular protein content has undergone aggregation [13]. This striking example highlights the importance of hsps in determination of the cellular fate. In fact, it has recently been suggested that hsps might act as another checkpoint to prevent inappropriate early activation of apoptosis by their chaperoning ability to stabilize different conformational states-that is independent of their ability to refold misfolded/stress-damaged proteins.

1.1. Heat Shock Protein 70 (HSP70)

1.1.1. Structure, Function and Regulation by Co-Chaperones

Hsp70 is the most studied member of the chaperone family, responsible for productive folding of the unfolded polypeptides to their native state as well as refolding of the denatured proteins [14]. (Re)folding of substrate proteins to their native state is efficiently carried out by hsp70 via interactions between the substrate binding domain of hsp70 and the hydrophobic exposed stretches of the polypeptide substrates. Hsp70 intervention blocks any potential hydrophobic-hydrophobic interaction that might occur between these exposed aminoacids, preventing protein misfolding and irreversible

protein aggregation [6, 15]. The process of substrate binding and release is driven by ATPase activity of hsp70 and is essentially co-chaperone-dependent [16].

The ATPase domain (aminoacid residues 1-386) of the chaperone is localized to a 44 kDa N-terminal region, whereas the 18 kDa C-terminal region constitutes the substrate/peptide-binding domain (aminoacids 384-537). The 44 kDa ATPase domain consists of four subdomains forming two lobes with a deep cleft in-between as characterized by X-ray crystallography. The 18 kDa peptide binding domain consists of two four-stranded antiparallel β -sheets and a single α -helix, as determined by multidimensional nuclear magnetic resonance. The remaining 10 kDa C-terminal region of the protein (aminoacids 537-638) has an unknown function. C-terminus of the chaperone ends with four aminoacid sequence, EEVD, which is highly-conserved in all eukaryotic hsp70s. [17] (Figure 1.1)

The 44 kDa ATPase domain exerts an allosteric control over the 18 kDa peptide-binding domain: Only ADP-bound form of the chaperone induces the right conformational change in the C-terminal peptide-binding domain, opening the lid for the client protein to bind. A subsequent nucleotide exchange in the deep N-terminal cleft of the chaperone results in ATP binding in lieu of ADP, causing substrate release and the closure of the C-terminal lid. A new round of substrate binding will require ATP hydrolysis and the conformational change induced upon this hydrolysis [16-19].

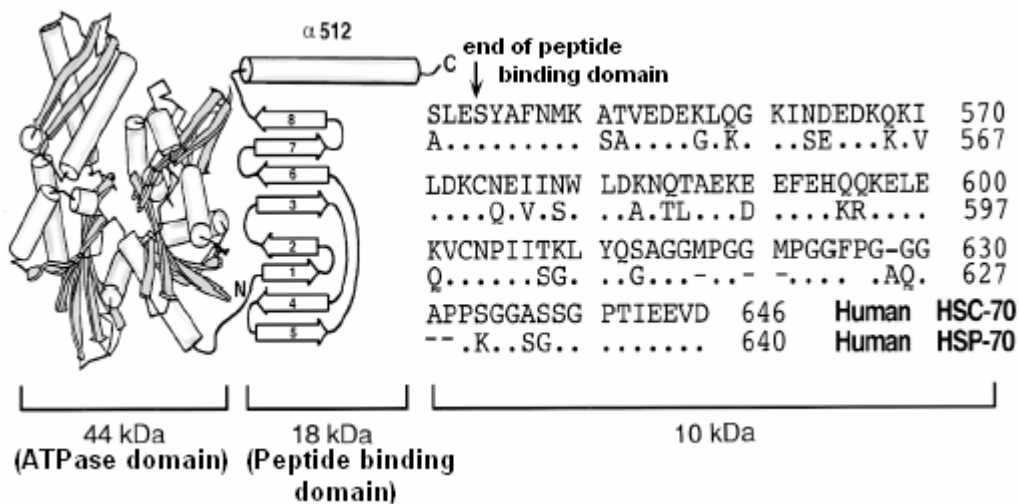

Figure 1.1 Molecular structure of hsp70. (modified from [17])

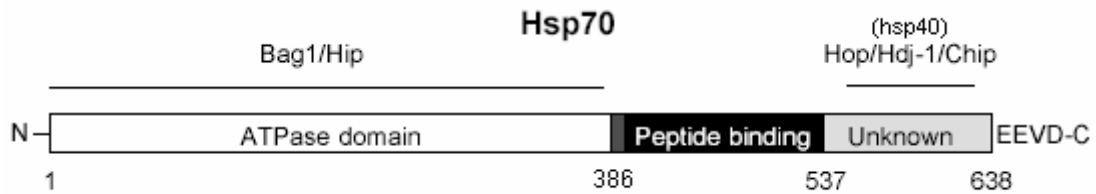

Figure 1.2 Schematic representation of the domain structure and co-chaperone binding sites of hsp70. (modified from [20])

Hsp70 activity is modulated by regulatory co-chaperones like C-terminus binding Hsp40 (Hdj-1), Hop and CHIP and N-terminus binding Hip and Bag1 (Figure 1.2). Hsp40 (Hdj-1) stimulates the ATPase activity when bound to C-terminal region of hsp70 and thus stabilizes the substrate-bound form [21, 22]. Hop and CHIP also bind to C-terminus and are both tetratricopeptide repeat (TPR) domain-containing proteins. Hop (**hsp70-hsp90 organizing protein**) couples hsp70 to hsp90 via association through the C-terminus of hsp90. Hop binding inhibits the ATPase activity of hsp90, stabilizing its interaction with client proteins [23, 24]. CHIP (**C-terminus of hsp70-interacting protein**) inhibits hsp40-stimulated ATPase activity of hsp70 and reduces its ability to refold denatured proteins [25]. Binding of these TPR containing co-chaperones to hsp70 requires the highly conserved C-terminal EEVD sequence. Deletion or single aminoacid substitution in this sequence leads to significant impairment in hsp70 substrate binding and completely destroys its refolding activity, thereby deregulating protection against heat shock. Hip and Bag1 are the only co-chaperones that bind to N-terminal ATPase domain of hsp70 and they directly compete to modulate hsp70 chaperone activity [26]. Hip (**Hsp70-interacting protein**) binding increases chaperone activity by stabilizing ADP-bound form [27], whereas Bag1 (**Bcl-2 associated athanogene protein**) acts as a negative regulator of hsp70 and inhibits its chaperone activity, accelerating nucleotide exchange in the N-terminal cleft that causes premature release of the unfolded protein substrate [28-31]. (Figure 1.3)

The significance of co-chaperones in regulating hsp70 activity in living cells has seriously been questioned on the basis of information provided from endogenous protein levels and stoichiometric analyses. The levels of Hip and Bag1 are well below hsp70 (approximately 1% of hsp70) and Bag1 affects hsp70 activity in a 1:1 molar ratio. This indicates that only a very limited amount of cellular hsp70 is influenced by a certain co-chaperone and in fact co-chaperones are unlikely to be the essential components of hsp70. [20]

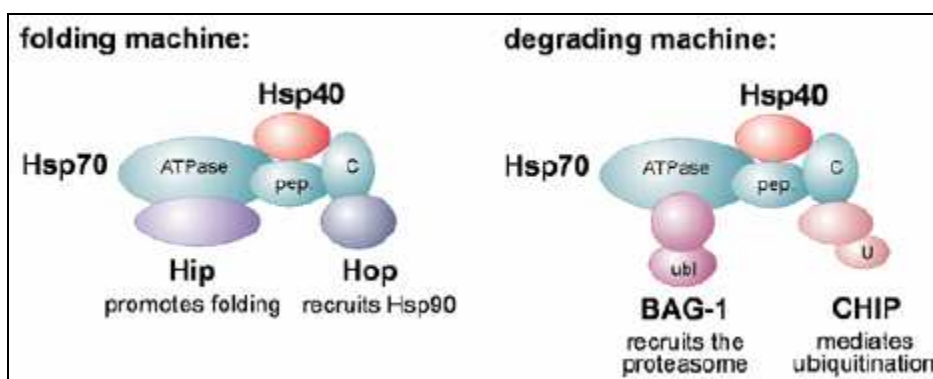

Figure 1.3 Switch between protein folding and protein degradation mediated by hsp70 is co-chaperone-dependent. Hip and Hop link hsp70 to folding machinery, whereas Bag1 and CHIP link hsp70 to degradation machinery, which will be discussed later under hsp90. (pep., peptide-binding domain of hsp70; ubl, ubiquitin-like domain; U, U-box) (adopted from [32])

Among all hsp70 co-chaperones, Bag1 has proven to be the most interesting one due to its additional involvement in apoptosis and signal transduction. Bag1 was initially identified as a Bcl-2-associated protein, playing role in Bcl-2 mediated inhibition of apoptosis [33]. Later, Bag1 has been shown to activate the serine/threonine MAP3Kinase Raf1, which is implicated in cell growth, via direct interaction [34]. Interestingly, hsp70 acts as an inhibitory factor for this interaction, sequestering all available Bag1 (Figure 1.10 and Figure 1.23). As will be discussed later, suppression of cell growth and division by hsps has possibly evolved as an adaptational response to stress-induced cellular damage since at these critical times, cells prefer to concentrate on reparation of damage rather than proliferate.(for review on Bag family proteins, see [35])

1.1.2. Hsp70 and Stress-Induced Apoptosis

Initially, hsps were thought to exert their cytoprotective effects only by suppression of heat-induced protein inactivation. Hsp70 overexpression protects cells from adverse effects of protein-damaging stresses [36]. Heat-induced inactivation of firefly luciferase is prevented and its reactivation following recovery from heat shock is enhanced by overexpression of hsp70 in mammalian cells. The ability of hsp70 to

protect firefly luciferase during heat shock even increased with the coexpression of co-chaperones hsp40 or Hip [26]. Although it is not clear how co-chaperones contribute to the cytoprotection provided by hsp70, it is suggested that their relative sufficient abundance is indispensable for activation of the full heat resistance. Overexpression of hsp70 alone in cells results in reduced resistance to heat shock when compared to thermotolerant cells that have been preconditioned by heat shock [36].

To investigate the individual contribution of hsp70 domains to the overall cytoprotective property of hsp70 under heat stress, mutational studies have been conducted with deleted proteins. Even though cells overexpressed with ATPase domain-deleted form of hsp70 show some level of heat resistance, they are much less effective in doing so than the full-length protein [37]. The case is similar with the heat-induced nuclear protein aggregation: ATPase-deleted hsp70 still reduces protein aggregation, yet less effectively than the full length protein [38]. The finding that ATPase-deleted form can still achieve some protection from heat stress has led to the suggestion that binding to misfolded proteins (with the still intact C-terminal peptide-binding domain) without refolding them is sufficient to provide resistance. Later, this suggestion has been questioned and to some extent supported by a new speculation brought up due to the nature of deletion mutant experiments. In this particular case, dominant-negative effect resulting from overexpression of ATPase-deleted hsp70 does not only refer to loss-of-function of chaperoning ability. Overexpressed ATPase-deleted protein saturates all endogenous C-terminus binding co-chaperones hsp40 and Hop, possibly causing a perturbation in the regulation of hsp70-mediated protein binding [19]. Thus, coexpression of such co-chaperones together with ATPase-deleted protein could best support the hypothesis of “insignificance of chaperoning ability of hsp70 in heat resistance or suppression of protein aggregation”. As mentioned above in the example of firefly luciferase, the exact role of co-chaperones in cytoprotection by hsps is not well-understood. Hence, this intriguing hypothesis has yet to be tested.

Subsequent studies have revealed that cytoprotective effects of hsps are not only restricted to suppression of heat-induced protein inactivation. The finding that thermotolerant cells are resistant to stress-induced apoptosis [39] has opened up a new area of research for better understanding specific roles of hsps in suppression of apoptotic death. Pioneering studies came in 1997, reporting overexpression of hsp70 alone can prevent stress-induced apoptosis [40, 41]. Suppression of apoptosis by hsp70 is blocked in heat-shocked cells when the ATPase domain is deleted, emphasizing the

necessity of chaperoning function of hsp70 in this process [42]. Likewise, deletion or substitution of the four highly-conserved C-terminal EEVD sequence leads to impaired suppression of apoptosis by hsp70, as a consequence of failure to block caspase (cysteinyl **aspartate-specific proteases**) activation [42].

Hsp70 is implicated in inhibition of apoptosis at multiple points [43]: upstream and downstream of cytochrome c release from mitochondria as well as upstream and downstream of caspase activation (Figure 1.4). Apoptotic events taking place at mitochondria and downstream of mitochondria, including caspase 9 and caspase 3, will be discussed in this section; whereas events taking place upstream of mitochondria including protein kinase signaling pathways such as ASK1—SEK1/MKK4 or MKK7—SAPK/JNK and Ras—Raf1—MEK1/2—ERK1/2 and death receptor signaling pathways such as Fas/CD95 and TNFR1, including caspase 8 and caspase 10, will be discussed in the following sections.

Overexpression of hsp70 in cells prevents proteolytic processing of initiator caspase 9 and executioner caspase 3, inhibiting their maturation into active cleaved caspases [40, 44]. This indicates antiapoptotic activity of hsp70 to be acting upstream of caspases. An *in vitro* study performed with purified hsp70 also showed that hsp70 was unable to prevent cleavage of **poly(ADP-ribose) polymerase (PARP)** by active caspase 3 [40]. (PARP, a nuclear DNA repair enzyme activated by DNA strand breaks, is a target of caspase 3 in the course of apoptosis) On the other hand, studies done with overexpressed active caspase 3 in cells revealed that hsp70 coexpression was sufficient to provide cytoprotection and maintain viability in these cells, indicating the involvement of hsp70 downstream of caspase 3, as well [45]. This is supported by the observation that hsp70 prevents cleavage of a caspase 3 target, **focal adhesion kinase (FAK)** via direct interaction with the target protein [46].

To investigate whether chaperoning function of hsp70 plays a role in the inhibition of pro-caspase processing, studies with ATPase domain-deleted protein have been conducted. The *in vitro* experiments performed by addition of ATPase-deleted hsp70 to cell free extracts showed that caspase 3 processing could be prevented as effectively as in the case with the full length protein [47]. However, as mentioned above, this appears to be insufficient for protection of cells from heat-induced apoptosis [42]. ATPase-deleted hsp70 can not rescue cells from apoptosis. These two findings together suggest that ATPase domain of hsp70 should have a different role in an alternative pathway independent of caspase 3 for suppression of apoptosis. This role

might be related with the executioner caspase 6, which is processed by caspase 9, as caspase 3. Chaperoning function of hsp70 alone might be the contributory factor for the inhibition of pro-caspase 6 processing by activated caspase 9, thereby providing another checkpoint for suppression of apoptosis, independently of caspase 3. This possibility has yet to be tested.

The influence of hsp70 can also be observed one step upstream of caspase 3 activation—that is namely “apoptosome formation”. Li et al. [47] have found that hsp70 overexpression does not prevent cytochrome c release from mitochondria but prevents caspase 3 activation, indicating that hsp70 is required for inhibition of apoptosis at some point downstream of cytochrome c release and upstream of caspase 3 activation. The point in-between harbors a well-characterized complex in the course of apoptosis called “apoptosome”, which is formed by ATP-dependent oligomerization of Apaf-1 (apoptotic protease-activating factor-1) upon cytochrome c binding, followed by recruitment of pro-caspase 9 [48]. This promotes the auto-processing of pro-caspase 9 into active cleaved caspase 9 [49]. [50, 51]

Soon, several other studies have been reported in support of the finding that hsp70 exerts its antiapoptotic effect via inhibition of apoptosome formation [52], by directly interacting with Apaf-1 through its ATPase domain and preventing the recruitment of pro-caspase 9 to the apoptosome [53]. This might be achieved by hsp70, either by inhibition of Apaf-1 oligomerization [52] or by hindrance of oligomerized Apaf-1 CARD domains that are responsible for pro-caspase 9 recruitment [53]. Beere et al. also showed that chaperoning activity of hsp70 is required for the inhibition of apoptosome formation. Mutation in C-terminal EEVD sequence of hsp70 restores functionally competent apoptosome formation and pro-caspase 9 processing *in vitro* [53]. (Figure 1.4)

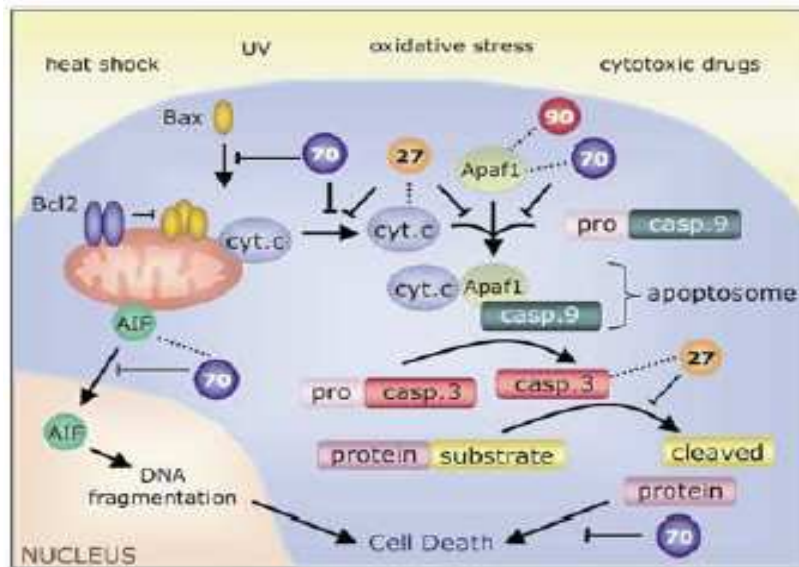

Figure 1.4 Suppression of stress-induced apoptosis by heat shock proteins. Dotted lines indicate interactions that have been demonstrated *in vitro*. (adopted from [19])

Antiapoptotic effects of hsp70 can be observed upstream of apoptosome formation, as well (Figure 1.4). In contradiction to the study by Li et al. [47] mentioned above, Mosser et al. have reported that overexpression of hsp70 prevents cytochrome c release from mitochondria [42]. Even though the precise mechanism of cytochrome c release remains unclear, this process is known to be regulated by the antagonistic members of Bcl-2 family [54]. This family includes pro-apoptotic proteins like Bax, Bak, Bid, Bad, Bik, Bim and anti-apoptotic proteins like Bcl-2 and Bcl-x_L. Homo/heterodimers formed between these proteins on the outer mitochondrial membrane determine the fate of mitochondrial transmembrane potential [55]. A pro-apoptotic signal dominating over an anti-apoptotic one results in generation of pores through the mitochondrial membrane, followed by loss of transmembrane potential and release of cytochrome c into cytosol. [50, 51, 56]

Bax has been shown to translocate to mitochondria to promote cytochrome c release in response to heat shock [57]. Hsp70 prevents this translocation, adding one more to its antiapoptotic effects [19]. Inhibition of Bax translocation is mediated by ATPase domain of hsp70, requiring the chaperoning activity. ATPase-deleted protein is unable to prevent Bax translocation and subsequent cytochrome c release. A supporting report [58] on inhibition of Bax translocation to mitochondria by hsp70 indicates

cooperation of hsp70 with its co-chaperone hsp40 (hdj-1), further emphasizing chaperoning and ATPase activities of hsp70 in this process. (Figure 1.4)

Cytochrome c is not the only apoptogenic/pro-apoptotic factor released from mitochondria into cytosol upon permeabilization of the outer mitochondrial membrane. The others include Smac/Diablo [59], EndoG, HtrA2/Omi, and AIF (apoptosis inducing factor) [56]. Among these, AIF is the most interesting and controversial one. When this factor was first discovered by Susin et al. [60] in 1999, it has been defined as a caspase-independent pro-apoptotic factor that translocates into nucleus to induce chromatin condensation and DNA degradation. Hsp70 directly binds to AIF after it is released from mitochondria and prevents its nuclear import [61], thereby neutralizing its death-inducing effect in *apaf-1*-null cells [62]. Only peptide-binding domain of hsp70 is required for interaction with AIF and for inhibition of AIF-induced apoptosis. ATPase domain of hsp70 is not needed [62]. However, recent studies tend to disprove the aforesaid notion of AIF as a caspase-independent apoptosis inducer, indicating that release of AIF from mitochondria *does* require caspase activation [63, 64]. This finding brings up the probability that hsp70 might indirectly inhibit the release of AIF from mitochondria via prevention of caspase activation [65]. This possibility has yet to be tested. [66, 67] (Figure 1.6)

1.1.3. Hsp70 and Stress-Activated Protein Kinase Signaling

Antiapoptotic properties of hsp70 are not only limited to suppression of cell death at or downstream of mitochondrial stage. Upstream of mitochondria, well-known signaling cascades comprised of members of the serine/threonine protein kinase family, namely MAPKs (**mitogen-activated protein kinases**), are activated by inflammatory cytokines or growth factors, as well as in response to various cellular stresses including heat shock, oxidative stress or UV irradiation [68]. Among them, SAPK/JNK (**stress-activated protein kinase/c-jun N-terminal kinase**) signaling pathway is one of the most related ones with hsps.

Hsp70 functions at multiple points as an antiapoptotic factor in the SAPK/JNK signaling cascade, which is implicated in apoptosis, as well as in cell growth and differentiation. Here, for my purposes, only pro-apoptotic effects of this pathway will be considered.

Membrane proximal kinases, MAP3Ks, of this pathway are known as MEKK1/4 or ASK1 (apoptosis signal-regulating kinase 1) [69, 70]. MEKK1/4 is activated by small GTPases of the Rho family, Rac and cdc42, in response to cellular stresses mentioned above. The other MAP3K, ASK1, can be directly activated in response to oxidative stress/reactive oxygen species (ROS) (see “TNF-induced activation of JNK”). However, there is an alternative death receptor Fas/CD95-induced pathway that can activate ASK1, as well. This alternative pathway and its association with hsp70 will be discussed in the next section. [71]

Activated MEKK1/4 and ASK1 phosphorylate and activate the MAP2Ks SEK1/MKK4 or MKK7, which in turn phosphorylate and activate the MAPKs SAPK/JNK [71] (Figure 1.5). It is noteworthy to mention here that JNK activation via TNF-R1 associated factor 2, TRAF2, is also possible upon TNF treatment. However, the consequence of TNF-induced JNK activation for TNF-mediated cellular responses is poorly understood, as will be discussed in the next section.

Pro-apoptotic effect of JNK signaling was first demonstrated in 1996 by two independent groups. Overexpression of a dominant-negative kinase mutant of SEK1/MKK4 or a phosphorylation-site mutated c-jun was found to block stress-induced apoptosis. Subsequent studies have implicated JNK in the release of cytochrome c [72] and Smac/Diablo [73] from mitochondria, as a consequence of JNK phosphorylation of Bcl-2 family members Bcl-2 [74, 75], Bcl-x_L [76], Bad [77] and Bim [78]. Phosphorylation neutralizes the anti-apoptotic activity of Bcl-2 and Bcl-x_L whereas it enhances the pro-apoptotic activity of Bad and Bim. Two extra targets of JNK phosphorylation are c-Myc [79] and p53 [80], both of which have been implicated in cytochrome c release from mitochondria [81, 82]. Under stress conditions, phosphorylation of the well-known tumor suppressor p53 by JNK prevents its ubiquitination and degradation, thereby promotes its stabilization and accumulation [80]. Elevated p53 levels exert a pro-apoptotic effect in cells via activation of Bax translocation to mitochondria [83]. (Figure 1.5)

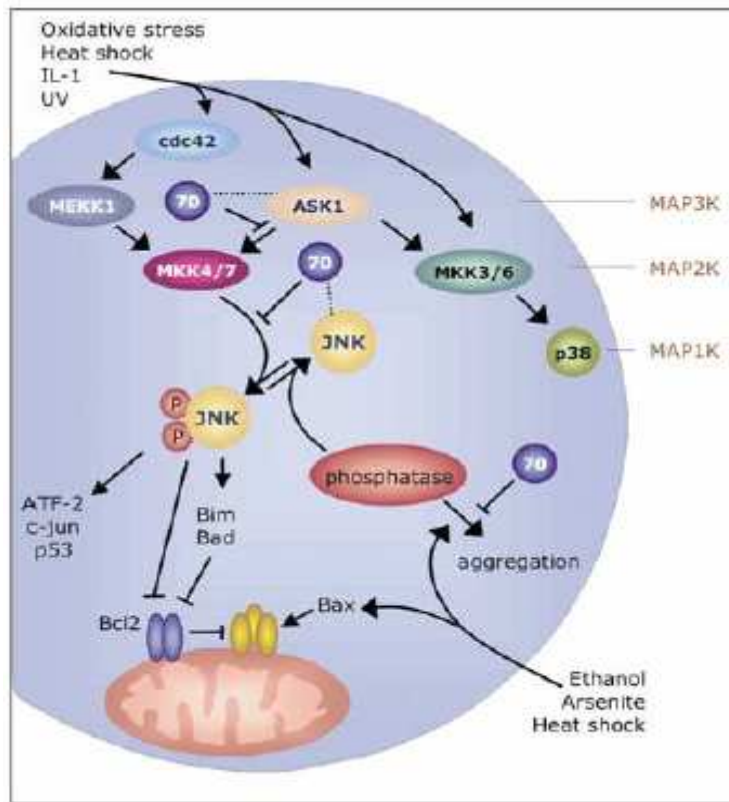

Figure 1.5 Inhibition of stress-activated protein kinase (SAPK/JNK) signaling by hsp70. Dotted lines indicate interactions that have been demonstrated *in vitro*. (adopted from [19])

JNK activation is potently inhibited by hsp70 in stressed cells through a variety of mechanisms. Heat shock activates JNK surprisingly without an increase in SEK1/MKK4 activity. The contributory factor for JNK activation, other than the basal level of SEK1/MKK4 activity, is a special JNK phosphatase. Heat shock inactivates this very heat-sensitive phosphatase, leading to its aggregation [84]. This shuts down the regulatory dephosphorylation of JNK by its phosphatase, causing accumulation of pro-apoptotic phosphorylated active JNK in cells [85]. However, overexpression of hsp70 prevents heat-induced inactivation of the JNK phosphatase, restoring the levels of dephosphorylated inactive JNK, which in turn helps suppression of heat-induced apoptosis [85]. Alternatively, hsp70 has also been shown to inhibit JNK activation by directly interacting with JNK and preventing its phosphorylation by SEK1/MKK4 [86]. Hsp70 overexpression blocked JNK activation and suppressed apoptosis, but had no effect on MEKK1 or SEK1/MKK4 activity both in UV-treated cells and in cells expressing constitutively active forms of MEKK1 or cdc42 [87]. The peptide-binding

domain of Hsp70 is required for binding to JNK-not the ATPase domain [88]. (Figure 1.5)

Another mechanism by which hsp70 ensures prevention of JNK activation operates upstream of JNK. The MAP3K of the pathway, ASK1 (see above), is inhibited by hsp70 via direct interaction [89]. In contrast to its interaction with JNK, ASK1 binding and kinase inhibition requires ATPase domain of Hsp70-not the peptide-binding domain. Cells expressing a constitutively active form of ASK1 were able to escape apoptosis with coexpression of the hsp70 ATPase domain alone. (Figure 1.5)

Here, it is important to note that the inhibitory effect of hsp70 on JNK activation is withdrawn when hsp70 is stably expressed in cells. (All of the reports up to here have been based on transient inducible overexpression of hsp70). Apart from apoptosis, JNK signaling also constitutes an essential part of cell growth and proliferation, as mentioned in the beginning of this section, via RTK (receptor tyrosine kinase)-mediated Ras activation. Prolonged inhibition of JNK by constitutive high-level expression of hsp70 is incompatible with cell growth. Therefore, the reason why JNK activation is re-established in stably hsp70-expressing cell lines may be attributed to adaptation of cells to grow even in the presence of high levels of hsp70. [19]

General simplified overview of heat shock protein effect on apoptosis:

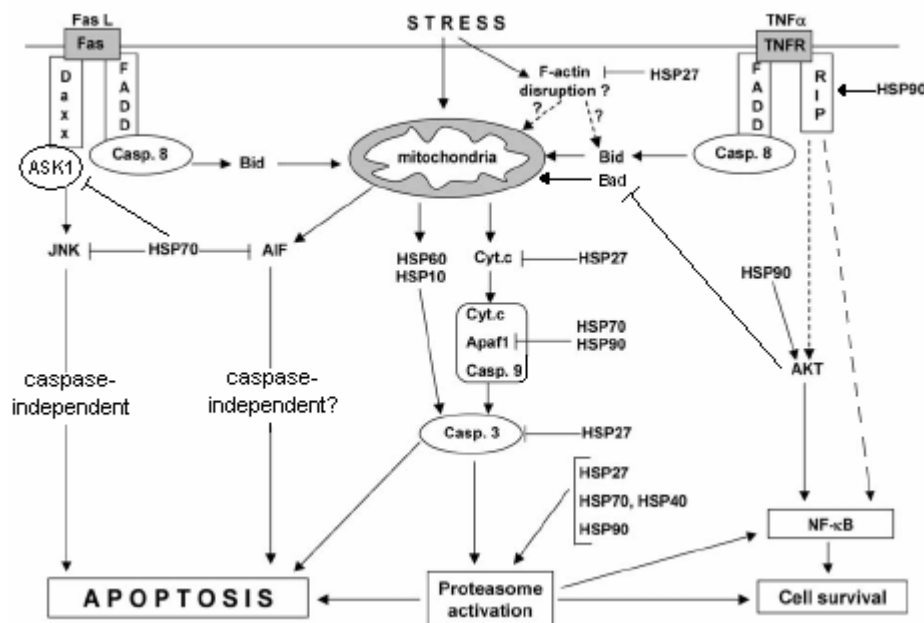

Figure 1.6 Simplified overview of regulation of apoptosis by heat shock proteins. (modified from [90]) (for two comprehensive reviews on heat shock proteins in the regulation of apoptosis, see [91] and [92])

1.1.4. Hsp70 and Death Receptor (DR) Signaling

Fas/Apo-1/CD95 and TNF-R1 are two most studied death domain-containing members of the tumor necrosis factor receptor (TNFR) superfamily.

1.1.4.1. Fas/CD95-Induced Apoptosis

Fas-induced apoptosis is initiated with Fas ligand (FasL)-stimulated trimerization of Fas, which triggers the formation of a death-inducing signaling complex (DISC). DISC contains the adaptor protein **Fas-associated death domain protein (FADD)** [93] and initiator caspases 8 [94] and 10. FasL-induced assembly of FADD and caspases 8 and 10 on Fas results in autoproteolytic processing of these caspases by induced proximity. Consequentially, cleaved active caspase 8 promotes apoptosis via two parallel cascades [95]: either it directly cleaves and activates executioner caspase 3 or it cleaves the pro-apoptotic Bcl-2 family protein, Bid [96]. Truncated Bid (tBid) then translocates to mitochondria, inducing cytochrome c [97] (and Smac/Diablo [59]) release in a Bax/Bak-dependent manner [98, 99], which sequentially drives the formation of apoptosome and activates caspase 9 and 3, as mentioned before [48, 49]. Fas-DISC is negatively regulated by **FADD-like interleukin-1 β -converting enzyme (FLICE)-like inhibitory protein, FLIP**, which integrates into DISC to prevent autoproteolytic processing of caspase 8. [50, 100] (Figure 1.6 and Figure 1.7)

Although Fas-induced apoptosis characteristically involves FADD and caspase 8, an alternative pathway integrates Daxx in lieu of FADD as the adaptor protein, which leads to activation of ASK1, the MAP3K of SAPK/JNK pathway [101]. In this case, ASK1 leads to activation of JNK and therefore apoptosis [102], via the other MAP2K, MKK7—not MKK4/SEK1 (see above). As mentioned in the previous section, this ASK1-induced apoptosis is essentially through mitochondria-dependent (neutralization of Bcl-2, etc.) caspase activation [70]. However, even though the mechanism is not well

understood, a kinase-independent function of ASK1 has been reported in caspase-independent cell death, as well [103]. As a negative regulator of ASK1 via direct interaction and inhibition [89], hsp70 appears to suppress both caspase-dependent and caspase-independent [104] cell deaths mediated by Fas—Daxx—ASK1 pathway. In support of the involvement of hsp70 in caspase-independent cell death, Nylandsted et al. [105] have reported that depletion of hsp70 by antisense technology activates a form of cell death, characterized by morphology consistent with apoptosis, which is remarkably *not* sensitive to caspase inhibitors or antagonizing effects of Bcl-2 and Bcl-x_L. (Figure 1.6)

Some other studies seem to contradict the above findings, demonstrating that overexpression of hsp70 does not protect cells from Fas-induced apoptosis [106]. Tran et al. [107] showed that exposure to a mild heat stress sensitized cells to Fas-mediated apoptosis, which was not due to altered JNK or ERK activities. Surprisingly, hsp70 induction following heat shock could not rescue cells from being sensitized to Fas-mediated apoptosis. Rather, sensitization was due to heat-induced downregulation of FLIP [107], which promoted caspase 8 cleavage without triggering cell death (caspases 9 and 3 were not cleaved). This is in accordance with the previous report that although it inhibits apoptosome formation, hsp70 does not prevent Fas-mediated apoptosis [53]. Discrepancies observed in regard to hsp70 role in Fas-induced cell death may be due to different downstream pathways employed by Fas/CD95 to promote apoptosis.

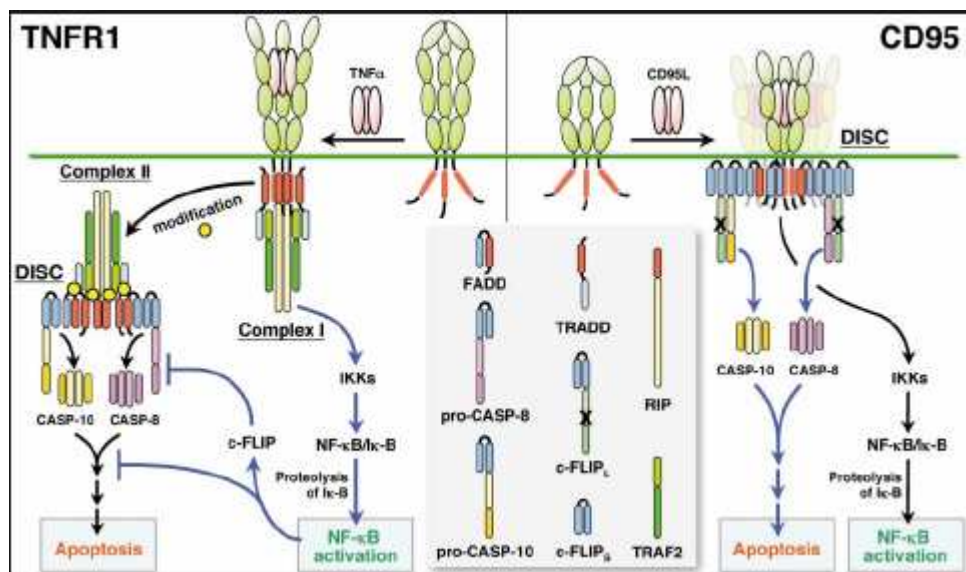

Figure 1.7 Comparison of TNF-R1 and Fas/CD95 signaling. Dark blue bold lines indicate the default pathways, which are survival for TNF-R1 and apoptosis for Fas/CD95. (adopted from [108])

1.1.4.2. TNF-Induced Apoptosis

TNF-R1-mediated apoptosis is even more complicated and less understood than Fas-mediated apoptosis. TNF, a homotrimer primarily produced by activated macrophages [109], binds to extracellular domains of preassembled TNF-R1 complexes [110], driving their rapid trimerization, which in turn causes the release of the inhibitory protein silencer of death domain (SODD) [111] from TNF-R1's intracellular death domain [112]. Then, the adaptor protein TNF receptor-associated death domain (TRADD) is recruited to TNF-R1 by homophilic interactions of the death domains [113]. Subsequently, TNF-R1-bound TRADD recruits both the adaptor protein TRAF2 [114] and the death domain containing serine-threonine kinase RIP (receptor-interacting protein [115, 116]), all of which assemble together "Complex I". Complex I triggers the NF- κ B survival pathway via recruitment of the IKK (Inhibitor κ B kinase) complex [117], whereas JNK is activated via TRAF2-mediated [118, 119] activation of MAP3Ks, ASK1 [120] and MEKK1 [121, 122]. [123, 124]

Nuclear factor- κ B (NF- κ B) plays an important role in the regulation of TNF-R1-mediated apoptosis [125], by transcriptionally activating its antiapoptotic target genes such as *cIAPs* [126, 127] and *FLIP* [128, 129]. FLIP, as mentioned before, blocks autoproteolytic processing of caspase 8; whereas cIAPs (inhibitors of apoptosis) act as E3 ubiquitin ligases, targeting caspases 3, 7 and 9 for proteasomal degradation [130-132]. cIAP1 and cIAP2 are recruited to TNF-R1 by TRAF2 as a part of Complex I [133]. Following stimulation by TNF, some components of Complex I are posttranslationally modified by yet an unknown mechanism. This modification causes dissociation of TRADD-RIP-TRAF2 from TNF-R1. The liberated death domain of TRADD now binds to FADD in cytosol [114], which recruits caspase 8 and 10, resulting in the formation of an intracellular DISC, "Complex II". Signaling cascade leading to apoptosis after the formation of DISC is the same as mentioned above in Fas/CD95-induced apoptosis. (Apoptogenic factor Smac/Diablo released from mitochondria can antagonize the caspase inhibitors cIAPs [134, 135] and block their association with TRAF2.) (Figure 1.7 and Figure 1.8)

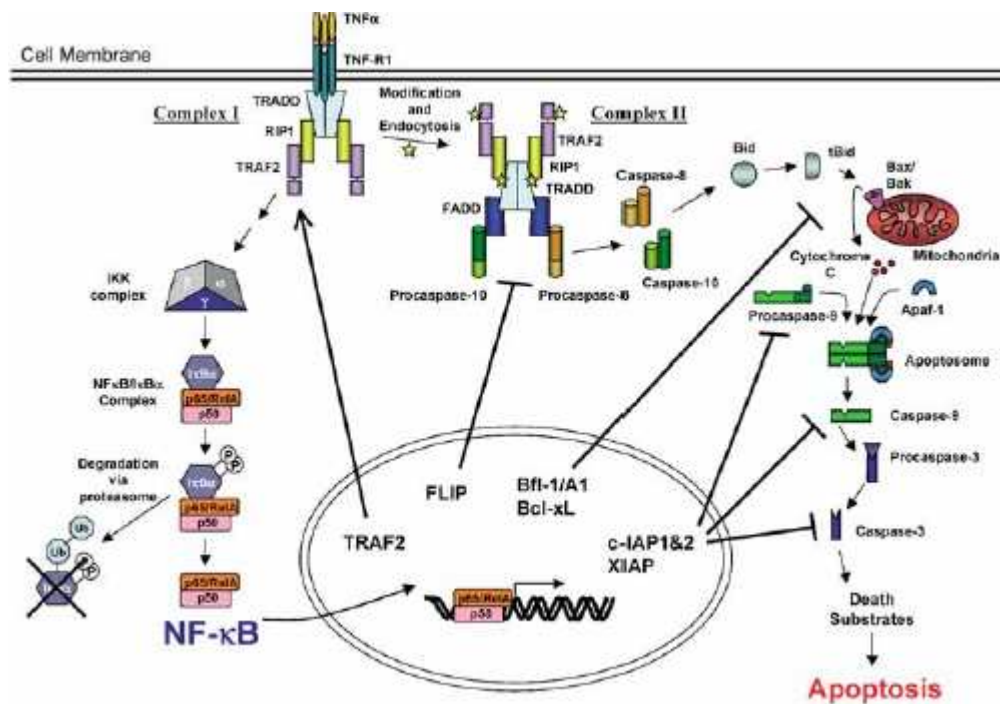

Figure 1.8 Survival and death pathways triggered by Complex I and Complex II of TNF signaling, respectively. (adopted from [136])

In TNF-R1 signaling, decision to die or to survive is made by cytosolic levels of cIAPs and FLIP, though effect of FLIP appears to be more pronounced than cIAPs. If NF- κ B activation triggered by Complex I is successful, cellular levels of FLIP will sufficiently increase to block caspase 8 activation in Complex II and cells will survive. If Complex I-triggered NF- κ B activation is not productive; FLIP levels will decrease, resulting in continuous caspase 8 activity and cells will die. [137]

While NF- κ B signaling negatively regulates apoptosis, ongoing apoptosis in turn interferes with the activation of NF- κ B. Several important components of this pathway such as RIP [138, 139], IKK β [140], Akt as well as NF- κ B subunits p50 and p65 themselves [141, 142] are cleaved by caspase 8 and caspase 3. Moreover, cleaved protein fragments released into cytosol act in a dominant-negative fashion towards their intact counterparts, further interrupting NF- κ B signaling. However, as a general *in vivo* characterization, it can be concluded that NF- κ B activation dominates over apoptosis induction in TNF-R1 signaling, whereas apoptosis induction is dominant over NF- κ B activation in Fas/CD95 signaling (Figure 1.7). In other words, TNF-R1 is an NF- κ B-inducing receptor, while Fas/CD95 is a death-inducing receptor [143].

It is noteworthy to mention here as a footnote that antiapoptotic effects of TNF-R1 signaling are not only limited to NF- κ B-driven transcriptional activation. TNF-induced Akt/PKB pathway provides alternative means to suppress apoptosis in an NF- κ B-independent way. (see “Akt/PKB signaling pathway” below)

1.1.4.3. TNF-Induced Activation of JNK

As mentioned above, TNF-R1 signaling is also coupled to JNK pathway via the adaptor protein TRAF2 [118, 119], which is an important component of “Complex I”. TRAF2 binds and activates the MAP3Ks, MEKK1 [121, 122] and/or ASK1 [120, 144], both of which in turn can phosphorylate and activate the MAP2K, MKK7 [145, 146] ; resulting in JNK activation. (see the other MAP2K, MKK4/SEK1 in “hsp70 and SAPK signaling” section). (Figure 1.9)

A second TRAF2-dependent JNK activation is based on the accumulation of ROS in response to TNF. Upon TNF stimulation, ROS is released from mitochondria to cytosol in a TRAF2-dependent way that is yet poorly understood [147]. To some extent, these species account for the cytotoxic effects of TNF signaling, against which thioredoxin (Trx) acts as a protective agent. Trx, which contains a redox-active center composed of two cysteine residues, is oxidized to Trx-S₂ in presence of ROS by a disulfide bridge formed between these two residues. However, under reducing conditions, Trx exists in its Trx-(SH)₂ form and functions as an inhibitor of ASK1 via direct interaction [148]. Therefore, TNF-induced generation of ROS leads to oxidation of Trx, release of ASK1 from inhibitory Trx-ASK1 complexes and subsequent formation of TRAF2-ASK1 complexes that are finally capable of activating JNK. Actually, TNF-induced ASK1 activation and interaction of TRAF2 with ASK1 require prior dissociation of thioredoxin from ASK1 [149, 150]. (Figure 1.9)

Cellular consequences of TNF-induced TRAF2-mediated JNK activation are poorly understood. There are contradictory reports on the role of JNK in TNF-induced apoptosis, implicating JNK with both pro-apoptotic [pro] [151] and anti-apoptotic [anti] abilities:

Mouse embryonic fibroblasts (MEFs) deficient in JNK (*JNK1*^{-/-}, *JNK2*^{-/-}) show increased sensitivity to TNF-induced apoptosis [anti] [152], whereas MEFs deficient in ASK1 are protected against TNF-induced cell death [pro] [153]. *TRAF2* knockout

MEFs, which have considerably active NF- κ B signaling yet impaired JNK activation, display increased sensitivity to TNF-induced apoptosis [anti]. However, in presence of JNK inhibitor, MEFs this time deficient in *p65* subunit of NF- κ B again display enhanced sensitivity to TNF-induced apoptosis [anti]. Finally, cells deficient in NF- κ B signaling demonstrate increased sensitivity to TNF-induced apoptosis under constitutive JNK activation [pro] [154]. It seems TNF activates JNK first transiently for regulation of cell survival [155], but then induces prolonged activation of JNK [pro] under apoptotic conditions in absence of NF- κ B activity [156]. However, re-establishment of NF- κ B activation limits the duration of JNK activation by inhibiting JNK pathway [157, 158] possibly via NF- κ B-dependent expression of genes *A20*, *Gadd45 β* [159, 160], *XIAP* (*X-chromosome-linked IAP*) [161]. [162-164] (Figure 1.9)

In a recent report by Deng et al. [165], siRNA-mediated knockdown of MKK7 has been shown to prevent TNF-induced caspase 8 processing and apoptosis in *p65*-deficient MEFs or HeLa cells that express a mutant form of I- κ B [pro]. According to the study, TNF induces a MKK7-(and JNK-)dependent cleavage of the pro-apoptotic Bcl-2 family protein Bid via a unique processing that differs from the previously identified [96] processing of Bid by caspase 8 (tBid). The novel cleaved product, jBid, translocates to the mitochondria, selectively inducing the release of Smac but *not* of cytochrome c. How jBid promotes caspase 8 processing via Smac remains to be resolved. (PS: It is *not* through antagonizing effect of Smac on cIAPs [134], because cIAPs have been shown to fail interacting with caspase 8. Remarkably, overexpression of cIAPs does not protect from TNF-induced apoptosis, whereas overexpression of FLIP does.[137] -see above-) (Figure 1.9)

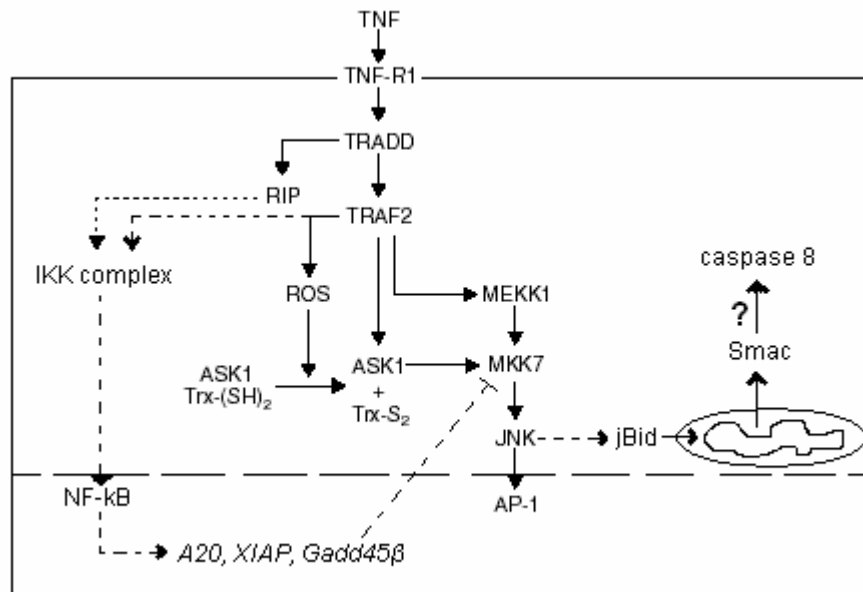

Figure 1.9 TNF-induced activation of JNK and regulation by NF- κ B-dependent gene expression. (modified from [143])

Although the first report, indicating the ability of hsp70 overexpression to prevent TNF-stimulated cell death, was published more than a decade ago [4], there have been very few reports on regulation of TNF-induced apoptosis by heat shock proteins, since then. One such study by Gabai et al. [166] has demonstrated that hsp70 suppresses TNF-induced apoptosis via inhibition of JNK, which in turn inhibits Bid cleavage and subsequent events of the mitochondrial apoptotic pathway, including release of cytochrome c, activation of caspase 3, and cleavage of PARP. In this report, Bid cleavage and activation are *not* found to be associated with caspase 8 activity. A chaperone-defective mutant of hsp70 (hsp70 Δ EEVD) is also effective in preventing both TNF-induced JNK activation and JNK-induced Bid cleavage. As being a negative regulator of ASK1 [89], it is tempting to speculate that hsp70 can also prevent TNF-induced JNK-mediated apoptosis via directly interacting and inhibiting ASK1. This possibility has yet to be studied.

Last, but not least; hsp70 has been reported in suppression of TNF-R1 death pathway downstream of caspase 3 activation. Cytosolic phospholipase A₂ (cPLA₂), an enzyme catalyzing the release of arachidonic acid from the sn-2 position of phospholipids, is one of the caspase-activated mediators of TNF-induced cell death [167]. Hsp70 inhibits activation of the cPLA₂, emphasizing its antiapoptotic effect in late-caspase dependent events, as well [168]. Given their diverse functions in preventing

apoptosis, the molecular basis of how heat shock proteins regulate TNF-induced apoptosis remains to be resolved by future studies. (see also “TNF-induced NF- κ B signaling pathway”)

1.1.5. Hsp70 and Ras/Raf-1 Signaling Pathway

The “classical” Ras—Raf-1—MEK1/2—ERK1/2 signaling is one of the most studied MAPK signaling pathways, which has mainly been implicated in cell growth, proliferation and differentiation. A wide variety of extracellular signals (growth factors, etc.) activate membrane-bound receptors such as receptor tyrosine kinases (RTKs), integrins or ion channels; transducing the signal to the small GTPase protein, Ras, via a set of adaptors (Shc, GRB2-growth factor receptor bound protein 2-, etc.) linking the receptors to guanine nucleotide exchange factors (Sos-son of sevenless-, etc). Activated GTP-bound Ras recruits the serine/threonine kinase Raf-1 to the membrane, where Raf-1 is activated by a group of activating proteins in a process that is poorly understood. Activated Raf-1, a MAP3K itself, phosphorylates and activates MAP2Ks, MEK1/2; which in turn phosphorylates and activates the MAPKs, ERK1/2 (extracellular signal-regulated kinase 1/2). [169, 170] (Figure 1.10)

In addition to SAPK/JNK pathway, the classical Ras/Raf-1 pathway has also been implicated to get activated by heat shock. Prevention of ERK1 activation during heat shock increases heat sensitivity, whereas overexpression of wild type ERK1 protects cells from stress [171]. Increased MEK1/2 activation as well as impaired ERK phosphatases, MKP1/3 (MAPK phosphatase 1/3), accounts for the increase in ERK1 activity during heat shock. Surprisingly, overexpression of hsp70 causes a decrease in ERK activity, which could otherwise help hsp70 protect cells from stress. This is due to an ability of hsp70 to prevent heat-induced inactivation of ERK phosphatases MKP1 and MKP3 [172]. (An identical regulation by hsp70 on JNK phosphatase has been mentioned before [85].) A chaperone-defective mutant of hsp70 (hsp70 Δ EEVD) is unable to protect these phosphatases from heat-induced aggregation. (Figure 1.10)

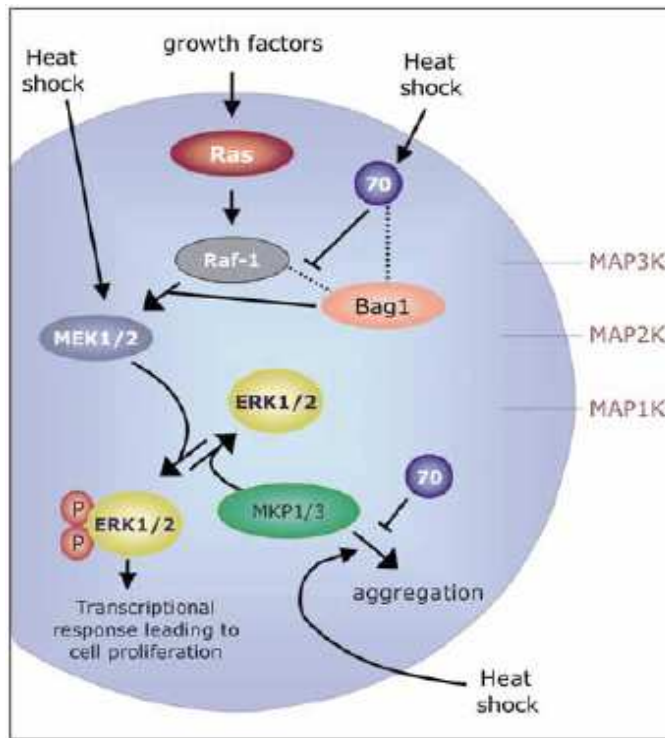

Figure 1.10 Regulation of Ras/Raf-1 signaling by hsp70-Bag1. Dotted lines indicate interactions that have been demonstrated *in vitro*. (adopted from [19])

As mentioned before at the end of “hsp70 co-chaperones” part; Bag1, the negative-regulator of hsp70 [28, 30, 31], is able to activate Raf-1 via direct interaction that occurs between the C-terminal domain of Bag1 and the catalytic kinase domain of Raf-1 [34]. The activation is essentially Ras-independent: Raf-1 activation by Bag1 circumvents the effects of overexpression of a dominant-negative form of Ras. Interestingly, Raf-1 interaction domain on Bag1 overlaps with that of hsp70, which creates a competition between these two proteins for binding to Bag1. Purified hsp70 added onto preformed Raf-1–Bag1 complexes sequesters all available Bag1, displacing Raf-1 from Bag1 and consequentially results in impaired Bag-1 activated Raf-1 kinase activity [173]. This implies another inhibitory effect of hsp70 on cell growth and proliferation and explains why in stably-transfected cell lines hsp70 exerts a negative effect on cell growth [174]. (Figure 1.10 and Figure 1.23)

Last, but not least; hsp70 has been found to interact with Mos, a germ cell-specific MAP3K that plays an essential role during meiotic divisions of oocytes. Mutations in the key serine 3 residue of Mos inhibits kinase activity and association with its target protein, MEK1. The same mutation also disrupts hsp70 binding to Mos,

suggesting a similar way of competition between hsp70 and MEK1 for interacting with Mos, as in the case of hsp70 and Raf-1 mentioned above. [175]

The above-mentioned three repressive effects of hsp70 on cell growth and proliferation suggest an evolutionary adaptation of cells to arrest cell cycle progression in response to heat stress, saving cells enough time to repair heat-induced damage and eliminate lethal effects of cytotoxicity prior to a new round of cell division. (For an excellent review on “cell cycle regulation by chaperones”, see [176])

General overview of chaperone network in eukaryotic cytosol:

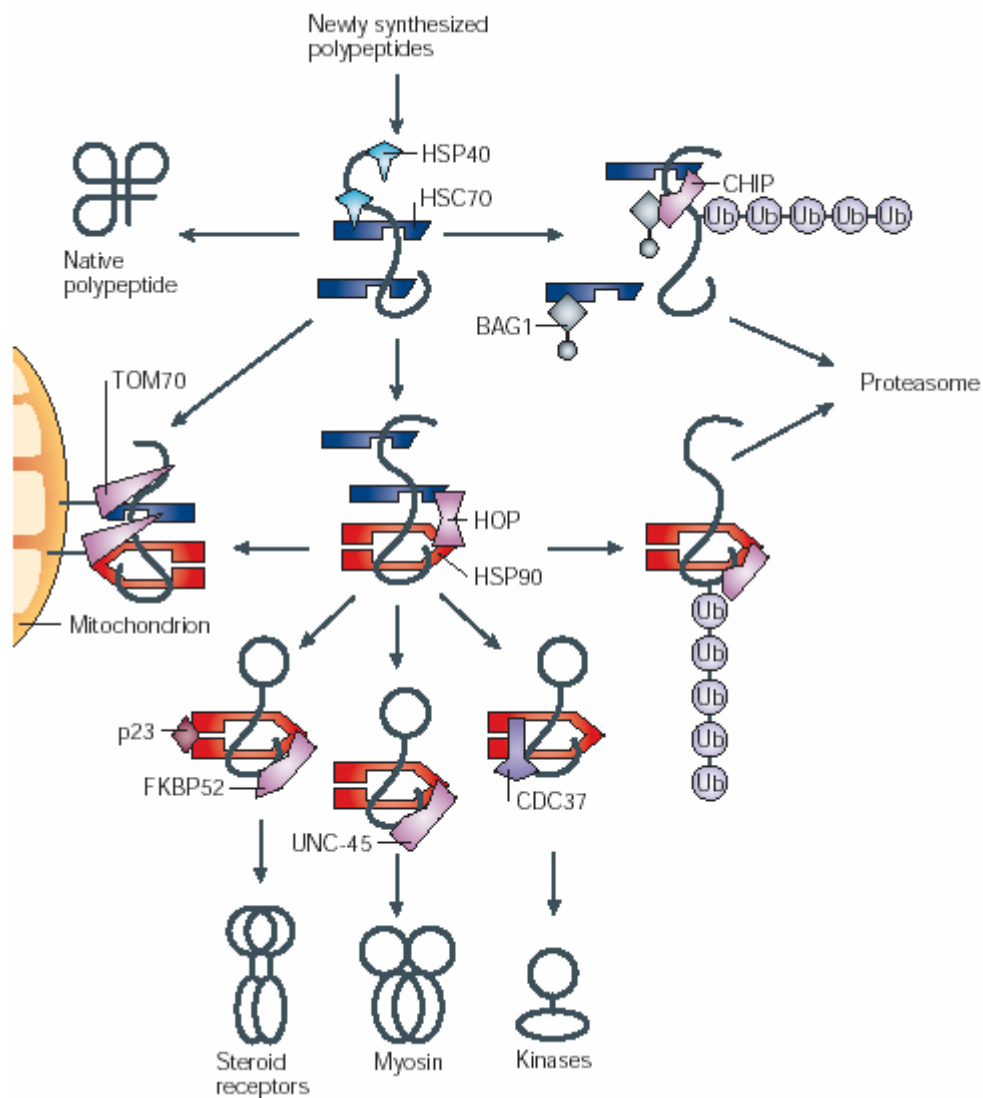

Figure 1.11 The late chaperone network of the eukaryotic cytosol. (adopted from [177])

1.2. Heat Shock Protein 90 (HSP90)

1.2.1. Structure and Function

Unlike hsp70, eukaryotic cytosolic hsp90 does not function in either folding of nascent unfolded polypeptide chains, or in refolding of heat-denatured proteins to their native states [6, 14]. Under protein-damaging stress conditions, hsp90 seems to be responsible only for maintenance of partially denatured proteins in a “folding-competent” state [178], transferring them to hsp70/hsp40 chaperone complex, which carries out the refolding process [179]. No role for hsp90 in refolding heat-damaged proteins *in vivo* has been demonstrated so far, although overexpression of hsp90 has been reported to produce some level of induced thermotolerance [180].

Under normal conditions, hsp90 functions in a unique manner that distinguishes it from other chaperones: Hsp90 binds to substrate proteins at intermediate folding states, holding and stabilizing them in functionally-competent conformations as well as preventing their degradation [179]. This role of hsp90 is vital for the proper activation of components of the signal transduction including steroid hormone receptors [181, 182] and a growing list of protein kinases [183], only some of which will be discussed later [184]. (see “Hsp90 and signal transduction”)

Like hsp70, hsp90-cycle of substrate binding and release is driven by ATPase activity of hsp90 [185-187]; but in a more complicated manner than that of hsp70, this cycle is operated by a multichaperone machinery that requires hsp70 itself [188] and several other co-chaperones (Figure 1.17). As mentioned above, hsp90 recognizes substrate proteins at intermediate stages of folding [178], placing hsp90 after hsp70-which binds to unfolded nascent polypeptides. Therefore, the two major chaperones, hsp70 and hsp90, cooperate in folding of certain client proteins in eukaryotic cytosol [188-190]. [177] (Figure 1.11)

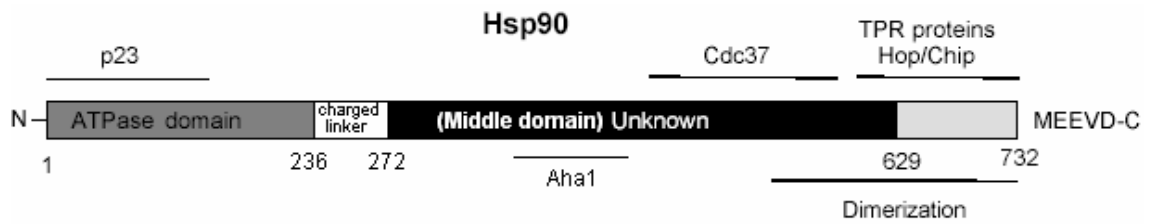

Figure 1.12 Schematic representation of the domain structure and co-chaperone binding sites of hsp90. (modified from [20])

Hsp90 is constitutively expressed in cells and is one of the most abundant proteins, constituting 1-2% of the total cellular protein content [191]. The highly conserved 25 kDa N-terminal domain consists of 8-stranded β -sheet structure with α -helices on each side. At the center, a deep cleft between these two secondary structures forms the binding site for ATP/ADP [192] (Figure 1.13) and for the hsp90-specific antitumor drug-geldanamycin (GA) [193, 194] (Figure 1.20). Hsp90 is a low-affinity ATP-binding protein [191]. GA replaces the nucleotide in the cleft with an affinity much greater than either ATP or ADP, inhibiting hsp90 ATPase activity even in nanomolar concentrations (in tumor cells-see below-). The TPR-unrelated hsp90 co-chaperone, p23, binds to the N-terminal domain of hsp90, as well (Figure 1.12).

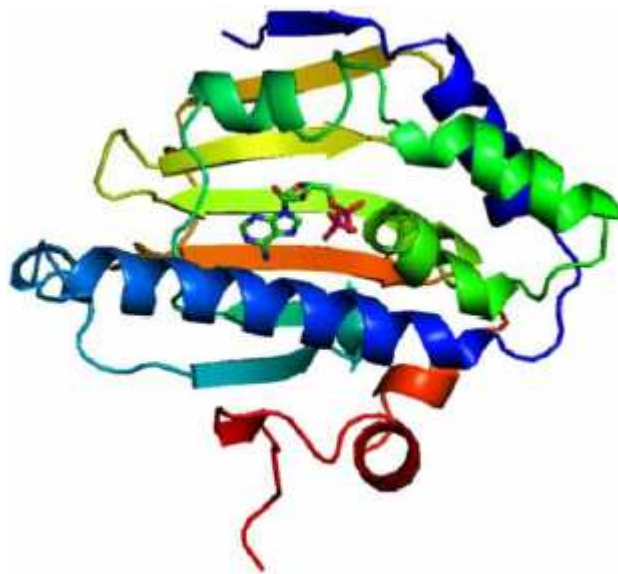

Figure 1.13 N-terminal domain of yeast hsp90 complexed with ADP. A secondary structure cartoon of the crystal structure of the N-terminal hsp90 domain (ending at residue 215), complexed with ADP [192]. (adopted from [195])

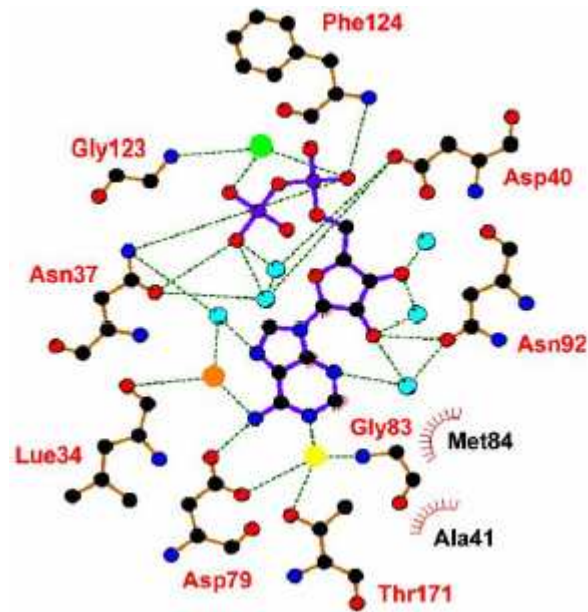

Figure 1.14 Diagram displaying the molecular interactions of the N-terminal domain of hsp90 with ADP. (yellow and orange spheres are water molecules, whereas green one is the magnesium ion, essential for the binding of ADP) (adopted from [195])

A highly charged linker/hinge region with an unknown function separates N-terminal domain from the middle domain. However, this region has been suggested to play a role in regulation of hsp90 association with its client proteins [196]. The structurally flexible 35 kDa middle region (Figure 1.15) has been found to interact with the hsp90 co-chaperones p50/cdc37 and the recently discovered Aha1 (Figure 1.12).

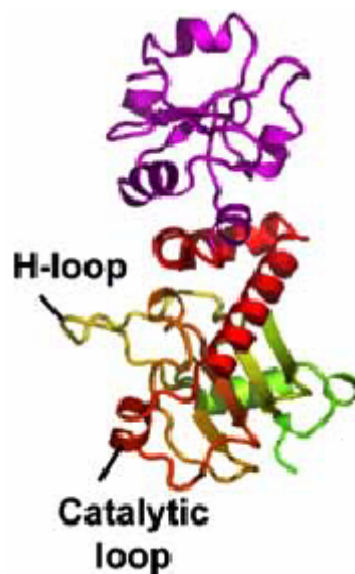

Figure 1.15 Cartoon structure of the hsp90 middle domain (residues 273-525). (adopted from [195])

The 12 kDa C-terminal domain is required for dimerization, since hsp90 is constitutively present as a homodimer in eukaryotic cytosol [197, 198]. As in hsp70, the TPR-domain containing co-chaperones, Hop and CHIP, recognize and bind to C-terminal domain of hsp90 [199] (Figure 1.12). And likewise, the C-terminal region of hsp90 ends with the highly-conserved sequence, MEEVD. Additionally, it has recently been discovered that this region harbors a second ATP-binding site, which is only exposed upon nucleotide binding to the N-terminal ATP-binding site [200]. However, the functional importance of this second site for substrate-binding and release cycle of hsp90 has not been demonstrated yet. Unlike hsp70, hsp90 does not seem to possess a consensus substrate recognition domain. Both N- and C-terminal domains of hsp90 have been implicated in binding of substrate proteins [201, 202]. [203]

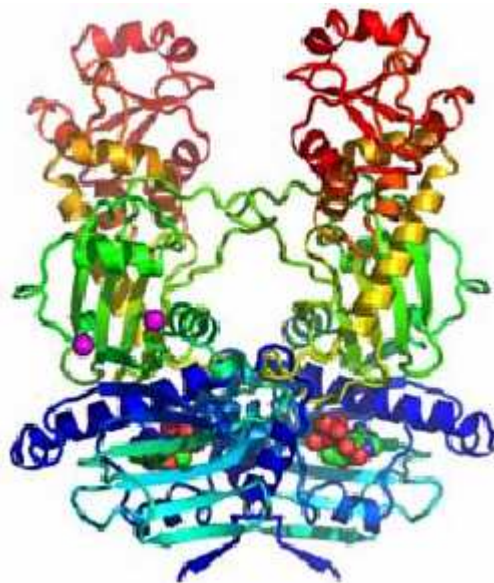

Figure 1.16 Model of N-terminally dimerized hsp90 (residues 2-525) constructed from its structural fragments. The 'inner' faces of the jaws in the Hsp90 molecular clamp are suggested to provide client protein-binding site(s). (adopted from [195])

1.2.2. Molecular Mechanism of Hsp90 Multichaperone Complex Function and Regulation by Co-Chaperones

As mentioned briefly above, hsp90 acts in succession to hsp70 in the multichaperone complex, also referred as the “super-chaperone machine” [204] (Figure 1.11). The machine cycles between two major conformations: ADP-bound (open) and ATP-bound (closed) [185-187] (Figure 1.17). An unfolded hsp90 client protein first associates with the hsp70/hsp40 chaperone complex and gets partially folded here [188-190].

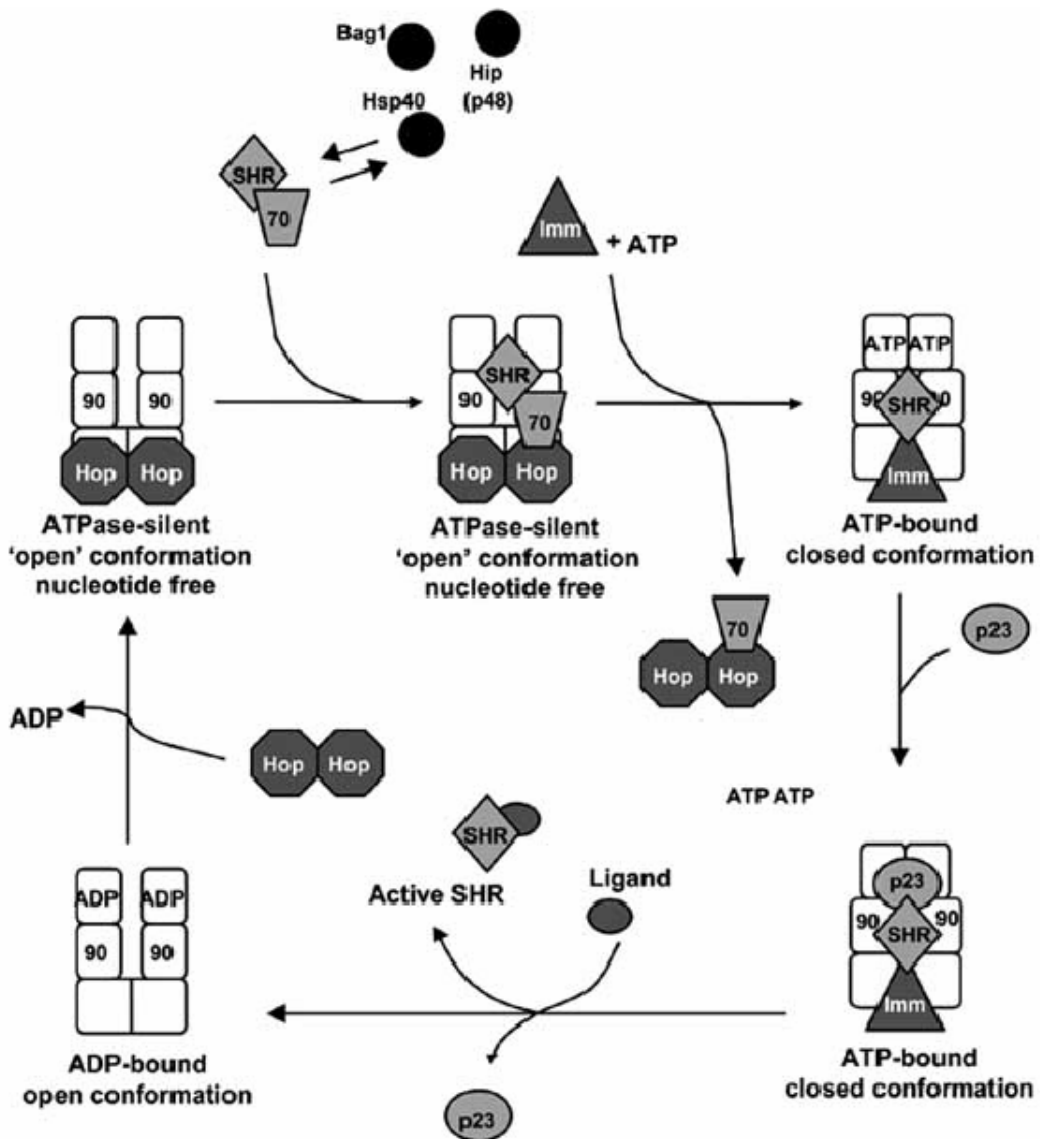

Figure 1.17 Activation of steroid hormone receptor (SHR) by hsp90. Aha1 is not shown as part of the 'closed' complex since its presence in SHR complexes has not been confirmed. (Imm., Immunophilins) (adopted from [195])

Then the bilateral co-chaperone Hop (**h**sp**s** **o**rganizing **p**rotein) links hsp70 to hsp90, transferring the client protein to hsp90 [23, 205]. The bridging of hsp70 to hsp90 by Hop occurs via the common C-terminal TPR protein-binding domains of the chaperones. Hop also acts as an inhibitor of hsp90 ATPase activity, preventing access to the N-terminal ATP-binding domain of hsp90 [206]. At this point, the multichaperone is in its ADP-bound (open) conformation. By inhibiting hsp90 ATPase activity, Hop ensures the complete transfer of the client protein to hsp90, which could otherwise adopt the closed conformation prematurely upon ATP binding without the substrate protein having been loaded. [207, 208] (Figure 1.17)

After the substrate transfer is complete, ATP obtains access to the N-terminal ATP-binding site of hsp90, by an as yet unknown mechanism. Exchange of ADP with ATP in hsp90 causes dissociation of Hop and hsp70 from hsp90, and induces a conformational change [209]. At this point, hsp90 adopts the ATP-bound (closed) conformation in which N-termini of the hsp90 subunits transiently dimerize to close the molecular clamp of the homodimer [210, 211] (Figure 1.18). This closed conformation stably binds the substrate protein and recruits another set of hsp90 co-chaperones, including p23 [212] and certain immunophilins [213] or p50/cdc37 [214] (Figure 1.17). This temporary state is responsible for stabilization of the activation-competent states of the substrate protein kinases in several signal transduction pathways, as will be discussed in the next section. The co-chaperone p50/cdc37 has a unique role in determining substrate specificity of hsp90 in favor of such kinases that depend on hsp90 for maturation to their activation-competent states [214-217] (Figure 1.11).

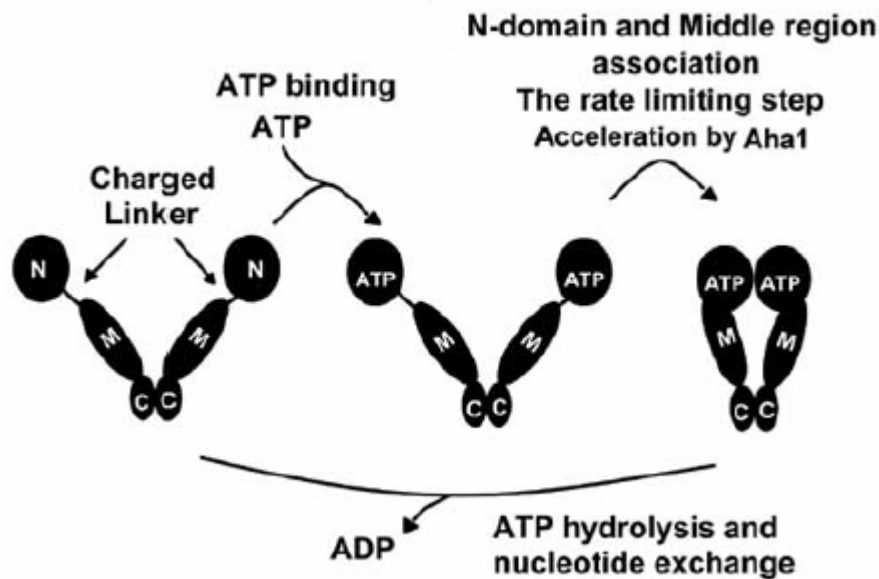

Figure 1.18 Rate limiting step of hsp90 multichaperone complex. Upon ATP binding, N-terminal domains of hsp90 subunits associate (closed conformation), which subsequently triggers ATP hydrolysis, suggesting N-terminal dimerization is the rate limiting step of ATP turnover. (adopted from [195])

The co-chaperone p23 [218] specifically recognizes the ATP-bound form of hsp90 and stabilizes this ATP-and substrate protein-bound transient state [219]. However, once ATP hydrolysis occurs, p23 stimulates ATP hydrolysis-dependent dissociation of substrate protein [220]. Dimerization of the ATP-binding domains produces the rate limiting step of ATP turnover in the multichaperone complex [210], accelerating inherent ATPase activity of hsp90 at this point (Figure 1.18 and Figure 1.19). A conformational change follows ATP hydrolysis, opening up the molecular clamp and releasing the substrate protein as well as the co-chaperones [185]. A new round of substrate binding starts upon recruitment of the other set of co-chaperones that prefer to associate with the ADP-bound (open) conformation of hsp90. (Figure 1.17)

Recently, a new hsp90 co-chaperone has been identified and named as Aha-1 (activator of hsp90 ATPase-1). Aha1 binding stimulates the inherent ATPase activity of hsp90 [221] (Figure 1.18 and Figure 1.19). There are apparently many more of them to be identified. The increasing number of co-chaperones inevitably implies a way of competition between them to bind to hsp90, suggesting the presence of another factor that specifies the priority of these interactions. Therefore, it has been proposed that co-chaperones might have a role in determining substrate specificity of hsp90 and in targeting hsp90 to specific substrate proteins [20]. (Figure 1.11)

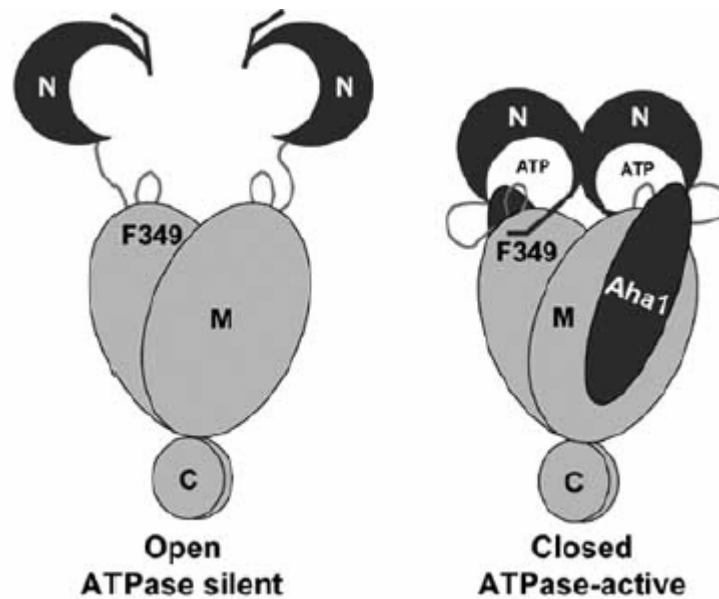

Figure 1.19 Rate limiting step of ATP turnover. Aha1 binds to the middle domain (M), promoting the ‘closed’ state and is required for full Hsp90 ATPase activity. (adopted from [195])

1.2.3. Hsp90 and Signal Transduction

A growing list of signal transduction proteins is being identified to depend on hsp90 for *in vivo* maturation and/or activation. These signaling proteins are typically large and found in multisubunits, requiring stabilization by other proteins for their proper function. It has been suggested that the need for structural flexibility to undergo different regulatory conformations in the course of signal transduction events might inherently necessitate a lesser stability for these proteins, thereby making them perfect substrates for hsp90.

Additionally, overexpression of hsp90 has been demonstrated in a wide variety of malignancies including breast, prostate, colon, lung, melanoma, leukemia, ovarian and cervical. As known, oncogenic transformation occurs via a process of acquired mutations in two sets of genes: proto-oncogenes and tumor suppressor genes. The corresponding mutant proteins exert their effects in cells, which result in either unrestrained cell proliferation or suppressed cell death (apoptosis). Overexpression of hsp90 in malignancies has been explained as an adaptive response of tumor cells (see “HSF-1” below) to sustain these two deregulated cellular events: accumulating

oncogenic mutations create an increasing demand for chaperone activity in tumor cells because mutated protein variants possess less than optimal folding characteristics. Thus, to maintain functionality in their less stable oncogenic forms, these proteins require stabilization in their active conformations by hsp90 chaperone. [222, 223]

Indeed, hsp90 client proteins are indicated in diverse cellular functions, most of which contribute to oncogenesis as well, including [183, 191, 224]:

1) protein kinases such as Akt/PKB, PDK1; MAP3Ks Raf-1, mutated B-Raf, Mos ; Bcr-Abl; src and related tyrosine kinases lck, fes, fgr, yes, fps; growth factor receptors (RTKs) EGFR, VEGFR, PDGFR, HER-2, IGFR, insulin receptor; FAK; casein kinase (CK-II); heme-regulated eIF-2 kinase, calmodulin regulated eEF-2 kinase; dsRNA-dependent kinase PKR; MAPKs MEK, MOK, MAK; tropomyosin-related kinase trkB; receptor-interacting protein (RIP) and IKK; and cell cycle progression kinases Cdk4, Cdk6, Wee1, Swe1, Polo mitotic kinase;

2) transcription factors such as mutated p53; heat shock factor-1 (HSF-1); steroid hormone receptors such as estrogen, androgen, progesterone, glucocorticoid receptors; and hypoxia-inducible factor-1 α (HIF-1 α);

3) others: Apaf-1; SV-40 large T antigen; proteasome; G protein subunits; endothelial nitric oxide synthase (eNOS); actin, tubulin; and telomerase (h-TERT).

1.2.3.1. Geldanamycin and Proteasome-Mediated Degradation of Hsp90 Client Proteins

The collection of hsp90 client proteins listed above would not have been possible without the discovery of hsp90-specific benzoquinone ansamycin drug, geldanamycin (GA) (Figure 1.22). Geldanamycin was initially discovered as naturally occurring antibiotics in the fermentation broth of *Streptomyces hygroscopicus* [225]. First report of GA effect in carcinogenesis was regression of v-Src induced transformation following inactivation of v-src by GA [226]. At that time, GA was thought to inhibit src and was regarded as a specific src inhibitor. However, affinity purification experiments conducted later with immobilized GA revealed that GA binds to and inhibits hsp90 [227], which subsequently leads to degradation of hsp90 client proteins in a proteasome-dependent manner.

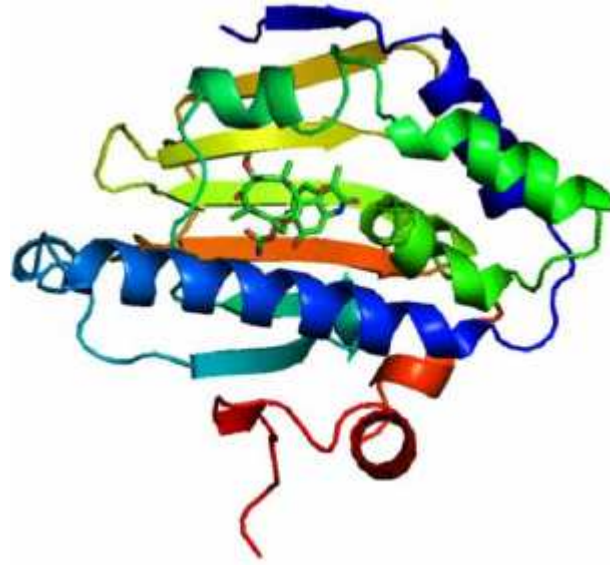

Figure 1.20 A secondary structure cartoon of the crystal structure of the N-terminal hsp90 domain (ending at residue 215), complexed with geldanamycin [193]. (adopted from [195])

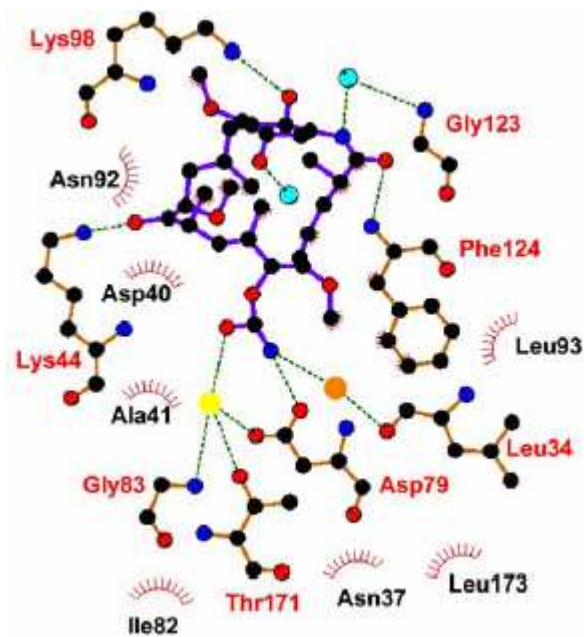

Figure 1.21 Diagram displaying the molecular interactions of the N-terminal domain of hsp90 with geldanamycin. (yellow and orange spheres are water molecules) (adopted from [195])

As also mentioned before, crystallography studies [193] demonstrated that geldanamycin binds tightly to the N-terminal ATP-binding pocket of hsp90 [194] (Figure 1.20). GA locks the multichaperone complex of hsp90-Hop-hsp70 in its substrate-bound (open) conformation, mimicking ADP-bound state of the complex (see above). Having a much higher affinity for hsp90 than either ATP or ADP [191], GA replaces ADP in this conformation, blocking exchange of ADP with ATP and the subsequent ATP hydrolysis-dependent dissociation of substrate proteins from the complex [228]. Therefore, GA binding causes a prolonged residence of yet premature/unstable substrate proteins on hsp90-Hop-hsp70 complex, which at this point seems to recruit specific ubiquitinating enzymes, targeting substrate proteins to the proteasome where they are degraded.

Hsp90 association with proteasome has been known for a long time [229], but only recently the missing link between these two has been discovered: The TPR-domain containing co-chaperone CHIP, which recognizes C-termini of both hsp70 and hsp90, has been shown to possess an E3 ubiquitin ligase activity [230] and to associate with the 19S subunit of the proteasome [231]. Consistently, overexpression of CHIP has been shown to promote ubiquitination and proteasome-mediated degradation of some hsp90 client proteins, including glucocorticoid receptor [231], HER-2 [232] and mutant p53 [233]. Similarly, another co-chaperone of hsp70, Bag1, has been also found to associate with 26S proteasome via its ubiquitin-like domain [234], providing additional link between the hsp70 chaperone system and the proteasome. (Figure 1.3)

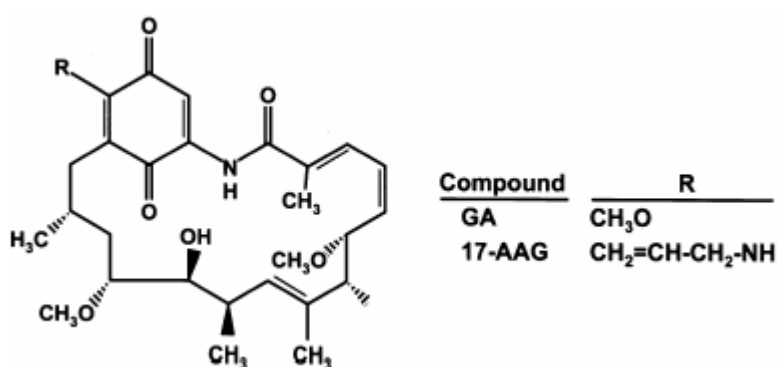

Figure 1.22 Chemical structures of GA and 17-AAG. (modified from [235])

Directing hsp90 client proteins, most of which are implicated in various oncogenic signal transduction pathways (see below), for degradation by only inhibiting

the ATPase activity of hsp90; geldanamycin has proved to be a potent anti-tumor drug *in vitro*. However, in clinical studies, GA has come out to be too toxic for cells. Soon, a less toxic but equally effective drug, 17-allylamino-geldanamycin (17-AAG) has been developed, which only differs from GA at the 17 position [236] (Figure 1.22). 17-AAG is currently in clinical trials, ready to enter Phase II trials after having completed Phase I trials successfully [237, 238].

Inhibition of hsp90 by 17-AAG has several unique advantages as a therapeutic target [239]:

1) Drugs targeting only a specific protein in a single oncogenic pathway can readily be circumvented by tumor cells, which are capable of activating an alternative pathway to sustain cell proliferation. As listed above, many oncogenic proteins rely on hsp90 for stabilization and functionality, making hsp90 inhibition a target for *multiple* pathways simultaneously.

2) Hsp90 is overexpressed in tumor cells progressively with the newly mutated oncoproteins as an adaptive response of tumor cells, yet poorly understood. (see “HSF-1” below) Therefore, inhibition of hsp90 proves to be a *dynamic* target for the ever-increasing accumulation of mutated oncoproteins in tumor cells.

3) Drugs targeting specific oncogenic proteins implement their effects only reversibly, with target proteins becoming fully active again immediately after withdrawal of inhibitory drugs. However, with hsp90-specific drugs, the real target proteins—the client oncoproteins of hsp90—are affected *indirectly* and *irreversibly*. The reversible inhibition of hsp90 by 17-AAG promotes an *irreversible* effect on the hsp90 client oncoproteins: proteasome-mediated degradation to amino acids. This saves an additional 12-24 hours for synthesis of new oncoproteins, during when tumor cells can be forced to undergo apoptosis by other supplementary drugs.

4) Even though hsp90 is abundantly expressed both in normal and tumor cells, 17-AAG *selectively* targets hsp90 in tumor cells, which displays a 20 to 200 times higher binding affinity for 17-AAG than does hsp90 in normal cells [240]. The increased affinity of 17-AAG for hsp90 in tumor cells is attributed to co-chaperone-induced conformational changes in the ATP-binding site of hsp90. As mentioned before, hsp90 operates in a multichaperone complex that is loaded with hsp70 and other co-chaperones in a cyclic manner driven by its ATPase activity (Figure 1.17). Due to their increased requirement for hsp90 action, tumor cells have all their hsp90 assembled in multichaperone complexes with high ATPase activities, whereas hsp90 in normal

cells is mostly in an inactive, uncomplexed form with low binding affinity for ATP [240]. (recall that hsp90 alone is a low-affinity ATP-binding protein.) This explains why 17-AAG, an ATP-binding site-binding inhibitor of hsp90, displays a therapeutic selectivity for tumor cells. Consistently, this also accounts for the reason why 17-AAG works at micromolar concentrations with purified recombinant hsp90, whereas it is efficacious in tumor cells even at nanomolar concentrations.

1.2.3.2. Signaling Pathways Associated with Hsp90

As explained in detail above, many oncogenic signaling proteins depend on hsp90 for conformational maturation to activation-competent states. Some of them are discussed as follows:

1.2.3.2.1. Ras/Raf-1 Signaling Pathway

Ras/Raf-1 signaling pathway is one of the first oncogenic pathways that has been found to associate with hsp90. (The pathway has been described in hsp70 section before [169, 170].) Hsp90 interacts with and stabilizes the well-known proto-oncogene Raf-1. Prolonged exposure of mammalian cells to GA suppresses Ras—Raf-1—MEK—ERK signaling pathway by disrupting hsp90-Raf-1 complexes and subsequently leading to degradation of Raf-1 [241-243]. By contrast, short exposure to GA leads to Raf-1 activation, indicating that transient release of hsp90 is essential for activation. Duration-dependent effect of GA on Raf-1 suggests that hsp90 is required for maturation and stabilization of Raf-1, holding it in an activation-competent, yet inactive state [20]. (Figure 1.23)

The proper activation of Raf-1 by either Ras or Bag1 requires dissociation of hsp90 for induction of the right conformation for Raf-1 to recruit Ras or Bag1. As mentioned before, sequestration of Bag1 by hsp70 exerts an inhibitory effect on Ras-independent Raf-1 activation. [34, 173]

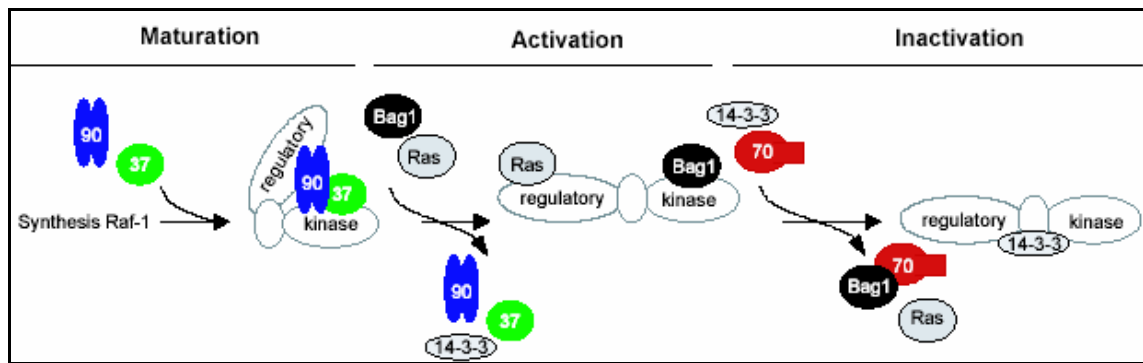

Figure 1.23 A model for chaperone and co-chaperone interactions of Raf-1, describing its maturation, activation and inactivation. (adopted from [20])

Hsp90 interaction with Raf-1 also requires the “kinase-specific” hsp90 co-chaperone p50/cdc37. Expression of a mutant cdc37 that can no longer bind to hsp90, has been shown to inhibit activation of Raf-1 by Ras, indicating that p50/cdc37 action in concert with hsp90 is essential for Raf-1 function [244].

Aside from its stabilizing effect on Raf-1, hsp90 has also been suggested to have a role in translocation/recruitment of Raf-1 from cytosol to Ras-bound plasma membrane sites. [20]

1.2.3.2.2. Akt/PKB Signaling Pathway

The other important cell proliferation and survival pathway associated with hsp90 is PI3K—PDK1—Akt/PKB signaling pathway: In response to a wide variety of extracellular stimuli (growth factors, etc.); membrane-bound receptors such as receptor tyrosine kinases (RTKs), integrins, cytokine receptors (IL-6 receptor family) and G-protein coupled receptors (GPCRs) activate phosphoinositide 3-kinase, PI3K, which in turn phosphorylates and converts the plasma membrane lipid phosphatidylinositol-4,5-biphosphate [PI(4,5)P₂] to phosphatidylinositol-3,4,5-triphosphate [PI(3,4,5)P₃]. PI(3,4,5)P₃ serves as a plasma membrane docking site for proteins that harbor PH (pleckstrin-homology) domains, including Akt/PKB (protein kinase B) and its upstream activator PDK1 (phosphoinositide-dependent kinase-1). Association with PI(3,4,5)P₃ at the membrane brings these two proteins into proximity, accelerating phosphorylation of Akt/PKB by PDK1. [245]

Phosphatases PTEN (**p**hosphatase-**a**nd-**t**ension homologue deleted on chromosome **ten**) and PP2A (**p**rotein **p**hosphatase **2A**), are known to act as negative regulators of PI3K—PDK1—Akt/PKB pathway. The tumor suppressor PTEN dephosphorylates PI(3,4,5)P₃ back to PI(4,5)P₂, reversing PI3K action; whereas PP2A dephosphorylates and inactivates Akt, reversing PDK1 action. [245]

Acting as a potent proto-oncogene, phosphorylated active Akt promotes cell proliferation, cell cycle progression and cell survival through *inhibitory* phosphorylation of many target proteins, some of which include FKHR-L1 (**f**ork**h**ead-**r**elated transcription factor), Bad, GSK-3 (**g**lycogen **s**ynthase **k**inase 3) and some CKIs (**c**yclin-**d**e**p**endent **k**inase **i**nhibitors). [245]

Phosphorylation of FKHR-L1 by Akt leads to its sequestration by cytosolic 14-3-3 proteins and blocks its translocation to the nucleus, thereby preventing transcriptional activation of its pro-apoptotic target genes, FasL and Bim. Likewise, phosphorylation of pro-apoptotic Bad by Akt promotes its sequestration by 14-3-3 proteins, which blocks Bad translocation to the mitochondria [246, 247]. Both of the above-mentioned effects can also be referred as antiapoptotic effects of Akt/PKB.

Phosphorylation by Akt also inhibits GSK3, which is a constitutively active kinase in unstimulated cells responsible for inactivation/proteasome-mediated degradation of proteins like glycogen synthase, eIF2B (**e**ukaryotic **i**nitiation **f**actor **2B**), cyclin D and c-Myc. Therefore, Akt is also implicated in protein synthesis as well as cell cycle progression through inactivation of GSK3 (see also below for GSK3 and Cyclin D). mTOR (**m**ammalian **t**arget **o**f **r**apamycin) and p70 S6K, which play role in cell growth and protein synthesis, are the other downstream components of this pathway, phosphorylated and activated by Akt and PDK1, respectively. [245]

1.2.3.2.2.1. Akt/PKB and TNF-Induced NF-κB Signaling Pathway

The components of Akt/PKB pathway are implicated in TNF-induced NF-κB (p50/p65) activation, as well. As explained briefly in “hsp70 and DR signaling” section, TNF-induced NF-κB pathway is essentially anti-apoptotic with its NF-κB-driven transcriptional activation of cIAPs [126, 127] and FLIP [128, 129] (Figure 1.8). Akt/PKB signaling has been found to ensure its anti-apoptotic, pro-survival effect by upregulation of NF-κB upon TNF induction via several distinct ways [248]:

Akt, in part, phosphorylates and targets IκB for degradation, releasing NF-κB for nuclear translocation [249]. Additionally; in response to TNF, Akt can directly phosphorylate and activate IKKα, thereby leading to NF-κB activation [250-252]. Furthermore, upon TNF stimulation, Akt increases transactivation potential of the NF-κB subunit p65 via an IKKα-dependent manner [253-255], which is a required step for full NF-κB activity. Indeed, impairment of TNF-induced NF-κB activation by inhibitors of the upstream kinase PI3K occurs in a cell type-specific manner [256]: In response to PI3K inhibitors; cell lines, in which the ratio of IKKα to IKKβ is high, show more susceptibility to impairment of NF-κB DNA binding; whereas those with higher levels of IKKβ remain unaffected. Even though the upstream linkers have yet to be determined, this pathway of NF-κB activation can be summarized as follows: TNF—TNFR1—(TRAF2?)—PI3K—(PDK1)—Akt/PKB—IKKα . [249] (Figure 1.24)

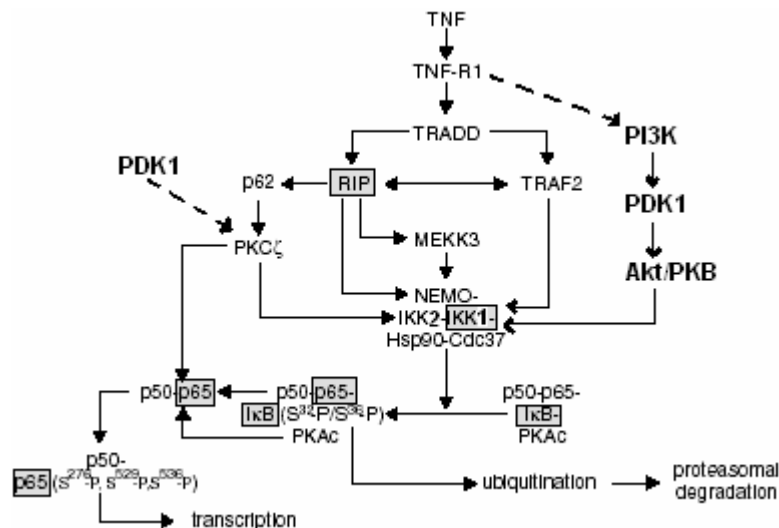
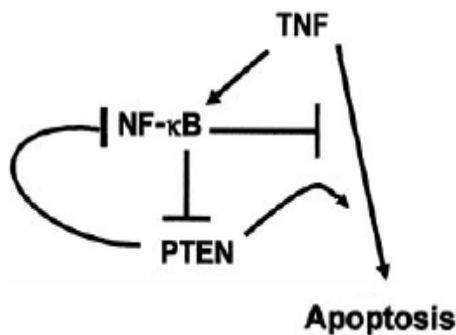

Figure 1.24 TNF-induced NF-κB activation and cross-talk with Akt/PKB pathway. (modified from [143])

In agreement with the above-mentioned role of Akt in TNF-induced NF-κB activation, PTEN, the natural biological inhibitor of Akt activity, blocks TNF-induced transcription of NF-κB-dependent genes [257] only by inhibiting the transactivation potential of the p65 subunit [258]. In other words, PTEN blocks the ability of TNF to stimulate the transactivation domain of p65. IκB degradation, p65 translocation to nucleus and NF-κB DNA binding are not affected by PTEN expression [258]. Thus, expression of the tumor suppressor PTEN inhibits the anti-apoptotic transcription factor NF-κB, sensitizing cells to TNF-induced apoptosis [258]. Interestingly, it has recently

been shown that NF- κ B does the same to PTEN: The p65 subunit down-regulates transcription of PTEN via sequestration of transcriptional coactivators CBP/p300 away from PTEN promoter [259]. Thus, NF- κ B-mediated suppression of PTEN adds one more to its anti-apoptotic abilities in the context of TNF-induced apoptosis. Below, the negative regulatory loop between PTEN and NF- κ B under TNF is shown (Figure 1.25)



This also describes a positive feedback loop, in which TNF-induced Akt activation of NF- κ B further stimulates Akt via repression of PTEN to ensure its continuous activation.

Figure 1.25 Negative regulatory loop between NF- κ B and PTEN involved in the modulation of TNF-induced apoptosis. (adopted from [259])

Akt phosphorylation of IKK α does not seem to be the only way for TNF-induced NF- κ B activation by PI3K—PDK1—Akt pathway. NF- κ B is alternatively activated by another component of this pathway, the atypical protein kinase C (PKC) isozyme, PKC ζ , which is normally another kinase substrate of PDK1 [260]. Upon TNF-stimulation, an adaptor protein called p62 links RIP to PKC ζ [261], which in turn phosphorylates and activates IKK β [262]. IKK β activation is followed by I κ B degradation and release of NF- κ B for nuclear translocation. For full NF- κ B activation, PKC ζ also phosphorylates and transactivates the p65 subunit [254, 263]. It is noteworthy to mention here that this signaling cascade of nuclear factor κ B (NF- κ B) activation, TNF—TNFR1—TRADD—RIP—p62—PKC ζ —IKK β , is essentially TRAF2-*independent*. (Figure 1.24)

Finally, the anti-apoptotic abilities of TNF-stimulated Akt/PKB pathway are not only limited to NF- κ B upregulation. In consistency with its anti-apoptotic properties in response to other stimuli mentioned in the first part, Akt can phosphorylate, and inactivate the pro-apoptotic protein Bad under TNF-stimulation, as well [264]. (Figure 1.6)

1.2.3.2.2. Hsp90 and Akt/PKB Pathway

Having finished describing diverse roles of Akt in promoting cell survival and proliferation, I will now discuss the contribution of hsp90 to this pathway. Being a potent proto-oncogene, Akt depends on hsp90 for its stability and activity [265, 266]. Hsp90, with its “kinase-specific” co-chaperone p50/cdc37 [214], holds Akt in an active conformation that facilitates its phosphorylation by PDK1. Moreover, hsp90 association protects Akt from PP2A-mediated dephosphorylation and inactivation. Consistently, inhibition of hsp90 by GA causes a rapid decrease in both Akt activity and protein level. (Figure 1.6)

In breast and prostate cancer cell lines that overexpress the receptor tyrosine kinase HER-2, 17-AAG inhibits phosphorylation of Akt prior to the loss of Akt protein levels [267]. This might be due to hsp90-dependent effects on the upstream activators HER-2 and PDK1 [268]. In fact, HER-2 *is* an hsp90 client protein [269] and is one of the most sensitive ones to 17-AAG or GA [270] (see the list of hsp90 client proteins). 17-AAG has been reported to cause cell cycle (G1) arrest that is associated with loss of cyclin D protein levels in HER-2 overexpressing breast cancer cells [267], in consistency with the following cascade [245]. (Figure 1.26)

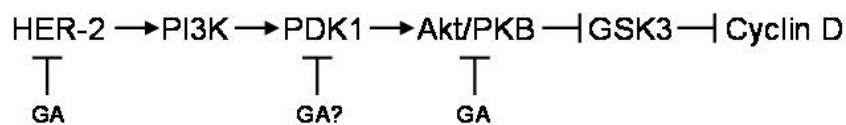

Figure 1.26 Inhibitory effects of geldanamycin (GA) at different stages through Akt/PKB signaling.

Disruption of Akt activity by GA abolishes all anti-apoptotic, pro-survival effects of this pathway and sensitizes cells to the pro-apoptotic effects of the anti-tumor agent taxol [271]. GA-induced degradation of Akt can also promote apoptosis via Bax-dependent release of cytochrome c and Smac/Diablo from mitochondria [272]. It has recently been reported that Akt–hsp90 complex can phosphorylate and inhibit the pro-apoptotic kinase ASK1, providing protection from stress-induced apoptosis [273, 274].

1.2.3.2.3. Apoptosis and Apaf-1

Another anti-apoptotic ability of hsp90 is implicated in inhibition of apoptosome formation, in the same manner as hsp70. Apaf-1 is one of the client proteins of hsp90 (see the list of hsp90 client proteins). Hsp90 binds to Apaf-1 and blocks cytochrome c/ATP-mediated oligomerization of Apaf-1 [275]. (Figure 1.6)

1.2.3.2.4. Heat Shock Factor-1 (HSF-1)

Another client protein of hsp90 is worthwhile mentioning here: heat shock factor-1 (HSF-1). HSF-1 is the major transcription factor that is responsible for the transcriptional activation of heat shock genes for the regulation of the heat shock response (HSR). In unstressed cells, HSF-1 exists in a monomeric non-DNA binding form. However, in response to protein-damaging stress conditions, HSF-1 forms homotrimers that acquire sequence-specific DNA binding ability for HSEs (heat shock elements) located in promoter regions of HSF-1-inducible genes. However, DNA binding of HSF-1 is not sufficient for transcriptional induction of these genes. Full HSF-1 transcriptional activity requires regulation of HSF-1 by several kinases: phosphorylation by GSK3 and JNK inhibits HSF-1 activity, whereas phosphorylation by CaMK-II (Ca⁺²/calmodulin-dependent kinase II) increases this activity [276, 277]. (Recall that hsp70 inhibits SAPK/JNK activation by several means under stress conditions, which have been described before [85, 86] (Figure 1.5), suggesting a positive feedback mechanism employed by hsps to ensure their continuous transcriptional expression by HSF-1 under such conditions.)

Monomeric inactive form of HSF-1 is a client protein for hsp90 under non-stress conditions [278]. Sequestration of the monomeric HSF-1 by hsp90 prevents inappropriate activation of the heat shock response under normal conditions. However, under stress conditions, cytosolic levels of misfolded proteins increase and accumulating misfolded proteins start to compete with HSF-1 for binding to hsp90. After a sufficient amount of HSF-1 is displaced from hsp90 by misfolded proteins, trimerization and transactivation of HSF-1 occurs, readily initiating the heat shock response. [279]

Even though the molecular basis of hsp upregulation in response to heat shock can be explained as above through HSF-1 transcriptional activity, the molecular mechanisms responsible for hsp overexpression in tumor cells are still poorly understood. It is not known whether HSF-1 is present in an active trimeric form in tumor cells. There are very few reports on the role of HSF-1 transcriptional activity in hsp upregulation in the context of tumorigenesis. One such study [280] on prostate adenocarcinoma cells indicates elevated basal levels of hsp27 to be in significant correlation with elevated HSF-1 protein levels. However, constitutive levels of hsp70 and hsp90 are not found to be significantly altered by elevated HSF-1 levels. The case is similar for retinoblastoma cells [281].

As mentioned before (see “hsp90 and signal transduction” above), hsp overexpression is thought to be an adaptive response of tumor cells to keep their increasing amount of oncogenic proteins in either active or activation-competent conformations. It has been suggested that elevated hsp expression levels can either be achieved by an increase in basal heat shock promoter activity via introduction of new mutations in transcription machinery or by a direct increase in activated HSF-1 protein levels [19]. The exact molecular details of hsp overexpression in a wide variety of tumor cells has yet to be resolved, but it seems likely that this may be tumor-specific: in a different carcinoma cell line, hsp90 overexpression has been found to be associated with gene amplification and *not* related with HSF-1 levels or activity [282].

1.2.3.2.5. TNF-Induced NF- κ B Signaling Pathway

Several different aspects of TNF signaling have been described in the text before (see “hsp70 and Death Receptor Signaling” for TNF-induced apoptosis and TNF-induced JNK activation. see “Akt/PKB signaling pathway” for an alternative way of TNF-induced NF- κ B activation.). In this section, the remaining aspect of TNF signaling, the canonical TNF-induced NF- κ B activation will be discussed.

TNF is primarily produced as a type II transmembrane protein, assembled in a stable homotrimer [109]. This membrane-integrated form is processed via a proteolytic cleavage by the metalloprotease TNF alpha converting enzyme (TACE) to produce the soluble homotrimeric cytokine [283], sTNF, which predominantly binds to constitutively expressed TNF-R1 [110] complexes of a neighboring cell. Upon ligand-

stimulation, preassembled (via their intracellular death domains [112]) aggregates of TNF-R1 rapidly reorganize in trimers, initiating TNF signaling (see “hsp70 and DR signaling”). [284]

TNF is mainly produced by macrophages. A broad variety of other cells, including lymphoid cells, mast cells, endothelial cells, fibroblasts and neuronal cells can produce TNF, as well. TNF can be considered as a major pro-inflammatory cytokine, with an optional capacity to induce apoptosis. In response to lipopolysaccharide (LPS) and other bacterial pathogens, sTNF is massively produced and released; launching the innate immune response by triggering local expression of chemokines, cytokines and promoting adhesion and activation of leukocytes at the sites of infection. At a later phase, TNF also facilitates transition from innate to acquired immunity by enhancing antigen presentation and T cell co-stimulation. [285-288]

Aside from its role in the inflammatory response, TNF signaling displays a unique functional duality, being strongly engaged both in tissue regeneration/expansion and destruction. Impaired or sustained activation of TNF signaling has been implicated in the pathogenesis of a wide range of human diseases, including sepsis, diabetes, cancer, transplant rejection and autoimmune diseases such as multiple sclerosis, rheumatoid arthritis and inflammatory bovine disease (Crohn’s disease) [143, 287, 289]. (Figure 1.27)

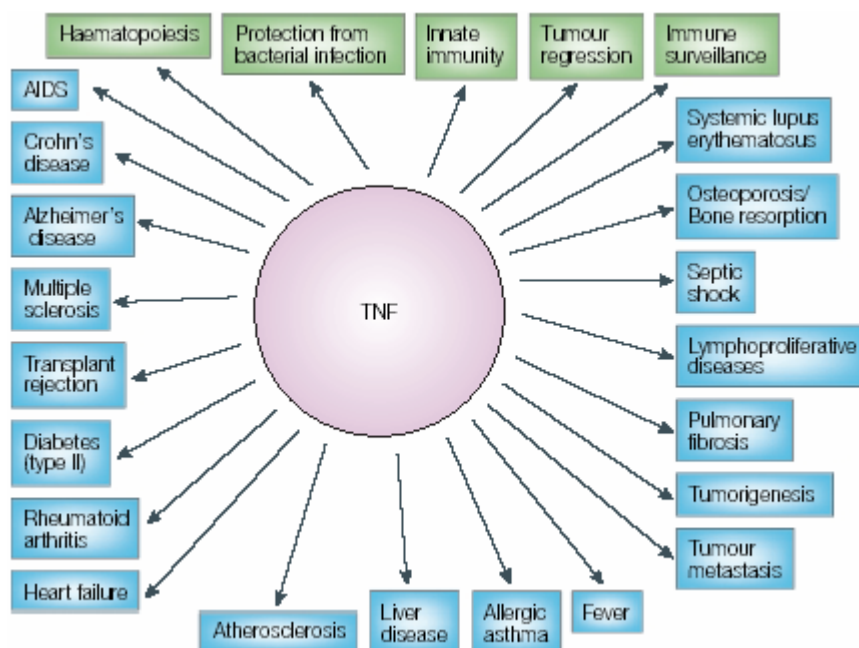

Figure 1.27 The main physiological (indicated in green) and pathological (indicated in blue) effects linked to members of the TNF superfamily. (adopted from [290])

TNF signaling cascade from TNF-R1 complex to TRAF2 and RIP recruitment (the formation of “Complex I”) has been described before [114, 115] (Figure 1.8). Although the mechanism for the recruitment of the IKK complex to Complex I is not completely understood, TRAF2 is known to be sufficient for this process [117], while RIP is necessary for the activation of the IKK complex [291] (see “Discussion” for the recent findings on this issue). Since RIP itself is dispensable for IKK activation, it has been suggested that there might be other kinases responsible for the activation of IKK in a RIP-dependent manner. A RIP interacting MAP3K, MEKK3, may provide the missing link between RIP and the IKK complex; but it is very likely that some other kinases are also taking part in this process (Figure 1.24). *MEKK3*-deficient MEFs show strongly reduced NF- κ B activation in response to TNF [292]. Furthermore, MEKK1 has been found to be interacting with TRAF2 and RIP after TNF stimulation in human HEK293 cells. MEKK1 also gets activated by TNF in a RIP-dependent manner in human T cell line Jurkat [293].

The IKK complex consists of two catalytic subunits, IKK α and IKK β (IKK1 and IKK2 [294-297]) and a regulatory subunit, NF- κ B essential modulator (NEMO or IKK γ [298]). The canonical IKK pathway is normally triggered in response to microbial or viral infection and exposure to pro-inflammatory cytokines (TNF, IL-1). Once activated, IKK complex phosphorylates NF- κ B-bound I κ Bs at two conserved serine residues in the I κ B N-terminal regulatory domain [299] (Figure 1.28). This marks I κ B for recognition by E3 ubiquitin ligase, targeting I κ B for proteasome-dependent degradation and liberating NF- κ B dimers for translocation to the nucleus [300]. I κ B phosphorylation depends mainly on IKK β subunit of the IKK complex [253, 301]. (Figure 1.24 and Figure 1.29)

In mammalian cells, there are five members of NF- κ B (**nuclear factor- κ B**)/Rel (**reticuloendotheliosis**) family, belonging to two groups: those that are synthesized in their mature forms and those that require proteolytic processing to become mature. The first group consists of RelA/p65, c-Rel and RelB. The second group includes NF- κ B1/p105, which is constitutively processed to produce the mature p50; and NF- κ B2/p100, which is inducibly processed to produce the mature p52. These two groups

dimerize–p50/p65 heterodimer is the main one [302]. All NF- κ B family members share the conserved **Rel homology domain (RHD)**, which mediates their dimerization, DNA binding, nuclear localization and interaction with the inhibitory I κ B proteins. C-terminus of RHD contains nuclear localization signal (NLS), which is masked upon I κ B binding. All I κ Bs contain 6-7 ankyrin repeats that mediate this binding. The isoforms I κ B α , I κ B β and I κ B ϵ possess two conserved serine residues at N-terminal regulatory domain, which are the sites of phosphorylation by the IKK complex. Lysine residues, which are targets for polyubiquitination, are also present in the N-terminal regulatory domain of these I κ Bs. Therefore, in unstimulated cells, NF- κ B dimers are retained in cytosol as a complex with I κ B proteins; whereas upon TNF- or IL-1-(and a variety of other inducers) stimulation, I κ Bs are targeted for proteasome-mediated degradation, releasing NF- κ B dimers for nuclear translocation. [303, 304] (Figure 1.28)

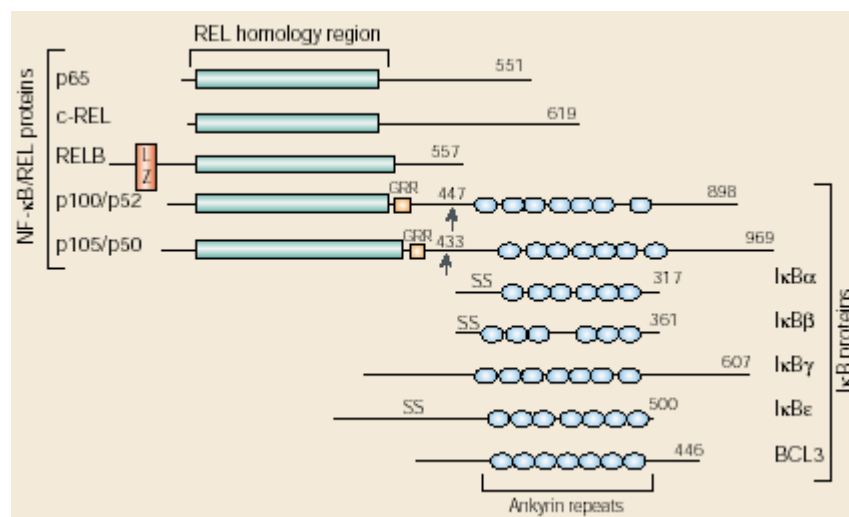

Figure 1.28 Schematic representation of the domain structures of NF- κ B/Rel family and I κ B proteins. (LZ, leucine-zipper region; GRR, glycine-rich region; SS, two conserved serine residues; arrows point proteolytic processing) (adopted from [304])

Like I κ Bs, p100 and p105 have ankyrin repeats within their C-terminal domains, which prevent their nuclear translocation. Ubiquitin-dependent proteolytic processing removes this region, resulting in products, p52 and p50 respectively, that contain RHD but lack transcription-modulating domains (Figure 1.28). For full NF- κ B activation, transcription-modulating region at the very C-terminal domain is indispensable. This accounts for the reason why p65 subunit of NF- κ B (p50/p65) is the transactivation subunit for this heterodimer. As mentioned several times in the text before [253-255,

263], nuclear translocation of p50/p65 heterodimer is not sufficient for its full transcriptional activity. Transactivation of p65 by phosphorylation at serines 529 and 536 is required. This can be accomplished by constitutively active protein kinases like casein kinase II (CKII) [305] and by several other kinases mentioned in Figure 1.29. [306, 307]. [288, 304] (see also Figure 1.24)

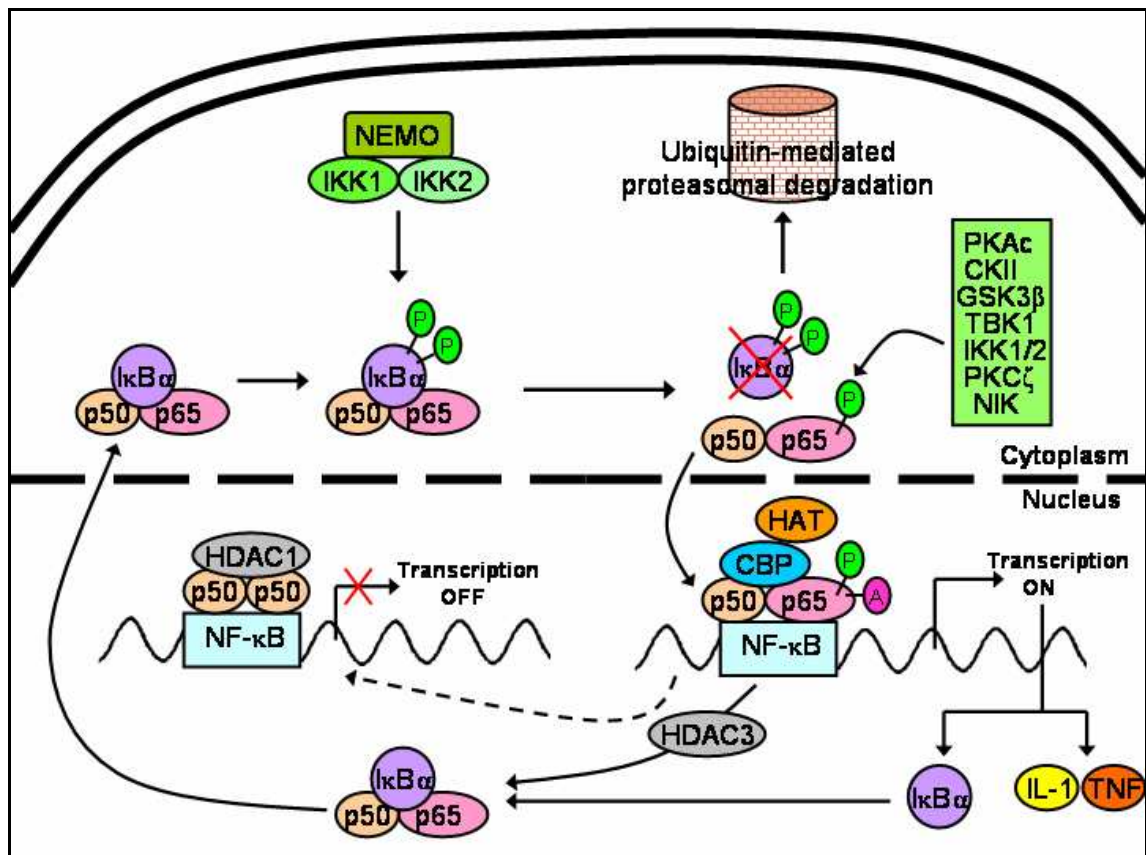

Figure 1.29 Regulation of transcriptional activity of NF- κ B and negative feedback mechanism operated by I κ B α . p50-p50-HDAC1 complexes have histone-deacetylase activity and therefore repress transcription, whereas p50-p65-CBP/HAT complexes have histone-acetylase activity and activate transcription. Furthermore, HDAC3 might help to switch off NF- κ B activity by deacetylating p65 and enhancing the binding affinity between p65-p50 and I κ B α . (CBP, CREB-binding protein; HDAC, histone deacetylase; HAT, histone acetyltransferase; P, phosphate group; A, acetyl group) (modified from [288])

NF- κ B contributes to the induction of five classes of genes: **1.** Negative feedback: I κ B α [308], I κ B β and A20 [309] have been identified as NF- κ B-inducible genes that are required for repression of continual TNF-induced NF- κ B activation after the initial stimulation (Figure 1.29). Of these, A20 appears to be TNF-selective, capable of interacting with TRAF2 [310] as well as NEMO [311]. **2.** Immunity [288], **3.** Anti-

apoptosis [126-129, 158, 159, 312-314], **4.** Proliferation [315, 316], **5.** Metastasis-Angiogenesis [317, 318] (Figure 1.30)

Aside from its most studied function, regulation of the inflammatory response and immunity, NF- κ B also contributes to tumorigenesis via promotion of cell proliferation, inhibition of apoptosis and induction of metastasis and angiogenesis. (refer to Figure 1.30)

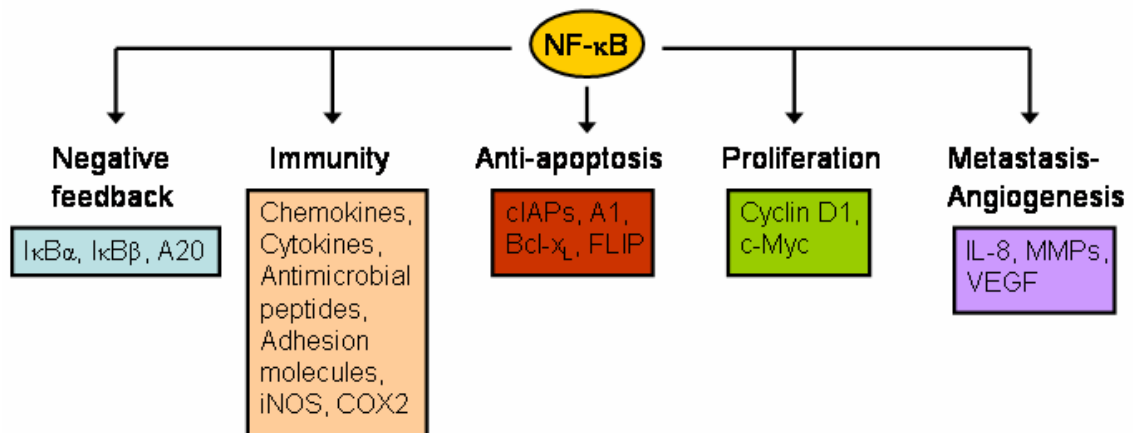

Figure 1.30 Five classes of NF- κ B-driven target genes. (modified from [304])

Hsp90 is implicated in TNF-induced NF- κ B activation at two steps: RIP [319] and the IKK complex [320]. Refer to “Discussion” for detailed description of the role of hsp90 in this pathway.

2. PURPOSE

Given their diverse functions in protein folding/refolding, protein translocation/shuttling, protein activity via stabilization and/or maturation to functionally-competent conformation and protein turnover; heat shock proteins play key roles in thermoregulation, signal transduction, cell cycle control, development and transcriptional regulation.

TNF signaling is a very unique signal transduction pathway that has mainly been implicated in inflammatory response and immunity, yet with optional functions in both cell survival and cell death (apoptosis). This study aims to investigate the role of heat shock proteins in TNF-induced NF- κ B pathway for short-term purposes. For long-term purposes, the study aims to search for any possible cross-talk between divergent downstream pathways of TNF signaling that might occur via heat shock proteins.

3. MATERIALS

3.1. Chemicals and Media

Acrylamide / Bisacrylamide (30%)	Sigma, Germany
Acrylamide / Bisacrylamide (40%)	Bio-Rad, USA
Agarose low EEO	AppliChem, Germany
Ampicillin-Na salt	Serva, Germany
APS (for electrophoresis)	Sigma, Germany
Boric acid	Riedel-de Haen, Germany
Bromophenol Blue (electrophoresis grade)	AppliChem, Germany
BSA (blot-qualified)	Promega, USA
Coomassie Brilliant Blue	Merck, Germany
Developer solution	Agfa, USA
DMSO (tissue-culture grade)	Sigma, Germany
DTT	Fluka, Germany
EDTA	Sigma, Germany
Ethanol	Merck, Germany
Ethidium bromide	Merck, Germany
FCS / FBS	Biological Industries, Israel
Fixer solution	Agfa, USA
Glycerol	Riedel-de Haen, Germany
Glycine	Amresco, USA
HCl	Merck, Germany
HEPES	Fluka, Germany
Isopropanol (2-propanol)	Riedel-de Haen, Germany
Kanamycin-sulfate	AppliChem, Germany

KCl	Fluka, Germany
KOH	Riedel-de Haen, Germany
LB Agar	Sigma, Germany
LB Broth	Sigma, Germany
L-glutamine	Merck, Germany
Liquid Nitrogen	Karbogaz, Turkey
MEM	Sigma, Germany
2-Mercaptoethanol	Fluka, Germany
Methanol	Merck, Germany
MgCl ₂ .6H ₂ O	Riedel-de Haen, Germany
NaCl	Riedel-de Haen, Germany
NaHCO ₃	Riedel-de Haen, Germany
NaOH	Merck, Germany
Non-fat dry milk	Pinar, Turkey
NP-40 (IGEPAL CA-630)	Sigma, USA
NP-40 (IGEPAL CA-630)	Calbiochem, Germany
PBS (10X)	Sigma, Germany
PBS (1X)	Biological Industries, Israel
Penicillin / Streptomycin	Sigma, Germany
PMSF	Sigma, Germany
RPMI-1640	Biological Industries, Israel
SDS	Amresco, USA
TEMED	Sigma, Germany
Tris base	Amresco, USA
Trypsin / EDTA (1X)	Biological Industries, Israel
Tween-20 TM	Merck, Germany

3.2. Kits

ECL Advance™ Western Blotting Detection Kit	Amersham Biosciences, UK
PureYield™ Plasmid MidiPrep Kit	Promega, USA
QIAGEN® Plasmid Midi Kit (100)	Qiagen, Germany
SuperSignal® West Dura extended duration substrate detection kit	Pierce, USA

3.3. Antibodies

Anti-FLAG M2 antibody, mouse monoclonal	Sigma, Germany
Anti-hsp70 antibody, mouse monoclonal	Abcam, UK
Anti-hsp90 antibody, mouse monoclonal	Abcam, UK
Anti-mouse antibody HRP-linked, (from sheep)	Amersham Biosciences, UK
Anti-p50 subunit antibody, goat polyclonal	Santa Cruz Biotechnology, USA
Anti-β-actin antibody, mouse monoclonal	Abcam, UK

3.4. Enzymes

Restriction endonucleases (<i>Spe</i> I, <i>Nae</i> I, <i>Xba</i> I, <i>Hind</i> III, <i>Pst</i> I, <i>Xho</i> I, <i>Sph</i> I)	Promega, USA
T4 polynucleotide kinase	Promega, USA

3.5. Cells

HeLa, human cervix carcinoma cell line	HUKUK, Turkey
TOP10 E.coli strain, one-shot ready competent	Invitrogen, Germany

3.6. Vectors

pMAX-GFP	Amara Biosystems, USA
pRK7-FLAG-IKK α	provided kindly by Nesrin Ozoren from University of Michigan, USA

3.7. Others

Adenosine 5-[γ - ³² P]-triphosphate	Izotop, Hungary
Biomax 18X24, Intensifying Screen 24X30 Cassettes	Kodak, USA
Biomax MS Film	Kodak, USA
Bradford reagent	Bio-Rad, USA
Complete TM protease inhibitor cocktail tablet	Roche, Germany
DNA loading dye (6X)	Fermentas, Germany
Electroporation cuvettes, 4 mm	BTX, USA
Flat gel-loading tips	Rainin, USA
Fugene 6 TM transfection reagent	Roche, Germany
G-25 Sephadex Quick Spin Column	Roche, Germany
Geldanamycin (GA)	Sigma, Germany
GeneRuler TM 1 kb DNA ladder	Fermentas, Germany
GeneRuler TM 100 bp DNA ladder	Fermentas, Germany
Hybond-P membrane (PVDF)	Amersham Biosciences, UK
Hyperfilm ECL	Amersham Biosciences, UK

Interleukin-1 β (human, recombinant)	Biosource, USA
Interleukin-1 β (rat, recombinant)	Sigma, Germany
Laemmli 2X Sample Buffer	Sigma, Germany
Milk diluent blocking solution	K&P Laboratories, USA
NF- κ B consensus oligonucleotide	Promega, USA
Plastic wrap	Dia, Turkey
poly dI-dC—poly dI-dC	Sigma, Germany
Prestained protein molecular weight marker	Fermentas, Germany
Protein G Sepharose TM 4 Fast Flow	Amersham Biosciences, UK
T4 Kinase Buffer (10X)	Promega, USA
Tumor necrosis factor- α (human, recombinant)	Sigma, Germany
Tumor necrosis factor- α (human, recombinant)	Biosource, USA

3.8. Equipment

Autoclave:	Hirayama, Hiclave HV-110, JAPAN Certoclav, CV-EL-12L, AUSTRIA
Balance:	Sartorius; BP211D, BP221S, BP610, GERMANY Shimadzu, EB-3200, JAPAN
Blot Module:	Novex, X-Cell II TM Blot, Invitrogen, USA
Centrifuge:	Kendro Lab. Prod., Heraeus 3L, GERMANY Hitachi, Sorvall RC5C Plus, USA Eppendorf; 5415D, 5415R, GERMANY
Deepfreezer:	-80°C, Kendro Lab.Prod., Heraeus, GERMANY -20°C , Bosch, TURKEY
Distilled Water:	Millipore, Elix-S, FRANCE Millipore, MilliQ Academic, FRANCE
Electroporator:	BTX, ECM 630, USA
Electrophoresis:	Bio-Rad Inc., Mini-Protean, USA Biogen Inc., DNA electrophoresis, USA Scie-Plas, Vertical Slab Gel System, UK
Gel Documentation:	Uvitec, UVIdoc, Biolab, UK

	Bio-Rad Inc., UV-Transilluminator, USA
Gel Dryer:	E-C Apparatus Corp., EC355, USA
Hemocytometer:	Marienfeld, Superior, GERMANY
Ice Machine:	Scotsman Inc., AF20, USA
Incubator:	Binder, CO ₂ Incubator, GERMANY Mettler; Modell 300, Modell 600, GERMANY
Laminar Flow:	Kendro Lab. Prod., Heraeus, HeraSafe HS12, GERMANY
Magnetic Stirrer / Heater:	VELP Scientifica, ITALY
Microscope:	Olympus, CK40-F200, JAPAN Olympus, IX70, Phase-Contrast Fluorescence, JAPAN
Microwave Oven:	Bosch, TURKEY
pH Meter:	Fisherbrand, Hydrus 300, UK
Pipette:	Eppendorf, Research, GERMANY Mettler Toledo, Volumate, USA Gilson, Pipetman, FRANCE Pipetus-Akku, Hirschmann Laborgerate, GERMANY
Power Supply:	Wealtec, Elite 300, USA Bio-Rad Inc., PowerPac 300, GERMANY
Radiative-proof Waste Bin:	Scie-Plus, UK
Radiation Monitor:	TAEK, TURKEY
Refrigerator:	+4°C, Bosch, TURKEY
Rotator:	Lab-Line Multitube Rotator, USA Labquake, Barnstead Thermolyne Corp., USA
Shaker:	IKA, Orbital Shaker KS 260 basic, USA New Brunswick Sci., Innova™ 4330, USA
Spectrophotometer:	Bio-Rad Inc., Microplate reader Model 680, USA Shimadzu, UV-3150, JAPAN
Tissue-Cell Culture Products:	TPP, SWITZERLAND
Vortex Mixer:	Velp Scientifica, 2x ³ , ITALY
Water-bath:	Eppendorf, Thermomixer Comfort, GERMANY Huber, Polystat cc1, GERMANY

4. METHODS

4.1 Cell Culture

Human cervix carcinoma cell line, HeLa, is obtained from HUKUK (Ankara, Turkey). Cells are cultured in Eagle's minimum essential medium (MEM) containing all 0,2 µm filter-sterilized fetal calf serum (10% FCS) and penicillin/streptomycin (2% P/S) plus additives L-glutamine and sodium bicarbonate (NaHCO₃) in a humidified atmosphere with 5% CO₂ at 37°C. Penicillin/streptomycin final concentrations are 100 U/ml and 100 µg/ml, respectively. Since L-glutamine is an unstable amino acid, medium is freshly supplemented with L-glutamine just prior to use to a final concentration of 2 mM (0.292 g/L). For optimum pH requirement of mammalian cells (7.2-7.4), pH of the medium is adjusted with additional NaHCO₃, which is missing by 1.85 g/L in the particular MEM used.

When cells are grown to confluency, subculturing to new passage numbers is done with filter-sterilized 1X trypsin/EDTA solution. As soon as cells are detached in 37°C incubator, medium containing serum is added to inhibit further trypsin activity that might damage cells. Cells are counted with a hemacytometer by the following formula:

$$\text{cells/ml} = \text{average count per square} \times \text{dilution factor} \times 10^4 .$$

and equal volumes of cell suspension are passaged to new flasks or dishes in appropriate seeding densities.

4.1.1. Cryopreservation

For long-term storage; cells are cryopreserved as follows: Cells at log-phase growth (at 50-75% confluency) are trypsinized, spun down at 450x g for 3 min and

washed with sterile 1X PBS. Cell pellets are resuspended in freezing medium, which contains 10% tissue culture-grade sterile DMSO, as cryoprotective agent, in FCS alone. Cells in freezing medium are transferred to cryovials, with each vial containing 10^6 - 10^7 cells/ml, equivalent to the seeding density of a 25 cm² flask for HeLa cells. It is essential cells are frozen gradually: initially at -20°C for 15-30 min, then at -80°C for 1 hr to overnight, finally in liquid nitrogen for months to years.

When cryopreserved cells are needed, they are thawed rapidly and washed off residual DMSO with normal growth medium (+10% FCS) before seeded in a 25 cm² flask.

4.2. Cell Treatments

Cells at 90% confluency are starved for 12 hours before treatments for synchronization in starvation medium, MEM with 0,2% FCS plus additives as mentioned above. Then, starved cells are treated with TNF or IL-1 in a time-dependent manner for 15 min, 30 min, 1 hr, 2 hr and 4 hours at a constant final concentration of 20 ng/ml. (6 µl of stock 10 µg/ml TNF or IL-1 onto 60mm dishes containing 3 ml starvation medium and 4 µl of stock 10 µg/ml TNF or IL-1 onto 6-well plates containing 2 ml starvation medium) Starvation prior to treatments is done only with cells, total extracts of which are to be used for the aim of heat shock protein expression profiling or with cells, nuclear extracts of which are to be used for EMSA experiments. Starvation prior to transfection experiments for the aim of immunoprecipitation is not found to be necessary.

Where mentioned (in EMSA experiments), starved cells are pretreated with hsp90-specific inhibitor geldanamycin (GA, Sigma) at a final concentration of 0.5 µM (0.56 µl of stock 1 mg/ml GA in DMSO onto 6-well plates containing 2 ml starvation medium) for 15 hours, prior to TNF or IL-1 treatments and the subsequent nuclear protein extraction.

4.3. Total Protein Extraction

After cells are treated as described above, medium is sucked out immediately. Cells, approximately $3-4 \times 10^6$ at 90-95% confluency in 60mm dishes, are washed with cold 1X PBS, then scraped off the surface of dishes in 1 ml PBS and transferred to 1.5 ml microcentrifuge tubes. Then, cells are spun down by cold (4°C) centrifugation at 13200 rpm for 30 sec. Pellets are resuspended in 200 μ l total lysis buffer (cold), which contains 150 mM NaCl, 1% NP-40 (non-ionic detergent), 50 mM Tris (pH 8.0) and freshly added 1 mM PMSF and one Complete™ protease inhibitor tablet (one tablet is for 50 ml total extraction buffer, yielding 1 mM EDTA and sufficient amounts of diverse protease inhibitors including chymostatin, pepstatin, leupeptin, antipain, aprotinin, bestatin etc.). Cell resuspension is briefly vortexed and kept on ice at least for 30 min, followed by cold centrifugation at 13200 rpm for 10 min. Supernatants contain total protein extracts, which are immediately frozen and stored at -80°C.

4.4. Cytoplasmic/Nuclear Differential Protein Extraction

After cells are treated as described above, medium is sucked out immediately. Cells, approximately $1-2 \times 10^6$ at 90-95% confluency in 6-well plates, are washed with cold 1X PBS, then scraped off the surface of plates in 1 ml PBS and transferred to 1.5 ml microcentrifuge tubes. Then, cells are spun down by cold (4°C) centrifugation at 13200 rpm for 30 sec. Pellets are resuspended in 120 μ l hypotonic Tampon 1 (T1) solution (cold), which contains 10 mM HEPES-KOH (pH 7.9), 2 mM $MgCl_2 \cdot 6H_2O$, 0.1 mM EDTA, 10 mM KCl, 1% NP-40, and freshly added 1mM DTT, 0.5 mM PMSF and Complete™ protease inhibitors. Resuspended cells are kept on ice for at least 20 min, then briefly vortexed, followed by cold centrifugation at 13200 rpm for 1 min. Supernatants contain cytoplasmic proteins extracted. After supernatants are transferred to new microtubes and placed at -80°C, protocol is carried on with the remaining pellets for nuclear lysis. Pellets are resuspended in 20 μ l saline Tampon II (T2) solution (cold),

which contains 50 mM HEPES-KOH (pH 7.9), 2 mM MgCl₂·6H₂O, 0.1 mM EDTA, 50 mM KCl, 400 mM NaCl, 10% (v/v) glycerol, and freshly added 1 mM DTT, 0.5 mM PMSF and Complete™ protease inhibitors. Resuspensions are kept on ice for at least 20 min, followed by cold centrifugation at 13200 rpm for 20 min. Supernatants contain nuclear protein extracts, which are immediately frozen and stored at -80°C.

4.5. Protein Concentration Determination

Protein concentrations in nuclear and total cell extracts are determined by Bradford reagent from Bio-Rad company. Bovine serum albumin (BSA) is used as the standard protein. 0, 2, 4, 6, 8, 10 µl's of 1 mg/ml BSA are taken into one set of tubes, corresponding to 0, 2, 4, 6, 8, 10 µg's of protein, respectively. And into the other set, 2 µl's of protein extract from the unknown samples are taken. 500 µl of (1:6) diluted Bradford reagent is added to both sets of tubes sequentially. As quickly as possible, tubes are mixed by inverting several times, and a volume of 300 µl from every tube is transferred into wells of a 96-well plate. Absorbances are spectrophotometrically measured at 595 nm by a Bio-Rad microplate reader with the first standard set as blank. The standard curve is generated by plotting A₅₉₅ values of BSA (y-axis) versus protein amounts of BSA (x-axis). It is essential the curve is linear with R²-value (correlation coefficient) very close to 1. Protein concentrations in the unknown samples are determined by extrapolating their A₅₉₅ values against the standard curve. For every new assay, a new standard curve is generated.

4.6. Immunoblotting

4.6.1. SDS-PAGE

For both endogenous heat shock protein and overexpressed FLAG-IKKα immunoblots, 30 µg/well total protein extracts are resolved on denaturing (SDS)-discontinuous PAGE, as follows: Bio-Rad Mini Protean SDS-PAGE gel apparatus (for

1mm gel) is assembled according to the manufacturer's instructions. First, 10% separating gel (pH 8.8) is poured; which contains, with the order of addition during preparation, 2.05 ml ddH₂O, 1.25 ml of 1.5 M Tris-HCl (pH 8.8), 25 µl of 20% (w/v) SDS, 1.65 ml of 30% / 0.8% (w/v) acrylamide / bisacrylamide, 25 µl of 10% (w/v) APS and 2.5 µl TEMED. After separating gel polymerizes, 4% stacking gel (pH 6.8) is poured; which contains, again with the order of addition, 1.54 ml ddH₂O, 0.625 ml of 0.5 M Tris-HCl (pH 6.8), 12.5 µl of 20% (w/v) SDS, 0.335 ml of 30% / 0.8% (w/v) acrylamide / bisacrylamide, 12.5 µl of 10% (w/v) APS and 2.5 µl TEMED. (note that recipe is for only one gel). Finally, the comb (for 1mm gel) is inserted gently for the generation of wells into which protein samples are to be loaded.

While stacking gel polymerizes, protein samples are prepared, as follows: to the volume corresponding to 30 µg of total protein extract, exactly the same volume of 2X Laemmli sample buffer (Sigma) is added, and mixture is boiled at exactly 95°C for 3 min. Then, protein samples as well as a pre-stained protein molecular weight marker (5-7 µl) are loaded into wells in 1X running buffer, diluted from 10X running buffer that contains 30.3 g Tris base, 144.1 g glycine and 10 g SDS in 1 liter dH₂O. Proteins are run through the stacking gel at 80-100 V for half an hour, and through the separating gel at 150-180 V for an hour, until the bromophenol blue dye has migrated to the bottom of the gel. When finished, protocol is carried on with blotting of SDS-polyacrylamide gel by wet transfer method.

4.6.2. Wet Transfer

Novex XCell II blotting apparatus is assembled according to the manufacturer's instructions. Briefly, PVDF membrane is pre-wetted in methanol for 30 sec, then rinsed with dH₂O and equilibrated in transfer buffer, which contains 1.45 g Tris base (final: 12 mM), 7.2 g glycine (final: 96 mM), 200 ml methanol (final: 20%) in 1 liter, for several minutes. In the meantime, SDS-polyacrylamide gel is taken out of the gel apparatus and lifted off the glass plate on a pre-soaked Whatman filter paper. PVDF membrane is carefully positioned on the facing side of the gel, without any air bubble trapped in-between. Finally, another pre-soaked filter paper is placed on top of the membrane. Then, the gel-membrane assembly is sandwiched between three pre-soaked blotting pads on both sides, which are altogether placed in the blotting module so that the gel is

closest to the cathode plate (—). The module is then fixed in the tank that is filled only half-way to the top with transfer buffer, whereas the space between the two plates of the module is filled with transfer buffer all the way almost to the top. Transfer is carried out at 25 V overnight at cold room.

4.6.3. Antibody Incubations

On the following day, PVDF membrane is taken out of the blotting module and incubated in blocking solution, which contains 5% (w/v) non-fat dry milk and 0.2% Tween-20 in 1XPBS, for 2 hours at cold room. Then, membrane is very briefly washed with PBS-T (0.2% Tween-20 in 1XPBS) for 10 sec. Membrane incubations in diluted primary antibody solutions (at 1:2000 dilution) are done for 2 hrs at cold room. Primary antibody dilutions are typically prepared in 10 ml solutions (*), which contain 8 ml ddH₂O, 1 ml PBS-T, 1 ml milk diluent blocking solution plus 5 µl of mouse monoclonal antibodies; anti-hsp90 (Abcam, 0.2 mg/ml; final: 0.1 µg/ml), anti-hsp70 (Abcam, stock concentration unknown) or anti-β-actin (Abcam, for the loading control, again stock concentration unknown). After primary antibody incubation, membrane is vigorously washed with PBS-T twice at room temperature (RT), each wash lasting for at least 10 min (2X10 min). Then, membrane is incubated in diluted secondary antibody solution (at 1:5000 dilution) for 1.5 hr at cold room. Secondary antibody dilution is prepared in 10 ml solution, which contains 8 ml ddH₂O, 1 ml PBS-T, 1 ml milk diluent blocking solution plus 2 µl of anti-mouse HRP-conjugated antibody. Then, membrane is vigorously washed with PBS-T three times at RT, each wash lasting for at least 10 min (3X10 min).

4.6.4. Detection

Finally, detection is done by enhanced chemiluminescence (ECL). Membrane is incubated in a mixture, freshly prepared by adding equal volumes (1:1) of Detection Reagent 1 (stable peroxide solution) and Detection Reagent 2 (luminol/enhancer solution), in a dark room for 5 to 20 min until protein bands on the membrane start glowing (Amersham Biosciences). As quickly as possible, membrane is covered with

plastic wrap on both sides, without any bubble trapped inside. Covered membrane is placed in a film cassette, with the protein side facing up. Very carefully and rapidly, a sensitive ECL film (Hyperfilm-ECL, Amersham) is positioned on top of the covered membrane and film is exposed for a period of time that is inversely dependent on the intensity of the light emission. Immediately, film is developed in a developer solution, then fixed in a fixer solution and finally rinsed with tap water.

(*) Anti-FLAG M2 primary antibody is prepared at 1:3333 dilution in 5 ml solution, which contains 4 ml ddH₂O, 0.5 ml PBS-T, 0.5 ml milk diluent blocking solution plus 1.5 µl of mouse monoclonal anti-FLAG M2 antibody (Sigma, 4 mg/ml; final: 1.2 µg/ml). Furthermore, both primary and secondary antibody incubations are done for 1.5 hr at room temperature (RT) -not at cold room- with this antibody.

4.7. Immunoprecipitation

600-800 µg of total cell lysates are taken into 1.5 ml microcentrifuge tubes (see “total protein extraction”). Exactly 1 µg of capture antibody (anti-hsp90, anti-hsp70 or anti-FLAG M2, all mouse monoclonal and of isotype IgG₁) is added to the lysates. The volume in the tubes is completed to 600 µl with total lysis buffer (cold). Then, tubes with caps sealed are mixed gently on rocking platform for 1.5 hr at cold room.

In the meantime, Protein G covalently coupled to sepharose beads are washed for equilibration (the constant F_c portion of mouse IgG₁ binds more strongly to Protein G than to Protein A): A sufficient volume (approx. 180-200 µl for six IP tubes) of Protein G Sepharose suspension (50% slurry) is taken into a microcentrifuge tube. Sepharose beads are washed in 1 ml (cold) total lysis buffer added, and then centrifuged at 13200 rpm for 30 sec at 4°C. Supernatant is carefully removed, without disturbing the bead pellet at the bottom. Washing is repeated once more, but this time supernatant is completely removed with a flat gel-loading tip. Finally, beads are resuspended in (cold) total lysis buffer so that beads and the buffer together make up the same volume as in the beginning.

To microcentrifuge tubes containing lysate/antibody mixtures, equal volumes of washed Protein G Sepharose (50% slurry) suspensions are added. It is essential bead pellet levels at the bottom of the tubes are almost the same (approx. 15-20 µl level).

Then, tubes with caps sealed again are mixed gently on rocking platform for another 2 hrs at cold room. To collect the sepharose beads, which now carry the immunocomplexes of bait protein and the capture antibody, tubes are cold-centrifuged at 13200 rpm for 30 sec. Supernatant is completely removed with flat gel-loading tips, without any loss of sepharose beads. Beads are washed five times with 500 μ l (cold) total lysis buffer. Between each wash, tubes are cold-centrifuged at 13200 rpm for 30 sec and supernatants are completely discarded with flat gel-loading tips.

After the last wash, bead pellets (immunocomplexes) are resuspended in 20-25 μ l 1X Laemmli sample buffer. Then, tubes with caps tightly sealed are boiled at exactly 95°C for 5-7 min to dissociate the complexes. Finally, tubes are centrifuged at 13200 rpm for 1 min at room temperature. Supernatants are loaded on a 10% SDS-polyacrylamide gel, which is followed by immunoblotting, as described before.

PS: The positive control of immunoprecipitation experiment is done by a subsequent immunoblotting with the same primary antibody that has been used as the capture antibody in immunoprecipitation. A protein-protein interaction can be revealed if a different primary antibody recognizing a different protein is used in this immunoblotting, a technique known as “co-immunoprecipitation”. (also see “Discussion”)

4.8. Electrophoretic Mobility Shift Assay

Electrophoretic mobility shift assay (EMSA) is based on reduced electrophoretic mobilities of protein/DNA (radioactively labeled probe) complexes through a non-denaturing polyacrylamide gel compared to unbound (free) labeled DNA probes.

4.8.1. Preparation of Radiolabeled Oligonucleotide Probe

As the first part of the experiment, double-stranded NF- κ B consensus oligonucleotide with 5'-OH blunt ends(*) is radioactively (32 P) labeled in a T4 polynucleotide kinase (Promega) reaction. The reaction mix is assembled in 50 μ l total,

which contains 10.25 μl ddH₂O, 15 μl NF- κ B oligonucleotide (1.75 pmol/ μl , final: 26.25 pmol), 5 μl T4 kinase buffer (10X, final: 1X), 15.75 μl [γ -³²P]ATP (3000 Ci/mmol, 10 mCi/ml; final: 52.5 pmol, 170 μCi) and 4 μl T4 polynucleotide kinase (5 u/ μl , final: 20 units). The mix is incubated in a 37°C waterbath for 10 min.

In the meantime, a G-25 Sephadex column (Roche) to be used for the purification of radioactively labeled oligonucleotide probes out of T4 kinase reaction mix, is washed completely off its buffer first by gravitation, then by centrifugation twice at 3500 rpm (1650x g) for 2 min. Then, 50 μl total mix is carefully applied to the center of the column in an upright position. After the column is placed in a new collection tube, the assembly is centrifuged at 2300 rpm (1100x g) for 4 min. For optimum recovery of the labeled DNA probe, it is essential the eluate after centrifugation is approximately 50 μl again. (If less, the assembly is centrifuged once more at 3500 rpm for 4 min.) Now, the eluate in the collection tube contains purified ³²P-labeled NF- κ B consensus oligonucleotide.

(*) The sequence of double-stranded NF- κ B consensus oligonucleotide is:

5'— AGT TGA GGG GAC TTT CCC AGG C —3'

4.8.2. Binding Reaction

The second part of the experiment is the binding reaction of NF- κ B in nuclear extracts (see “nuclear protein extraction”) onto ³²P-labeled consensus oligonucleotide probes; in other words, the formation of the specific protein/DNA complexes. The binding reaction mix is assembled in 20 μl total, which contains (with the order of addition) ddH₂O⁽¹⁾, 4 μl binding buffer (5X: 100 mM HEPES-KOH, pH 7.9; 5 mM EDTA, pH 7.9; 25% (v/v) glycerol; 25 mM MgCl₂.6H₂O; 0.5 M KCl and freshly added 10 mM DTT; final: 1X), 1 μl NP-40 (2%, final: 0.1%), 3.45 μl glycerol (87%; final: 20%, together with glycerol coming in from 5X binding buffer), 1 μl BSA (1 mg/ml, final: 1 μg), 1.5 μl poly dI-dC—poly dI-dC⁽²⁾ (1 mg/ml, final: 1.5 μg), 5-8 μl nuclear protein extract (the volume corresponding to 5 μg protein) and 1 μl ³²P-labeled NF- κ B oligonucleotide probe⁽²⁾ (taken from 1:20 dilution of column-purified 50 μl eluate⁽³⁾, final: ~0.2 ng). After addition of the labeled probe, binding reaction is allowed to proceed for exactly 30 min at room temperature.

(1) Total volume of the mix is completed to 20 μ l with ddH₂O.

(2) For control of NF- κ B binding specificity, two sets of competition experiments are performed: In one set; 5, 10 and 20-fold molar excesses of poly dI-dC—poly dI-dC are added to the binding reaction mix, as a non-specific competitor oligonucleotide; whereas in the other set, 5, 10 and 20-fold molar excesses of unlabeled NF- κ B consensus oligonucleotide are added to the binding reaction mix, as a specific competitor oligonucleotide.

For control of NF- κ B identity on labeled consensus probes, “supershift” experiment is performed: 1.5 μ l anti-p50 subunit antibody (Santa Cruz, 2 mg/ml; final: 0.15 μ g/ μ l) is added to the binding reaction mix after nuclear protein extract addition, followed by incubation at RT for 30 min. Then, with addition of the labeled probe, mixture is incubated for another 30 min at RT.

(3) The calculation that gives a \sim 0.2 ng/ μ l concentration of labeled oligonucleotide at 1:20 dilution of column-purified eluate depends on the assumption that both T4 polynucleotide kinase reaction and G-25 Sephadex column purification work with 80% efficiency. (Molecular weight of labeled NF- κ B oligonucleotide: \sim 13842 g/mol)

4.8.3. Vertical Gel Electrophoresis

The third part of the experiment is the separation of protein/DNA complexes by non-denaturing polyacrylamide gel electrophoresis. Vertical slab gel apparatus (Sciencelab) is assembled according to the manufacturer’s instructions. 6% non-denaturing polyacrylamide gel is cast; which contains, with the order of addition, 24 ml dH₂O, 10 ml of 1X TBE (1X: 89 mM Tris base, 89 mM boric acid, 2 mM EDTA; diluted from 10X TBE that contains 108 g Tris base, 55 g boric acid and 40 ml of 0.5 M EDTA (pH 8.0) in 1 liter dH₂O), 6 ml 40% / 1% (w/v) acrylamide / bisacrylamide, 280 μ l of 10% (w/v) APS and 36 μ l TEMED. The comb is inserted carefully, and gel is left to polymerize for 45 min. Then, gel is pre-run in 0.25X TBE running buffer (cold) at 180 V for at least 30 min. In the meantime; 3 μ l EMSA loading dye (30% (v/v) glycerol, 0.25% (w/v) bromophenol blue plus HEPES till it gets dark blue) is added to the

binding reaction mixes, which have just completed their 30 min period of incubations at RT. Then, mixtures of protein/DNA complexes are loaded on the gel and run at 300 V for 3 hrs until the bromophenol blue dye has migrated about three-fourths of the distance down the gel.

4.8.4. Detection

Finally, run gel is taken out of the apparatus and lifted off the glass plate on two pre-soaked Whatman filter papers. The facing side of the gel is covered with plastic wrap, and the gel is dried in a gel drier under vacuum at 80°C for 45 min–1 hr. The dried gel is placed in a film cassette with an intensifying screen (Kodak BioMax, 24X30cm). Then, an X-ray film (Kodak BioMax MS) is positioned carefully on top of the gel in a dark room. Dried gel is exposed at -80°C for a period of time that is dependent on the radioisotope (³²P) activity at the date the experiment is conducted. Following autoradiography, the X-ray film is developed in a developer solution, then fixed in a fixer solution and finally rinsed with tap water in a dark room.

4.9. Transfection of HeLa Cells by Electroporation

Approximately $6-7 \times 10^6$ HeLa cells at 75-80% confluency in a 100mm dish are trypsinized and spinned down at 450x *g* for 3 min. Then, cells are washed twice with sterile 1XPBS. After the second wash, cell pellet is resuspended in 300 μ l serum-free RPMI-1640 medium at room temperature.

Separately, to a 1.5 ml microcentrifuge tube, exactly 10 μ g plasmid DNA to be transfected is added at RT (here, pMAX-GFP or pRK7-FLAG-IKK α . Midi-prepared plasmid DNAs are used). It is essential the concentration of the purified plasmid DNA lies between 0.5–2 μ g/ μ l. Then, resuspended cells are transferred onto the plasmid DNA in the tube. Cells and DNA in the tube are gently mixed by tapping, without introducing any air bubbles. The mix is subsequently transferred to an electroporation cuvette (4mm gap, BTX-Cuvettes Plus) at RT. The cuvette is pulsed only once in Electroculture Manipulator (ECM 630-BTX) with the parameters set at 300 V, 500 μ F and 725 Ω .

After the pulse, the cuvette is maintained at RT for a minute. Then, 700 μ l serum-free RPMI-1640 is gently added to the cuvette at RT. Finally, 1 ml cell mixture is transferred with a sterile Pasteur pipette and is plated in a 60mm dish, containing 2 ml normal growth medium (MEM+10% FCS, etc.).

pMAX-GFP-transfected cells are incubated in a 37°C/5% CO₂ incubator and expression of GFP is visualized under inverted fluorescence microscope (Olympus IX70 Phase Contrast) 36 hours post-transfection (excitation: 450nm, emission: 510nm).

pRK7-FLAG-IKK α -transfected cells are incubated in a 37°C/5% CO₂ incubator for 32 hrs before lysed for total protein extraction. Medium is changed with 3 ml fresh normal growth medium 25 hours post-transfection. Starting from 28 hours post-transfection, TNF treatments are done, as described before.

4.10. Transformation

25 ng DNA (here, pMAX-GFP or pRK7-FLAG-IKK α) is added onto ice-thawed 50 μ l competent *E.coli* strain, TOP10 (one-shot ready from Invitrogen), on ice. Tube is gently mixed once and incubated on ice for 30 min. After ice incubation, cells are heat-shocked at exactly 42°C for exactly 90 sec in a waterbath. Then, the tube is immediately transferred on ice for 5 min. 1 ml of prewarmed (37°C) LB liquid (broth) without any antibiotics is slowly added to the tube and cells are incubated in the waterbath set at 37°C for 1 hr without shaking. Finally, 200 μ l of transformed cells are spread onto LB-agar plates containing the appropriate selection antibiotic (kanamycin at 50 μ g/ml for pMAX-GFP, ampicillin at 100 μ g/ml for pRK7-FLAG-IKK α). Plates are incubated at 37°C for 12-16 hours for transformed colonies to appear.

4.11. Midi-Preparation of Plasmid DNA and Restriction Endonuclease Digestions

Following transformation, 30 ml LB broth containing the appropriate selection antibiotic (kanamycin at 50 μ g/ml for pMAX-GFP, ampicillin at 100 μ g/ml for pRK7-FLAG-IKK α) is inoculated with a single transformant colony. After growth at 37°C for

16-18 hours with vigorous shaking (270-300 rpm), plasmid DNAs are prepared according to the manufacturer's instructions (QIAGEN Plasmid Midi Kit 100 Purification Handbook).

Following plasmid midi-preparation, quality and quantity/concentration of the plasmid DNA are checked by agarose gel electrophoresis (1% agarose gel in 0.5X TBE) and spectrophotometry (absorbance at 260 nm with A_{260}/A_{280} ratio close to 1.8).

As a further confirmation for the identities of the plasmid DNAs used in this study (pMAX-GFP and pRK7-FLAG-IKK α), diagnostic restriction endonuclease digestions are performed in a 37°C waterbath for 2-3 hours with the following enzymes; *Spe* I, *Nae* I, *Xba* I, *Hind* III, *Pst* I, *Xho* I, *Sph* I; according to the manufacturer's instructions (Promega) (<http://www.promega.com/techserv/apps/cloning/cloning1.htm>). Digested DNA fragments are run on an agarose gel electrophoresis (1% in 0.5X TBE) and base pairs corresponding to the bands observed are approximately determined with the help of high range and low range DNA markers.

5. RESULTS

5.1. Endogenous Hsp90 and Hsp70 Profiles

Endogenous hsp90 protein levels in untreated and TNF-treated HeLa cells were checked by immunoblotting. TNF treatments were done in a time-dependent manner starting from 15 min up to 4 hrs, at 20ng/ml final concentration. Immunoblotting of total protein extracts with specific anti-hsp90 antibody (at 1:2000 dilution and 0.1 µg/ml concentration) demonstrated that hsp90 *is* upregulated in response to TNF in HeLa cells. Endogenous hsp90 protein levels were found to increase significantly starting from 15 min of TNF stimulation in comparison to those from untreated (control) cells. (Figure 5.1) Equal protein loading was confirmed by immunoblotting the same membrane with anti-β-actin antibody at 1:2000 dilution.

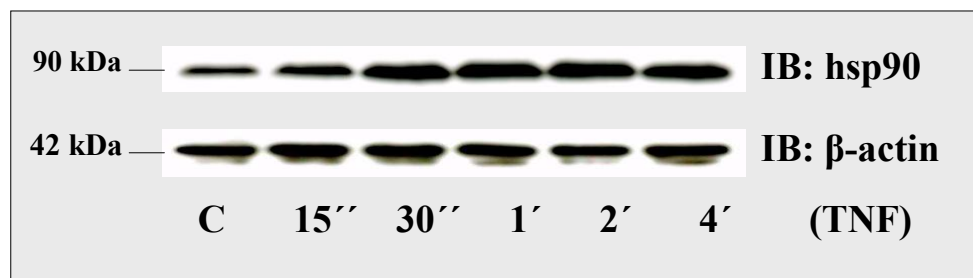

Figure 5.1 Endogenous hsp90 protein levels under time-dependent TNF stimulation (20 ng/ml) (IB: hsp90). Equal protein loading was checked by IB: β-actin.

Similarly, endogenous hsp70 protein levels in untreated and TNF-treated HeLa cells were checked by immunoblotting with specific anti-hsp70 antibody at 1:2000 dilution. Contrary to hsp90, hsp70 does not appear to be upregulated in response to TNF in HeLa cells. Endogenous hsp70 protein levels were not found to be affected

significantly under TNF stimulation in comparison to those from unstimulated (control) cells. (Figure 5.2) Equal protein loading was checked by immunoblotting the same membrane with anti- β -actin antibody at 1:2000 dilution.

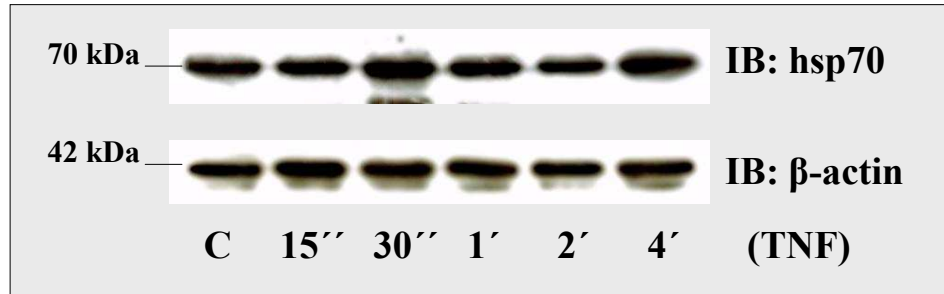

Figure 5.2 Endogenous hsp70 protein levels under time-dependent TNF stimulation (20 ng/ml) (IB: hsp70). Equal protein loading was checked by IB: β -actin.

Likewise, IL-1 stimulation did not cause any change in endogenous hsp70 protein levels in HeLa cells. HeLa cells were treated with IL-1 in a time-dependent manner starting from 15 min up to 4 hrs, at a final concentration of 20 ng/ml. Immunoblotting of total protein extracts with specific anti-hsp70 antibody at 1:2000 dilution revealed that IL-1 stimulation did not have any significant effect on hsp70 protein levels. (Compare with the control lane in Figure 5.3).

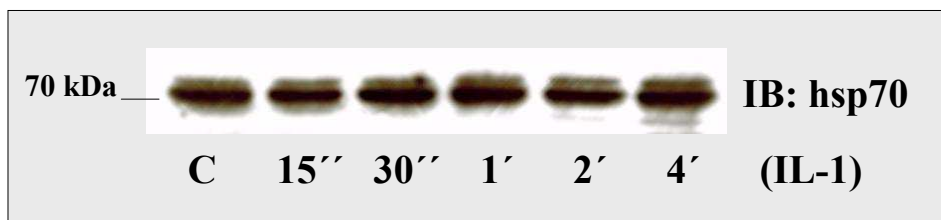

Figure 5.3 Endogenous hsp70 protein levels under time-dependent IL-1 stimulation (20 ng/ml). (IB: hsp70)

5.2. Analysis of NF- κ B Activation

5.2.1. Control of NF- κ B Binding Specificity and Identity

Heat shock protein expression profiling results shown above clearly demonstrate that hsp90, not hsp70, is upregulated in response to TNF in HeLa cells, suggesting a possible involvement of hsp90 at some level in TNF signaling. To further investigate the role hsp90 in TNF signaling; NF- κ B activation, the predominant outcome of TNF signaling, was decided to be analyzed by electrophoretic mobility shift assay (EMSA) in presence of the hsp90-specific inhibitor geldanamycin (GA). However, prior to GA experiments, a series of control experiments were performed to ensure NF- κ B binding specificity and identity for the subsequent electrophoretic mobility shift assays.

For control of NF- κ B binding specificity to radiolabeled consensus oligonucleotides, two sets of competition experiments were carried out with nuclear protein extracts of HeLa cells that were only treated with TNF for 30 min. In addition to its previously described contents (see “Methods”); one set of binding reaction mixes included 5, 10 and 20-fold molar excesses of the non-specific competitor DNA, poly dI-dC—poly dI-dC; whereas the other set included 5, 10 and 20-fold molar excesses of the specific competitor DNA, unlabeled NF- κ B consensus oligonucleotide. Increasing concentrations of the specific competitor DNA resulted in a decrease in the intensity of the control TNF-30 min band, which is much sharper than that observed with the increasing concentrations of the non-specific competitor DNA. (Compare lane 3 with lanes 4-6 and with lanes 7-9 in Figure 5.4) These two sets of competition experiments clearly demonstrated sequence-specific DNA binding of NF- κ B in nuclear extracts.

For control of the identity of NF- κ B bound to radiolabeled consensus oligonucleotides, anti-p50 subunit antibody was added to the binding reaction mix just after addition of the nuclear protein extracts of TNF-treated (30 min) HeLa cells. Antibody/protein immunocomplexes were allowed to form at RT for 30 min. Then, following the addition of 32 P-labeled NF- κ B consensus oligonucleotide, mixture was incubated for another 30 min at RT, this time for the formation of specific protein/DNA

complexes. Usually, addition of NF- κ B antibody to the binding reaction mix is expected to produce a more slowly migrating complex that is larger in molecular weight than the original protein/DNA complex, a phenomenon known as “supershift”. However, here, pre-incubation of nuclear extracts with NF- κ B antibody did not result in any further shift in the position of the complex, compared to the position of the control TNF-30 min band. On the contrary, this application resulted in almost complete loss of protein/DNA complex formation, a plausible reason of which will be discussed in the next section. (Compare lane 3 with lane 11 in Figure 5.4)

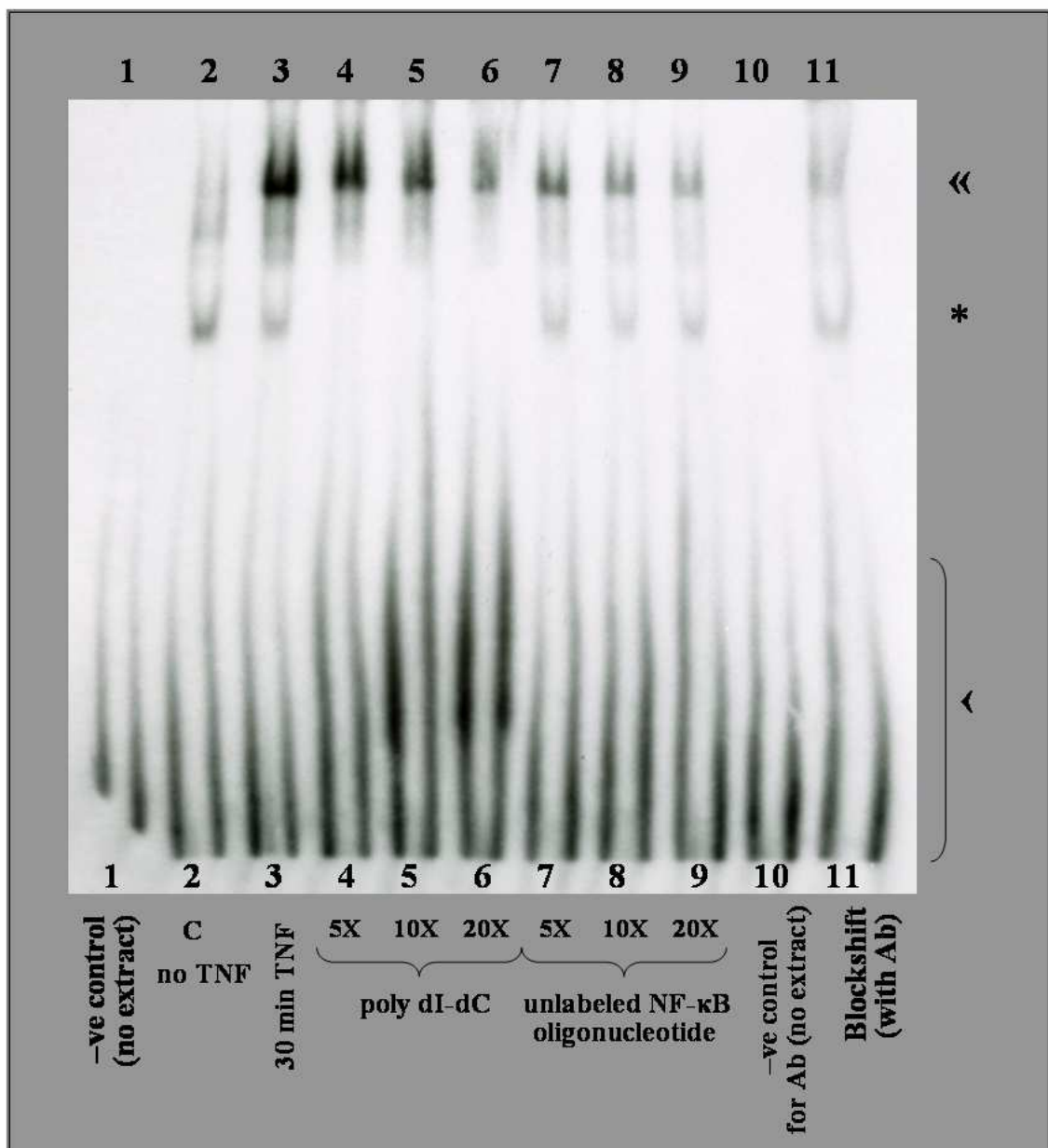

Figure 5.4 Two sets of control experiments, confirming NF- κ B binding specificity and identity in EMSA. All lanes, except lane 1 and lane 10, contain nuclear extracts of samples treated with TNF for 30 min. (no TNF stimulation for lane 2) (◀ indicate the positions of specific NF- κ B complexes, whereas * indicate non-specific complexes and < indicate free oligonucleotide probes)

5.2.2. Effect of Geldanamycin on TNF/IL-1-Induced NF- κ B Activation

After the binding specificity and the identity of NF- κ B were established for EMSA, GA experiments were performed to investigate the role of hsp90 in TNF-induced NF- κ B binding and activation. HeLa cells were pretreated with GA at a constant final concentration of 0.5 μ M for 15 hrs. Then, cells were stimulated with TNF at the same concentration, 20 ng/ml, and for the same durations mentioned above. During TNF treatments, GA was still present in the starvation medium. Nuclear protein extracts were incubated with 32 P-labeled NF- κ B consensus oligonucleotide that was used as an autoradiography probe for EMSA. Nuclear extracts of cells pretreated with GA showed *significantly lesser* amounts of NF- κ B-bound DNA complexes in comparison to those of cells treated only with TNF, as revealed by EMSA. In the absence of GA pretreatment, TNF-induced NF- κ B activation was detected starting from 15 min of TNF stimulation up to 4 hrs. However, GA pretreatment resulted in severe impairment of NF- κ B binding to radiolabeled consensus oligonucleotides, suggesting that inhibition of hsp90 by GA blocks TNF-induced activation of NF- κ B in HeLa cells. (Figure 5.5)

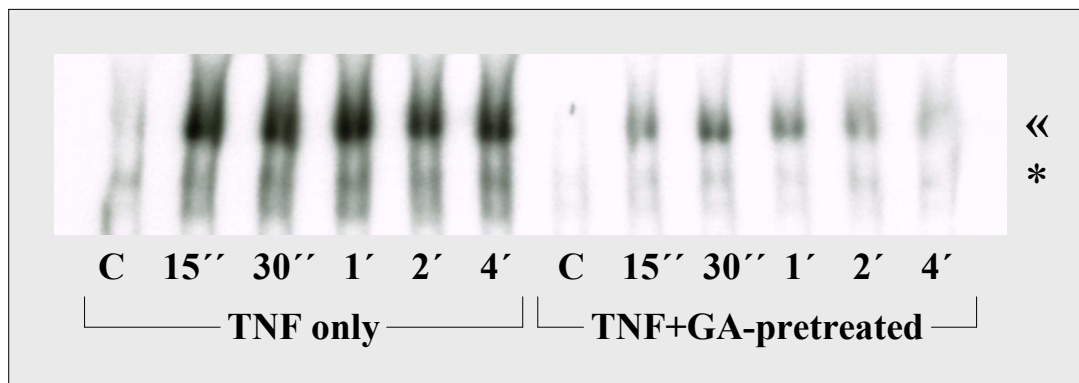

Figure 5.5 Effect of geldanamycin pretreatment (at 0.5 μ M for 15 hrs) on TNF-induced NF- κ B activation. (◀ indicate the positions of specific NF- κ B complexes)

Consistently, the results were similar for the case of IL-1 stimulation, as well. HeLa cells were either left untreated or treated with 0.5 μ M GA for 15 hrs, before they were all stimulated with IL-1 at 20 ng/ml for the indicated time periods mentioned above. Electrophoretic mobility shift assays performed by incubating nuclear protein extracts with 32 P-labeled NF- κ B consensus oligonucleotides showed *significantly reduced* NF- κ B binding to radiolabeled probes for GA pretreated samples, when compared to IL-1-only treated samples. In the absence of GA pretreatment, IL-1-induced NF- κ B activation was detectable starting from 15 min of IL-1 stimulation up to 4 hrs. However, GA pretreatment ended up with abrogation of NF- κ B binding to radiolabeled consensus oligonucleotides, suggesting that inhibition of hsp90 activity by GA prevents IL-1-induced activation of NF- κ B in HeLa cells. (Figure 5.6)

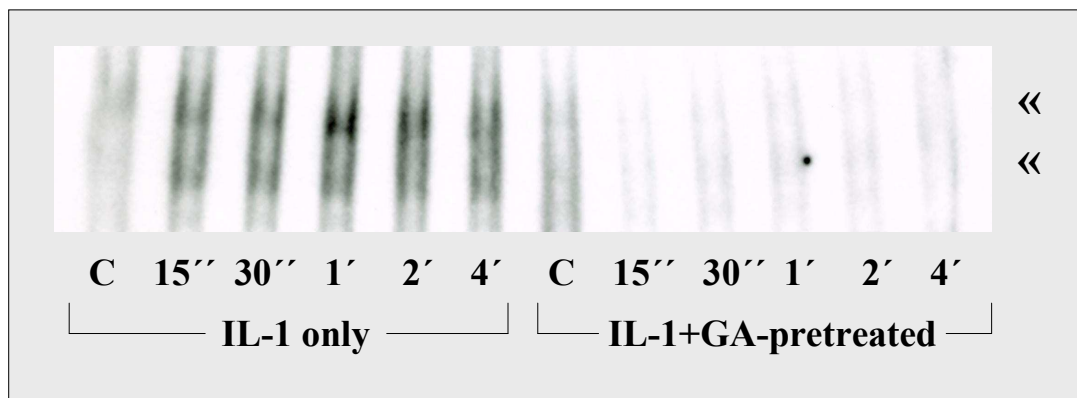

Figure 5.6 Effect of geldanamycin pretreatment (at 0.5 μ M for 15 hrs) on IL-1-induced NF- κ B activation. (◀◀ indicate the positions of specific NF- κ B-p65 and p50 subunits-complexes)

5.3. High Efficient HeLa Transfection

After identification of hsp90 involvement in TNF/IL-1-induced NF- κ B activation, next step was to investigate for hsp90-interacting proteins in TNF and IL-1 signaling pathways. For this aim, protein-protein interactions of hsp90 with several components (receptors, kinases, adaptors, etc.) of these two pathways were decided to be analyzed by co-immunoprecipitation (co-IP) assays.

Since kinases are of minute amounts in cells, an efficient transfection protocol was a pre-requisite for successful co-IP assays to ensure sufficient immunoprecipitation of tagged protein kinases. Therefore, transfection of HeLa cells was optimized first, by using pMAX-GFP vector. Cells were transfected via electroporation with this plasmid(*), then were visualized for GFP expression, 36 hrs post-transfection under fluorescence microscope (excitation: 450nm, emission: 510nm). Approximately 95% of attached, viable HeLa cells that survived the electropulse were expressing GFP, proving the optimized transfection protocol to be a highly efficient one. (Compare the two images taken from the same region below: Figure 5.7 was taken under fluorescent light with appropriate filters and Figure 5.8 was taken under visible light.)

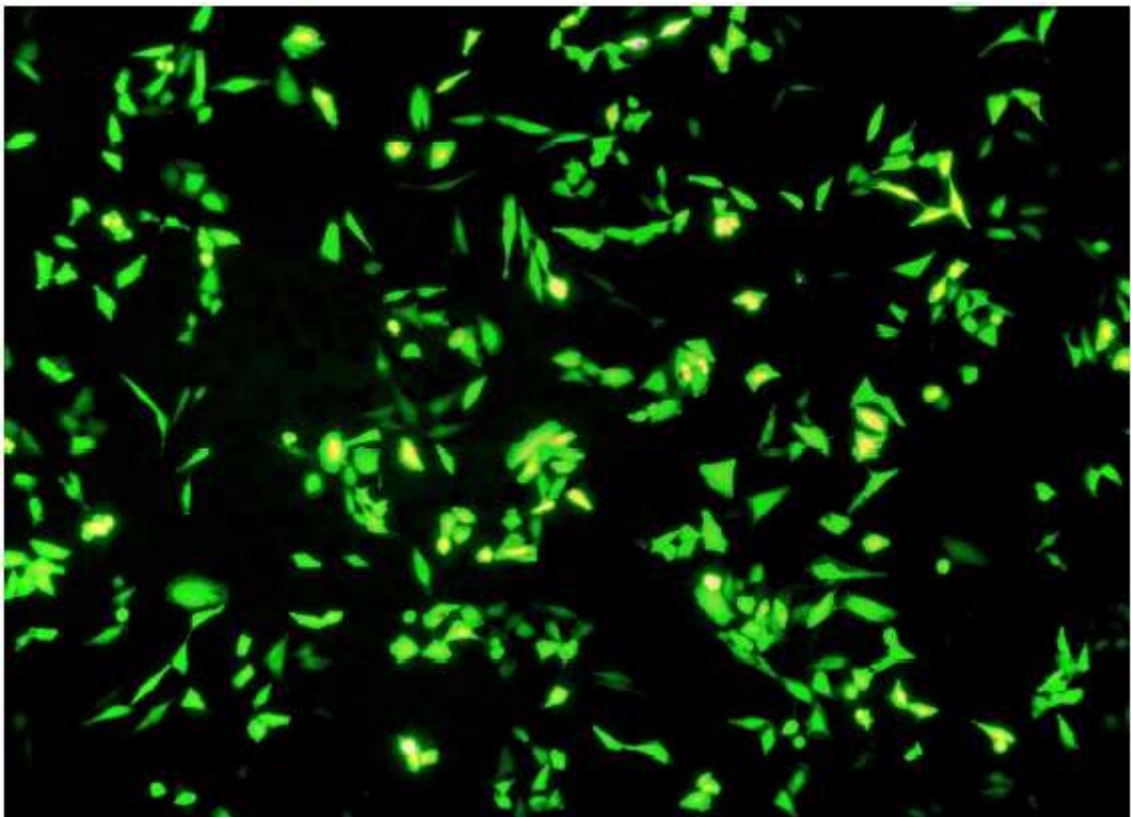

Figure 5.7 View of GFP-transfected HeLa cells under fluorescence microscope. (100X magnification; excitation: 450nm, emission: 510nm)

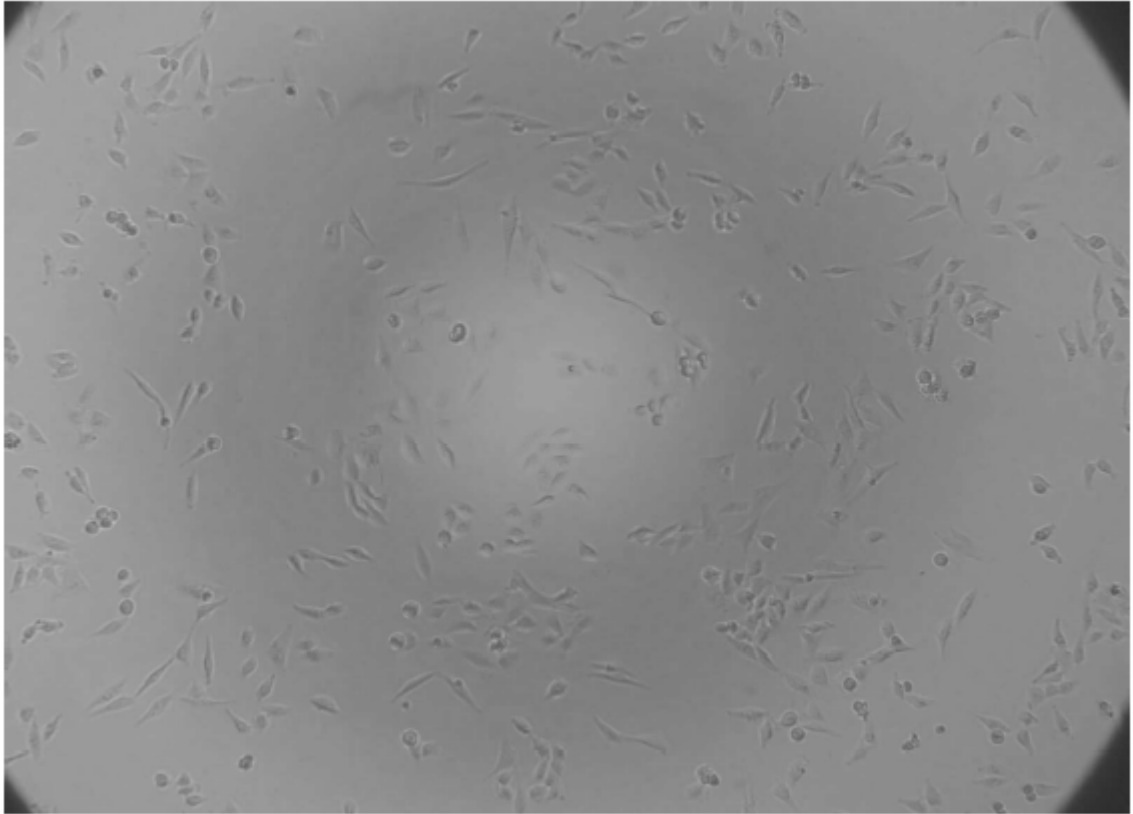

Figure 5.8 View taken from the same region as Figure 5.7 under visible light.

After optimization of transfection with GFP, HeLa cells were transfected with pRK7-FLAG-IKK α vector(*) in the same manner, except that the number of cells to be transfected was increased up to $6-7 \times 10^6$ cells/cuvette. Following transfection, cells were treated with TNF at 20 ng/ml final concentration in a time-dependent manner, starting from 28 hrs post-transfection, as described before. Transfected FLAG-IKK α protein expression levels were checked by immunoblotting of total protein extracts with specific anti-FLAG M2 antibody at 1:3333 dilution and 1.2 μ g/ml final concentration. Immunoblotting result showed sufficient amounts of FLAG-IKK α protein expressed in transfectant cells, confirming the efficiency of transfection. (Figure 5.9)

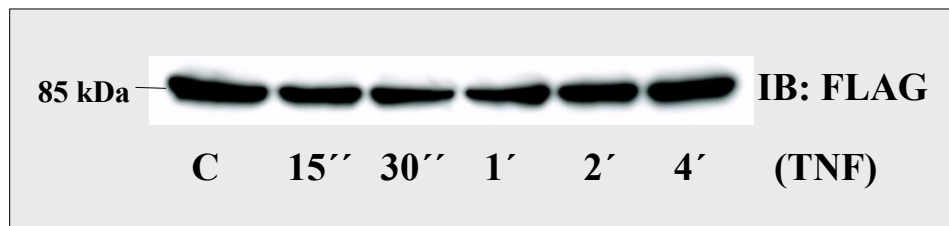

Figure 5.9 FLAG-IKK α levels, confirmation of the efficiency of transfection (IB: FLAG).

(*) Plasmid DNAs to be transfected (pMAX-GFP and pRK7-FLAG-IKK α) were midi-prepared and checked by agarose gel electrophoresis and spectrophotometry. Diagnostic restriction endonuclease digestions were performed beforehand for confirmation of the identities of the vectors (data not shown).

5.4. Analysis of Protein-Protein Interaction

To check applicability of anti-FLAG M2 antibody for immunoprecipitation assay and as a control for the subsequent co-IP assay, FLAG-IKK α was immunoprecipitated and immunoblotted with the same anti-FLAG M2 antibody: After transfections and TNF treatments were done as described above, FLAG-IKK α protein was immunoprecipitated out of total protein extracts by 1 μ g anti-FLAG M2 antibody (mouse monoclonal IgG₁). Immunocomplexes formed were dissociated by boiling in Laemmli sample buffer at 95°C and were resolved on a 10% SDS-polyacrylamide gel. Subsequent immunoblotting analysis with the same anti-FLAG M2 antibody (at 1.2 μ g/ml concentration) demonstrated that the antibody works for IP as well and sufficient amounts of transfected FLAG-IKK α were able to be immunoprecipitated by this method. (Figure 5.10)

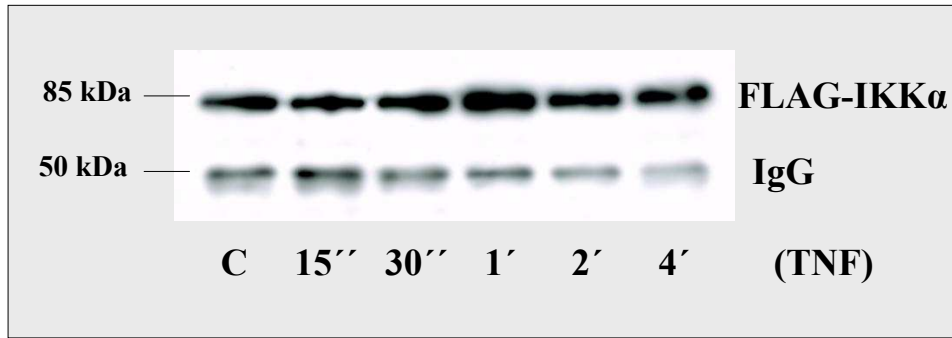

Figure 5.10 Immunoprecipitation of FLAG-IKK α from TNF-stimulated transfectant cells. (IP: FLAG, IB: FLAG)

As an alternative control for the subsequent co-IP assay and also to check applicability of the antibody for IP assay, endogenous hsp90 was immunoprecipitated and immunoblotted with the same anti-hsp90 antibody: After cells were treated with TNF or IL-1, as described before; endogenous hsp90 was immunoprecipitated out of total protein extracts by 1 μ g anti-hsp90 antibody (mouse monoclonal IgG₁). After immunocomplexes formed were dissociated as mentioned above, immunoblotting analysis was performed by the same anti-hsp90 antibody (at 0.1 μ g/ml concentration). Results demonstrated that the antibody works for IP as well and sufficient amounts of endogenous hsp90 were able to be immunoprecipitated by this method. (Figure 5.11 and Figure 5.12)

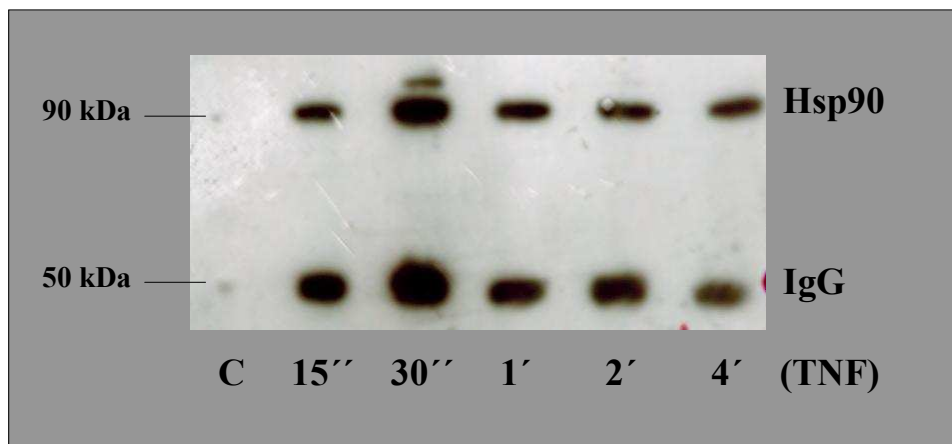

Figure 5.11 Immunoprecipitation of endogenous hsp90 from TNF-stimulated cells. (IP: hsp90, IB: hsp90)

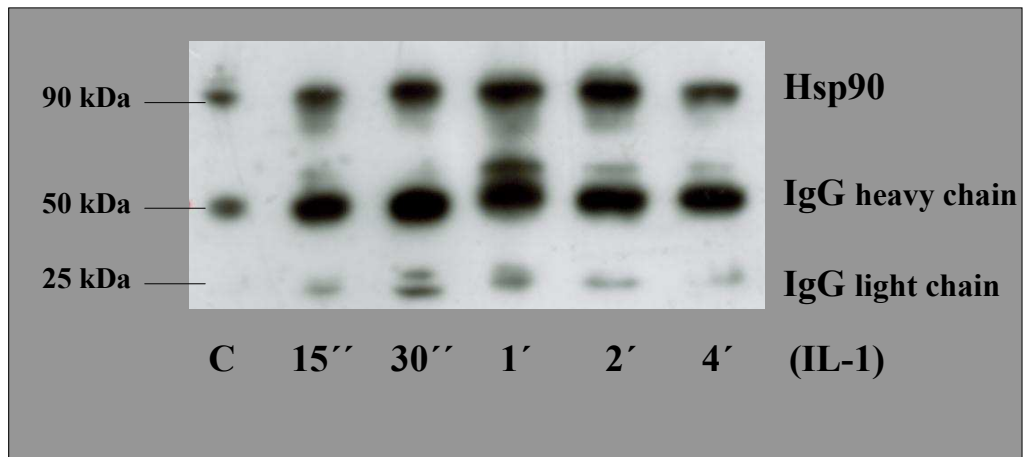

Figure 5.12 Immunoprecipitation of endogenous hsp90 from IL-1-stimulated cells. (IP: hsp90, IB: hsp90)

Finally, co-IP assay was performed by immunoprecipitation of transfected FLAG-IKK α protein from total protein extracts with 1 μ g anti-FLAG M2 antibody, followed by immunoblotting of dissociated immune complexes with 0.1 μ g/ml anti-hsp90 antibody. Result of co-IP assay demonstrated that the bait FLAG-IKK α protein was unable to precipitate endogenous hsp90, several possible reasons of which will be discussed in the next section. (Figure 5.13)

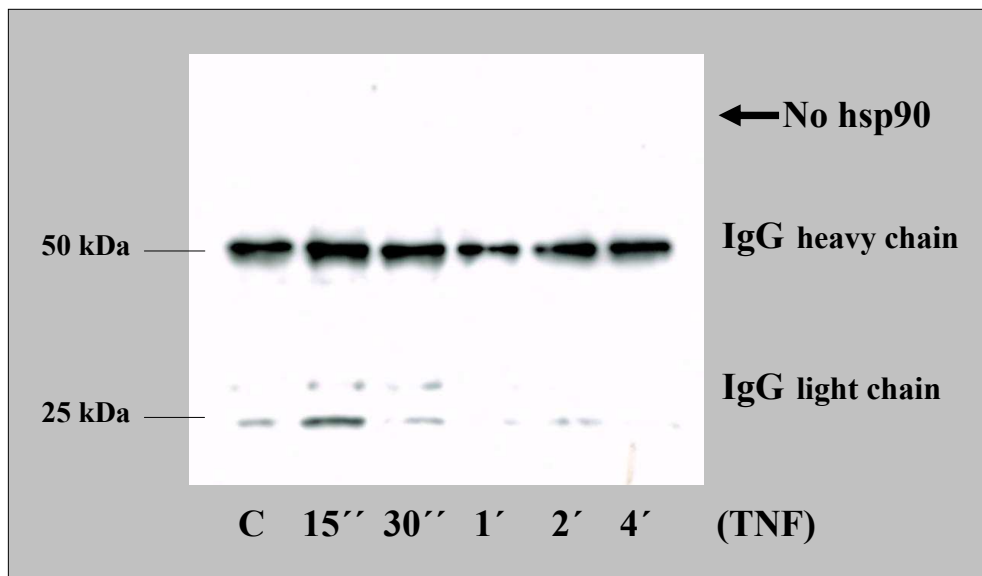

Figure 5.13 Co-immunoprecipitation of FLAG-IKK α and hsp90 from TNF-stimulated transfectant cells. (IP: FLAG, IB: hsp90)

6. DISCUSSION

Hsp90, one of the most abundant cytosolic proteins in eukaryotic cells, plays key roles in stabilization, activation, maturation (to functionally-competent states) and trafficking of proteins involved in signal transduction, cell cycle control, development and transcriptional regulation. As shown in this study, TNF/IL-1-induced NF- κ B activation is one of these signaling events that highly depend on hsp90 activity.

Endogenous hsp90, not hsp70, is found to be upregulated in response to TNF in HeLa cells. Even though hsp upregulation has been previously reported in a wide variety of tumor cells, the molecular mechanisms behind are yet poorly understood (see “HSF-1” under section 1.2.3.2.4.). Given that hsp90 is *not* an NF- κ B target gene [321] and HSF-1 status in HeLa cell line is *not* known, the question how hsp90 is upregulated under TNF induction in HeLa cells remains to be answered by future studies.

Pretreatment of HeLa cells with geldanamycin (GA), the specific inhibitor of hsp90 ATPase activity, blocks NF- κ B binding and activation in response to TNF or IL-1, as demonstrated by electrophoretic mobility shift assays. To confirm that the signaling pathway by which TNF/IL-1 induces NF- κ B activation is blocked by GA, protein level and phosphorylation status of I κ B α could have been analyzed by immunoblotting and *in vitro* kinase assay, respectively. Since IKK-mediated phosphorylation-dependent degradation of I κ B α is essential for TNF/IL-1-induced NF- κ B activation, immunoblotting of total protein extracts with specific anti-I κ B α antibody would be expected to result in no decrease in I κ B α levels for GA-pretreated samples. In other words; in presence of GA, I κ B α would be protected from TNF/IL-1-induced degradation. Consistently, *in vitro* phosphorylation of exogenous GST-I κ B α by IKK, immunoprecipitated from GA-pretreated TNF/IL-1-stimulated cells, would be expected to be completely abolished.

Competition experiments performed with increasing concentrations of unlabeled specific and non-specific competitor oligonucleotides clearly identified sequence-

specific DNA binding of NF- κ B protein. NF- κ B binding specificity could have been displayed more certainly with increasing concentrations of specific unlabeled mutated oligonucleotides, which only differ from consensus NF- κ B oligonucleotides by one or two nucleotides in the binding site that is known to disrupt function and binding. Unfortunately, we did not have such mutated oligonucleotides in our laboratory.

Interestingly, control of NF- κ B identity experiment, done by pre-incubation of nuclear protein extracts with anti-p50 subunit antibody, did not result in a “supershift” of protein/DNA complexes. Instead, this application caused loss of protein/DNA complex formation, almost completely abolishing the shifted bands. This was very likely due to interference of antibody binding with the DNA binding site of NF- κ B protein. Antibodies raised against DNA binding domains of proteins intervene in formation of protein/DNA complexes, resulting in complete loss of binding; a phenomenon known as “blockshift”. Yet, this was still sufficient to prove NF- κ B identity on radiolabeled consensus oligonucleotides. Supplementary experiments with different anti-p50 and anti-p65 antibodies recognizing different epitopes on NF- κ B could have been useful, but unfortunately we did not have such antibodies in our laboratory. Finally, an additional control for electrophoretic mobility shift assays with GA-pretreated and –untreated TNF/IL-1-stimulated samples could have been performed with an unrelated transcription factor known to be unaffected by TNF/IL-1 or GA.

Among the other parameters that had to be carefully optimized for successful EMSA experiments, were ionic strength of the binding reaction buffer (low-stringent buffers can lead to non-specific protein-DNA interactions, whereas high-stringent buffers can even disrupt specific protein/DNA complexes), amount of 32 P-labeled NF- κ B oligonucleotide probe in the reaction mixes (too much of labeled probe can cause high background in X-ray films during autoradiography), percentage of glycerol in the binding reaction mixes (low percentages of glycerol leads to trapping of labeled probes in the wells of the non-denaturing gel), temperature and duration of the binding reaction (longer periods of incubations or incubations at lower temperatures other than RT results in massive amounts of non-specific protein/DNA complexes, in the particular case of NF- κ B binding; whereas incubations at higher temperatures reduce *in vitro* stability of protein/DNA complexes) and period of exposure of 32 P radioisotope in a cassette with an intensifying screen.

After EMSA experiments, as a requirement for the subsequent co-immunoprecipitation assays, a highly-efficient transfection protocol was established for

HeLa cells via electroporation. Initial transfection experiments were performed by a cationic lipid-based non-liposomal transfection reagent called FuGENE 6™ (Roche) according to the manufacturer's instructions. However, efficiency of transfection with this reagent was very low for HeLa cells (data not shown). In agreement with this finding, Roche frankly announced inefficiency of their product for transfection-resistant cell lines such as HeLa and Jurkat, and introduced a new product called "X-tremeGENE Q2" for transfection of these cell lines.

That was the reason why I focused on electroporation for efficient transfection of HeLa cells. Strength of the applied electric field that depends on the parameters such as voltage, capacitance and resistance (which substantially influence cell viability after the electropulse); number of cells per cuvette; ionic strength and volume of the electroporation medium; temperature; amount, concentration and purity of the plasmid DNA to be transfected; inclusion of some additives such as DMSO or FuGENE 6 in the electroporation medium were among the parameters that had to be carefully optimized for efficient transfection of HeLa cells. Following transfection, incubation time of cells was optimized for sufficient transient expression of transfected protein, prior to total protein extraction for the IP/co-IP assay.

It is noteworthy to mention here several superiorities of electroporation over lipid-based transfection reagents: transfection via electroporation is much more efficient (approximately 95%), more effective, much cheaper and has a wider area of applications (siRNA, single-stranded oligonucleotides, etc) in comparison to lipid-based systems. Furthermore, cytotoxicity caused by prolonged exposure of cells to lipid-based reagents is not an issue for electroporation.

After establishment of the high-efficient transfection protocol, protein expression levels were checked by immunoblotting of total protein extracts for the transfected protein. (IB: FLAG, for FLAG-IKK α) Expression levels were quite high and appropriate for the subsequent IP experiments. Alternatively, *in vivo* expression levels of transfected protein could have been checked by immunofluorescence, using anti-FLAG M2 as the primary antibody and fluorochrome (eg. FITC)-conjugated anti-mouse as the secondary antibody.

As a control for co-IP experiment, immunoprecipitations of endogenous hsp90 and overexpressed FLAG-IKK α were performed separately. Amount and volume of the total protein extract to start with, amounts of the capture antibodies and Protein G sepharose beads, number of washes and washing conditions (incomplete removal of

supernatants between each wash may result in high-background of non-specific proteins) were among the parameters that had to be carefully optimized. Pre-clearing of total protein extract with Protein G sepharose matrix did not have any effect on IP efficiency, thus was omitted in the following assays. Absence of non-specific interactions between Protein G sepharose matrix and the proteins in total extracts might be due to relatively inert nature of the matrix.

Following IP assay, dissociated immune complexes were resolved on SDS-polyacrylamide gel and immunoblotted with the same antibodies that had been used as capture antibodies during immunoprecipitation. Ideally, primary antibody of immunoblotting must be raised in a different species than the one in which capture antibody of immunoprecipitation is raised. Otherwise, light and heavy chains of the immunoglobulin used in IP appear in IB as 25 kDa and 50 kDa bands, respectively; obscuring other proteins with similar molecular weights. Fortunately, this was not an issue in the particular cases of hsp90 and IKK α that are 90 kDa and ~85 kDa proteins, respectively. This explains why heavy chains and sometimes light chains of immunoglobulins were observed in IP-followed by-IB results shown in the previous section.

Co-immunoprecipitation assay done in this study did not reveal FLAG-IKK α to be an hsp90-interacting protein. (IP: FLAG, IB: hsp90) However, a previous study by Chen et al. [320] demonstrated that hsp90 and its “kinase-specific” co-chaperone p50/cdc37 associates stoichiometrically with the IKK complex, directly interacting with the IKK α and IKK β kinase domains. They also showed that disruption of this interaction by geldanamycin (GA) abolishes TNF-induced recruitment of the IKK complex to TNF-R1 and prevents activation of IKK kinase activity, which may account for the reason why TNF-induced NF- κ B activation is blocked in presence of GA, as also shown in this study. (Figure V.4) (see below)

There may be several reasons for the failure of the co-IP assay: First of them would be insufficient expression levels of the proteins of interest *in vivo*. However, this possibility was ruled out in this study, because high protein expression levels of both hsp90 and FLAG-IKK α were confirmed with IB before the co-IP assay. Moreover, individual IP assays were optimized so as to give sufficient amounts of immunoprecipitated proteins for each case, without any significant background. Consistently, co-IP assay done showed no background at all. Therefore, one possibility for the loss of hsp90–IKK α interaction in our case might be due to high stringency of

the buffer used during co-IP. Milder buffers may yield higher backgrounds, whereas high-stringent buffers can dissociate the interacting proteins from the immunoprecipitated complex in co-IP assays. Therefore, this finding suggests that hsp90–IKK α interaction is rather a weak interaction because it could not survive the stringency of the total lysis buffer used in this study (medium-stringent). Hsp90 interactions are actually weak for the most of the time (personal communication with Csaba Soti), in consistency with the above finding. For the future studies, less-stringent conditions during both cell lysis (eg. total protein extraction by quick steps of freezing-thawing in a mild lysis buffer) and co-immunoprecipitation (eg. formation of immunocomplexes and subsequent washing steps in a low-stringent buffer) as well as longer incubations of total protein extracts with the capture antibody and Protein G Sepharose (eg. overnight incubations at cold room) are recommended as possible solutions.

Alternatively, failure of detecting an interaction between hsp90 and FLAG-IKK α might be due to hindrance of the hsp90-interacting domain of IKK α by the capture antibody (anti-FLAG M2) during the co-IP assay. If this is the case, C-terminal FLAG-tagged IKK α can be used instead of the present N-terminal FLAG-tagged IKK α to invert the protein and make it readily accessible for hsp90. Reciprocal-co-IP could be another effective solution to address this problem. (IP: hsp90, IB: FLAG)

As control for specificity of the co-IP assay, an antibody directed against an unrelated protein can be added to the total protein extracts in a different microcentrifuge tube. It is essential this control IgG is from the same species and of the same type as the actual capture antibody. (eg. mouse monoclonal as anti-FLAG M2) Additionally, negative controls for co-IP should be included, in which untransfected or empty vector-transfected (mock) cells will be assayed for protein-protein interaction together with the actual transfectant cells. After interaction of hsp90 with wild type FLAG-IKK α is successfully demonstrated, specificity of this interaction should further be confirmed by loss of interaction if cells are to be transfected with a mutant (dominant-negative) form of FLAG-IKK α .

It is noteworthy to mention here that any interaction shown by co-IP assay does not necessarily mean a direct interaction between proteins of interest. The possibility of involvement of bridging factor(s) can not be ruled out unless the interaction is demonstrated between purified proteins *in vitro*. To make things worse, all of these may not necessarily mean the interaction is taking place *in vivo*. Therefore, for confirmation

of an interaction identified by co-IP assay, co-localization of the interacting proteins should be demonstrated *in vivo*, by using confocal microscopy.

One last limitation of co-IP assay would derive from the cliché objection that systems in which proteins are overexpressed do not truly reflect the actual situation *in vivo*. Co-immunoprecipitation of endogenous proteins from untransfected cell lines could bypass overexpression of proteins, promote more native subcellular localizations and post-translational modifications and eliminate foreign tag sequences (eg. FLAG, HA, myc etc). However, for most applications co-IP of endogenous proteins is practically not possible due to insufficient levels of expression for both proteins of interest and/or lack of high-quality capture antibodies (utilization of ordinary antibodies may result in a high background when endogenous proteins are co-IPed; which also accounts for the reason why IPs are preferentially performed with antibodies directed against the foreign tags of overexpressed proteins).

In fact, in the particular case of hsp90, search for hsp90-interacting proteins could have been facilitated by the help of GA before trying out co-immunoprecipitation experiments. As mentioned before, hsp90 functions mainly by stabilizing components of signal transduction, protecting them from proteasome-mediated degradation. However, GA locks the hsp90 multichaperone complex in mimicry of ADP-bound conformation, targeting the bound client proteins for degradation. Therefore, to search for hsp90-interacting proteins in TNF signaling, cells could have been pretreated with increasing concentrations or durations of GA prior to stimulation with TNF. Then protein expression levels of components of the signaling pathway could have been checked by immunoblotting. GA-sensitive proteins, which display decreasing levels of expression with increasing concentrations or durations of GA, would be the putative hsp90-interacting proteins. For confirmation of GA effect on protein stability, half-lives of these proteins could have been examined in absence and presence of GA by [³⁵S]methionine pulse-chase analysis. Then, at this point, co-IP assays could have been performed for confirmation of hsp90 interaction, as described before.

One study done in such an experimental order by Lewis et al. [319] has revealed RIP as an hsp90-interacting protein—the first component of TNF signaling pathway that has ever been shown to interact with hsp90. According to this study, GA pretreatment causes rapid degradation of RIP, resulting in TNF-induced assembly of TNF-R1 complex lacking RIP. Since RIP is known to be a required factor for activation of the IKK complex; destabilizing effect of GA on RIP leads to loss of IKK activation, as

demonstrated by *in vitro* kinase assays where phosphorylation of GST-I κ B α by IKK, immunoprecipitated from GA-pretreated TNF-stimulated cells, is abolished. This may account for another reason why GA blocks TNF-induced NF- κ B activation (Figure V.5), the outcome of which has been shown as enhanced sensitization of cells to TNF-induced apoptosis in the same study. Actually, the reason why Chen et al. [320] could not observe any IKK activity in presence of GA can be attributed to destabilizing effect of GA on RIP (see above).

Interestingly, Chen et al. [320] also reported that GA abolishes TNF-induced recruitment of the IKK(β) complex to TNF-R1. In GA-treated cells, TNF-dependent recruitment of IKK β , hsp90 and RIP to TNF-R1 is fully abrogated; whereas recruitment of TRAF2 and TRADD to TNF-R1 does not seem to be affected. As being a GA-sensitive protein [319], defective recruitment of RIP to TNF-R1 is very likely due to its rapid degradation in presence of GA. However, the observation that GA abolishes IKK β recruitment to TNF-R1, even though IKK β is *not* a GA-sensitive protein, suggests a new role for hsp90, as discussed below.

Traditionally, TRAF2 alone has been known to be sufficient for TNF-induced recruitment of the IKK complex to TNF-R1 signaling complex (TNF-R1-TRADD), without any requirement for RIP in the process. However, in presence of GA, recruitment of TRAF2 and TRADD to TNF-R1 has not been sufficient for shuttling of IKK β to the membrane despite its abundance in the cytosol. The observation that GA does not affect TRAF2 or TRADD recruitment to TNF-R1 is in agreement with the previous observation by Lewis et al. [319] that neither TRAF2 nor TNF-R1 is GA-sensitive.

These findings together suggest an emerging new role for hsp90 in trafficking of the IKK complex from cytosol to TNF-R1 complex at plasma membrane. Interacting both with RIP [319] and the IKK(α,β) complex [320], hsp90 may serve as a bridging factor between the upstream components of TNF signaling. Since TRAF2 is indispensable for recruitment of the IKK complex to TNF-R1 complex, while RIP is dispensable; it is tempting to presume the whole process as the following: In unstimulated cells, TRAF2 interacts with hsp90, which also can interact with the IKK complex. Upon TNF stimulation, the IKK complex is recruited to TRADD of TNF-R1 complex at the plasma membrane via hsp90-bound TRAF2. Hsp90, now in the vicinity of the membrane, recruits RIP onto TNF-R1 complex via direct interaction, which in turn triggers the activation of the proximal IKK complex.

In the above scenario, interaction of hsp90 with TRAF2 is the only one that has not been demonstrated yet. The finding that TRAF2 protein levels remain unaffected in presence of GA may sound rather discouraging in the search for such an interaction. However, GA-mediated degradation of hsp90 client proteins does not seem to be a generic rule. In other words, it seems possible for a protein to interact with hsp90 and stay still stable in presence of GA: Although the IKK(α,β) complex has been shown to interact with hsp90 by Chen et al., GA treatment has had no apparent effect on IKK protein(α,β,γ) levels in HeLa cells [320]; whereas a recent study by Broemer et al. [322] has demonstrated significant depletion of IKK proteins(α,β) under GA treatment in lymphoma cells. These findings suggest that hsp90 effect on the stability of its client proteins may be cell type-specific.

The exact mechanisms of recruitment of the IKK complex to the plasma membrane and its subsequent activation are yet poorly understood. However, it is becoming more evident that hsp90 plays a key role in both cases. A similar role for hsp90 has been proposed for trafficking of Raf-1 to membrane-bound Ras, and the subsequent activation of Raf-1 before. Apart from hsp90, there may be other, yet unidentified, accessory proteins, either GA-sensitive or GA-tolerant (TRAF2?), taking part in shuttling of the IKK complex to TNF-R1. Moreover; once recruited, activation of the IKK complex may be dependent on an hsp90-mediated conformational stabilization and maintenance of the functionally-competent state, which is readily recognized by RIP-dependent upstream activator kinases, such as MEKK3 or MEKK1(?). These possibilities have yet to be tested by future studies.

7. CONCLUSION

The main outcomes of this study can be summarized as follows:

1) Endogenous heat shock protein 90 levels increase significantly in a time-dependent manner starting from 15 minutes of TNF treatment in HeLa cell line.

2) Endogenous heat shock protein 70 levels do not get affected in response to TNF in HeLa cell line.

3) Inhibition of hsp90 ATPase function by its specific inhibitor, geldanamycin, causes significant impairment in TNF-induced NF- κ B activation in HeLa cell line.

4) Any possible protein-protein interactions between components of TNF-induced NF- κ B signaling and hsp90 can be readily searched for based on the transfection and immunoprecipitation optimizations accomplished in this work.

Future studies will aim to search for any possible involvement of hsp90 in the cross-talk between divergent downstream pathways of TNF signaling. Understanding the exact molecular mechanisms of the interplay between TNF-mediated apoptosis, NF- κ B, JNK and Akt/PKB signaling pathways will help interpret how a specific outcome of TNF signaling is achieved in distinct biological contexts.

8. REFERENCES

1. Hahn GM, Li GC. (1982). Thermotolerance and heat shock proteins in mammalian cells. *Radiat. Res.*, **92**: 452-457.
2. Simon MM, Reikerstorfer A, Schwarz A, Krone C, Luger TA, Jaattela M, Schwarz T. (1995). Heat shock protein 70 overexpression affects the response to ultraviolet light in murine fibroblasts. Evidence for increased cell viability and suppression of cytokine release. *J.Clin. Invest.*, **95**: 926-933.
3. Jaattela M, Wissing D. (1993). Heat-shock proteins protect cells from monocyte cytotoxicity: possible mechanism of self-protection. *J. Exp. Med.*, **177**: 231-236.
4. Jaattela M, Wissing D, Bauer PA, Li GC. (1992). Major heat shock protein hsp70 protects tumor cells from tumor necrosis factor cytotoxicity. *EMBO J.*, **11**: 3507-3512.
5. Van Molle W, Wielockx B, Mahieu T, Takada M, Taniguchi T, Sekikawa K, Libert C. (2002). HSP70 protects against TNF-induced lethal inflammatory shock. *Immunity*, **16**: 685-695.
6. Hartl FU, Hayer-Hartl M. (2002). Molecular chaperones in the cytosol: from nascent chain to folded protein. *Science*, **295**: 1852-1858.
7. Neupert W. (1997). Protein import into mitochondria. *Annu. Rev. Biochem.*, **66**: 863-917.
8. Parsell DA, Lindquist S. (1993). The function of heat-shock proteins in stress tolerance: degradation and reactivation of damaged proteins. *Annu. Rev. Genet.*, **27**: 437-496.
9. Rutherford SL, Zuker CS. (1994). Protein folding and the regulation of signaling pathways. *Cell*, **79**: 1129-1132.
10. Jaattela M. (1999). Heat shock proteins as cellular lifeguards. *Ann. Med.*, **31**: 261-271.

11. Hartl FU. (1996). Molecular chaperones in cellular protein folding. *Nature*, **381**: 571-579.
12. Parsell DA, Lindquist S. (1994). *The biology of heat shock proteins and molecular chaperones*. In: Georgopoulos C (ed.). Cold Spring Harbor Press: Cold Spring Harbor, New York, pp. 457-494.
13. Lepock JR. (2003). Cellular effects of hyperthermia: relevance to the minimum dose for thermal damage. *Int. J. Hyperthermia*, **19**: 252-266.
14. Freeman BC, Morimoto RI. (1996). The human cytosolic molecular chaperones hsp90, hsp70 (hsc70) and hdj-1 have distinct roles in recognition of a non-native protein and protein refolding. *EMBO J.*, **15**: 2969-2979.
15. Bukau B, Deuerling E, Pfund C, Craig EA. (2000). Getting newly synthesized proteins into shape. *Cell*, **101**: 119-122.
16. Szabo A, Langer T, Schroder H, Flanagan J, Bukau B, Hartl FU. (1994). The ATP hydrolysis-dependent reaction cycle of the Escherichia coli Hsp70 system DnaK, DnaJ and GrpE. *Proc. Natl. Acad. Sci. USA*, **91**: 10345-10349.
17. Kiang JG, Tsokos GC. (1998). Heat shock protein 70 kDa: molecular biology, biochemistry, and physiology. *Pharmacol. Ther.*, **80**: 183-201.
18. Bukau B, Horwich AL. (1998). The Hsp70 and Hsp60 chaperone machines. *Cell*, **92**: 351-366.
19. Mosser DD, Morimoto RI. (2004). Molecular chaperones and the stress of oncogenesis. *Oncogene*, **23**: 2907-2918.
20. Nollen EA, Morimoto RI. (2002). Chaperoning signaling pathways: molecular chaperones as stress-sensing 'heat shock' proteins. *J. Cell Sci.*, **115**: 2809-2816.
21. Freeman BC, Myers MP, Schumacher R, Morimoto RI. (1995). Identification of a regulatory motif in Hsp70 that affects ATPase activity, substrate binding and interaction with HDJ-1. *EMBO J.*, **14**: 2281-2292.
22. Minami Y, Hohfeld J, Ohtsuka K, Hartl FU. (1996). Regulation of the heat-shock protein 70 reaction cycle by the mammalian DnaJ homolog, Hsp40. *J. Biol. Chem.*, **271**: 19617-19624.
23. Chen S, Smith DF. (1998). Hop as an adaptor in the heat shock protein 70 (Hsp70) and Hsp90 chaperone machinery. *J. Biol. Chem.*, **273**: 35194-35200.
24. Frydman J, Hohfeld J. (1997). Chaperones get in touch: the Hip-Hop connection. *Trends Biochem. Sci.*, **22**: 87-92.

25. Ballinger CA, Connell P, Wu Y, Hu Z, Thompson LJ, Yin LY, Patterson C. (1999). Identification of CHIP, a novel tetratricopeptide repeat-containing protein that interacts with heat shock proteins and negatively regulates chaperone functions. *Mol. Cell. Biol.*, **19**: 4535-4545.
26. Nollen EA, Kabakov AE, Brunsting JF, Kanon B, Hohfeld J, Kampinga HH. (2001). Modulation of *in vivo* HSP70 chaperone activity by Hip and Bag-1. *J. Biol. Chem.*, **276**: 4677-4682.
27. Hohfeld J, Minami Y, Hartl FU. (1995). Hip, a novel cochaperone involved in the eukaryotic Hsc70/Hsp40 reaction cycle. *Cell*, **83**: 589-598.
28. Bimston D, Song J, Winchester D, Takayama S, Reed JC, Morimoto RI. (1998). BAG-1, a negative regulator of Hsp70 chaperone activity, uncouples nucleotide hydrolysis from substrate release. *EMBO J.*, **17**: 6871-6878.
29. Hohfeld J, Jentsch S. (1997). GrpE-like regulation of the hsc70 chaperone by the anti-apoptotic protein BAG-1. *EMBO J.*, **16**: 6209-6216.
30. Nollen EA, Brunsting JF, Song J, Kampinga HH, Morimoto RI. (2000). Bag-1 functions *in vivo* as a negative regulator of Hsp70 chaperone activity. *Mol. Cell. Biol.*, **20**: 1083-1088.
31. Takayama S, Bimston DN, Matsuzawa S, Freeman BC, Aime-Sempe C, Xie Z, Morimoto RI, Reed JC. (1997). BAG-1 modulates the chaperone activity of Hsp70/Hsc70. *EMBO J.*, **16**: 4887-4896.
32. Hohfeld J, Cyr DM, Patterson C. (2001). From the cradle to the grave: molecular chaperones that may choose between folding and degradation. *EMBO Rep.*, **2**: 885-890.
33. Takayama S, Sato T, Krajewski S, Kochel K, Irie S, Millan JA, Reed JC. (1995). Cloning and functional analysis of BAG-1: a novel Bcl-2-binding protein with anti-cell death activity. *Cell*, **80**: 279-284.
34. Wang HG, Takayama S, Rapp UR, Reed JC. (1996). Bcl-2 interacting protein, BAG-1, binds to and activates the kinase Raf-1. *Proc. Natl. Acad. Sci. USA*, **93**: 7063-7068.
35. Takayama S, Reed JC. (2001). Molecular chaperone targeting and regulation by BAG family proteins. *Nat. Cell Biol.*, **3**: E237-E241.
36. Nollen EA, Brunsting JF, Roelofsen H, Weber LA, Kampinga HH. (1999). *In vivo* chaperone activity of heat shock protein 70 and thermotolerance. *Mol. Cell. Biol.*, **19**: 2069-2079.

37. Li GC, Li L, Liu RY, Rehman M, Lee WM. (1992). Heat shock protein hsp70 protects cells from thermal stress even after deletion of its ATP-binding domain. *Proc. Natl. Acad. Sci. USA*, **89**: 2036-2040.
38. Stege GJ, Li L, Kampinga HH, Konings AW, Li GC. (1994). Importance of the ATP-binding domain and nucleolar localization domain of HSP72 in the protection of nuclear proteins against heat-induced aggregation. *Exp. Cell Res.*, **214**: 279-284.
39. Mosser DD, Martin LH. (1992). Induced thermotolerance to apoptosis in a human T lymphocyte cell line. *J. Cell. Physiol.*, **151**: 561-570.
40. Mosser DD, Caron AW, Bourget L, Denis-Larose C, Massie B. (1997). Role of the human heat shock protein hsp70 in protection against stress-induced apoptosis. *Mol. Cell. Biol.*, **17**: 5317-5327.
41. Gabai VL, Meriin AB, Mosser DD, Caron AW, Rits S, Shifrin VI, Sherman MY. (1997). Hsp70 prevents activation of stress kinases. A novel pathway of cellular thermotolerance. *J. Biol. Chem.*, **272**: 18033-18037.
42. Mosser DD, Caron AW, Bourget L, Meriin AB, Sherman MY, Morimoto RI, Massie B. (2000). The chaperone function of hsp70 is required for protection against stress-induced apoptosis. *Mol. Cell. Biol.*, **20**: 7146-7159.
43. Beere HM, Green DR. (2001). Stress management – heat shock protein-70 and the regulation of apoptosis. *Trends Cell Biol.*, **11**: 6-10.
44. Buzzard KA, Giaccia AJ, Killender M, Anderson RL. (1998). Heat shock protein 72 modulates pathways of stress-induced apoptosis. *J. Biol. Chem.*, **273**: 17147-17153.
45. Jaattela M, Wissing D, Kokholm K, Kallunki T, Egeblad M. (1998). Hsp70 exerts its anti-apoptotic function downstream of caspase-3-like proteases. *EMBO J.*, **17**: 6124-6134.
46. Mao H, Li F, Ruchalski K, Mosser DD, Schwartz JH, Wang Y, Borkan SC. (2003). Hsp72 inhibits focal adhesion kinase degradation in ATP-depleted renal epithelial cells. *J. Biol. Chem.*, **278**: 18214-18220.
47. Li CY, Lee JS, Ko YG, Kim JI, Seo JS. (2000). Heat shock protein 70 inhibits apoptosis downstream of cytochrome c release and upstream of caspase-3 activation. *J. Biol. Chem.*, **275**: 25665-25671.
48. Zou H, Li Y, Liu X, Wang X. (1999). An APAF-1.cytochrome c multimeric complex is a functional apoptosome that activates procaspase-9. *J. Biol. Chem.*, **274**: 11549-11556.

49. Srinivasula SM, Ahmad M, Fernandes-Alnemri T, Alnemri ES. (1998). Autoactivation of procaspase-9 by Apaf-1-mediated oligomerization. *Mol. Cell*, **7**: 949-957.
50. Hengartner MO. (2000). The biochemistry of apoptosis. *Nature*, **407**: 770-776.
51. Adams JM. (2003). Ways of dying: multiple pathways to apoptosis. *Genes Dev.*, **17**: 2481-2495.
52. Saleh A, Srinivasula SM, Balkir L, Robbins PD, Alnemri ES. (2000). Negative regulation of the Apaf-1 apoptosome by Hsp70. *Nat. Cell Biol.*, **2**: 476-483.
53. Beere HM, Wolf BB, Cain K, Mosser DD, Mahboubi A, Kuwana T, Taylor P, Morimoto RI, Cohen GM, Green DR. (2000). Heat-shock protein 70 inhibits apoptosis by preventing recruitment of procaspase-9 to the Apaf-1 apoptosome. *Nat. Cell Biol.*, **2**: 469-475.
54. Willis S, Day CL, Hinds MG, Huang DC. (2003). The Bcl-2-regulated apoptotic pathway. *J. Cell Sci.*, **116**: 4053-4056.
55. Cheng EH, Wei MC, Weiler S, Flavell RA, Mak TW, Lindsten T, Korsmeyer SJ. (2001). BCL-2, BCL-X(L) sequester BH3 domain-only molecules preventing BAX- and BAK-mediated mitochondrial apoptosis. *Mol. Cell*, **8**: 705-711.
56. Wang X. (2001). The expanding role of mitochondria in apoptosis. *Genes Dev.*, **15**: 2922-2933.
57. Jurgensmeier JM, Xie Z, Deveraux Q, Ellerby L, Bredesen D, Reed JC. (1998). Bax directly induces release of cytochrome c from isolated mitochondria. *Proc. Natl. Acad. Sci. USA*, **95**: 4997-5002.
58. Gotoh T, Terada K, Oyadomari S, Mori M. (2004). hsp70-DnaJ chaperone pair prevents nitric oxide- and CHOP-induced apoptosis by inhibiting translocation of Bax to mitochondria. *Cell Death Differ.*, **11**: 390-402.
59. Chai J, Du C, Wu JW, Kyin S, Wang X, Shi Y. (2000). Structural and biochemical basis of apoptotic activation by Smac/DIABLO. *Nature*, **406**: 855-862.
60. Susin SA, Lorenzo HK, Zamzami N, Marzo I, Snow BE, Brothers GM, Mangion J, Jacotot E, Costantini P, Loeffler M, Larochette N, Goodlett DR, Aebersold R, Siderovski DP, Penninger JM, Kroemer G. (1999). Molecular characterization of mitochondrial apoptosis-inducing factor. *Nature*, **397**: 441-446.
61. Gurbuxani S, Schmitt E, Cande C, Parcellier A, Hammann A, Daugas E, Kouranti I, Spahr C, Pance A, Kroemer G, Garrido C. (2003). Heat shock protein 70

- binding inhibits the nuclear import of apoptosis-inducing factor. *Oncogene*, **22**: 6669-6678.
62. Ravagnan L, Gurbuxani S, Susin SA, Maise C, Daugas E, Zamzami N, Mak T, Jaattela M, Penninger JM, Garrido C, Kroemer G. (2001). Heat-shock protein 70 antagonizes apoptosis-inducing factor. *Nat. Cell Biol.*, **3**: 839-843.
 63. Arnoult D, Parone P, Martinou JC, Antonsson B, Estaquier J, Ameisen JC. (2002). Mitochondrial release of apoptosis-inducing factor occurs downstream of cytochrome c release in response to several proapoptotic stimuli. *J. Cell Biol.*, **159**: 923-929.
 64. Arnoult D, Gaume B, Karbowski M, Sharpe JC, Cecconi F, Youle RJ. (2003). Mitochondrial release of AIF and EndoG requires caspase activation downstream of Bax/Bak-mediated permeabilization. *EMBO J.*, **22**: 4385-4399.
 65. Creagh EM, Carmody RJ, Cotter TG. (2000). Heat shock protein 70 inhibits caspase-dependent and -independent apoptosis in Jurkat T cells. *Exp. Cell Res.*, **257**: 58-66.
 66. Jaattela M, Tschopp J. (2003). Caspase-independent cell death in T lymphocytes. *Nat. Immunol.*, **4**: 416-423.
 67. Cande C, Cecconi F, Dessen P, Kroemer G. (2002). Apoptosis-inducing factor (AIF): key to the conserved caspase-independent pathways of cell death? *J. Cell Sci.*, **115**: 4727-4734.
 68. Zanke BW, Boudreau K, Rubie E, Winnett E, Tibbles LA, Zon L, Kyriakis J, Liu FF, Woodgett JR. (1996). The stress-activated protein kinase pathway mediates cell death following injury induced by cis-platinum, UV irradiation or heat. *Curr. Biol.*, **6**: 606-613.
 69. Ichijo H, Nishida E, Irie K, ten Dijke P, Saitoh M, Moriguchi T, Takagi M, Matsumoto K, Miyazono K, Gotoh Y. (1997). Induction of apoptosis by ASK1, a mammalian MAPKKK that activates SAPK/JNK and p38 signaling pathways. *Science*, **275**: 90-94.
 70. Hatai T, Matsuzawa A, Inoshita S, Mochida Y, Kuroda T, Sakamaki K, Kuida K, Yonehara S, Ichijo H, Takeda K. (2000). Execution of apoptosis signal-regulating kinase 1 (ASK1)-induced apoptosis by the mitochondria-dependent caspase activation. *J. Biol. Chem.*, **275**: 26576-26581.
 71. Johnson GL, Lapadat R. (2002). Mitogen-activated protein kinase pathways mediated by ERK, JNK, and p38 protein kinases. *Science*, **298**: 1911-1912.

72. Tournier C, Hess P, Yang DD, Xu J, Turner TK, Nimnual A, Bar-Sagi D, Jones SN, Flavell RA, Davis RJ. (2000). Requirement of JNK for stress-induced activation of the cytochrome c-mediated death pathway. *Science*, **288**: 870-874.
73. Chauhan D, Li G, Hideshima T, Podar K, Mitsiades C, Mitsiades N, Munshi N, Kharbanda S, Anderson KC. (2003). JNK-dependent release of mitochondrial protein, Smac, during apoptosis in multiple myeloma (MM) cells. *J. Biol. Chem.*, **278**: 17593-17596.
74. Maundrell K, Antonsson B, Magnenat E, Camps M, Muda M, Chabert C, Gillieron C, Boschert U, Vial-Knecht E, Martinou JC, Arkininstall S. (1997). Bcl-2 undergoes phosphorylation by c-Jun N-terminal kinase/stress-activated protein kinases in the presence of the constitutively active GTP-binding protein Rac1. *J. Biol. Chem.*, **272**: 25238-25242.
75. Yamamoto K, Ichijo H, Korsmeyer SJ. (1999). Bcl-2 is phosphorylated and inactivated by an ASK1/Jun N-terminal protein kinase pathway normally activated at G2/M. *Mol. Cell. Biol.*, **19**: 8469-8478.
76. Fan M, Goodwin M, Vu T, Brantley-Finley C, Gaarde WA, Chambers TC. (2000). Vinblastine-induced phosphorylation of Bcl-2 and Bcl-XL is mediated by JNK and occurs in parallel with inactivation of the Raf-1/MEK/ERK cascade. *J. Biol. Chem.*, **275**: 29980-29985.
77. Donovan N, Becker EB, Konishi Y, Bonni A. (2002). JNK phosphorylation and activation of BAD couples the stress-activated signaling pathway to the cell death machinery. *J. Biol. Chem.*, **277**: 40944-40949.
78. Lei K, Davis RJ. (2003). JNK phosphorylation of Bim-related members of the Bcl2 family induces Bax-dependent apoptosis. *Proc. Natl. Acad. Sci. USA*, **100**: 2432-2437.
79. Noguchi K, Kitanaka C, Yamana H, Kokubu A, Mochizuki T, Kuchino Y. (1999). Regulation of c-Myc through phosphorylation at Ser-62 and Ser-71 by c-Jun N-terminal kinase. *J. Biol. Chem.*, **274**: 32580-32587.
80. Fuchs SY, Adler V, Pincus MR, Ronai Z. (1998). MEKK1/JNK signaling stabilizes and activates p53. *Proc. Natl. Acad. Sci. USA*, **95**: 10541-10546.
81. Juin P, Hueber AO, Littlewood T, Evan G. (1999). c-Myc-induced sensitization to apoptosis is mediated through cytochrome c release. *Genes Dev.*, **13**: 1367-1381.
82. Schuler M, Bossy-Wetzler E, Goldstein JC, Fitzgerald P, Green DR. (2000). p53 induces apoptosis by caspase activation through mitochondrial cytochrome c release. *J. Biol. Chem.*, **275**: 7337-7342.

83. Chipuk JE, Kuwana T, Bouchier-Hayes L, Droin NM, Newmeyer DD, Schuler M, Green DR. (2004). Direct activation of Bax by p53 mediates mitochondrial membrane permeabilization and apoptosis. *Science*, **303**: 1010-1014.
84. Palacios C, Collins MK, Perkins GR. (2001). The JNK phosphatase M3/6 is inhibited by protein-damaging stress. *Curr. Biol.*, **11**: 1439-1443.
85. Meriin AB, Yaglom JA, Gabai VL, Zon L, Ganiatsas S, Mosser DD, Zon L, Sherman MY. (1999). Protein-damaging stresses activate c-Jun N-terminal kinase via inhibition of its dephosphorylation: a novel pathway controlled by HSP72. *Mol. Cell. Biol.*, **19**: 2547-2555.
86. Park HS, Lee JS, Huh SH, Seo JS, Choi EJ. (2001). Hsp72 functions as a natural inhibitory protein of c-Jun N-terminal kinase. *EMBO J.*, **20**: 446-456.
87. Yaglom JA, Gabai VL, Meriin AB, Mosser DD, Sherman MY. (1999). The function of HSP72 in suppression of c-Jun N-terminal kinase activation can be dissociated from its role in prevention of protein damage. *J. Biol. Chem.*, **274**: 20223-20228.
88. Volloch V, Gabai VL, Rits S, Sherman MY. (1999). ATPase activity of the heat shock protein hsp72 is dispensable for its effects on dephosphorylation of stress kinase JNK and on heat-induced apoptosis. *FEBS Lett.*, **461**: 73-76.
89. Park HS, Cho SG, Kim CK, Hwang HS, Noh KT, Kim MS, Huh SH, Kim MJ, Ryoo K, Kim EK, Kang WJ, Lee JS, Seo JS, Ko YG, Kim S, Choi EJ. (2002). Heat shock protein hsp72 is a negative regulator of apoptosis signal-regulating kinase 1. *Mol. Cell. Biol.*, **22**: 7721-7730.
90. Parcellier A, Gurbuxani S, Schmitt E, Solary E, Garrido C. (2003). Heat shock proteins, cellular chaperones that modulate mitochondrial cell death pathways. *Biochem. Biophys. Res. Commun.*, **304**: 505-512.
91. Sreedhar AS, Csermely P. (2004). Heat shock proteins in the regulation of apoptosis: new strategies in tumor therapy: a comprehensive review. *Pharmacol. Ther.*, **101**: 227-257.
92. Beere HM. (2004). "The stress of dying": the role of heat shock proteins in the regulation of apoptosis. *J. Cell Sci.*, **117**: 2641-2651.
93. Chinnaiyan AM, O'Rourke K, Tewari M, Dixit VM. (1995). FADD, a novel death-domain containing protein, interacts with the death domain of Fas and initiates apoptosis. *Cell*, **81**: 505-512.
94. Juo P, Kuo CJ, Yuan J, Blenis J. (1998). Essential requirement for caspase-8/FLICE in the initiation of the Fas-induced apoptotic cascade. *Curr. Biol.*, **8**: 1001-1008.

95. Algeciras-Schimnich A, Shen L, Barnhart BC, Murmann AE, Burkhardt JK, Peter ME. (2002). Molecular ordering of the initial signaling events of CD95. *Mol. Cell. Biol.*, **22**: 207-220.
96. Li H, Zhu H, Xu CJ, Yuan J. (1998). Cleavage of BID by caspase 8 mediates the mitochondrial damage in the Fas pathway of apoptosis. *Cell*, **94**: 491-501.
97. Luo X, Budihardjo I, Zou H, Slaughter C, Wang X. (1998). Bid, a Bcl2 interacting protein, mediates cytochrome *c* release from mitochondria in response to activation of cell surface death receptors. *Cell*, **94**: 481-490.
98. Wei MC, Zong WX, Cheng EH, Lindsten T, Panoutsakopoulou V, Ross AJ, Roth KA, MacGregor GR, Thompson CB, Korsmeyer SJ. (2001). Proapoptotic BAX and BAK: a requisite gateway to mitochondrial dysfunction and death. *Science*, **292**: 727-730.
99. Desagher S, Osen-Sand A, Nichols A, Eskes R, Montessuit S, Lauper S, Maundrell K, Antonsson B, Martinou JC. (1999). Bid-induced conformational change of Bax is responsible for mitochondrial cytochrome *c* release during apoptosis. *J. Cell Biol.*, **144**: 891-901.
100. Wajant H. (2002). The Fas signaling pathway: more than a paradigm. *Science*, **296**: 1635-1636.
101. Chang HY, Nishitoh H, Yang X, Ichijo H, Baltimore D. (1998). Activation of apoptosis signal-regulating kinase 1 (ASK1) by the adapter protein Daxx. *Science*, **281**: 1860-1863.
102. Yang X, Khosravi-Far R, Chang HY, Baltimore D. (1997). Daxx, a novel Fas-binding protein that activates JNK and apoptosis. *Cell*, **89**: 1066-1076.
103. Charette SJ, Lambert H, Landry J. (2001). A kinase-independent function of Ask1 in caspase-independent cell death. *J. Biol. Chem.*, **276**: 36071-36074.
104. Gabai VL, Yaglom JA, Volloch V, Meriin AB, Force T, Koutroumanis M, Massie B, Mosser DD, Sherman MY. (2000). Hsp72-mediated suppression of c-Jun N-terminal kinase is implicated in development of tolerance to caspase-independent cell death. *Mol. Cell. Biol.*, **20**: 6826-6836.
105. Nylandsted J, Rohde M, Brand K, Bastholm L, Elling F, Jaattela M. (2000). Selective depletion of heat shock protein 70 (Hsp70) activates a tumor-specific death program that is independent of caspases and bypasses Bcl-2. *Proc. Natl. Acad. Sci. USA*, **97**: 7871-7876.
106. Liossis SN, Ding XZ, Kiang JG, Tsokos GC. (1997). Overexpression of the heat shock protein 70 enhances the TCR/CD3- and Fas/Apo-1/CD95-mediated apoptotic cell death in Jurkat T cells. *J. Immunol.*, **158**: 5668-5675.

107. Tran SE, Meinander A, Holmstrom TH, Rivero-Muller A, Heiskanen KM, Linnau EK, Courtney MJ, Mosser DD, Sistonen L, Eriksson JE. (2003). Heat stress downregulates FLIP and sensitizes cells to Fas receptor-mediated apoptosis. *Cell Death Differ.*, **10**: 1137-1147.
108. Banhart BC, Peter ME. (2003). The TNF receptor 1: A split personality complex. *Cell*, **previews**: 148-150.
109. Tang P, Hung M-C, Klostergaard J. (1996). Human pro-tumor necrosis factor is a homotrimer. *Biochemistry*, **35**: 8216-8225.
110. Grell M, Wajant H, Zimmermann G, Scheurich P. (1998). The type I receptor (CD120a) is the high-affinity receptor for soluble tumor necrosis factor. *Proc. Natl. Acad. Sci. USA*, **95**: 570-575.
111. Jiang Y, Woronicz JD, Liu W, Goeddel DV. (1999). Prevention of constitutive TNF receptor 1 signaling by silencer of death domains. *Science*, **283**: 543-546.
112. Tartaglia LA, Ayres TM, Wong GH, Goeddel DV. (1993). A novel domain within the 55 kd TNF receptor signals cell death. *Cell*, **74**: 845-853.
113. Hsu H, Xiong J, Goeddel DV. (1995). The TNF receptor 1-associated protein TRADD signals cell death and NF-kappaB activation. *Cell*, **81**: 495-504.
114. Hsu H, Shu HB, Pan MG, Goeddel DV. (1996). TRADD-TRAF2 and TRADD-FADD interactions define two distinct TNF receptor 1 signal transduction pathways. *Cell*, **84**: 299-308.
115. Hsu H, Huang J, Shu HB, Baichwal V, Goeddel DV. (1996). TNF-dependent recruitment of the protein kinase RIP to the TNF receptor-1 signaling complex. *Immunity*, **4**: 387-396.
116. Ting AT, Pimentel-Muinos FX, Seed B. (1996). RIP mediates tumor necrosis factor receptor 1 activation of NF-kappaB but not Fas/APO-1-initiated apoptosis. *EMBO J.*, **15**: 6189-6196.
117. Devin A, Lin Y, Yamaoka S, Li Z, Karin M, Liu Zg. (2001). The alpha and beta subunits of IkappaB kinase (IKK) mediate TRAF2-dependent IKK recruitment to tumor necrosis factor (TNF) receptor 1 in response to TNF. *Mol. Cell. Biol.*, **21**: 3986-3994.
118. Reinhard C, Shamon B, Shyamala V, Williams LT. (1997). Tumor necrosis factor alpha-induced activation of c-jun N-terminal kinase is mediated by TRAF2. *EMBO J.*, **16**: 1080-1092.

119. Natoli G, Costanzo A, Ianni A, Templeton DJ, Woodgett JR, Balsano C, Levrero M. (1997). Activation of SAPK/JNK by TNF receptor 1 through a noncytotoxic TRAF2-dependent pathway. *Science*, **275**: 200-203.
120. Nishitoh H, Saitoh M, Mochida Y, Takeda K, Nakano H, Rothe M, Miyazono K, Ichijo H. (1998). ASK1 is essential for JNK/SAPK activation by TRAF2. *Mol. Cell*, **2**: 389-395.
121. Xia Y, Makris C, Su B, Li E, Yang J, Nemerow GR, Karin M. (2000). MEK kinase 1 is critically required for c-Jun N-terminal kinase activation by proinflammatory stimuli and growth factor induced cell migration. *Proc. Natl. Acad. Sci. USA*, **97**: 5243-5248.
122. Chadee DN, Yuasa T, Kyriakis JM. (2002). Direct activation of mitogen-activated protein kinase kinase kinase MEKK1 by the Ste20p homologue GCK and the adaptor protein TRAF2. *Mol. Cell. Biol.*, **22**: 737-749.
123. Liu ZG, Hsu H, Goeddel DV, Karin M. (1996). Dissection of TNF receptor 1 effector functions: JNK activation is not linked to apoptosis while NF-kappaB activation prevents apoptosis. *Cell*, **87**: 565-576.
124. Song HY, Regnier CH, Kirschning CJ, Goeddel DV, Rothe M. (1997). Tumor necrosis factor (TNF)-mediated kinase cascades: bifurcation of nuclear factor-kappaB and c-jun N-terminal kinase (JNK/SAPK) pathways at TNF receptor-associated factor 2. *Proc. Natl. Acad. Sci. USA*, **94**: 9792-9796.
125. Beg AA, Baltimore D. (1996). An essential role for NF-kappaB in preventing TNF-alpha-induced cell death. *Science*, **274**: 782-784.
126. Chu ZL, McKinsey TA, Liu L, Gentry JJ, Malim MH, Ballard DW. (1997). Suppression of tumor necrosis factor-induced cell death by inhibitor of apoptosis c-IAP2 is under NF-kappaB control. *Proc. Natl. Acad. Sci. USA*, **94**: 10057-10062.
127. You M, Ku PT, Hrdlickova R, Bose HR Jr. (1997). ch-IAP1, a member of the inhibitor-of-apoptosis protein family, is a mediator of the antiapoptotic activity of the v-Rel oncoprotein. *Mol. Cell. Biol.*, **17**: 7328-7341.
128. Kreuz S, Siegmund D, Scheurich P, Wajant H. (2001). NF-kappaB inducers upregulate c-FLIP, a cycloheximide-sensitive inhibitor of death receptor signaling. *Mol. Cell. Biol.*, **21**: 3964-3973.
129. Micheau O, Lens S, Gaide O, Alevizopoulos K, Tschopp J. (2001). NF-kappaB signals induce the expression of c-FLIP. *Mol. Cell. Biol.*, **21**: 5299-5305.

130. Roy N, Deveraux QL, Takahashi R, Salvesen GS, Reed JC. (1997). The c-IAP-1 and c-IAP-2 proteins are direct inhibitors of specific caspases. *EMBO J.*, **16**: 6914-6925.
131. Yang Y, Fang S, Jensen JP, Weissman AM, Ashwell JD. (2000). Ubiquitin protein ligase activity of IAPs and their degradation in proteasomes in response to apoptotic stimuli. *Science*, **288**: 874-877.
132. Huang H, Joazeiro CA, Bonfoco E, Kamada S, Levrson JD, Hunter T. (2000). The inhibitor of apoptosis, cIAP2, functions as a ubiquitin-protein ligase and promotes *in vitro* ubiquitination of caspases-3 and -7. *J. Biol. Chem.*, **275**: 26661-26664.
133. Shu HB, Takeuchi M, Goeddel DV. (1996). The tumor necrosis factor receptor 2 signal transducers TRAF2 and c-IAP1 are components of the tumor necrosis factor receptor 1 signaling complex. *Proc. Natl. Acad. Sci. USA*, **93**: 13973-13978.
134. Verhagen AM, Ekert PG, Pakusch M, Silke J, Connolly LM, Reid GE, Moritz RL, Simpson RJ, Vaux DL. (2000). Identification of DIABLO, a mammalian protein that promotes apoptosis by binding to and antagonizing IAP proteins. *Cell*, **102**: 43-53.
135. Du C, Fang M, Li Y, Li L, Wang X. (2000). Smac, a mitochondrial protein that promotes cytochrome c-dependent caspase activation by eliminating IAP inhibition. *Cell*, **102**: 33-42.
136. Kucharczak J, Simmons MJ, Fan Y, Gelinas C. (2003). To be, or not to be: NF-kappaB is the answer--role of Rel/NF-kappaB in the regulation of apoptosis. *Oncogene*, **22**: 8961-8982.
137. Micheau O, Tschopp J. (2003). Induction of TNF receptor 1-mediated apoptosis via two sequential signaling complexes. *Cell*, **114**: 181-190.
138. Lin Y, Devin A, Rodriguez Y, Liu ZG. (1999). Cleavage of the death domain kinase RIP by caspase-8 prompts TNF-induced apoptosis. *Genes Dev.*, **13**: 2514-2526.
139. Martinon F, Holler N, Richard C, Tschopp J. (2000). Activation of a pro-apoptotic amplification loop through inhibition of NF-kappaB-dependent survival signals by caspase-mediated inactivation of RIP. *FEBS Lett.*, **468**.
140. Tang G, Yang J, Minemoto Y, Lin A. (2001). Blocking caspase-3-mediated proteolysis of IKKbeta suppresses TNF-alpha-induced apoptosis. *Mol. Cell*, **8**: 1005-1016.

141. Ravi R, Bedi A, Fuchs EJ, Bedi A. (1998). CD95 (Fas)-induced caspase-mediated proteolysis of NF-kappaB. *Cancer Res.*, **58**: 882-886.
142. Levkau B, Scatena M, Giachelli CM, Ross R, Raines EW. (1999). Apoptosis overrides survival signals through a caspase-mediated dominant-negative NF-kappaB loop. *Nat. Cell Biol.*, **1**: 227-233.
143. Wajant H, Pfizenmaier K, Scheurich P. (2003). Tumor necrosis factor signaling. *Cell Death Differ.*, **10**: 45-65.
144. Hoeflich KP, Yeh WC, Yao Z, Mak TW, Woodgett JR. (1999). Mediation of TNF receptor-associated factor effector functions by apoptosis signal-regulating kinase 1 (ASK1). *Oncogene*, **18**: 5814-5820.
145. Tournier C, Dong C, Turner TK, Jones SN, Flavell RA, Davis RJ. (2001). MKK7 is an essential component of the JNK signal transduction pathway activated by proinflammatory cytokines. *Genes Dev.*, **15**: 1419-1426.
146. Moriguchi T, Toyoshima F, Masuyama N, Hanafusa H, Gotoh Y, Nishida E. (1997). A novel SAPK/JNK kinase, MKK7, stimulated by TNFalpha and cellular stresses. *EMBO J.*, **16**: 7045-7053.
147. Chandel NS, Schumacker PT, Arch RH. (2001). Reactive oxygen species are downstream products of TRAF-mediated signal transduction. *J. Biol. Chem.*, **276**: 42728-42736.
148. Saitoh M, Nishitoh H, Fujii M, Takeda K, Tobiume K, Sawada Y, Kawabata M, Miyazono K, Ichijo H. (1998). Mammalian thioredoxin is a direct inhibitor of apoptosis signal-regulating kinase (ASK) 1. *EMBO J.*, **17**: 2596-2606.
149. Gotoh Y, Cooper JA. (1998). Reactive oxygen species- and dimerization-induced activation of apoptosis signal-regulating kinase 1 in tumor necrosis factor-alpha signal transduction. *J. Biol. Chem.*, **273**: 17477-17482.
150. Liu H, Nishitoh H, Ichijo H, Kyriakis JM. (2000). Activation of apoptosis signal-regulating kinase 1 (ASK1) by tumor necrosis factor receptor-associated factor 2 requires prior dissociation of the ASK1 inhibitor thioredoxin. *Mol. Cell. Biol.*, **20**: 2198-2208.
151. Guo YL, Baysal K, Kang B, Yang LJ, Williamson JR. (1998). Correlation between sustained c-Jun N-terminal protein kinase activation and apoptosis induced by tumor necrosis factor-alpha in rat mesangial cells. *J. Biol. Chem.*, **273**: 4027-4034.
152. Hochedlinger K, Wagner EF, Sabapathy K. (2002). Differential effects of JNK1 and JNK2 on signal specific induction of apoptosis. *Oncogene*, **21**: 2441-2445.

153. Tobiume K, Matsuzawa A, Takahashi T, Nishitoh H, Morita K, Takeda K, Minowa O, Miyazono K, Noda T, Ichijo H. (2001). ASK1 is required for sustained activations of JNK/p38 MAP kinases and apoptosis. *EMBO Rep.*, **2**: 222-228.
154. Liu H, Lo CR, Czaja MJ. (2002). NF-kappaB inhibition sensitizes hepatocytes to TNF-induced apoptosis through a sustained activation of JNK and c-Jun. *Hepatology*, **35**: 772-778.
155. Roulston A, Reinhard C, Amiri P, Williams LT. (1998). Early activation of c-Jun N-terminal kinase and p38 kinase regulate cell survival in response to tumor necrosis factor alpha. *J. Biol. Chem.*, **273**: 10232-10239.
156. Tang F, Tang G, Xiang J, Dai Q, Rosner MR, Lin A. (2002). The absence of NF-kappaB-mediated inhibition of c-Jun N-terminal kinase activation contributes to tumor necrosis factor alpha-induced apoptosis. *Mol. Cell. Biol.*, **22**: 8571-8579.
157. Tang G, Minemoto Y, Dibling B, Purcell NH, Li Z, Karin M, Lin A. (2001). Inhibition of JNK activation through NF-kappaB target genes. *Nature*, **414**: 313-317.
158. Javelaud D, Besancon F. (2001). NF-kappaB activation results in rapid inactivation of JNK in TNF alpha-treated Ewing sarcoma cells: a mechanism for the anti-apoptotic effect of NF-kappaB. *Oncogene*, **20**: 4365-4372.
159. De Smaele E, Zazzeroni F, Papa S, Nguyen DU, Jin R, Jones J, Cong R, Franzoso G. (2001). Induction of gadd45beta by NF-kappaB downregulates proapoptotic JNK signalling. *Nature*, **414**: 308-313.
160. Papa S, Zazzeroni F, Bubici C, Jayawardena S, Alvarez K, Matsuda S, Nguyen DU, Pham CG, Nelsbach AH, Melis T, De Smaele E, Tang WJ, D'Adamio L, Franzoso G. (2004). Gadd45 beta mediates the NF-kappa B suppression of JNK signalling by targeting MKK7/JNKK2. *Nat. Cell Biol.*, **6**: 146-153.
161. Harlin H, Reffey SB, Duckett CS, Lindsten T, Thompson CB. (2001). Characterization of XIAP-deficient mice. *Mol. Cell. Biol.*, **21**: 3604-3608.
162. Papa S, Zazzeroni F, Pham CG, Bubici C, Franzoso G. (2004). Linking JNK signaling to NF-kappaB: a key to survival. *J. Cell Sci.*, **117**: 5197-5208.
163. Varfolomeev EE, Ashkenazi A. (2004). Tumor necrosis factor: an apoptosis JuNKie? *Cell*, **116**: 491-497.
164. Liu J, Lin A. (2005). Role of JNK activation in apoptosis: a double-edged sword. *Cell Res.*, **15**: 36-42.

165. Deng Y, Ren X, Yang L, Lin Y, Wu X. (2003). A JNK-dependent pathway is required for TNF α -induced apoptosis. *Cell*, **115**: 61-70.
166. Gabai VL, Mabuchi K, Mosser DD, Sherman MY. (2002). Hsp72 and stress kinase c-jun N-terminal kinase regulate the bid-dependent pathway in tumor necrosis factor-induced apoptosis. *Mol. Cell. Biol.*, **22**: 3415-3424.
167. Wissing D, Mouritzen H, Egeblad M, Poirier GG, Jaattela M. (1997). Involvement of caspase-dependent activation of cytosolic phospholipase A2 in tumor necrosis factor-induced apoptosis. *Proc. Natl. Acad. Sci. USA*, **94**: 5073-5077.
168. Jaattela M. (1993). Overexpression of major heat shock protein hsp70 inhibits tumor necrosis factor-induced activation of phospholipase A2. *J. Immunol.*, **151**: 4286-4294.
169. Kolch W. (2000). Meaningful relationships: the regulation of the Ras/Raf/MEK/ERK pathway by protein interactions. *Biochem. J.*, **351**: 289-305.
170. Campbell SL, Khosravi-Far R, Rossman KL, Clark GJ, Der CJ. (1998). Increasing complexity of Ras signaling. *Oncogene*, **17**: 1395-1413.
171. Woessmann W, Meng YH, Mivechi NF. (1999). An essential role for mitogen-activated protein kinases, ERKs, in preventing heat-induced cell death. *J. Cell. Biochem.*, **74**: 648-662.
172. Yaglom J, O'Callaghan-Sunol C, Gabai V, Sherman MY. (2003). Inactivation of dual-specificity phosphatases is involved in the regulation of extracellular signal-regulated kinases by heat shock and hsp72. *Mol. Cell. Biol.*, **23**: 3813-3824.
173. Song J, Takeda M, Morimoto RI. (2001). Bag1-Hsp70 mediates a physiological stress signalling pathway that regulates Raf-1/ERK and cell growth. *Nat. Cell Biol.*, **3**: 276-282.
174. Feder JH, Rossi JM, Solomon J, Solomon N, Lindquist S. (1992). The consequences of expressing hsp70 in Drosophila cells at normal temperatures. *Genes Dev.*, **6**: 1402-1413.
175. Liu H, Vuyyuru VB, Pham CD, Yang Y, Singh B. (1999). Evidence of an interaction between Mos and Hsp70: a role of the Mos residue serine 3 in mediating Hsp70 association. *Oncogene*, **18**: 3461-3470.
176. Helmbrecht K, Zeise E, Rensing L. (2000). Chaperones in cell cycle regulation and mitogenic signal transduction: a review. *Cell Prolif.*, **33**: 341-365.

177. Young JC, Agashe VR, Siegers K, Hartl FU. (2004). Pathways of chaperone-mediated protein folding in the cytosol. *Nat. Rev. Mol. Cell Biol.*, **5**: 781-791.
178. Jakob U, Lilie H, Meyer I, Buchner J. (1995). Transient interaction of Hsp90 with early unfolding intermediates of citrate synthase. Implications for heat shock *in vivo*. *J. Biol. Chem.*, **270**: 7288-7294.
179. Nathan DF, Vos MH, Lindquist S. (1997). *In vivo* functions of the *Saccharomyces cerevisiae* Hsp90 chaperone. *Proc. Natl. Acad. Sci. USA*, **94**: 12949-12956.
180. Cheng L, Hirst K, Piper PW. (1992). Authentic temperature-regulation of a heat shock gene inserted into yeast on a high copy number vector. Influences of overexpression of HSP90 protein on high temperature growth and thermotolerance. *Biochim. Biophys. Acta.*, **1132**: 26-34.
181. Smith DF, Stensgard BA, Welch WJ, Toft DO. (1992). Assembly of progesterone receptor with heat shock proteins and receptor activation are ATP mediated events. *J. Biol. Chem.*, **267**: 1350-1356.
182. Picard D, Khursheed B, Garabedian MJ, Fortin MG, Lindquist S, Yamamoto KR. (1990). Reduced levels of hsp90 compromise steroid receptor action *in vivo*. *Nature*, **348**: 166-168.
183. Pratt WB, Toft DO. (2003). Regulation of signaling protein function and trafficking by the hsp90/hsp70-based chaperone machinery. *Exp. Biol. Med.(Maywood)*, **228**: 111-133.
184. Nathan DF, Lindquist S. (1995). Mutational analysis of Hsp90 function: interactions with a steroid receptor and a protein kinase. *Mol. Cell. Biol.*, **15**: 3917-3925.
185. Panaretou B, Prodromou C, Roe SM, O'Brien R, Ladbury JE, Piper PW, Pearl LH. (1998). ATP binding and hydrolysis are essential to the function of the Hsp90 molecular chaperone *in vivo*. *EMBO J.*, **17**: 4829-4836.
186. Obermann WM, Sonderrmann H, Russo AA, Pavletich NP, Hartl FU. (1998). *In vivo* function of Hsp90 is dependent on ATP binding and ATP hydrolysis. *J. Cell Biol.*, **143**: 901-910.
187. Grenert JP, Johnson BD, Toft DO. (1999). The importance of ATP binding and hydrolysis by hsp90 in formation and function of protein heterocomplexes. *J. Biol. Chem.*, **274**: 17525-17533.
188. Hutchison KA, Dittmar KD, Czar MJ, Pratt WB. (1994). Proof that hsp70 is required for assembly of the glucocorticoid receptor into a heterocomplex with hsp90. *J. Biol. Chem.*, **269**: 5043-5049.

189. Morishima Y, Murphy PJ, Li DP, Sanchez ER, Pratt WB. (2000). Stepwise assembly of a glucocorticoid receptor.hsp90 heterocomplex resolves two sequential ATP-dependent events involving first hsp70 and then hsp90 in opening of the steroid binding pocket. *J. Biol. Chem.*, **275**: 18054-18060.
190. Rajapandi T, Greene LE, Eisenberg E. (2000). The molecular chaperones Hsp90 and Hsc70 are both necessary and sufficient to activate hormone binding by glucocorticoid receptor. *J. Biol. Chem.*, **275**: 22597-22604.
191. Csermely P, Schnaider T, Soti C, Prohaszka Z, Nardai G. (1998). The 90-kDa molecular chaperone family: structure, function, and clinical applications. A comprehensive review. *Pharmacol. Ther.*, **79**: 129-168.
192. Prodromou C, Roe SM, O'Brien R, Ladbury JE, Piper PW, Pearl LH. (1997). Identification and structural characterization of the ATP/ADP-binding site in the Hsp90 molecular chaperone. *Cell*, **90**: 65-75.
193. Stebbins CE, Russo AA, Schneider C, Rosen N, Hartl FU, Pavletich NP. (1997). Crystal structure of an Hsp90-geldanamycin complex: targeting of a protein chaperone by an antitumor agent. *Cell*, **89**: 239-250.
194. Grenert JP, Sullivan WP, Fadden P, Haystead TA, Clark J, Mimnaugh E, Krutzsch H, Ochel HJ, Schulte TW, Sausville E, Neckers LM, Toft DO. (1997). The amino-terminal domain of heat shock protein 90 (hsp90) that binds geldanamycin is an ATP/ADP switch domain that regulates hsp90 conformation. *J. Biol. Chem.*, **272**: 23843-23850.
195. Prodromou C, Pearl LH. (2003). Structure and functional relationships of Hsp90. *Curr.Cancer Drug Targets*, **3**: 301-323.
196. Scheibel T, Siegmund HI, Jaenicke R, Ganz P, Lilie H, Buchner J. (1999). The charged region of Hsp90 modulates the function of the N-terminal domain. *Proc. Natl. Acad. Sci. USA*, **96**: 1297-1302.
197. Minami Y, Kimura Y, Kawasaki H, Suzuki K, Yahara I. (1994). The carboxy-terminal region of mammalian HSP90 is required for its dimerization and function *in vivo*. *Mol. Cell. Biol.*, **14**: 1459-1464.
198. Nemoto T, Ohara-Nemoto Y, Ota M, Takagi T, Yokoyama K. (1995). Mechanism of dimer formation of the 90-kDa heat-shock protein. *Eur. J. Biochem.*, **233**: 1-8.
199. Young JC, Obermann WM, Hartl FU. (1998). Specific binding of tetratricopeptide repeat proteins to the C-terminal 12-kDa domain of hsp90. *J. Biol. Chem.*, **273**: 18007-18010.

200. Soti C, Racz A, Csermely P. (2002). A Nucleotide-dependent molecular switch controls ATP binding at the C-terminal domain of Hsp90. N-terminal nucleotide binding unmask a C-terminal binding pocket. *J. Biol. Chem.*, **277**: 7066-7075.
201. Young JC, Schneider C, Hartl FU. (1997). *In vitro* evidence that hsp90 contains two independent chaperone sites. *FEBS Lett.*, **418**: 139-143.
202. Johnson BD, Chadli A, Felts SJ, Bouhouche I, Catelli MG, Toft DO. (2000). Hsp90 chaperone activity requires the full-length protein and interaction among its multiple domains. *J. Biol. Chem.*, **275**: 32499-32507.
203. Scheibel T, Weikl T, Buchner J. (1998). Two chaperone sites in Hsp90 differing in substrate specificity and ATP dependence. *Proc. Natl. Acad. Sci. USA*, **95**: 1495-1499.
204. Pratt WB, Toft DO. (1997). Steroid receptor interactions with heat shock protein and immunophilin chaperones. *Endocr. Rev.*, **18**: 306-360.
205. Johnson BD, Schumacher RJ, Ross ED, Toft DO. (1998). Hop modulates Hsp70/Hsp90 interactions in protein folding. *J. Biol. Chem.*, **273**: 3679-3686.
206. Prodromou C, Siligardi G, O'Brien R, Woolfson DN, Regan L, Panaretou B, Ladbury JE, Piper PW, Pearl LH. (1999). Regulation of Hsp90 ATPase activity by tetratricopeptide repeat (TPR)-domain co-chaperones. *EMBO J.*, **18**: 754-762.
207. Dittmar KD, Pratt WB. (1997). Folding of the glucocorticoid receptor by the reconstituted Hsp90-based chaperone machinery. The initial hsp90.p60.hsp70-dependent step is sufficient for creating the steroid binding conformation. *J. Biol. Chem.*, **272**: 13047-13054.
208. Hernandez MP, Sullivan WP, Toft DO. (2002). The assembly and intermolecular properties of the hsp70-Hop-hsp90 molecular chaperone complex. *J. Biol. Chem.*, **277**: 38294-38304.
209. Csermely P, Kajtar J, Hollosi M, Jalsovszky G, Holly S, Kahn CR, Gergely P Jr, Soti C, Mihaly K, Somogyi J. (1993). ATP induces a conformational change of the 90-kDa heat shock protein (hsp90). *J. Biol. Chem.*, **268**: 1901-1907.
210. Prodromou C, Panaretou B, Chohan S, Siligardi G, O'Brien R, Ladbury JE, Roe SM, Piper PW, Pearl LH. (2000). The ATPase cycle of Hsp90 drives a molecular 'clamp' via transient dimerization of the N-terminal domains. *EMBO J.*, **19**: 4383-4392.
211. Chadli A, Bouhouche I, Sullivan W, Stensgard B, McMahon N, Catelli MG, Toft DO. (2000). Dimerization and N-terminal domain proximity underlie the

- function of the molecular chaperone heat shock protein 90. *Proc. Natl. Acad. Sci. USA*, **97**: 12524-12529.
212. Johnson JL, Toft DO. (1994). A novel chaperone complex for steroid receptors involving heat shock proteins, immunophilins, and p23. *J. Biol. Chem.*, **269**: 24989-24993.
 213. Owens-Grillo JK, Czar MJ, Hutchison KA, Hoffmann K, Perdew GH, Pratt WB. (1996). A model of protein targeting mediated by immunophilins and other proteins that bind to hsp90 via tetratricopeptide repeat domains. *J. Biol. Chem.*, **271**: 13468-13475.
 214. Roe SM, Ali MM, Meyer P, Vaughan CK, Panaretou B, Piper PW, Prodromou C, Pearl LH. (2004). The mechanism of Hsp90 regulation by the protein kinase-specific cochaperone p50(cdc37). *Cell*, **116**: 87-98.
 215. Stepanova L, Leng X, Parker SB, Harper JW. (1996). Mammalian p50Cdc37 is a protein kinase-targeting subunit of Hsp90 that binds and stabilizes Cdk4. *Genes Dev.*, **10**: 1491-1502.
 216. Kimura Y, Rutherford SL, Miyata Y, Yahara I, Freeman BC, Yue L, Morimoto RI, Lindquist S. (1997). Cdc37 is a molecular chaperone with specific functions in signal transduction. *Genes Dev.*, **11**: 1775-1785.
 217. Pearl LH. (2005). Hsp90 and Cdc37 -- a chaperone cancer conspiracy. *Curr. Opin. Genet. Dev.*, **15**: 55-61.
 218. Weaver AJ, Sullivan WP, Felts SJ, Owen BA, Toft DO. (2000). Crystal structure and activity of human p23, a heat shock protein 90 co-chaperone. *J. Biol. Chem.*, **275**: 23045-23052.
 219. Dittmar KD, Demady DR, Stancato LF, Krishna P, Pratt WB. (1997). Folding of the glucocorticoid receptor by the heat shock protein (hsp) 90-based chaperone machinery. The role of p23 is to stabilize receptor.hsp90 heterocomplexes formed by hsp90.p60.hsp70. *J. Biol. Chem.*, **272**: 21213-21220.
 220. Young JC, Hartl FU. (2000). Polypeptide release by Hsp90 involves ATP hydrolysis and is enhanced by the co-chaperone p23. *EMBO J.*, **19**: 5930-5940.
 221. Panaretou B, Siligardi G, Meyer P, Maloney A, Sullivan JK, Singh S, Millson SH, Clarke PA, Naaby-Hansen S, Stein R, Cramer R, Mollapour M, Workman P, Piper PW, Pearl LH, Prodromou C. (2002). Activation of the ATPase activity of hsp90 by the stress-regulated cochaperone aha1. *Mol. Cell*, **10**: 1307-1318.
 222. Isaacs JS, Xu W, Neckers L. (2003). Heat shock protein 90 as a molecular target for cancer therapeutics. *Cancer Cell.*, **3**: 213-217.

223. Maloney A, Workman P. (2002). HSP90 as a new therapeutic target for cancer therapy: the story unfolds. *Expert Opin. Biol. Ther.*, **2**: 3-24.
224. Sreedhar AS, Soti C, Csermely P. (2004). Inhibition of Hsp90: a new strategy for inhibiting protein kinases. *Biochim. Biophys. Acta.*, **1697**: 233-242.
225. DeBoer C, Meulman PA, Wnuk RJ, Peterson DH. (1970). Geldanamycin, a new antibiotic. *J. Antibiot. (Tokyo)*, **23**: 442-447.
226. Uehara Y, Hori M, Takeuchi T, Umezawa H. (1986). Phenotypic change from transformed to normal induced by benzoquinonoid ansamycins accompanies inactivation of p60src in rat kidney cells infected with Rous sarcoma virus. *Mol. Cell. Biol.*, **6**: 2198-2206.
227. Whitesell L, Mimnaugh EG, De Costa B, Myers CE, Neckers LM. (1994). Inhibition of heat shock protein HSP90-pp60v-src heteroprotein complex formation by benzoquinone ansamycins: essential role for stress proteins in oncogenic transformation. *Proc. Natl. Acad. Sci. USA*, **91**: 8324-8328.
228. Schneider C, Sepp-Lorenzino L, Nimmegern E, Ouerfelli O, Danishefsky S, Rosen N, Hartl FU. (1996). Pharmacologic shifting of a balance between protein refolding and degradation mediated by Hsp90. *Proc. Natl. Acad. Sci. USA*, **93**: 14536-14541.
229. Tsubuki S, Saito Y, Kawashima S. (1994). Purification and characterization of an endogenous inhibitor specific to the Z-Leu-Leu-Leu-MCA degrading activity in proteasome and its identification as heat-shock protein 90. *FEBS Lett.*, **344**: 229-233.
230. Murata S, Minami Y, Minami M, Chiba T, Tanaka K. (2001). CHIP is a chaperone-dependent E3 ligase that ubiquitylates unfolded protein. *EMBO Rep.*, **2**: 1133-1138.
231. Connell P, Ballinger CA, Jiang J, Wu Y, Thompson LJ, Hohfeld J, Patterson C. (2001). The co-chaperone CHIP regulates protein triage decisions mediated by heat-shock proteins. *Nat. Cell Biol.*, **3**: 93-96.
232. Xu W, Marcu M, Yuan X, Mimnaugh E, Patterson C, Neckers L. (2002). Chaperone-dependent E3 ubiquitin ligase CHIP mediates a degradative pathway for c-ErbB2/Neu. *Proc. Natl. Acad. Sci. USA*, **99**: 12847-12852.
233. Esser C, Scheffner M, Hohfeld J. (2005). The chaperone-associated ubiquitin ligase CHIP is able to target p53 for proteasomal degradation. *J. Biol. Chem.*, **280**: 27443-27448.

234. Luders J, Demand J, Hohfeld J. (2000). The ubiquitin-related BAG-1 provides a link between the molecular chaperones Hsc70/Hsp70 and the proteasome. *J. Biol. Chem.*, **275**: 4613-4617.
235. Goetz MP, Toft DO, Ames MM, Erlichman C. (2003). The Hsp90 chaperone complex as a novel target for cancer therapy. *Ann. Oncol.*, **14**: 1169-1176.
236. Sausville EA, Tomaszewski JE, Ivy P. (2003). Clinical development of 17-allylamino, 17-demethoxygeldanamycin. *Curr.Cancer Drug Targets*, **3**: 377-383.
237. Banerji U, O'Donnell A, Scurr M, Pacey S, Stapleton S, Asad Y, Simmons L, Maloney A, Raynaud F, Campbell M, Walton M, Lakhani S, Kaye S, Workman P, Judson I. (2005). Phase I pharmacokinetic and pharmacodynamic study of 17-allylamino, 17-demethoxygeldanamycin in patients with advanced malignancies. *J. Clin. Oncol.*, **23**: 4152-4161.
238. Ramanathan RK, Trump DL, Eiseman JL, Belani CP, Agarwala SS, Zuhowski EG, Lan J, Potter DM, Ivy SP, Ramalingam S, Brufsky AM, Wong MK, Tutchko S, Egorin MJ. (2005). Phase I pharmacokinetic-pharmacodynamic study of 17-(allylamino)-17-demethoxygeldanamycin (17AAG, NSC 330507), a novel inhibitor of heat shock protein 90, in patients with refractory advanced cancers. *Clin. Cancer Res.*, **11**: 3385-3391.
239. Zhang H, Burrows F. (2004). Targeting multiple signal transduction pathways through inhibition of Hsp90. *J. Mol. Med.*, **82**: 488-499.
240. Kamal A, Thao L, Sensintaffar J, Zhang L, Boehm MF, Fritz LC, Burrows FJ. (2003). A high-affinity conformation of Hsp90 confers tumour selectivity on Hsp90 inhibitors. *Nature*, **425**: 407-410.
241. Stancato LF, Silverstein AM, Owens-Grillo JK, Chow YH, Jove R, Pratt WB. (1997). The hsp90-binding antibiotic geldanamycin decreases Raf levels and epidermal growth factor signaling without disrupting formation of signaling complexes or reducing the specific enzymatic activity of Raf kinase. *J. Biol. Chem.*, **272**: 4013-4020.
242. Schulte TW, Blagosklonny MV, Romanova L, Mushinski JF, Monia BP, Johnston JF, Nguyen P, Trepel J, Neckers LM. (1996). Destabilization of Raf-1 by geldanamycin leads to disruption of the Raf-1-MEK-mitogen-activated protein kinase signalling pathway. *Mol. Cell. Biol.*, **16**: 5839-5845.
243. Schulte TW, Blagosklonny MV, Ingui C, Neckers L. (1995). Disruption of the Raf-1-Hsp90 molecular complex results in destabilization of Raf-1 and loss of Raf-1-Ras association. *J. Biol. Chem.*, **270**: 24585-24588.

244. Grammatikakis N, Lin JH, Grammatikakis A, Tsichlis PN, Cochran BH. (1999). p50(cdc37) acting in concert with Hsp90 is required for Raf-1 function. *Mol. Cell. Biol.*, **19**: 1661-1672.
245. Cantley LC. (2002). The phosphoinositide 3-kinase pathway. *Science*, **296**: 1655-1657.
246. Datta SR, Dudek H, Tao X, Masters S, Fu H, Gotoh Y, Greenberg ME. (1997). Akt phosphorylation of BAD couples survival signals to the cell-intrinsic death machinery. *Cell*, **91**: 231-241.
247. Zha J, Harada H, Yang E, Jockel J, Korsmeyer SJ. (1996). Serine phosphorylation of death agonist BAD in response to survival factor results in binding to 14-3-3 not BCL-X(L). *Cell*, **87**: 619-628.
248. Madrid LV, Wang CY, Guttridge DC, Schottelius AJ, Baldwin AS Jr, Mayo MW. (2000). Akt suppresses apoptosis by stimulating the transactivation potential of the RelA/p65 subunit of NF-kappaB. *Mol. Cell. Biol.*, **20**: 1626-1638.
249. Kane LP, Shapiro VS, Stokoe D, Weiss A. (1999). Induction of NF-kappaB by the Akt/PKB kinase. *Curr. Biol.*, **9**: 601-604.
250. Ozes ON, Mayo LD, Gustin JA, Pfeffer SR, Pfeffer LM, Donner DB. (1999). NF-kappaB activation by TNF requires the Akt serine-threonine kinase. *Nature*, **401**: 82-85.
251. Hanna AN, Chan EY, Xu J, Stone JC, Brindley DN. (1999). A novel pathway for TNFalpha and ceramide signaling involving sequential activation of tyrosine kinase, p21(ras), and phosphatidylinositol 3-kinase. *J. Biol. Chem.*, **274**: 12722-12729.
252. Reddy SA, Huang JH, Liao WS. (2000). Phosphatidylinositol 3-kinase as a mediator of TNF-induced NF-kappaB activation. *J. Immunol.*, **164**: 1355-1363.
253. Sizemore N, Lerner N, Dombrowski N, Sakurai H, Stark GR. (2002). Distinct roles of the IkappaB kinase alpha and beta subunits in liberating nuclear factor kappa B (NF-kappaB) from IkappaB and in phosphorylating the p65 subunit of NF-kappaB. *J. Biol. Chem.*, **277**: 3863-3869.
254. Martin AG, San-Antonio B, Fresno M. (2001). Regulation of nuclear factor kappa B transactivation. Implication of phosphatidylinositol 3-kinase and protein kinase C zeta in c-Rel activation by tumor necrosis factor alpha. *J. Biol. Chem.*, **276**: 15840-15849.
255. Madrid LV, Mayo MW, Reuther JY, Baldwin AS Jr. (2001). Akt stimulates the transactivation potential of the Rel/p65 subunit NF-kappaB through utilization

of the I κ B kinase and activation of the mitogen-activated protein kinase p38. *J. Biol. Chem.*, **276**: 18934-18940.

256. Gustin JA, Ozes ON, Akca H, Pincheira R, Mayo LD, Li Q, Guzman JR, Korgaonkar CK, Donner DB. (2004). Cell type-specific expression of the I κ B kinases determines the significance of phosphatidylinositol 3-kinase/Akt signaling to NF- κ B activation **279**: 1615-1620.
257. Gustin JA, Maehama T, Dixon JE, Donner DB. (2001). The PTEN tumor suppressor protein inhibits tumor necrosis factor-induced nuclear factor kappa B activity. *J. Biol. Chem.*, **276**: 27740-27744.
258. Mayo MW, Madrid LV, Westerheide SD, Jones DR, Yuan XJ, Baldwin AS Jr, Whang YE. (2002). PTEN blocks tumor necrosis factor-induced NF- κ B-dependent transcription by inhibiting the transactivation potential of the p65 subunit. *J. Biol. Chem.*, **277**: 11116-11125.
259. Vasudevan KM, Gurumurthy S, Rangnekar VM. (2004). Suppression of PTEN expression by NF- κ B prevents apoptosis. *Mol. Cell. Biol.*, **24**: 1007-1021.
260. Leitges M, Sanz L, Martin P, Duran A, Braun U, Garcia JF, Camacho F, Diaz-Meco MT, Rennert PD, Moscat J. (2001). Targeted disruption of the zetaPKC gene results in the impairment of the NF- κ B pathway. *Mol. Cell*, **8**: 771-780.
261. Sanz L, Sanchez P, Lallena MJ, Diaz-Meco MT, Moscat J. (1999). The interaction of p62 with RIP links the atypical PKCs to NF- κ B activation. *EMBO J.*, **18**: 3044-3053.
262. Lallena MJ, Diaz-Meco MT, Bren G, Paya CV, Moscat J. (1999). Activation of I κ B kinase beta by protein kinase C isoforms. *Mol. Cell. Biol.*, **19**: 2180-2188.
263. Anrather J, Csizmadia V, Soares MP, Winkler H. (1999). Regulation of NF- κ B RelA phosphorylation and transcriptional activity by p21(ras) and protein kinase Czeta in primary endothelial cells. *J. Biol. Chem.*, **274**: 13594-13603.
264. Pastorino JG, Tafani M, Farber JL. (1999). Tumor necrosis factor induces phosphorylation and translocation of BAD through a phosphatidylinositol 3-OH kinase-dependent pathway. *J. Biol. Chem.*, **274**: 19411-19416.
265. Sato S, Fujita N, Tsuruo T. (2000). Modulation of Akt kinase activity by binding to Hsp90. *Proc. Natl. Acad. Sci. USA*, **97**: 10832-10837.

266. Basso AD, Solit DB, Chiosis G, Giri B, Tsihchlis P, Rosen N. (2002). Akt forms an intracellular complex with heat shock protein 90 (Hsp90) and Cdc37 and is destabilized by inhibitors of Hsp90 function. *J. Biol. Chem.*, **277**: 39858-39866.
267. Basso AD, Solit DB, Munster PN, Rosen N. (2002). Ansamycin antibiotics inhibit Akt activation and cyclin D expression in breast cancer cells that overexpress HER2. *Oncogene*, **21**: 1159-1166.
268. Fujita N, Sato S, Ishida A, Tsuruo T. (2002). Involvement of Hsp90 in signaling and stability of 3-phosphoinositide-dependent kinase-1. *J. Biol. Chem.*, **277**: 10346-10353.
269. Solit DB, Zheng FF, Drobnjak M, Munster PN, Higgins B, Verbel D, Heller G, Tong W, Cordon-Cardo C, Agus DB, Scher HI, Rosen N. (2002). 17-Allylamino-17-demethoxygeldanamycin induces the degradation of androgen receptor and HER-2/neu and inhibits the growth of prostate cancer xenografts. *Clin. Cancer Res.*, **8**: 986-993.
270. Xu W, Mimnaugh E, Rosser MF, Nicchitta C, Marcu M, Yarden Y, Neckers L. (2001). Sensitivity of mature ErbB2 to geldanamycin is conferred by its kinase domain and is mediated by the chaperone protein Hsp90. *J. Biol. Chem.*, **276**: 3702-3708.
271. Solit DB, Basso AD, Olshen AB, Scher HI, Rosen N. (2003). Inhibition of heat shock protein 90 function down-regulates Akt kinase and sensitizes tumors to Taxol. *Cancer Res.*, **63**: 2139-2144.
272. Nimmanapalli R, O'Bryan E, Kuhn D, Yamaguchi H, Wang HG, Bhalla KN. (2003). Regulation of 17-AAG-induced apoptosis: role of Bcl-2, Bcl-XL, and Bax downstream of 17-AAG-mediated down-regulation of Akt, Raf-1, and Src kinases. *Blood*, **102**: 269-275.
273. Zhang R, Luo D, Miao R, Bai L, Ge Q, Sessa WC, Min W. (2005). Hsp90-Akt phosphorylates ASK1 and inhibits ASK1-mediated apoptosis. *Oncogene*, **24**: 3954-3963.
274. Kim AH, Khursigara G, Sun X, Franke TF, Chao MV. (2001). Akt phosphorylates and negatively regulates apoptosis signal-regulating kinase 1. *Mol. Cell. Biol.*, **21**: 893-901.
275. Pandey P, Saleh A, Nakazawa A, Kumar S, Srinivasula SM, Kumar V, Weichselbaum R, Nalin C, Alnemri ES, Kufe D, Kharbanda S. (2000). Negative regulation of cytochrome c-mediated oligomerization of Apaf-1 and activation of procaspase-9 by heat shock protein 90. *EMBO J.*, **19**: 4310-4322.

276. Morimoto RI, Sarge KD, Abravaya K. (1992). Transcriptional regulation of heat shock genes. A paradigm for inducible genomic responses. *J. Biol. Chem.*, **267**: 21987-21990.
277. Pirkkala L, Nykanen P, Sistonen L. (2001). Roles of the heat shock transcription factors in regulation of the heat shock response and beyond. *FASEB J.*, **15**: 1118-1131.
278. Zou J, Guo Y, Guettouche T, Smith DF, Voellmy R. (1998). Repression of heat shock transcription factor HSF1 activation by HSP90 (HSP90 complex) that forms a stress-sensitive complex with HSF1. *Cell*, **94**: 471-480.
279. Morimoto RI. (1998). Regulation of the heat shock transcriptional response: cross talk between a family of heat shock factors, molecular chaperones and negative regulators. *Genes Dev.*, **12**: 3788-3896.
280. Hoang AT, Huang J, Rudra-Ganguly N, Zheng J, Powell WC, Rabindran SK, Wu C, Roy-Burman P. (2000). A novel association between the human heat shock transcription factor 1 (HSF1) and prostate adenocarcinoma. *Am. J. Pathol.*, **156**: 857-864.
281. Mathur SK, Sistonen L, Brown IR, Murphy SP, Sarge KD, Morimoto RI. (1994). Deficient induction of human hsp70 heat shock gene transcription in Y79 retinoblastoma cells despite activation of heat shock factor 1. *Proc. Natl. Acad. Sci. USA*, **91**: 8695-8699.
282. Jolly C, Michelland S, Rocchi M, Robert-Nicoud M, Vourc'h C. (1997). Analysis of the transcriptional activity of amplified genes in tumour cells by fluorescence in situ hybridization. *Hum. Genet.*, **101**: 81-87.
283. Black RA, Rauch CT, Kozlosky CJ, Peschon JJ, Slack JL, Wolfson MF, Castner BJ, Stocking KL, Reddy P, Srinivasan S, Nelson N, Boiani N, Schooley KA, Gerhart M, Davis R, Fitzner JN, Johnson RS, Paxton RJ, March CJ, Cerretti DP. (1997). A metalloproteinase disintegrin that releases tumor-necrosis-factor-alpha from cells. *Nature*, **385**: 729-733.
284. Locksley RM, Killeen N, Lenardo MJ. (2001). The TNF and TNF receptor superfamilies: integrating mammalian biology. *Cell*, **104**: 487-501.
285. Mannel DN, Echtenacher B. (2000). TNF in the inflammatory response. *Chem. Immunol.*, **74**: 141-161.
286. Karin M, Lin A. (2002). NF-kappaB at the crossroads of life and death. *Nat. Immunol.*, **3**: 221-227.
287. Chen G, Goeddel DV. (2002). TNF-R1 signaling: a beautiful pathway. *Science*, **296**: 1634-1635.

288. Li Q, Verma IM. (2002). NF-kappaB regulation in the immune system. *Nat. Rev. Immunol.*, **2**: 725-734.
289. McDermott MF, Aksentijevich I, Galon J, McDermott EM, Ogunkolade BW, Centola M, Mansfield E, Gadina M, Karenko L, Pettersson T, McCarthy J, Frucht DM, Aringer M, Torosyan Y, Teppo AM, Wilson M, Karaarslan HM, Wan Y, Todd I, Wood G, Schlimgen R, Kumarajeewa TR, Cooper SM, Vella JP, Amos CI, Mulley J, Quane KA, Molloy MG, Ranki A, Powell RJ, Hitman GA, O'Shea JJ, Kastner DL. (1999). Germline mutations in the extracellular domains of the 55 kDa TNF receptor, TNFR1, define a family of dominantly inherited autoinflammatory syndromes. *Cell*, **97**: 133-144.
290. Aggarwal BB. (2003). Signalling pathways of the TNF superfamily: a double-edged sword. *Nat. Rev. Immunol.*, **3**: 745-756.
291. Devin A, Cook A, Lin Y, Rodriguez Y, Kelliher M, Liu Z. (2000). The distinct roles of TRAF2 and RIP in IKK activation by TNF-R1: TRAF2 recruits IKK to TNF-R1 while RIP mediates IKK activation. *Immunity*, **12**: 419-429.
292. Yang J, Lin Y, Guo Z, Cheng J, Huang J, Deng L, Liao W, Chen Z, Liu Z, Su B. (2001). The essential role of MEKK3 in TNF-induced NF-kappaB activation. *Nat. Immunol.*, **2**: 620-624.
293. Kim JW, Joe CO, Choi EJ. (2001). Role of receptor-interacting protein in TNFalpha-dependent MEKK1 activation. *J. Biol. Chem.*, **276**: 27064-27070.
294. Mercurio F, Zhu H, Murray BW, Shevchenko A, Bennett BL, Li J, Young DB, Barbosa M, Mann M, Manning A, Rao A. (1997). IKK1 and IKK2: cytokine-activated IkappaB kinases essential for NF-kappaB activation. *Science*, **278**: 860-866.
295. DiDonato JA, Hayakawa M, Rothwarf DM, Zandi E, Karin M. (1997). A cytokine-responsive IkappaB kinase that activates the transcription factor NF-kappaB. *Nature*, **388**: 548-554.
296. Zandi E, Rothwarf DM, Delhase M, Hayakawa M, Karin M. (1997). The IkappaB kinase complex (IKK) contains two kinase subunits, IKKalpha and IKKbeta, necessary for IkappaB phosphorylation and NF-kappaB activation. *Cell*, **91**: 243-252.
297. Regnier CH, Song HY, Gao X, Goeddel DV, Cao Z, Rothe M. (1997). Identification and characterization of an IkappaB kinase. *Cell*, **90**: 373-383.
298. Rothwarf DM, Zandi E, Natoli G, Karin M. (1998). IKK-gamma is an essential regulatory subunit of the IkappaB kinase complex. *Nature*, **395**: 297-300.

299. Zandi E, Chen Y, Karin M. (1998). Direct phosphorylation of I κ B by IKK α and IKK β : discrimination between free and NF- κ B-bound substrate. *Science*, **281**: 1360-1363.
300. Chen ZJ, Parent L, Maniatis T. (1996). Site-specific phosphorylation of I κ B α by a novel ubiquitination-dependent protein kinase activity. *Cell*, **84**: 853-862.
301. Li ZW, Chu W, Hu Y, Delhase M, Deerinck T, Ellisman M, Johnson R, Karin M. (1999). The IKK β subunit of I κ B kinase (IKK) is essential for nuclear factor κ B activation and prevention of apoptosis. *J. Exp. Med.*, **189**: 1839-1845.
302. Verma IM, Stevenson JK, Schwarz EM, Van Antwerp D, Miyamoto S. (1995). Rel/NF- κ B/I κ B family: intimate tales of association and dissociation. *Genes Dev.*, **9**: 2723-2735.
303. Perkins ND. (2000). The Rel/NF- κ B family: friend and foe. *Trends Biochem. Sci.*, **25**: 434-440.
304. Karin M, Cao Y, Greten FR, Li ZW. (2002). NF- κ B in cancer: from innocent bystander to major culprit. *Nat. Rev. Cancer*, **2**: 301-310.
305. Wang D, Westerheide SD, Hanson JL, Baldwin AS Jr. (2000). Tumor necrosis factor α -induced phosphorylation of RelA/p65 on Ser529 is controlled by casein kinase II. *J. Biol. Chem.*, **275**: 32592-32597.
306. Zhong H, SuYang H, Erdjument-Bromage H, Tempst P, Ghosh S. (1997). The transcriptional activity of NF- κ B is regulated by the I κ B-associated PKAc subunit through a cyclic AMP-independent mechanism. *Cell*, **89**: 413-424.
307. Hoeflich KP, Luo J, Rubie EA, Tsao MS, Jin O, Woodgett JR. (2000). Requirement for glycogen synthase kinase-3 β in cell survival and NF- κ B activation. *Nature*, **406**: 86-90.
308. Beg AA, Sha WC, Bronson RT, Baltimore D. (1995). Constitutive NF- κ B activation, enhanced granulopoiesis and neonatal lethality in I κ B α -deficient mice. *Genes Dev.*, **9**: 2736-2746.
309. Lee EG, Boone DL, Chai S, Libby SL, Chien M, Lodolce JP, Ma A. (2000). Failure to regulate TNF-induced NF- κ B and cell death responses in A20-deficient mice. *Science*, **289**: 2350-2354.
310. Song HY, Rothe M, Goeddel DV. (1996). The tumor necrosis factor-inducible zinc finger protein A20 interacts with TRAF1/TRAF2 and inhibits NF- κ B activation. *Proc. Natl. Acad. Sci. USA*, **93**: 6721-6725.

311. Zhang SQ, Kovalenko A, Cantarella G, Wallach D. (2000). Recruitment of the IKK signalosome to the p55 TNF receptor: RIP and A20 bind to NEMO(IKKgamma) upon receptor stimulation. *Immunity*, **12**: 301-311.
312. Zong WX, Edelstein LC, Chen C, Bash J, Gelinas C. (1999). The prosurvival Bcl-2 homolog Bfl-1/A1 is a direct transcriptional target of NF-kappaB that blocks TNFalpha-induced apoptosis. *Genes Dev.*, **13**: 382-387.
313. Stehlik C, de Martin R, Kumabashiri I, Schmid JA, Binder BR, Lipp J. (1998). Nuclear factor (NF)-kappaB-regulated X-chromosome-linked iap gene expression protects endothelial cells from tumor necrosis factor alpha-induced apoptosis. *J. Exp. Med.*, **188**: 211-216.
314. Chen C, Edelstein LC, Gelinas C. (2000). The Rel/NF-kappaB family directly activates expression of the apoptosis inhibitor Bcl-x_L. *Mol. Cell. Biol.*, **20**: 2687-2695.
315. Guttridge DC, Albanese C, Reuther JY, Pestell RG, Baldwin AS Jr. (1999). NF-kappaB controls cell growth and differentiation through transcriptional regulation of cyclin D1. *Mol. Cell. Biol.*, **19**: 5785-5799.
316. Hinz M, Krappmann D, Eichten A, Heder A, Scheidereit C, Strauss M. (1999). NF-kappaB function in growth control: regulation of cyclin D1 expression and G0/G1-to-S-phase transition. *Mol. Cell. Biol.*, **19**: 2690-2698.
317. Bond M, Fabunmi RP, Baker AH, Newby AC. (1998). Synergistic upregulation of metalloproteinase-9 by growth factors and inflammatory cytokines: an absolute requirement for transcription factor NF-kappa B. *FEBS Lett.*, **435**: 29-34.
318. Huang S, Robinson JB, Deguzman A, Bucana CD, Fidler IJ. (2000). Blockade of nuclear factor-kappaB signaling inhibits angiogenesis and tumorigenicity of human ovarian cancer cells by suppressing expression of vascular endothelial growth factor and interleukin 8. *Cancer Res.*, **60**: 5334-5339.
319. Lewis J, Devin A, Miller A, Lin Y, Rodriguez Y, Neckers L, Liu ZG. (2000). Disruption of hsp90 function results in degradation of the death domain kinase, receptor-interacting protein (RIP), and blockage of tumor necrosis factor-induced nuclear factor-kappaB activation. *J. Biol. Chem.*, **275**: 10519-10526.
320. Chen G, Cao P, Goeddel DV. (2002). TNF-induced recruitment and activation of the IKK complex require Cdc37 and Hsp90. *Mol. Cell*, **9**: 401-410.
321. Zhou A, Scoggin S, Gaynor RB, Williams NS. (2003). Identification of NF-kappa B-regulated genes induced by TNFalpha utilizing expression profiling and RNA interference. *Oncogene*, **22**: 2054-2064.

322. Broemer M, Krappmann D, Scheidereit C. (2004). Requirement of Hsp90 activity for I κ B kinase (IKK) biosynthesis and for constitutive and inducible IKK and NF- κ B activation. *Oncogene*, **23**: 5378-5386.