

**GEOMETRICAL OPTIMIZATION OF THE BROACHING TOOLS BY
LEVELING OF THE CUTTING FORCES**



by

ARASH EBRAHIMI ARAGHIZAD

Submitted to the Graduate School of Engineering and Natural Sciences
in partial fulfillment of the requirements for the degree of
Master of Science
Sabanci University
July 2018

**GEOMETRICAL OPTIMIZATION OF THE BROACHING TOOLS BY
LEVELING OF THE CUTTING FORCES**

APPROVED BY:

Prof. Dr.Erhan BUDAK
(Thesis Supervisor)

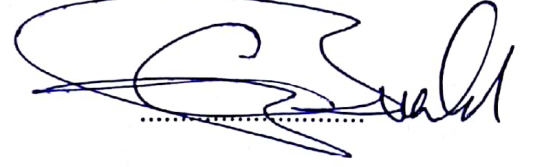

Dr.Emre OZLU
(Thesis Co-Advisor)

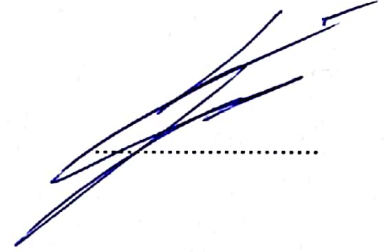

Asst. Prof. Dr. Eralp DEMIR



Asst. Prof. Dr. Lutfi Taner TUNC



Asst. Prof. Dr. Umut KARAGUZEL



DATE OF APPROVAL: 31/07/2018



© Arash EBRAHIMI ARAGHIZAD 2018

All Rights Reserved



to my family

GEOMETRICAL OPTIMIZATION OF THE BROACHING TOOLS BY LEVELING OF THE CUTTING FORCES

Arash EBRAHIMI ARAGHIZAD

Manufacturing Engineering, MSc, 2018

Thesis Supervisor: Prof. Dr. Erhan BUDAK

Keywords: Machining, Broaching, Broach tooth design optimization, Cutting force

ABSTRACT

Subtractive machining has been one of the most extensively used manufacturing methods since the industrial revolution and the broaching operation is one of the ideal and oldest machining processes for accomplishing various applications such as turbine disc fir-tree slots, non-circular internal holes and keyways. Since the broaching operation accomplished by the linear cutting motion. Although broaching process is the only machining operation in order to machine complicated profiles without using a rotary motion, it is one of the least studied one in the literature.

Due to nature of the broaching process, the broach tool design is the most important step during this operation since except cutting speed there is no any other flexibility. Therefore, modeling of the cutting process and predicting critical parameters before the design stage is crucial for optimum tool design. In previous studies, an optimized model without considering constant cutting forces for broaching tool design was presented. However, developing a method to generate an optimized broach tool design based on constant cutting forces can eliminate potential problems (i.e. reduced tool life and chipping, tooth breakage, poor surface quality etc.) while decreasing its length.

In this study, a method is developed in order to minimize the length of the broach, increase tool life and quality of the final part leading to reduction of whole process cost by leveling of the cutting forces in each broaching process cycle, i.e. roughing, semi-finishing and finishing.

KESME KUVVETLERİNİN SEVİYESİNİ AYARLAYARAK BROŞ TAKIMLARININ GEOMETRİK OPTİMİZASYONU

Arash EBRAHİMİ ARAGHIZAD

Üretim Mühendisliği, Yüksek Lisans Tezi, 2018

Tez Danışmanı: Prof. Dr. Erhan BUDAK

Anhatar Kelimeler: Talaşlı imalat, broşlama, broş diş tasarımı ve optimizasyonu, kesme kuvveti

Özet

Talaşlı imalat, endüstri devriminden beri son derece eski ve yaygın olarak kullanılan bir imalat metodudur. Broşlama operasyonu da takım tezgahlarında kullanılan en eski yöntemlerden olup, pek çok uygulama için kullanılmaktadır. Örneğin, yuvarlak profile sahip olmayan deliklerin delinmesinde ve türbin disklerine çam ağacı (fir-tree) formunda yiv ve kama yuvalarının açılmasında kullanılır. Broşlama prosesi iş parçasından düz çizgisel hareketle talaş kaldırmaktadır. Broşlama talaşlı imalat operasyonları içerisinde üzerinde en az çalışılan alanlardan biridir.

Broşlama prosesinin doğası gereği, takım üretildikten sonra proses planında yalnızca kesme hızı değiştirilebilir. Bu sebeple, broş takımı tasarımı tüm broşlama operasyonunun en önemli aşamasıdır. Bu yüzden takımın üretiminden önce, kesme prosesinin modellenmesi ve kritik parametrelerin tahmini optimum takım dizaynı elde edebilmek kritik bir önem taşır. Geçmiş çalışmalarda, kesme kuvvetleri sabit tutulmadan optimizasyon çalışması yapılmıştır. Fakat, sabit kesme kuvvetleri altında gerçekleşen bir broş operasyonu karşılaşılabilecek problemleri elimine edebilir. Bu sayede takım ömründe azalma, kesici ucun körelmesi, diş kırılması, kötü yüzey kalitesi gibi problemler çözülebilir ve aynı zamanda takımın boyu/işlem zamanı kısaltılabilir.

Bu çalışmada amaç, yukarıda bahsedilen sabit kuvvet ile gerçekleştirilebilen bir broşlama operasyonu için takım tasarımı yapılmasıdır. Bu sayede, takım boyu minimize edilebilecek, takım ömrünü uzayacak ve parçanın kalitesi iyileşecektir. Ayrıca bu çözüm prosesin toplam maliyetini düşürmektedir.

TABLE OF CONTENTS

ABSTRACT	i
Özet	ii
TABLE OF CONTENTS	iii
FIGURES	v
TABLES	viii
Chapter 1. INTRODUCTION	1
1.1 Literature Survey.....	4
1.2 Problem Definition.....	12
1.3 Research Motivation	15
1.4 Layout of Thesis.....	16
Chapter 2. BROACHING PROCESS MODELING	18
2.1 Mechanics of Orthogonal Cutting	18
2.2 Mechanics of Oblique Cutting	23
2.2.1 Prediction of Shear Angle (Oblique cutting)	25
2.2.1.1 Maximum shear stress principle.....	25
2.2.1.2 Minimum energy principle	26
2.2.1.3 Empirical approach for shear angle prediction	27
2.3 Prediction of cutting forces in oblique cutting.....	28
2.4 Broaching tool geometry.....	29
2.4.1 Total broach length.....	32
2.4.2 Pitch length.....	33
2.4.3 Rake angle	33
2.4.4 Clearance angle	33
2.4.5 Rise per tooth.....	34
2.5 Broaching mechanics	34
Chapter 3. INTERMEDIATE TEETH GENERATION	37
3.1 Inputs needed for intermediate teeth generation model.....	37
3.2 Intermediate teeth generation methods	40

3.2.1	Finishing intermediate teeth generation	41
3.2.1.1	Offsetting algorithm	43
3.2.2	Roughing intermediate teeth generation.....	44
3.2.2.1	Leveling of cutting forces	48
3.2.3	Semi-finishing intermediate teeth generation.....	50
Chapter 4.	SIMULATION AND DISCUSSION	54
4.1	Analysis on cutting forces.....	54
4.2	Analysis on rake and inclination angles.....	61
4.3	Analysis on the approach angle at the semi-finishing step	65
4.4	Cutting forces at the intersection of regions	68
Chapter 5.	CONCLUSIONS.....	69
5.1	Original contributions	71
5.1.1	Comparison between real and simulated broaching tool.....	71
5.2	Recommendation for future research.....	74
REFERENCES	76

FIGURES

Figure 1-1 Basic broaching process view.	3
Figure 1-2 Broaching teeth profile.	3
Figure 1-3. Schematic diagram of the monitoring system [7].	7
Figure 1-4. Cutting parameters in turning, milling and broaching[23].	13
Figure 1-5 Variable cutting forces applied on broaching teeth [24].	14
Figure 1-6 Constant cutting forces in roughing and semi-finishing step.	14
Figure 1-7. (a) Fir-tree slots on turbine disk (b) Turbine disk joints with blades.	15
Figure 2-1 Orthogonal cutting geometry [25].	19
Figure 2-2 Three deformation zone in orthogonal cutting [25].	19
Figure 2-3 Cutting force diagram [25].	20
Figure 2-4 Cutting force components.	21
Figure 2-5 Oblique cutting geometry [25].	23
Figure 2-6 Geometry of oblique cutting [25].	24
Figure 2-7 Solution procedure of shear angle [25].	25
Figure 2-8 Cutting edges for: a) End mill tool. b) Indexable end mill. c) Face mill. d) Turning tool.	30
Figure 2-9 Front profiles in some broaches.	31
Figure 2-10 Side view of typical broach.	32
Figure 2-11 Cutting angles: a) 3D view b) Side view c) Top view.	32
Figure 2-12 Cutting Forces directions.	36
Figure 3-1 Last tooth shape.	38
Figure 3-2 Uncut chip thickness at finishing step.	39
Figure 3-3 Approach angle at semi-finishing step.	39

Figure 3-4 Various steps of the broaching process: Roughing, semi-finishing and finishing.....	41
Figure 3-5 Finishing teeth of fir-tree broach.	42
Figure 3-6 Invalid loops in offsetting[38].	43
Figure 3-7 Boundary points on generated finishing curve.	44
Figure 3-8 Boundary points on generated finishing curve with generated roughing teeth.	45
Figure 3-9 Local rake and inclination angle of broaching tools.	46
Figure 3-10 First teeth dimensions and uncut chip thickness at roughing step.	48
Figure 3-11 Simulation algorithm for generating the intermediate roughing teeth.	50
Figure 3-12 Approach angle at semi-finishing step.	51
Figure 3-13 First semi-finishing teeth and cutting edges.	51
Figure 3-14 Simulation algorithm for generating the semi-finishing intermediate teeth	53
Figure 4-1 Broaching teeth simulation: Limiting cutting force in roughing and semi-finishing is 20,000 N, rake and inclination angles are set to zero, approach angle is selected as 15°	55
Figure 4-2 Tangential cutting forces acting on each tooth.	55
Figure 4-3 Broaching teeth simulation: Limiting cutting force in roughing and semi-finishing is selected as 10,000 N, rake and inclination angle is set to zero, approach angle is 15°	56
Figure 4-4 Tangential cutting forces acting on each tooth.	57
Figure 4-5 Broaching teeth simulation: Limiting cutting force in roughing and semi-finishing is selected as 2,000 N, rake and inclination angle is set to zero, approach angle is selected as 15°	58
Figure 4-6 Tangential cutting forces acting on each tooth.	58
Figure 4-7 Roughing cutting force is 5,000 N and semi-finishing cutting force is 2,000 N.	59
Figure 4-8 Tangential cutting forces acting on each tooth.	60
Figure 4-9 Cutting force vs Teeth number.	60

Figure 4-10 Rake and inclination angle is set to zero a)teeth shape b)tangential cutting force on each tooth.	61
Figure 4-11 Rake angle is 15° and inclination angle is set to zero a)teeth shape b)cutting force on each tooth.	61
Figure 4-12 Rake angle is 30° and inclination angle is set to zero a)teeth shape b)tangential cutting force on each tooth.	62
Figure 4-13 Rake angle vs Teeth number.	62
Figure 4-14 Inclination angle is 15° and Rake angle is zero: a)teeth shape b)tangential cutting force on each tooth.	63
Figure 4-15 Inclination angle is 30° and Rake angle is zero: a)teeth shape b)tangential cutting force on each tooth.	64
Figure 4-16 Inclination angle vs Teeth number.	64
Figure 4-17 approach angle is 5°: a) teeth shape b) tangential cutting force on each tooth.	65
Figure 4-18 Approach angle is 15°: a) teeth shape b) tangential cutting force on each tooth.	66
Figure 4-19 Approach angle is 30°: a) teeth shape b) tangential cutting force on each tooth.	66
Figure 4-20 Approach angle vs Semi-finishing teeth number.	67

TABLES

Table 3-1: Orthogonal database for Ti₆Al₄V alloy.....47



Chapter 1. INTRODUCTION

Techniques of machining, involved in manufacturing parallel with other technologies, e.g. material sciences, automation control and computers, have advanced in the last years. Nowadays prompt development of industries increases the requirement to produce advanced parts and machines with various levels of complexity and sensitivity in order to satisfy the market demands. Despite the unprecedented escalation in novel manufacturing technologies, e.g. additive manufacturing and hybrid manufacturing, machining techniques hold the center of interest of automation, aerospace and mold industry in manufacturing of desired parts. Productivity, broad applications, accuracy and efficiency of machining technologies identify them as preferred manufacturing techniques compared with others. Machining can be used to manufacture various material types including metals, polymers, composite materials, cast irons, ceramics, woods, rocks etc. metal cutting is one of the most common and oldest machining methods among others. Moreover, metal cutting includes several methods such as broaching, turning, milling, boring, drilling etc. However, various types of metal cutting has been done with their own machining tools such as broaching machines, lathe, milling machine, drill etc. also these processes has been operated with different cutting tools.

Yet, one of the biggest challenges for producers is manufacturing of accurate parts in the shortest possible time with combination of several components running together in order to maximize productivity. Power transmitting components, motion drivers and controllers, structural components and finally cutting tool holders and tools are all in cooperation with each other to achieve a final goal, which is producing parts and products

with satisfactory quality and accuracy at desired production rate and cost. One of the most critical elements in the machining operation is the cutting tool, which is frontier of cutting action. Therefore, design, optimization, and reduction of the direct manufacturing costs associated with cutting tools and machining operations are never-ending issues in manufacturing industry.

Most common metal cutting processes is multi-teeth cutting operations in which more than one cutting edge is engaged with the workpiece simultaneously in order to removing material from surface of raw material. Sawing, milling, parallel turning and broaching are the most common instances of multi-teeth cutting operations.

Broaching process is conducted by pushing or pulling linear multi-teeth broach tool including several details over the stock material to achieve high productivity, quality, and geometric complexities. Broaching tools are made up of various segments (details) and hundreds of cutting teeth, each include different profile to do desired machining. Broaches are shaped similar to a saw, except the height of the teeth increases over the length of the tool.

Each tooth in broaching operation designed specifically for desired sections of broaching tool in order to do roughing, semi-finishing or finishing operations. Broach tool is a collection of single-point cutting tools , which arrayed in sequence. Broaches are shaped similar to a saw, except the height of the teeth increases over the length of the tool. Each tooth in various sections of broach tools is different from previous one. Some of those are only different in size with the same shape and some of them are slightly different in shape. Moreover, the shape of the broach is always the inverse of the profile of the machined surface. (Figure 1-1 and Figure 1-2).

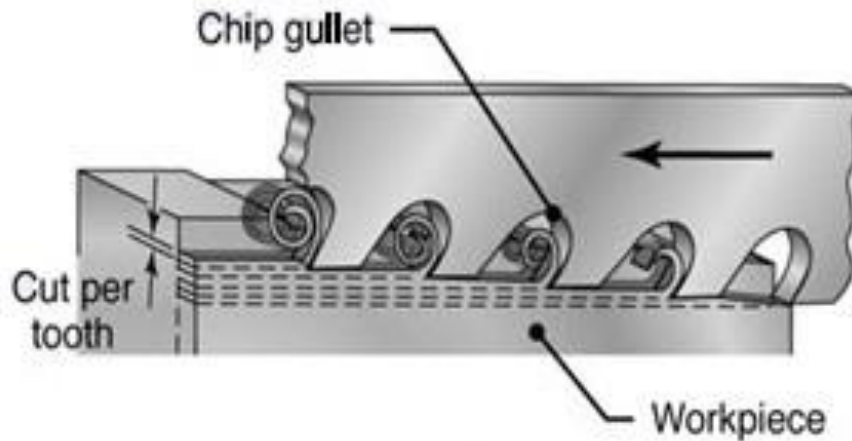

Figure 1-1 Basic broaching process view.

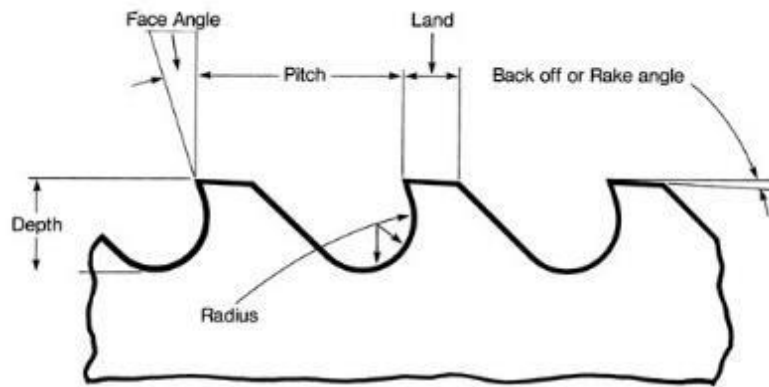

Figure 1-2 Broaching teeth profile.

Broaching has considerable advantages in comparison to the other machining processes when applied properly. Roughing, semi finishing and finishing process of broaching operation of complex desired profiles can be accomplished by one stroke of the broach whereas many passes would be needed in other conventional machining applications such as milling and turning. Machining the whole product with only linear motion in one stroke is one of the most significant differences between broaching and other machining processes, which results very good surface finish.

One of the considerable differences between broaching and other cutting operation is, in this process except cutting speed all process parameters are built into broach tool. Therefore, there is no chance to change or optimize process parameters after cutting tools

are manufactured. This makes tool design the most critical aspect of broaching. The tool design optimization includes the strategy of cutting and decision of rise per tooth as a part of geometrical optimization of tool design. Furthermore, maximum allowable force on a single cutting tooth and the total forces, which applied on the broach, must be considered during the tool design step. Thus, all of these parameters have high impact on the number of teeth and total length of broaching tool. Consequently, tool design process of broaching tools is complex and it affects costs of the broaching tools and productivity directly.

Variable cutting forces are source of various problems during broaching operation such as chipped and broken tooth, which reduced tool life. The other problem that caused by variable cutting force is poor surface quality. Therefore, developing an optimized method of designing broach tool to avoid mentioned problems by leveling of cutting forces during this process is the main motivation of this study.

This study presents an algorithm for designing of broach tool for any given arbitrary free slots with the aim of maximum constant cutting forces, which can be applied in various cycles of broaching, process. The method utilize maximum rise per tooth allowed by the given constraints such as cutting forces in each region. Therefore, the number of teeth in each cycle of desired shape is minimized. Given above information, it is essential to have a comprehensive perspective over the geometrical optimization of broaching tools in order to ensure well-designed tools by appropriate selection of constraints and geometry parameters.

1.1 Literature Survey

Machining is one of various processes in which a work piece or raw material is cut into a desired part with a controlled material-removal process. The most common applications in machining are turning, milling and drilling. There are also special applications such as broaching, boring, hobbing, shaping, and grinding. Although broaching has been one the most extensively used of machining operations in order to manufacturing of various products in the past, in the most of applications it has been replaced by milling because of developments in CNC machine tools, higher speed, precision and most importantly

flexibility of milling. This may be one of the reasons for very limited work published on broaching process.

Monday [1] presented the most comprehensive source describing the broaching technology. In the book, which is one of the earliest works on broaching application, broaching machines, processes and tools has been described in a detailed manner. Although this book was published in 1960, most of the material in the book still applies to current broaching operations. In later works the effect of the broaching operation in industries were investigated. The effectiveness of the process in different broaching applications in industry is demonstrated by collection of the works edited by Kokmeyer [2]. One of the comprehensive works about broaching is accomplished by Bangalore. Bangalore [3] presented an extensive work about broaching operation such as broaching process, broaching machines, broaching techniques and type of broaches, broach design and re-sharpening of broaching tools in this study. As demonstrated before one of the significant steps in broaching operation is tool design because of various constraints which couldn't be changed during operation. In order to design broaching tools Hamm et al.[4] present a trial and error method. Trial and error method couldn't be a good approach for tool design in broaching operations. Such an approach can result in expensive tooling cost, poor quality because of inability to control tolerances, and lost revenues due to low production rate. Therefore, there was a need for designing broaching tools with predicting cutting parameters. Terry et al.[5] worked on design parameters and parameters that related to the broaching operation. This work describes a computer aided design process, which can be simultaneously solved for: 1) The optimizing design of broaching tool parameters, and 2) The optimization of the broaching process operating parameters. In this study, three types of objectives are used in order to design manufacturing systems. The first objective of optimization is minimizing unit price. This minimization of price is appropriate for contracts, which has fixed price. The second objective is maximizing production rate and this case is appropriate for situations when the part producer is sole source supplier with a cost plus contract. The final objective, maximizing profitability, is applicable when the price of final part is related to the amount of production. In addition, they presented the factors that affect productivity in broaching and explained the design constraints, their importance, and their selection method.

In later works, similar to the other operations cutting forces are studied in broaching tools. One the first studies about broaching operation cutting forces is accomplished by Gilormini. Gilormini et al.[6] analyzed the comparison of cutting forces on a single broaching, slotting and tapping processes. In this study, the following three main conclusions were achieved:

- a) A new method has been proposed to derive physically significant quantities from broaching, tapping and slotting tests;
- b) The specific chip evacuation force has been related to the dry friction coefficient measured with plane strain compression tests;
- c) The specific chip formation force of the different materials has been compared and the rigidity of the tool-workpiece system plays a significant role, as well as the quality of the lubricant, the Sulphur content or microstructure of the machined material, and the thermal conditions in the tool.

Process monitoring is one of the most important studies of all machining processes in order to monitor cutting forces and analyzing the results to find the source of potential problems. In the later works, process monitoring in broaching was studied, as well. The performance of broaching tools used for broaching of waspaloy turbine discs with fir-tree profile based on the monitoring of force and power is presented by Budak [7]. In this study, monitoring and analysis of forces and power in broaching process is performed in order to improve tool design and part quality, and eliminate tooling problems such as excessive wear and tooth breakage. To achieve this, force measurement systems were installed on broaching machines to monitor tool wear, detect breakage and assess tool design. Piezo-electric force sensors were used and preloaded under the base block beneath the indexer unit on which the part is clamped. Power monitoring provided useful information about distribution of cutting forces on tool's teeth and among various broaching sections. As a conclusion Budak [7] demonstrated that for most of the investigated tools, the load distribution among the broaching sections were non-uniform resulting in excessive wear, overloaded sections, breakage, unnecessarily long cycle times and tool length, and part deformation. In the other study of broaching tool condition monitoring Axinte et al.[8] reports on research which attempts to find correlation between

the condition of broaching tools and the output signals that obtained from multiple sensors, namely, acoustic emission (AE), vibration, cutting forces and hydraulic pressure, connected to a hydraulic broaching machine. The main aim of the work was identifying proper techniques for tool condition monitoring during broaching and utilizing sensory signals. The tool condition monitoring system and its main characteristics are shown in Figure 1-3.

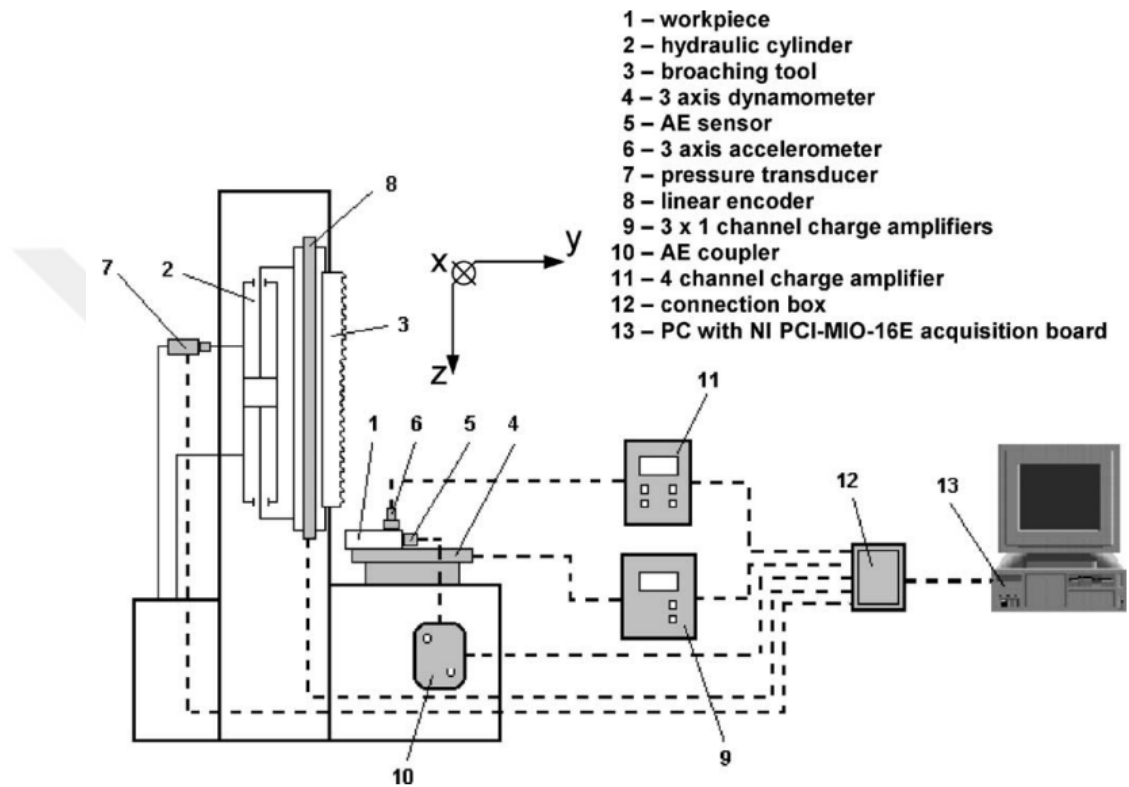

Figure 1-3. Schematic diagram of the monitoring system [7].

The results of this work show that acoustic emission, cutting force and vibration signals are all related to broach conditions and a correlation can be made between the broaching tool conditions and sensory signals by using a variety of signal analysis techniques. In addition, a brief review of the advantages and the disadvantages of each sensor/signal and its associated analysis technique is presented. It is concluded that the most sensitive sensors to use in tool condition are not inevitably those that are simple to mount or incorporate in a broaching machine. This can constrain restrictions on the types of sensors that can be added to machines. In addition, Axinte et al.[9] presents a new methodology to detect and locate some surface anomalies generated on Ti-6-4 alloy by abusive dovetail

broaching. The recognition and determination of critical surface anomalies such as smearing of parent material, directed scoring and surface overheating have been done by defining characteristic frequency features and threshold values, the time and frequency domain analysis of AE and force signals. Parallel surface integrity analysis has been used for calibration and validation of this methodology, characterization and locating the anomalies relative to the workpiece reference system. This approach demonstrates that, it is possible to construct process-monitoring tools to assess surface quality of aero-engine components in broaching application.

Process modeling is one of the significant steps for prediction of cutting forces and other machining parameters. Various method has been used for modeling of machining processes such as finite element method or analytical and semi-analytical modeling. There are a few studies, which focus on broaching process modeling. Vijayaraghavan et al. [10] in their work highlighted the stress and displacement in broach tools during operation using the Finite Element Method (FEM). Similar studies (stress and displacement based on FEM) on workpiece are also highlighted in their study. In the first step, two different rake angle (0° & 10°) was used in order to measure of tensile stresses. Displacement of broach tool in these two different rake angle was mentioned in this study as well. In the second step, the principal stresses and deformation pattern at the inner wall of the workpiece were investigated. This shows that the material in the zone (up to a depth of 250-500 μm from the inner surface) is work-hardened, which affect the performance of the broached surface during operation. Therefore, it is possible to evaluate the depth of the work hardened zone using FEM technique. Thus, this method can be used in order to evaluating surface integrity in broaching. In addition, Sajeev et al.[11] used FEM to analyzing the stresses and deflections of the broach and workpiece while cutting and burnishing. In the burnishing section of this study, the stresses result yielding on the workpiece, and therefore, non-linear material behavior is considered for the workpiece. The program, which was developed by Sajeev et al. [11], further modified to compute residual stresses on the broached component, as well and as a result, near the inner surface, the residual stresses are very high and it drops to low values when the diameter increases.

Sutherland et al.[12] developed a mechanistic model for the cutting forces in broaching. The part considered in this study, is internal helical ring gear. The model is based on relationship between the chip load and the three-dimensional cutting force system. Mechanistic model in this study contains two section as below:

- a) The tool-work contact area (chip load). This part of model should describe the chip load as a function of tool, work and process geometry.
- b) The chip load-cutting force relationship. This section describes how the cutting forces change as a function of the chip load. Typically, this model is empirical.

After modeling of each process optimization of modeled process is the next step. Due to the nature of broaching process optimization in this process is focused on tool design optimization. Since except cutting forces other important machining parameters such as feed rate and depth of cut are embedded in tool design. Therefore, in broaching operation optimization of tool design is the most critical step of broaching operation. Various optimizations has been done with considering various objective functions. Minimizing force fluctuation, the length of the broach tool, the number of teeth, optimizing geometrical features and maximizing material removal rate are some of the objectives for broach tool design optimization. Ozturk et al.[13] presented tool optimization method and broaching process models. In this work, tooth stresses, cutting forces and part deflections were modeled. Turbine disc fir tree slots, which is one of the most complex shapes for broaching operation is considered as the application in this work. This model can be used for other broaching applications because they summarized the analysis in analytical forms. Optimization, which was obtained in this study, minimized force fluctuation to eliminate accelerated tool wear and quality problems. In addition, Ozturk et al.[13] developed a simulation system for predicting power, cutting forces, stresses on teeth and part deflection. In contemplation of tool design methods, Kopturk et al.[14] developed an optimum tool design which is the shortest possible broach tool by respecting various constraints such as physical or geometrical constraints.

Hosseini has done several works in broaching process such as B-spline interpolation of cutting edge, prediction of cutting forces, parametric simulation of tool and workpiece interaction in broaching tool and optimized design of broaching tool. As a first work,

Hosseini et al.[15] presented B-spline interpolation of cutting edge to generate a general force model for orthogonal broaching. By taking geometric flexibility of B-spline curves, their model was capable of modeling any arbitrary orthogonal broaching cutting edge geometry as well as computing the chip load for various cutting conditions. There is no limitation to interpolate cutting edge of broaching tool in the presented model. As a first step, each cutting edge is modeled by B-spline parametric curves; then the integration of area between the two successive edges computed and as a result, the chip load is calculated. The general modeling approach in these studies is semi-analytical, however some studies use numerical methods as well. Cutting force prediction was studied by Hosseini et al[16]. In this study, a force model is developed by using B-spline representation of the cutting edge to define the cutting forces in orthogonal and oblique broaching. The model, which presented in this work, interpolate cutting edge of broaching tool without any limitations. The simulated cutting forces was used to optimize the geometric features of broaching tool by Hosseini et al [17]. This study presents a geometric and predictive force model for the broaching tools and operations. The broaching tooth is considered as a cantilevered beam and energy consumption is the base of predicting cutting forces. In order to tool geometry design mathematical optimization is used in which maximum material removal rate (MRR) is considered as an objective function and other geometric features of a broaching tool such as pitch length, rake angle, clearance angle, and feed rate have been determined accordingly to satisfy the objective function. In the other work analytical simulation of tool and workpiece engagement in broaching process was developed by Hosseini et al[18].

The approach of non-linear optimization presented by Ozelkan et al. [19] The pitch and the tooth rise are subjected to the multi-start complex method in order to obtain the optimum values. In this study, they provided a mathematical programming formulation for the broaching design problem. The problem yields a non-linear and non-convex optimization problem. They decomposed the problem in order to solve it. To solve decomposed problems graphical approach or multi-start non-linear optimization algorithm is used.

Some experimental studies has been done in order to determining suitable cutting parameters, surface roughness and stable machining. Selection of suitable cutting

condition by means of stable cutting and surface quality are the subject of some experimental studies. Mo et al.[20] describes a multi-step methodology to select the cutting conditions for machining of Ni and Ti alloys used in aero-engines and power generators with broaching application. The cutting parameters such as rake angle, coolant type, feed rate and cutting speed were considered to obtain best surface quality with reasonably low levels of main cutting forces and perpendicular cutting force. All selection of cutting parameters based on application of Taguchi technique. In this study in order to characterize the worn tools, Scanning electron microscopy (SEM) and chemical composition analysis on the rake and flank faces of the tools were applied and the following aspects of the broaching process were highlighted:

- a) Optimization of cutting parameters are even more demanding when critical components such as gas turbine engines parts, are manufactured in difficult-to-cut materials.
- b) For selection of cutting parameters, at the first step, variation intervals of process parameters could be identified by statistical analysis of the output measures, and for the second step, the “pseudo-optimal” values of cutting conditions are specified by tool life tests, process productivity, tool stiffness and machine tool stability.
- c) Broaching forces and tool smearing can limit tool usage even though tool wear may not reach the critical value.

The dynamics of each processes is the most critical subjects to determine stable situations for machining of various workpiece. Chatter in broaching are highly dependent on the cut profiles (open/closed geometries, external/internal) and process particularities such as: broaching properties (number of cutting teeth simultaneously in contact with the raw material, cutting zone of each tooth), tool design and dynamics of the setup. There are a few works which are related to the broaching operation dynamics. For instance, Axinte et al.[21] reports aspects related to dynamics of broaching. This work describes an experimental analysis of causes and outcomes of damped-coupled vibrations when broaching semi-closed profiles such as dovetails of gas turbine engines disks. Signals analysis of force and acceleration declare that damped-coupled vibrations which is result in tilted chatter marks mainly occur due to specific geometry of cutting edges. In order to

detect the appearance of tilted marks, which is a result of damped-coupled vibrations a new method has been generated by monitoring the elliptical movement of cutting edge via time and frequency domain analysis of two acceleration signals.

Automatic tool design or teeth generation is one of the latest works. Various constraints are used in order to accomplishing generation of the intermediate teeth at roughing, semi-finishing and finishing step of broaching operation. Recently, Vogtel et al.[22] present automatic broaching tool design by geometrical optimization. The tool design includes the cutting strategy and the determination of the rise per tooth as a part of the tool geometry. The constraints, which considered in this work, are the maximal allowable load on a single cutting edge or the total load on the tool. This paper presents an algorithm for automatic broach tool design for any given slot profile. The aim of this algorithm is optimal cutting force distribution and thereby to increase efficiency by a reduced tool length. The developed algorithms utilize the maximum feed rate allowed by the given constraints in each region (roughing, semi-finishing and finishing) that the number of teeth required in each region is minimized.

1.2 Problem Definition

Feed rate, depth of cut and cutting speed are three main parameters in all machining processes. Due to the nature of broaching process, in contrast to other machining processes, feed rate and depth of cut are embedded in tool design and the only parameter that can be modified during the operation is the cutting speed (see Figure 1-4). This situation makes the tool design the most important aspect in broaching.

Thus, modeling of cutting process and accurate prediction of critical parameters before manufacturing broaching tool can be very helpful.

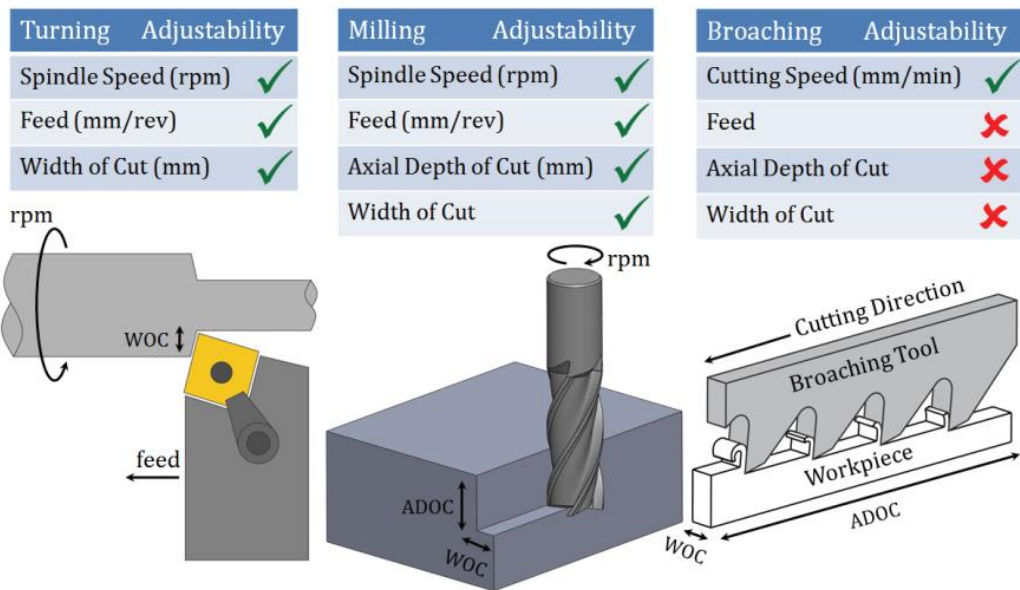

Figure 1-4. Cutting parameters in turning, milling and broaching[23].

Since broaching is one of the least studied processes in literature, broaching tool design and process are based more on experience than scientific knowledge. There is no model for optimum tool design and it may cause losses in production time, reduced quality of produced parts and increased broaching process cost. In order to optimize broaching tool design cutting force is one of the most significant constrains. Variable cutting forces, applied on broach teeth cause various problems such as reduced tool life, chipping, tooth breakage, bad surface quality etc.(see Figure 1-5).

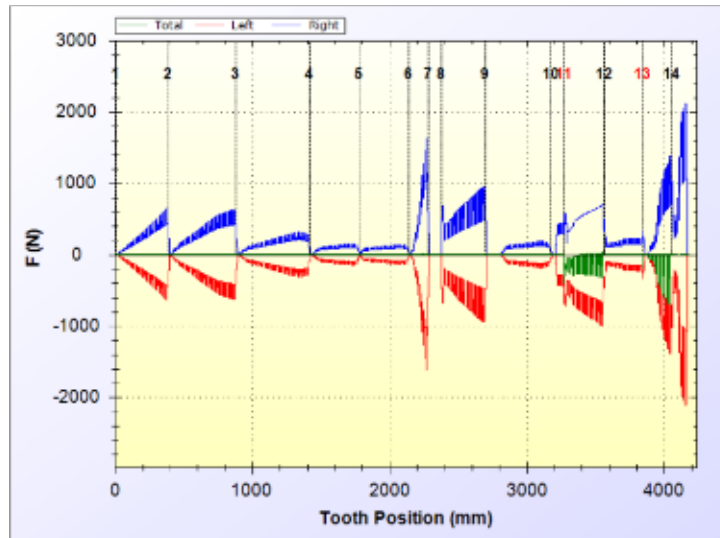

Figure 1-5 Variable cutting forces applied on broaching teeth [24].

Designing broaching tool by leveling cutting forces throughout the roughing and semi-finishing operations, which is main objective of this study, can improve tool life by preventing problems, which mentioned above (see Figure 1-6). In this method, each tooth has different shape from previous one. Rise per tooth is changed all over the broaching tool to achieve constant cutting forces in each tooth in roughing or semi-finishing step. Optimization applied in this study in order to design each tooth shape and objective of optimization is getting constant cutting forces. Therefore, maximizing cutting forces by considering machine power is resulted minimum broach tool length.

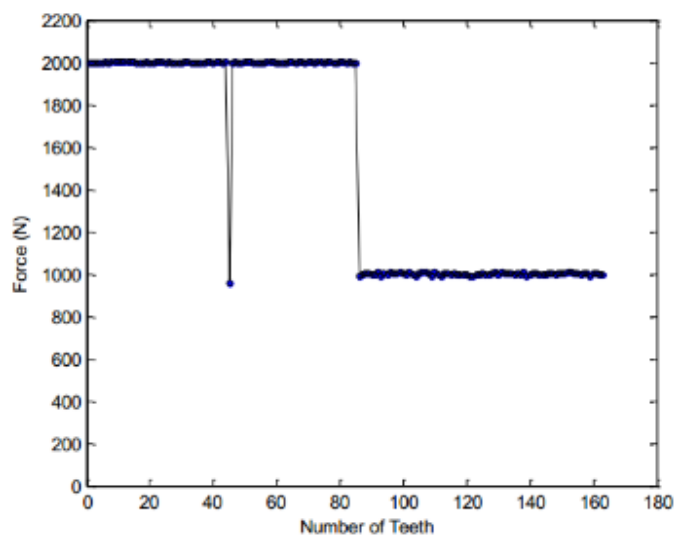

Figure 1-6 Constant cutting forces in roughing and semi-finishing step.

Geometrical optimization of broaching tools can improve current broach designs. Various advantages such as shortened tool length, process time reduction, elimination of tooth breakage and improving final part quality leading to reduction of whole production cost could be achieved by optimization.

1.3 Research Motivation

One of the most significant and difficult parts machined by broaching operations is turbine disk fir-tree slots due to complex geometry and very tight tolerances of these slots. Fir-tree slots are the spaces in turbine disks into which blades' fir tree roots fit. (Figure 1-7)

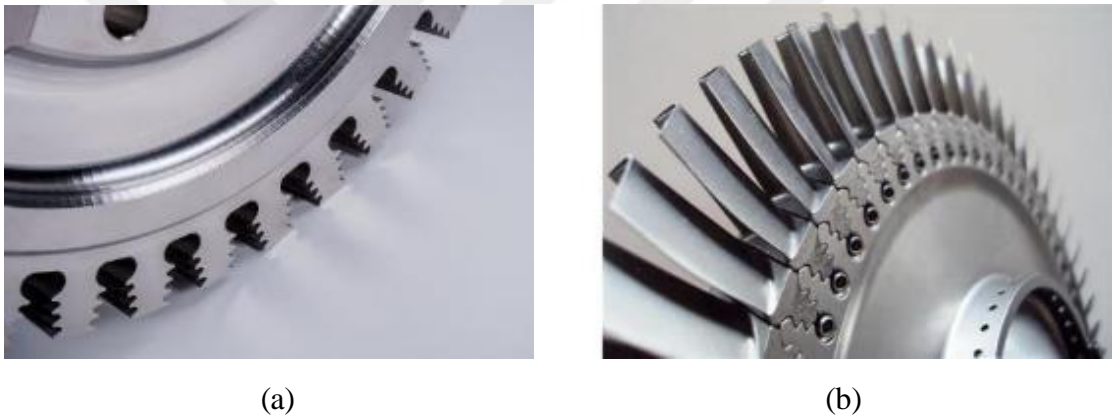

Figure 1-7. (a) Fir-tree slots on turbine disk (b) Turbine disk joints with blades.

These parts operate through extremely high pressures, temperatures and rotational speeds during the operation of the engine, therefore very tight dimensional tolerances, good surface finish and integrity are required to produce these parts. In order to fulfill these high requirements, the cutting parameters as well as tool, fixture and machine tool are critical factors. Broaching tool design directly affect these critical features on precise parts.

In this study, geometrical optimization of broaching tool design for machining of fir-tree slots by leveling of cutting forces is presented. The aim of this work is to introduce an algorithm, which generates teeth profile based on constant cutting forces for roughing, semi-finishing and finishing operations during broaching. The proposed approach is

different from the previous ones, as they have not considered shape optimization for each tooth to keep cutting forces constant during roughing and semi-finishing. For instance Vogtel et al.[22] presented a geometrical and technological optimization of broaching tool design without considering constant cutting forces. Their optimization is based on maximum allowed rise per tooth and variable cutting forces is allowed in their algorithm. Therefore, constant cutting forces during each section is the most critical differences between this study and previous ones.

In this work, a method is developed to minimize the length of the broach tool, increase tool life and quality of the final part, which resulted reducing the whole process cost.

1.4 Layout of Thesis

The thesis is organized as follows:

In Chapter 2, the proposed models for the simulation of orthogonal and oblique cutting in broaching process and variation of rake and inclination angle in different cutting edges are presented. Moreover, variation of approach angle due to curvature of fir-tree slots in semi-finishing region is demonstrated. The detailed calibration tests for cutting force coefficients calculations, which depend on the tool and workpiece material, are also provided.

In Chapter 3, the various methods used for the teeth generation in different regions of the broaching tools such as roughing, semi-finishing and finishing are presented. In each region various approaches are used for automatic teeth generation. Also, all the developed methods in this study are simulated by MATLAB®.

In Chapter 4, simulation results are demonstrated. Number of teeth and shape of the generated teeth in roughing, semi-finishing and finishing sections are presented by considering various cutting forces, rake, inclination and approach angles. Moreover this chapter include some discussion about the results of teeth generation and effect of edge forces on semi-finishing teeth's generation.

In Chapter 5, the summary of the thesis is presented along with major conclusions as well as discussions.



Chapter 2. BROACHING PROCESS MODELING

In this chapter, the modeling of broaching process is presented. Force prediction is the main requirement for evaluation of the machining processes. Although turning, milling and drilling are the most common cutting operations and broaching, boring, shaping and form cutting are the special ones, All machining operations share the same principles in terms of process mechanics. However, their kinematics and geometry are different. Orthogonal and oblique cutting are common basic cutting models used for various machining operations and are discussed in the following sections in more detail.

2.1 Mechanics of Orthogonal Cutting

In orthogonal cutting, the material removal is done by a cutting edge, which is perpendicular to the direction of relative tool-workpiece motion. General mechanics of machining is explained by two-dimensional orthogonal cutting, however most common cutting operations are three-dimensional. In most cases, geometrical and kinematic transformation models applied to the orthogonal cutting process are used to describe the mechanics of more complex three-dimensional oblique cutting operations [25]. Schematic representations of orthogonal cutting processes are shown in Figure 2-1. Cutting edge and cutting velocity (V) are perpendicular to each other in orthogonal cutting. Raw material that sheared in orthogonal cutting from workpiece has width of cut (b) and depth of cut (h) and cutting is assumed uniform through the cutting edge.

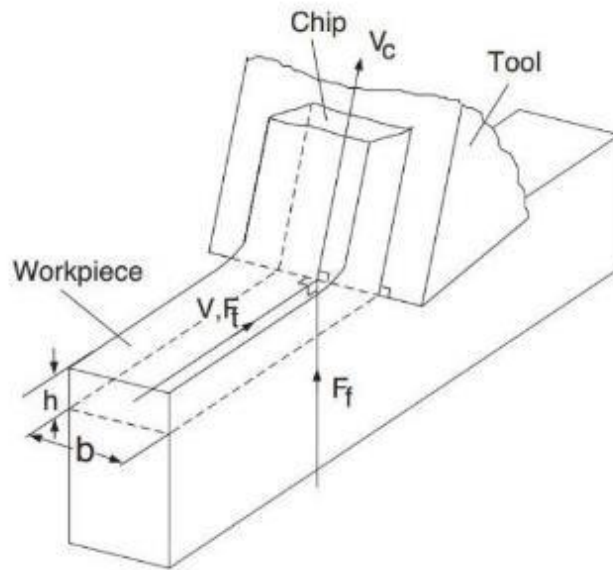

Figure 2-1 Orthogonal cutting geometry [25].

All cutting processes contain three deformation zones as shown in the cross-sectional view of the orthogonal cutting (see Figure 2-2).

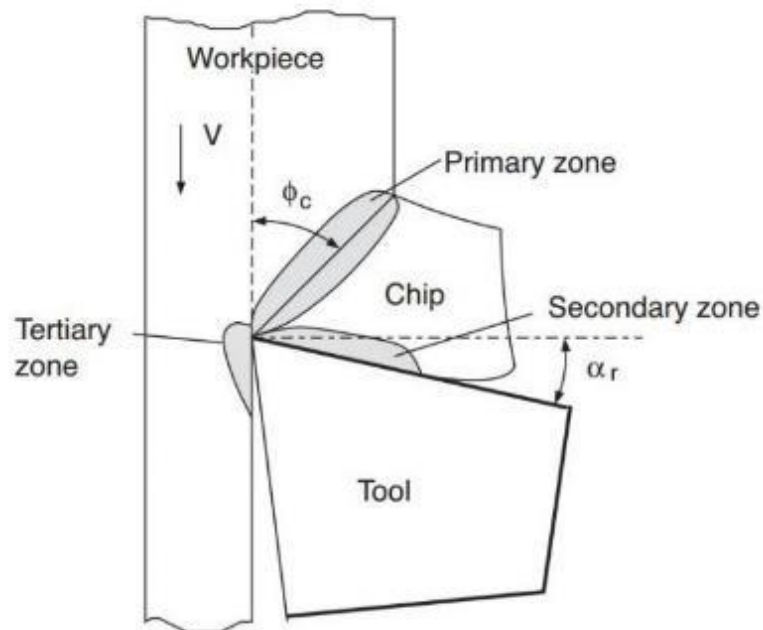
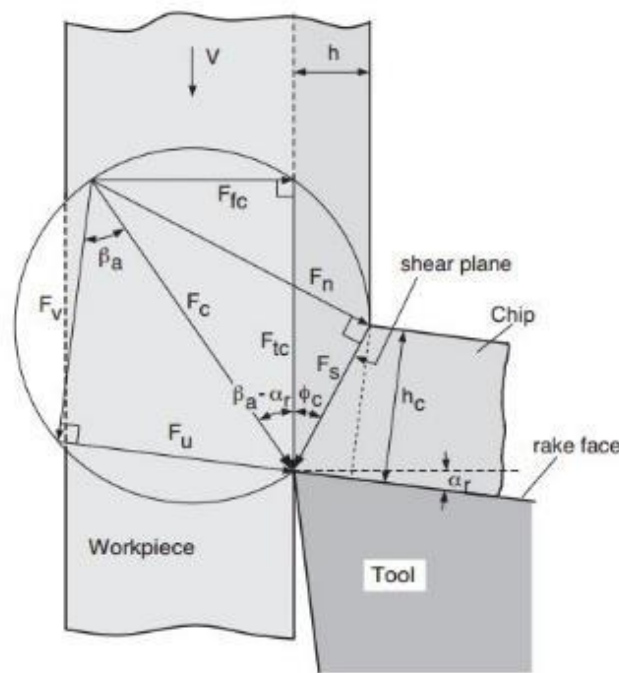

Figure 2-2 Three deformation zone in orthogonal cutting [25].

In order to form a chip, the material is sheared at the primary shear zone by penetration of cutting edge into the workpiece. The chip after shearing deforms and moves along the

rake face of the tool, which is called the “second zone”. Tertiary deformation zone is the place where the flank face of tool rubs the newly machined surface [26] (Figure 2-2).

There are two basic assumption in the primary shear zone analysis. Merchant [27] assumed primary shear zone as a thin plane in order to model orthogonal cutting. On the other hand, Lee [28] and Palmer et al.[29] based their analysis on a thick shear deformation zone assumption. In this study, Merchant’s method is used to develop an orthogonal cutting model for broaching. The geometry of deformation and cutting force directions are shown in (Figure 2-3).



Cutting force diagram

Figure 2-3 Cutting force diagram [25].

The angle between the cutting speed direction (V) and the shear plane is called the shear angle (β_c). Force equilibrium resulted that the resultant force (F_c) is formed from the tangential (F_{tc}) and feed (F_{fc}) cutting forces:

$$F_c = \sqrt{F_{tc}^2 + F_{fc}^2} \quad (2-1)$$

The tangential cutting force is in the direction of cutting velocity and the feed force is in the direction of uncut chip thickness. The shear force can be derived from the geometry:

$$F_s = F_c \cos(\phi_c + \beta_a - \alpha_r) \quad (2-2)$$

The chip compression ratio (r_c) is the ratio of the uncut chip thickness over the deformed one:

$$r_c = \frac{h}{h_c} \quad (2-3)$$

Shear force can be calculated as a function of shear angle and shear stress (τ_s) as follows:

$$F_s = \tau_s b \frac{h}{\sin \phi_c} \quad (2-4)$$

From equation (2-2) and (2-4), the resultant cutting force (F_c) is derived in terms of shear stress, shear and friction angle, feed rate and width of cut as follows [25]:

$$F_c = \frac{F_s}{\cos(\phi_c + \beta_a - \alpha_r)} = \tau_s b h \frac{1}{\sin \phi_c \cos(\phi_c + \beta_a - \alpha_r)} \quad (2-5)$$

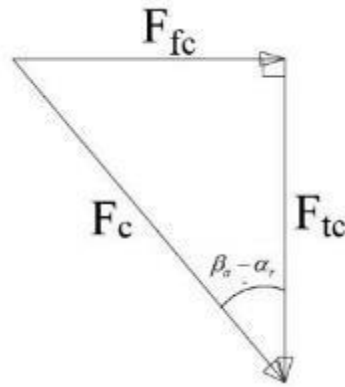

Figure 2-4 Cutting force components.

As can be derived from diagram tangential and feeding forces can be expressed in terms of resultant force as follow:

$$\begin{cases} F_{tc} = F_c \cos(\beta_a - \alpha_r) \\ F_{fc} = F_c \sin(\beta_a - \alpha_r) \end{cases} \quad (2-6)$$

Shear angle can be derived from the geometry of cutting that illustrated in Figure 2-3 as follows [25]:

$$\phi_c = \tan^{-1} \frac{r_c \cos \alpha_r}{1 - r_c \cos \alpha_r} \quad (2-7)$$

In order to find the main cutting force, Eq.(2-5) must be substituted into Eq.(2-6). This results in prediction of cutting forces as functions of cutting conditions such as uncut chip thickness (h) and width of cut (a), tool geometry and process-material dependent terms such as; $\alpha_r, \beta_a, \phi_c$ and τ_s as follows:

$$F_{tc} = bh \left[\tau_s \frac{\cos(\beta_a - \alpha_r)}{\sin \phi_c \cos(\phi_c + \beta_a - \alpha_r)} \right] \quad (2-8)$$

$$F_{fc} = bh \left[\tau_s \frac{\sin(\beta_a - \alpha_r)}{\sin \phi_c \cos(\phi_c + \beta_a - \alpha_r)} \right] \quad (2-9)$$

Feed and tangential cutting coefficients determines as Eq.(2-10)&(2-11) in various metal cutting text books such as the machining of metals [30] as follows:

$$K_{fc} (N / mm^2) = \tau_s \frac{\sin(\beta_a - \alpha_r)}{\sin \phi_c \cos(\phi_c + \beta_a - \alpha_r)} \quad (2-10)$$

$$K_{tc} (N / mm^2) = \tau_s \frac{\cos(\beta_a - \alpha_r)}{\sin \phi_c \cos(\phi_c + \beta_a - \alpha_r)} \quad (2-11)$$

The cutting force in orthogonal broaching similar to almost all of the orthogonal cutting processes, can be expressed by two different components which are related to uncut chip thickness and the length of cutting edge [25].

$$\begin{cases} F_t = K_{tc}bh + K_{te}b \\ F_f = K_{fc}bh + K_{fe}b \end{cases} \quad (2-12)$$

Eq.(2-12) has been used in this study to predict forces and modeling of orthogonal broaching tools with zero inclination angles.

2.2 Mechanics of Oblique Cutting

Unlike orthogonal cutting, oblique cutting has been done by cutting edges, which has angle with cutting velocity (V). In this kind of machining, the cutting edge is oriented with an inclination angle (i). Schematic representations of oblique cutting processes is shown in Figure 2-5.

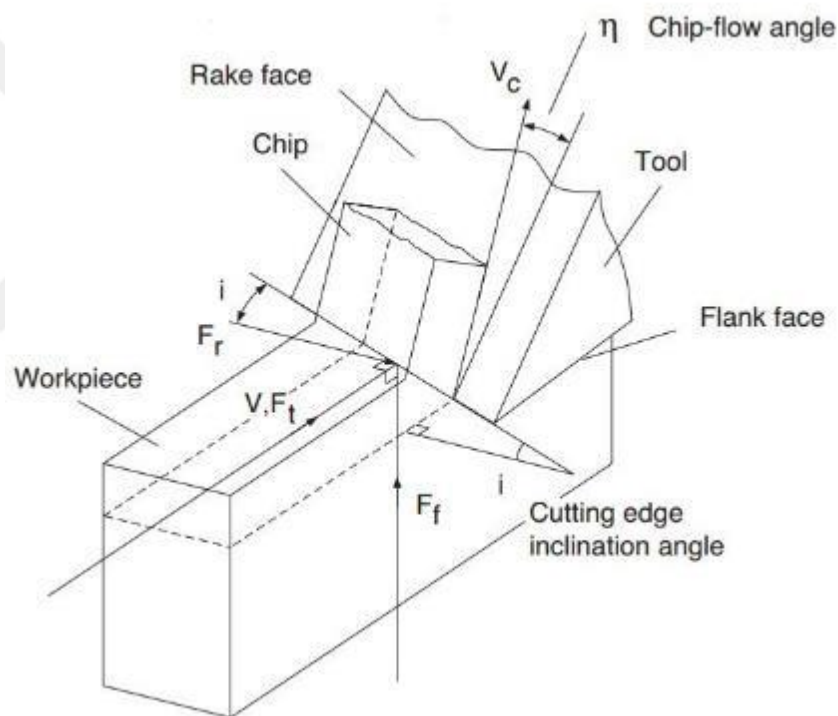

Figure 2-5 Oblique cutting geometry [25].

In oblique cutting the cutting velocity has inclination angle, and thus the direction of shear, chip flow, friction and vectors of resultant force have components in three directions (see Figure 2-6). As resulted from the Figure 2-6 the X-axis lies on the cut surface and it is perpendicular to the cutting edge, Y is in direction of cutting edge and Z is perpendicular to XY plane.

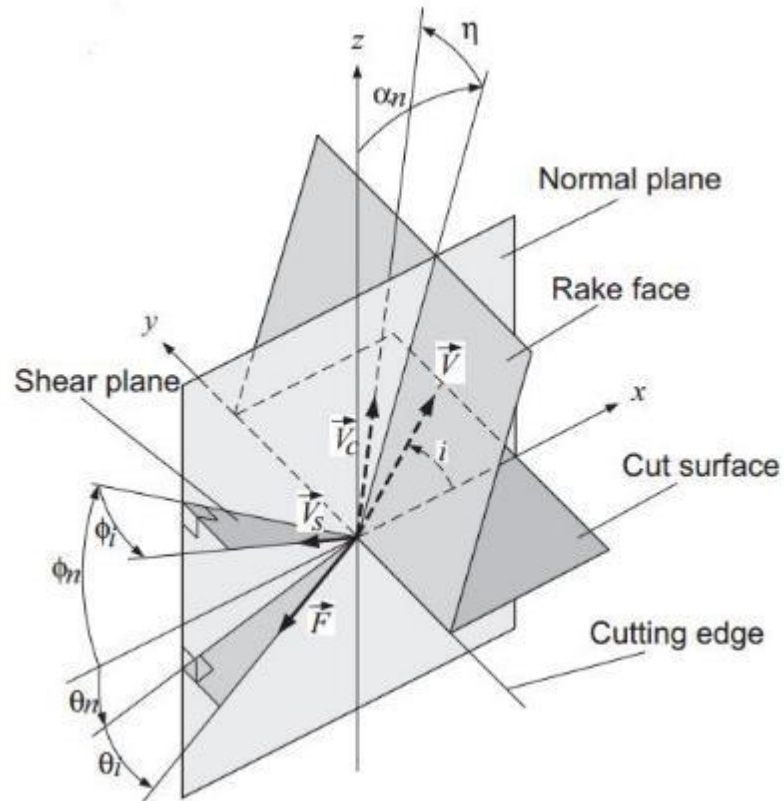

Figure 2-6 Geometry of oblique cutting [25].

Merchant [31] present following geometric relation between the chip flow (η) and shear direction and this equation defines oblique cutting process relations:

$$\tan \eta = \frac{\tan i \cos(\phi_n - \alpha_n) - \cos \alpha_n \tan \phi_i}{\sin \phi_n} \quad (2-13)$$

where (i) is inclination angle, (ϕ_n) is normal shear angle, (ϕ_i) is oblique shear angle and (α_n) is normal rake angle.

2.2.1 Prediction of Shear Angle (Oblique cutting)

As for orthogonal cutting there are two different theoretical approaches to prediction of shear angle in oblique cutting as presented in the following:

2.2.1.1 Maximum shear stress principle

Krystof [32] and Lee [28] presented this principle to prediction of shear angle in orthogonal cutting. In order to derive shear angle by using this principle for oblique cutting five unknown angles $(\phi_n, \phi_i, \theta_n, \theta_i, \eta)$ that describe the mechanics of oblique cutting should be defined. To find these angles direct analytical solution is rather difficult. Therefore, these angles are defined by iterative numerical method according to the block diagram, which is shown in Figure 2-7.

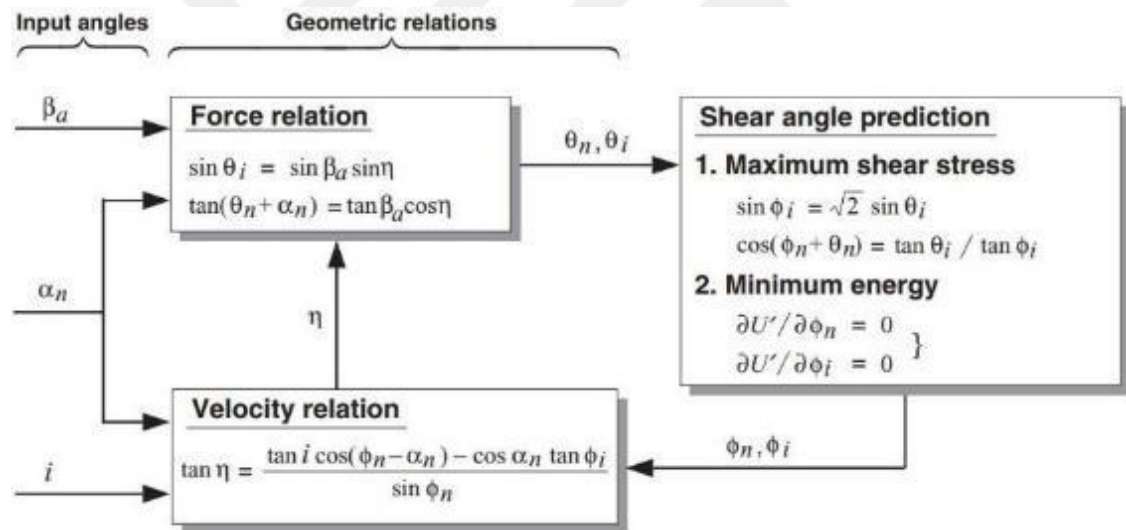

Figure 2-7 Solution procedure of shear angle [25].

In this method, normal rake (α_n), friction (β_a) and inclination (i) angle are determined from the geometry of tool and material tests and these parameters imported to the algorithm as inputs. An initial value for chip flow angle (i.e. $\eta = i$) that proposed by Stabler [33] is assumed to start iterative solution. In the next step, (θ_n) and (θ_i) which are the directions of the resultant force vector, can be calculated by force relation

equations. The calculated values can be used for shear angle prediction. After calculation of (ϕ_n) and (ϕ_i) by maximum shear stress principles, they are imported to the velocity relation equation and (η) can be calculated. Then the calculated value of chip flow (η) is imported to the force relation equations and these steps continues until converging of (η) within 10^{-12} percent. This block diagram can be used for predicting shear angle for orthogonal cutting in which inclination angle is zero and therefore (ϕ_i) and (θ_i) are also zero. By obtaining $(i = \phi_i = \theta_i = 0)$ as an input in the discussed block diagram (Figure 2-7 Solution procedure of shear angle [25]) ϕ_n can be calculated as Eq.(2-14) [25];

$$\phi_n = \frac{\pi}{4} - (\beta_a - \alpha_r) \quad (2-14)$$

2.2.1.2 Minimum energy principle

Merchant [34] presented minimum energy principle for predicting shear angle in orthogonal cutting. To predict shear angle for oblique cutting by using minimum energy principle iterative solution method should be applied which presented by block diagram in Figure 2-7. In this method like shear angle prediction with maximum shear stress principle (α_n) , (β_a) and (i) are imported to the algorithm as inputs. The first assumption of chip flow angle that proposed by Stabler [33], which is $(\eta = i)$, is used for first of iterative solution. Then, force relation equations are used for calculating (θ_n) and (θ_i) , that are the directions of the resultant force vector. In the next step, (ϕ_n) and (ϕ_i) can be calculated by minimum energy principle which illustrated in Figure 2-7 and they are used for chip flow angle calculation in velocity relation. The calculated chip flow angle (η) must be imported to the force relation equations and these procedure is continued until converging of chip flow angle within 10^{-12} percent [25].

By applying this method for orthogonal cutting, it results the same result of shear angle which predicted by Merchant [34] with minimum energy principle. Inputs for using this iterative method to find shear angle in orthogonal cutting is ($i = \phi_i = \theta_i = 0$) and the result is:

$$\phi_n = \frac{\pi}{4} - \frac{(\beta_a - \alpha_r)}{2} \quad (2-15)$$

2.2.1.3 Empirical approach for shear angle prediction

Instead of numerical and analytical method for predicting shear angle in cutting process there are a number of experimental models. The model which used in this study is presented by Armarego and Whitfield [35]. There are two assumption in their model to prediction of shear angle as follows: a) the shear velocity is collinear with shear force and b) the chip length ratio is same in both orthogonal and oblique cutting. The Stabler's [33] assumption is also considered as one of the maximum shear stress criteria. Eq. (2-16) is yielded by combining three geometric equations, which derived in previous section:

$$\tan(\phi_n + \beta_n) = \frac{\cos \alpha_n \tan i}{\tan \eta - \sin \alpha_n \tan i} \quad (2-16)$$

where $\beta_n = \theta_n + \alpha_n$. Therefore, the following equation is resulted:

$$\tan \beta_n = \tan \beta_a \cos \eta \quad (2-17)$$

The second assumption which is mentioned above is made by Armarego and Whitfield [35] from their experimental works. Therefore, the normal shear angle can be resulted by following equation:

$$\tan \phi_n = \frac{r_c (\cos \eta / \cos i) \cos \alpha_n}{1 - r_c (\cos \eta / \cos i) \cos \alpha_n} \quad (2-18)$$

The three unknown angles such as (η) , (ϕ_n) and (β_n) are derived by solving these three equations. Stabler's [33] experimental chip flow rule which is (i.e., $\eta = i$) can be applied to solve Eq. (2-18) in order to avoid numerical iteration.

2.3 Prediction of cutting forces in oblique cutting

The resultant cutting force (F_c) can be defined by subtracting edge forces (F_e) from the measured force (F). the cutting forces in three direction of cutting speed (F_{tc}), the trust (F_{fc}) and the normal (F_{rc}) are derived by projection of resultant cutting force (F_c) as follow [25]:

$$\left. \begin{aligned} F_{tc} &= F_c (\cos \theta_i \cos \theta_n \cos i + \sin \theta_i \sin i) \\ &= \frac{\tau_s bh (\cos \theta_n + \tan \theta_i \tan i)}{[\cos(\theta_n + \phi_n) \cos \phi_i + \tan \theta_i \sin \phi_i] \sin \phi_n} \\ F_{fc} &= F_c \cos \theta_i \sin \theta_n \\ &= \frac{\tau_s bh \sin \theta_n}{[\cos(\theta_n + \phi_n) \cos \phi_i + \tan \theta_i \sin \phi_i] \cos i \sin \phi_n} \\ F_{rc} &= F_c (\sin \theta_i \cos i - \cos \theta_n \cos \theta_i \sin i) \\ &= \frac{\tau_s bh (\tan \theta_i - \cos \theta_n \tan i)}{[\cos(\theta_n + \phi_n) \cos \phi_i + \tan \theta_i \sin \phi_i] \sin \phi_n} \end{aligned} \right\} \quad (2-19)$$

The express format of cutting forces can be as follow:

$$\left. \begin{aligned} F_t &= K_{tc} bh + K_{te} b \\ F_f &= K_{fc} bh + K_{fe} b \\ F_r &= K_{rc} bh + K_{re} b \end{aligned} \right\} \quad (2-20)$$

The cutting force equations can be transformed into the following equations by using Armarego's classical oblique model and geometrical relations:

$$\left. \begin{aligned} F_{tc} &= bh \cdot \left[\frac{\tau_s \cos(\beta_n - \alpha_n) + \tan i \tan \eta \sin \beta_n}{\sin \phi_n \sqrt{\cos^2(\phi_n + \beta_n - \alpha_n) + \tan^2 \eta \sin^2 \beta_n}} \right] \\ F_{fc} &= bh \cdot \left[\frac{\tau_s \sin(\beta_n - \alpha_n)}{\sin \phi_n \cos i \sqrt{\cos^2(\phi_n + \beta_n - \alpha_n) + \tan^2 \eta \sin^2 \beta_n}} \right] \\ F_{rc} &= bh \cdot \left[\frac{\tau_s \cos(\beta_n - \alpha_n) \tan i - \tan \eta \sin \beta_n}{\sin \phi_n \sqrt{\cos^2(\phi_n + \beta_n - \alpha_n) + \tan^2 \eta \sin^2 \beta_n}} \right] \end{aligned} \right\} \quad (2-21)$$

2.4 Broaching tool geometry

Due to the nature of broaching process, machining is done with only linear motion of broaches by pushing through the work piece or pulling. If desired final part is complicated broaching tool geometry must be complicated also, because there is not any other motions to creating complex parts. In conventional machining such as milling and turning, the final part is quite different from the geometry of cutting tool. In these operations, the relative motion of tool and workpiece produces final part. There are a little differences between milling tools, either inserted or helical ones. For example, a milling tool can be manufactured by knowing some variables such as the tool diameter, number of inserts, helix angle etc. Moreover turning tools also can be produced by defining of rake angle, oblique angle, hone radii, nose radii etc. Figure 2-8 demonstrates milling and turning tools.

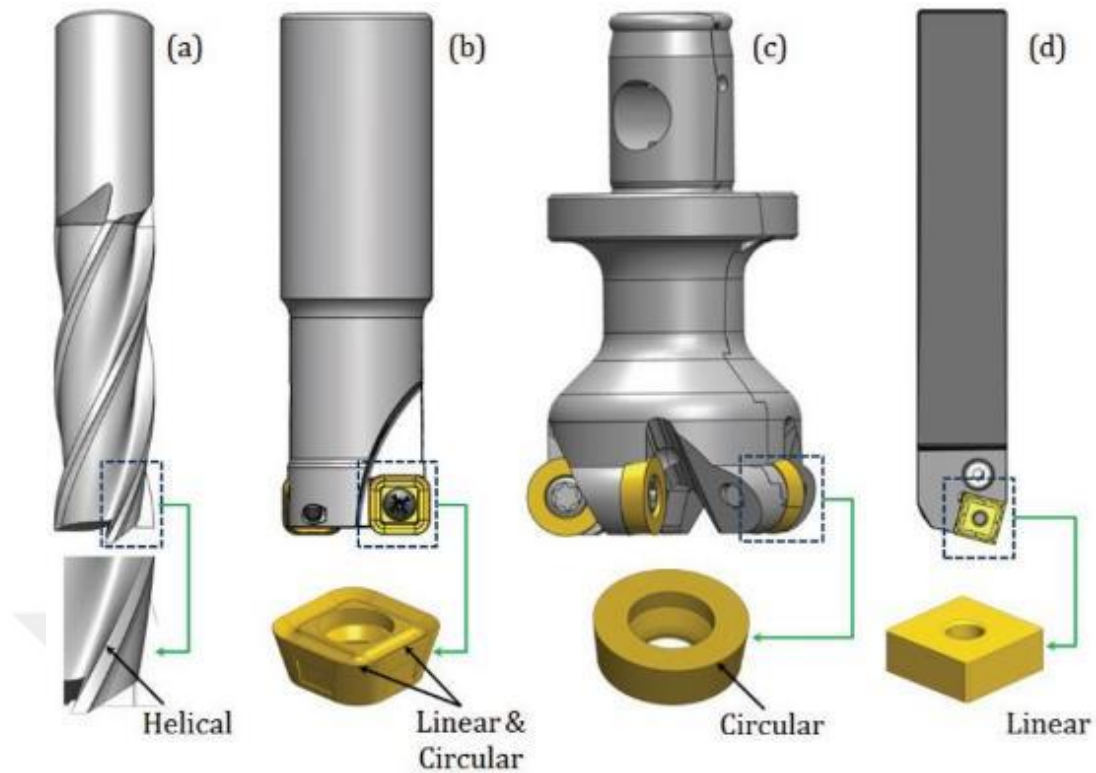

Figure 2-8 Cutting edges for: a) End mill tool. b) Indexable end mill.
c) Face mill. d) Turning tool.

In contrast with the mentioned machining operations, broaching tools have various geometries similar to the desired profile to be manufactured on the workpiece. Two main categories of broaches are internal and external broaching tools[1]. In internal broaching tools, the exterior shape of broaches are matched the final profile. In this operation desired profile is shaped by pushing or pulling the tool through a hole, which is drilled or cored previously on the workpiece to allow the tool go through. In external broaching, the workpiece must be clamped firmly by a fixture to the machine table. This operation is done by tool, which has a shape suitable to the desired profile with passing over the raw material to produce final shape on the surface of workpiece. For example round tools must be used for machining of circular parts or single keyways are machined with the broaches that has rectangular shape.

The broaching tools include two different profile such as: front profile and side profile. The front profile varies according to the desired final shape while in all broaches the

side profile is almost similar. Different shapes of broaching tools demonstrated in Figure 2-9.

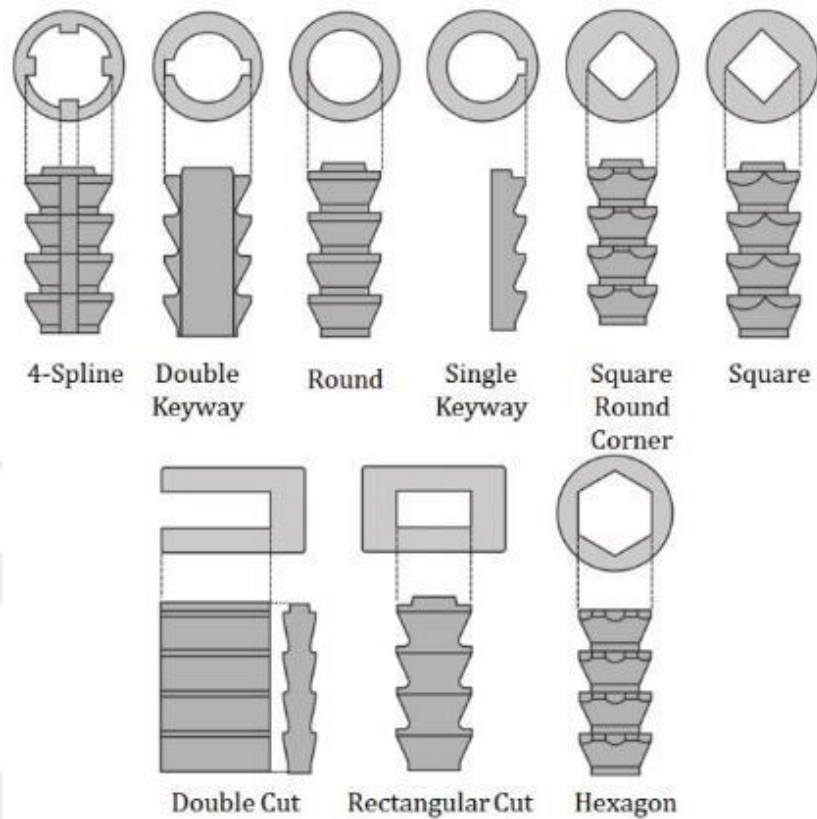

Figure 2-9 Front profiles in some broaches.

Figure 2-9 shows that the front plane shape depends on desired workpiece geometry and it has to be designed accordingly. It varies from a single keyway to hexagonal ones. Fir tree slots that used in turbine disks are the most complicated geometries which produced by the broaching processes because of their tight tolerances. In this study, optimization of fir-tree tools are presented. However, the side profiles as it was mentioned above are similar in the most broaching tools. The side profile geometry of typical broach is shown in Figure 2-10. The key features of broaching tool such as pitch length (P), rake angle (α), clearance angle (γ) and rise per tooth are defined in side plane.

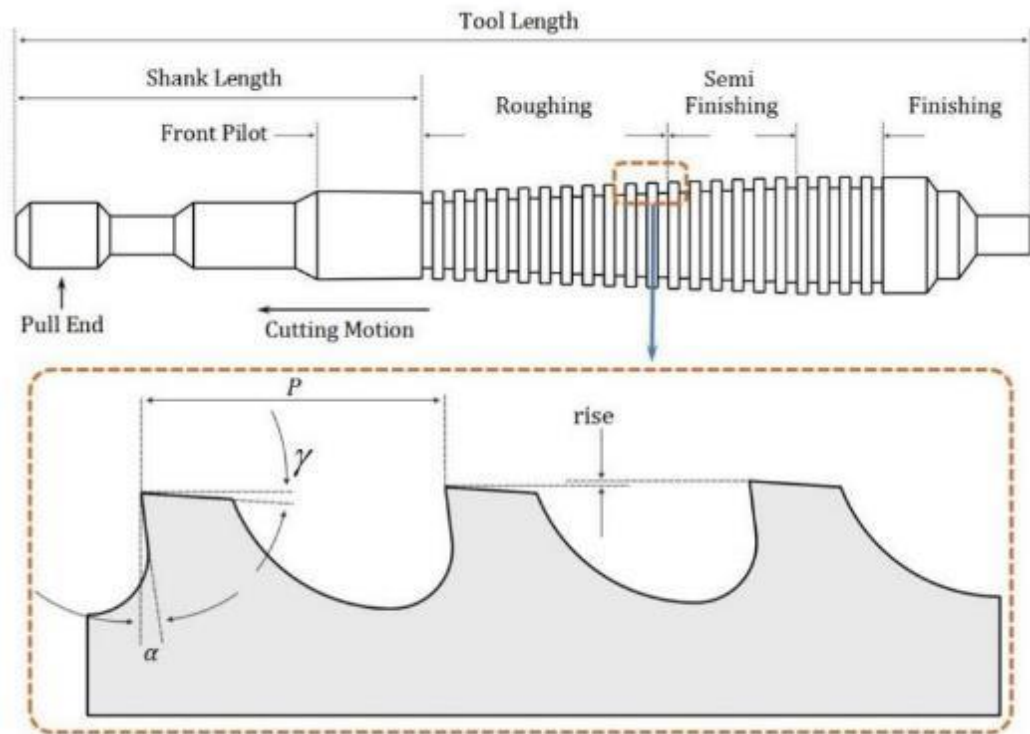

Figure 2-10 Side view of typical broach.

Figure 2-11 demonstrates cutting angles on a broach tooth in both side view and top view. In which, (α) is the rake angle and the inclination angle is represented by (i).

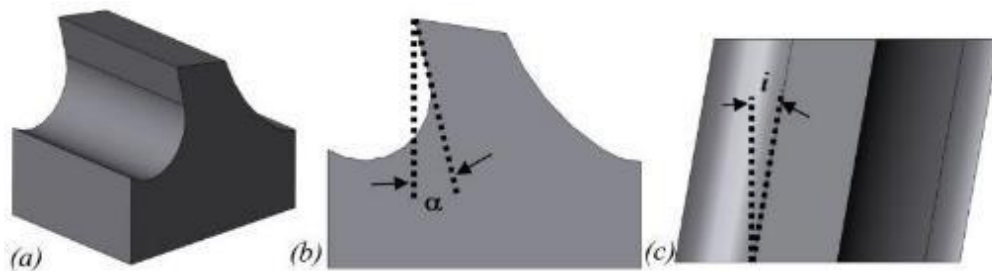

Figure 2-11 Cutting angles: a) 3D view b) Side view c) Top view.

2.4.1 Total broach length

The mechanical properties of workpiece and the material volume to be removed are two significant criteria for determining broaching tool. Pitch length and number of teeth also affect total length of broaching tool. In addition, broach length is limited by the broaching

machine parameters such as maximum length of the broach, which can be fitted into the machine's ram, and the stroke length.

2.4.2 Pitch length

The distance between two consecutive teeth on a broaching tool is pitch length, p (Figure 2-10), which is determined by the length and depth of the cutting tool, as well as the force required to operate by the broaching machine. In order to accommodate the produced chip in long workpieces, the greater pitch length is required. To minimize overall length of broaching tool, the tooth pitch in the finishing and semi-finishing region is smaller than the roughing step. However, pitch length is determined so that at least two cutting teeth are engaged simultaneously to prevent chattering and drifting[36].

2.4.3 Rake angle

The rake angle, α (Figure 2-10), is the angle between the tool cutting face and the normal plane of machined surface. Although, various rake angles from negative to positive values can be used in different machining operations, in broaching tools, it is generally positive. The cutting tool is sharpened by the positive rake angle. Moreover, the positive rake angle reduces required power for machining and smoother chip flow over the tool rake face. Increased rake angle results in lower cutting forces and tooth strength while small rake angles increase the cutting forces and the tooth strength.

2.4.4 Clearance angle

As can be determined from Figure 2-10, the clearance angle (γ), is the angle of tool flank face orientation from the cutting velocity. In order to eliminate interface of the tool and machined surface of the final part and friction reduction, clearance angle is built to provide adequate space between the back of the tool and workpiece.

2.4.5 Rise per tooth

The rise per tooth (Figure 2-10), also known as feed per tooth, is the difference between two consecutive teeth heights, which determines uncut chip thickness. In this study, rise per tooth is not constant through the teeth of broach tool. For each tooth, rise per tooth is calculated with developed algorithm by considering constant cutting forces applied on each tooth in every step of broaching.

2.5 Broaching mechanics

The cutting mechanics are changed along a cutting edge due to local cutting angles variation. The linear oblique cutting force model (see Eq.(2-21) and Figure 3-9), which is mentioned in previous sections, is used to calculate local cutting forces in three cutting direction after identification of the local angles for each tooth [25]:

$$\left\{ \begin{array}{l} F_t^i = K_{tc}^i f_i b_i + K_{te}^i b_t \\ F_f^i = K_{fc}^i f_i b_i + K_{fe}^i b_t \\ F_r^i = K_{rc}^i f_i b_i \end{array} \right\} \quad (2-22)$$

where each cutting point on the cutting edge is represented by superscript i , F_t^i, F_f^i, F_r^i represented the local tangential, local feed and local radial forces, the cutting force coefficient in the tangential, feed and radial forces are represented by $K_{tc}^i, K_{fc}^i, K_{rc}^i$ and the edge force cutting coefficients are represented by K_{te}^i, K_{fe}^i respectively. Calibration test which proposed by Armarego et al.[35] and Budak et al.[37] should be carried out in order to identify these cutting force coefficients. To include the effect of inclination angle, the data must be transformed to oblique cutting conditions, considering the calibration condition is orthogonal.

As discussed before, the aim of this study is to develop an optimization approach for intermediate teeth generation by leveling of the cutting forces. Thus, the method that used for cutting force calculation in broaching operation is one of the most significant steps of this study.

Cutting forces can be calculated in three various directions such as tangential, feed and radial cutting forces for oblique cutting conditions. In broaching operation due to geometry of this process tangential cutting force plays significant role in cutting force calculation. However, feed and radial forces can be ignored due to several reasons. First of all, feed cutting forces can be eliminated from cutting force calculation because this force is applied on each broaching tooth root and the root of each broaching tooth is the most stable part of broach's teeth. Therefore, feed cutting force has not so much effect on creating mentioned problems since in this study the optimization is accomplished in order to eliminate problems which occurred at the cutting edge not at the root of each tooth (see Figure 2-12). On the other hand, the radial cutting force generated in oblique cutting may be cancelled out from cutting force calculation because of symmetric shape of broaching tools in general. Therefore, in general broaching tools and tools which used for manufacturing fir-tree slots as well, the radial cutting forces own opposite direction. Thus, these forces cancel each other and does not cause significant problems during material removing in broaching operation (see Figure 2-12). As a consequent, in this study calculation of cutting forces in tangential direction is at the focus as variation of tangential cutting forces is the source of many problems such as reduced tool life and chipping, tooth breakage, poor surface quality. In this regard, design of teeth to level tangential cutting forces can eliminate these problems.

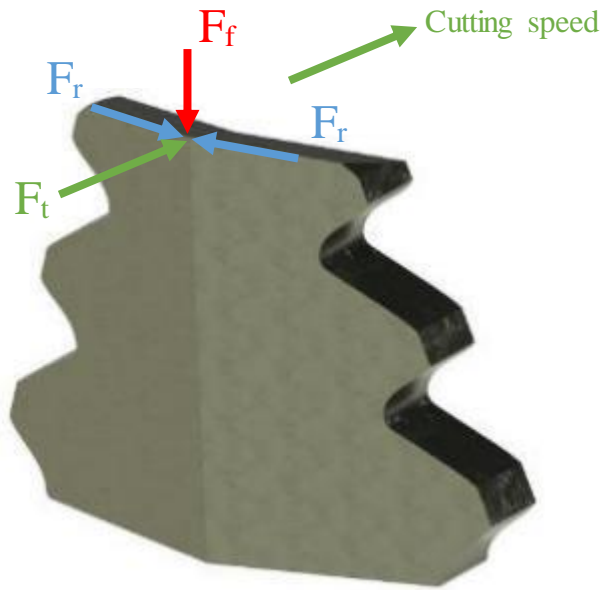

Figure 2-12 Cutting Forces directions.

In order to predict tangential cutting force, first of all tangential cutting force coefficients must be calculated. In the first step, orthogonal database, which is the result of experimental works, must be imported to the algorithm. Then, these data should be transferred to the oblique cutting condition. The orthogonal database that is used in this study is illustrated in Table 3-1: Orthogonal database for Ti_6Al_4V alloy. Iterative calculation is needed for cutting force prediction because, cutting force coefficient determining is done by assuming a value for uncut chip thickness at the first step. Then, Tooth is generated by using this value as cutting force coefficient. In the next step uncut chip thickness must be determined by subtracting new tooth height from the previous one. After that, new cutting force coefficient must be calculated by updated uncut chip thickness. This process must be continued until converging cutting force coefficient and uncut chip thickness to constant values. After all, teeth generation is done by using this method. All these processes are discussed in detailed in the next chapter for generating finishing, roughing and semi-finishing intermediate teeth generation (see flow chart 3.2.2)

Chapter 3. INTERMEDIATE TEETH GENERATION

As discussed in previous sections, geometrical optimization that results in optimized teeth generation by leveling tangential cutting forces at each step of broaching operation is the main aim of this study. Therefore, intermediate teeth generation must be accomplished considering cutting forces. In this section, the developed methods are presented in order to accomplish teeth generation at different steps of the broaching process. The method used for the teeth generation at each step is different than each other. In the following section of this study, various inputs needed for the intermediate teeth generation and are discussed below.

3.1 Inputs needed for intermediate teeth generation model

Several inputs are needed in order to conduct the intermediate teeth generation algorithm which are listed below:

- **Last tooth shape:** In almost all broaching tools, the last tooth shape is the desired shape that has been manufactured on the workpiece. It can be very simple shapes such as keyways or complicated ones like fir-tree slots, which are used in turbine disks. In this study, the last shape is considered as fir-tree slots. The last tooth shape is imported to the algorithm with coordinates of points which form the desired final tooth.(see Figure 3-1)

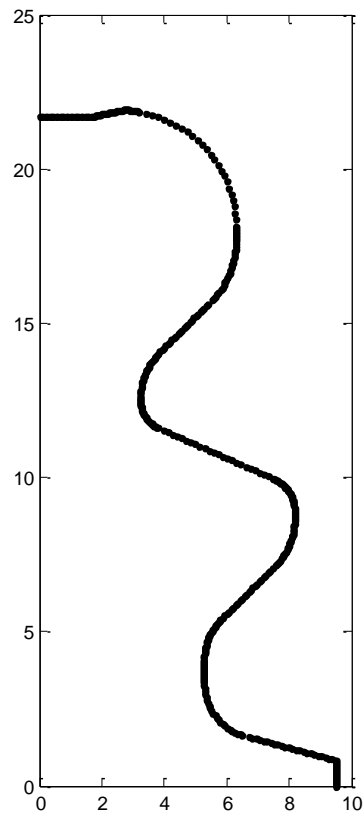

Figure 3-1 Last tooth shape.

- **First tooth dimensions:** In broaching tools, the roughing section generally has a rectangular shape because it is one of the easiest shapes for manufacturing. In this study, the first tooth shape is assumed to be rectangular. The user must input dimensions of the rectangle.
- **Uncut chip thickness for finishing step:** Each tooth in the finishing region must have an offset with the corresponding final tooth shape. The offsetting value is defined by the user as an input. (see Figure 3-2)

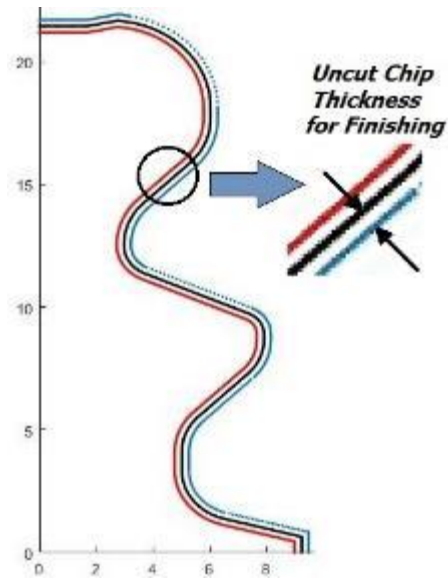

Figure 3-2 Uncut chip thickness at finishing step.

- **Approach angle at semi-finishing step:** This will be discussed in the later sub-sections.

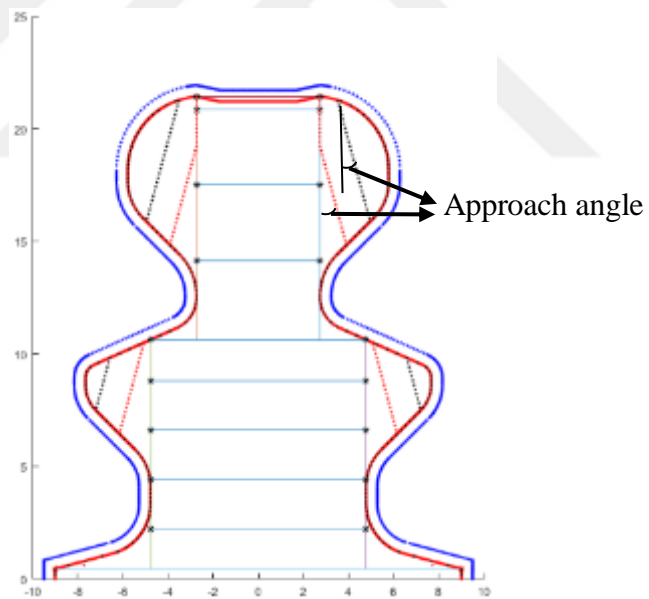

Figure 3-3 Approach angle at semi-finishing step.

- **Orthogonal database for the tool and workpiece couple (Table 3-1):** Orthogonal database is given by the user as an input to calculate the current cutting forces.

- **The limiting cutting force for the roughing step:** The user must input limiting cutting forces at the roughing step. Thus, intermediate teeth generation at the roughing step is accomplished considering the roughing limiting cutting force. Generating intermediate teeth with this limiting cutting force, keeps cutting forces constant in each tooth of roughing step.
- **The limiting cutting force for the semi-finishing step:** The user must input limiting cutting forces at the semi-finishing step. Thus, intermediate teeth generation at the semi-finishing step is accomplished considering the semi-finishing limiting cutting forces. Generating intermediate teeth with this limiting cutting force, keeps cutting forces constant in each tooth of the semi-finishing step and because of so many details at the semi-finishing region constant cutting force prevent occurring some problems such as tooth breakage, chipped tooth and poor surface.

3.2 Intermediate teeth generation methods

Geometrical categorization of the various broaching tools is helpful in conceptualizing the automatic computer aided tool design process. In the case of fir-tree slots, the intermediate teeth generation method is considered by process type, i.e. finishing, roughing and semi-finishing. In each process, various approaches were used for automatic teeth generation. In this study, the developed approaches for intermediate teeth generation began with the generation of the finishing teeth and continued with the generation of roughing and lastly the semi-finishing details. These approaches are presented in this sequence in the following sections. In addition, all the developed methods in this study were simulated by MATLAB®. The presented categorization is illustrated in Figure 3-4.

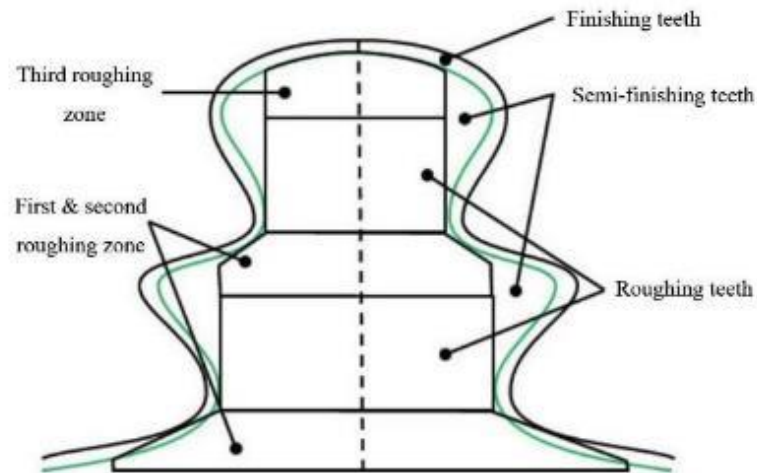

Figure 3-4 Various steps of the broaching process: Roughing, semi-finishing and finishing

3.2.1 Finishing intermediate teeth generation

As demonstrated in previous sections, desired final broaching tool shape can vary from simple to complicate. In this study, the final shape is selected as fir-tree slots. In order to generate finishing teeth there are two ways to accomplish intermediate teeth generation at the finishing step:

- **Importing uncut chip thickness and the finishing teeth number:** Uncut chip thickness and finishing teeth number are the most significant parameters which must be imported to the algorithm as inputs. The final shape was imported to the algorithm with the coordinates of the points which model the desired shape. Intermediate teeth in the finishing region must be offset of final tooth shape. Consequently, intermediate teeth in the finishing step were generated by offsetting last tooth shape with given uncut chip thickness as an input. The number of teeth in the finishing step is determined by the user.
- **Calculating cutting force in the finishing step:** This method is done by assumed uncut chip thickness and then dividing calculated cutting force to the desired cutting force and determining the teeth number at the finishing step. In this method, the user inputs the uncut chip thickness. Then the algorithm calculate the cutting force by considering the uncut chip-thickness and using Eq.(3-1), (3-2), (3-6) and (3-7).the teeth number

at the finishing step can be resulted by dividing calculated cutting force to the desired cutting force for this region.

Presented in this section is the offsetting algorithm for 2D point-sequence curves (PS-curve)[38]. Last tooth shape is formed by a polygon, which consist of short line segments (blue polygon in Figure 3-5). Moreover, to generate intermediate teeth in the finishing step new points must be generated. In order to do this, normal directions, which are perpendicular to each segment, were generated on each point of the last tooth shape. Points for the generated tooth were determined by considering uncut chip thickness, which is imported by user as an input. Two points resulted by using the normal line and uncut chip thickness. The point, which is in the inner region of the broaching tool must be selected as a generated point for intermediate tooth generation. Intermediate tooth generation in the finishing step was accomplished by connecting the points mentioned above (black and red polygon in Figure 3-5).

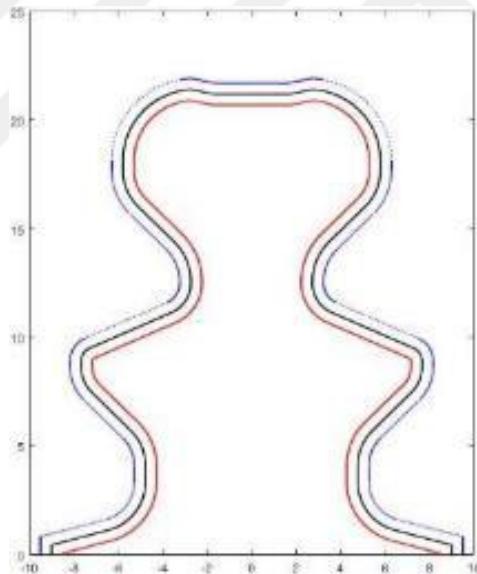

Figure 3-5 Finishing teeth of fir-tree broach.

However, the most significant limitations to the offsetting method occurred when the slope on the final tooth polygon is steep and the slope of segments changed suddenly. In these cases, the self-intersection removal method was used to eliminate invalid loops [38]. Figure 3-6 demonstrates invalid loops, which may occurred in broaching tool design as well.

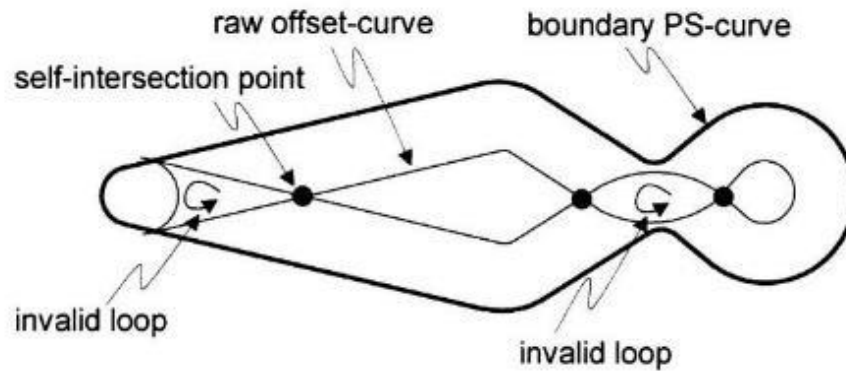

Figure 3-6 Invalid loops in offsetting[38].

3.2.1.1 Offsetting algorithm

The algorithm used in this study is illustrated in the following sub-section. First of all, the final tooth points are imported to the algorithm by the user. Then, at every point, the unit vector is obtained. After obtaining the unit vector at every point, the angle of these vectors must be calculated. The calculated vectors must be rotated by 90 degrees in order to find the normal vector at all points. Offsetted points are then generated by using offset value or uncut chip thickness at the finishing step. After generating all offsetted points, the intersections between segments must be computed. Removing self-intersection points is the next and most significant step in the offsetting algorithm. The algorithm must check points in four directions around each offsetted point to find candidates for self-intersection (i.e., right, left, above and below). Comparison between the trend of final tooth points and generated points must be applied to determine the points which must be deleted [39]. By connecting remaining offsetted points, intermediate teeth generation is accomplished; all these simulations are coded by MATLAB®.

The overall algorithm for the offsetting of the final tooth shape is as follows:

1. Importing the final tooth shape as an input in the point's coordinates format
2. Generating intermediate teeth by offsetting final tooth on a direction which is normal to final tooth segments with imported uncut chip thickness
3. Defining invalid loops which occurred in segments with a sudden slope change

4. Eliminating invalid loops
5. Connecting resulting points to create a polygon as an intermediate finishing tooth

3.2.2 Roughing intermediate teeth generation

In all machining processes, the maximum material removing is accomplished with roughing operation. Therefore, in broaching, maximum material removal with a minimum roughing broach teeth number is one of the most significant objectives of the roughing step.

The last intermediate tooth (the smallest tooth), which is generated in the finishing step is used to determine the boundaries of the roughing teeth. In order to define the boundaries of the roughing step, first of all boundary points (BPs), which are on the last generated finishing teeth, must be determined with an algorithm (see Figure 3-7).

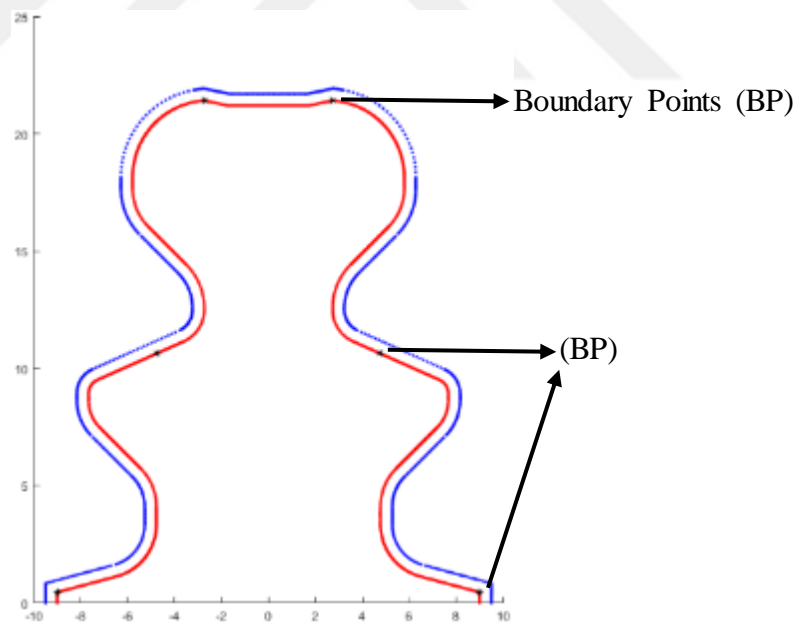

Figure 3-7 Boundary points on generated finishing curve.

In order to calculate boundary points, first of all critical points must be determined. As mentioned in the previous sub-section intermediate teeth are generated by connecting

generated points. To calculate critical points, slope of the lines which are formed between every two consecutive points must be calculated. Critical points are the points at which calculated slopes change suddenly. The lines' slope values can be changed from infinity to minus, infinity to positive, negative to positive and negative to zero on the determined critical points. Moreover, boundary points are defined by the intersection of vertical lines that pass through the critical points and the final generated finishing tooth curve. The boundary points determine the coordinates of the biggest roughing tooth in each zone of the roughing step (see Figure 3-8).

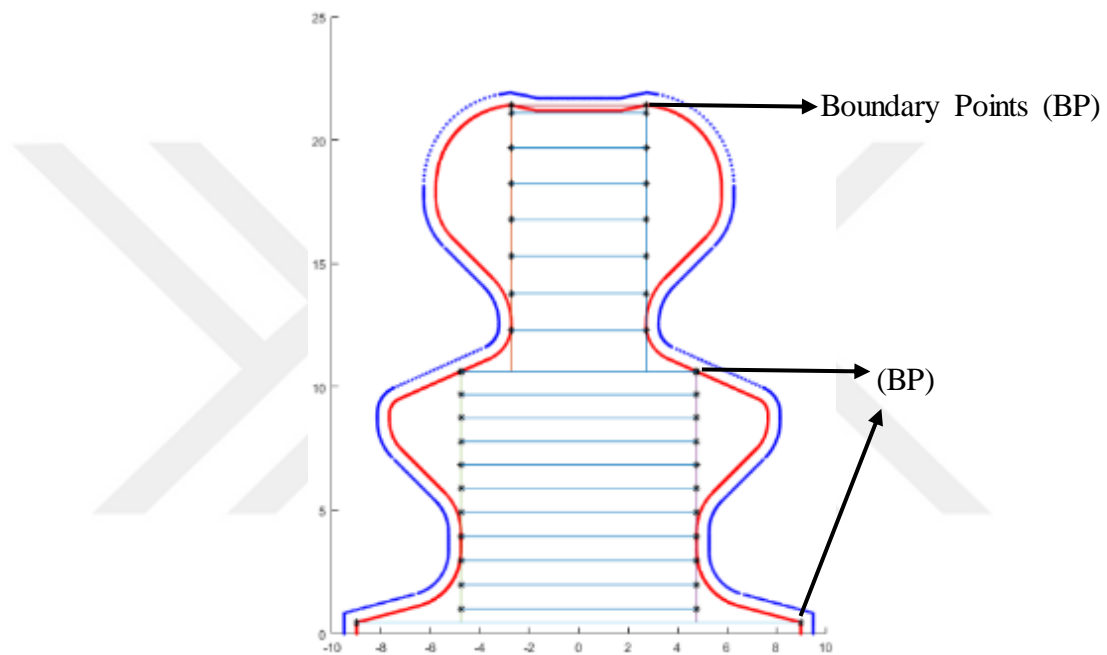

Figure 3-8 Boundary points on generated finishing curve with generated roughing teeth.

To calculate intermediate roughing teeth in the broaching process, first roughing tooth coordinates must be imported to the algorithm as an input. Furthermore, the dimensions of each intermediate roughing tooth which is generated by this algorithm are calculated by using Eq.(2-22). The developed algorithm accomplishes the intermediate teeth generation for both orthogonal and oblique cutting strategies; therefore, for each cutting tooth edges, local cutting angles must be calculated due to direction of cutting speed and cutting edge. For example, if rake angle for the first tooth is defined as 5° and inclination angle is zero, it could result in different situations along the vertical or horizontal cutting tooth edge. In this situation ($\alpha = 5^\circ$ and $i = 0$), for the horizontal cutting edge, rake angle

is 5° and inclination angle is zero. However, in the same situation ($\alpha = 5$ and $i = 0$), for the right vertical cutting edge, rake angle is zero and inclination angle is 5° , and for the left vertical cutting edge, rake angle is zero and inclination angle is -5° (see Figure 3-9).

Thus, the local rake angle and inclination angle for each roughing tooth can be calculated by using 3D geometrical relationships as follows [26]:

$$\alpha^j = 2\sin^{-1}\left(\cos(\kappa_j - \kappa)\sin(\alpha_n/2)\right) + 2\sin^{-1}\left(\sin(\kappa_j - \kappa)\sin(i/2)\right) \quad (3-1)$$

$$i^j = 2\sin^{-1}\left(\sin(\kappa_j - \kappa)\sin(\alpha_n/2)\right) - 2\sin^{-1}\left(\cos(\kappa_j - \kappa)\sin(i/2)\right) \quad (3-2)$$

where α^j is the local rake angle and i^j is the local inclination angle on each tooth, κ is the global side edge cutting, α_n is the global rake and i is the global inclination angle, respectively.

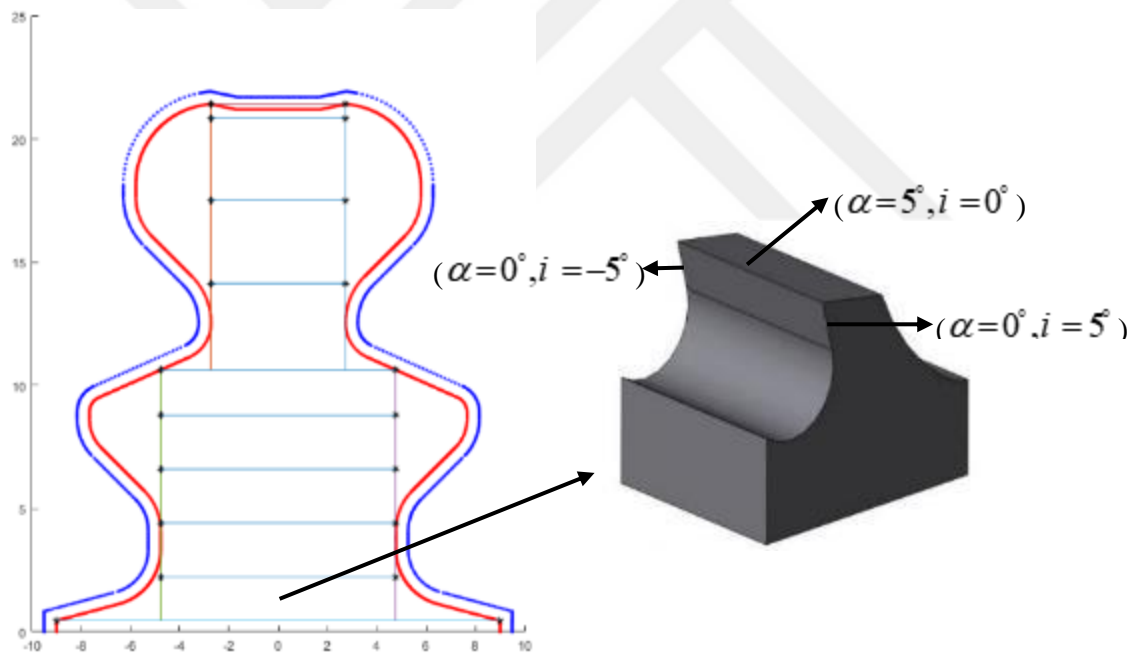

Figure 3-9 Local rake and inclination angle of broaching tools.

As demonstrated in second chapter of this study, in order to calculate the cutting force coefficients, the calibration test proposed by Armarego et al.[35] and Budak[37] must be performed due to the dependence of these coefficients on the material of the workpiece and the tool. Moreover, to include the inclination angle affect, the data obtained from the

orthogonal database must be transformed to oblique cutting. The material used in this study is Ti₆Al₄V alloy and the orthogonal database of this material is shown in Table 3-1:

Table 3-1: Orthogonal database for Ti₆Al₄V alloy.

Parameters	Equation
Rake angle (°)	$\alpha = 0$
Shear Stress (Mpa)	$\tau_s = 543$
Friction angle (°)	$\beta = 18.98 + 0.0788 \times \alpha$
Shear angle (°)	$\phi = \tan^{-1} \left(\frac{r_c \cos(\alpha)}{1 - r_c \sin(\alpha)} \right), r_c = c_0 h^{c_1},$ $C_1 = 0.239 - 0.0069 \times \alpha$ $c_0 = 0.985 - 0.0024 \times \alpha$
Cutting force coefficient at the tangential direction (N/mm)	$K_{tc} = \frac{\tau_s}{\sin \phi} \frac{\cos(\beta - \alpha) + \tan \iota \tan \eta \sin \beta}{\sqrt{\cos^2(\phi + \beta - \alpha) + \tan^2 \eta \sin^2 \beta}}$
Edge cutting force coefficient at the tangential direction (N/mm)	$K_{te} = 50.8$

As demonstrated earlier, first tooth dimension must be imported to the algorithm as an input. By knowing first tooth dimensions, cutting force coefficients are calculated by using the height of the first tooth as uncut chip thickness. To generate further intermediate teeth in the roughing step, the generated coefficient is used for next roughing tooth calculation. The new tooth is generated by using these coefficients. However, the height of each new tooth is different from the previous one. Therefore, these calculations must be rerun for new uncut chip thickness. This process is repeated iteratively for every tooth generation in the roughing step until the uncut chip thickness and the cutting force coefficients converge to a constant value.

In order to accomplish intermediate teeth generation at all steps of the broaching process, the areas which were removed in previous teeth must be considered for uncut chip thickness and cutting force calculations. Therefore, uncut chip thickness and cutting depth in cutting force calculations must be changed to the cutting area and the length of the cutting edge. Cutting force equations for the broaching process are as follows:

$$F_t^i = K_{tc}^i A^i + K_{te} L^i \quad (3-3)$$

where F_t^i is tangential cutting force, K_{tc}^i is tangential cutting force coefficient; L^i is the length of the i^{th} tooth; K_{te} is tangential edge force coefficient and A^i is the difference between the i^{th} and $i-1^{\text{th}}$ tooth area, respectively.

3.2.2.1 Leveling of cutting forces

Intermediate teeth generation by considering constant cutting forces during the roughing and semi-finishing steps is the main aim of this study. Moreover, cutting forces at each step are determined by the user as inputs. As demonstrated earlier first roughing tooth dimension must be imported to the algorithm as an input. Next, tooth dimension is calculated by solving quadratic Eq.(3-4) by using MATLAB®.

$$F_t^n = K_{tc} \times [(a + 2dx) \times (b + dy) - (a \times b)] + K_{te} [(a + 2dx) + 2(b + dy)] \quad (3-4)$$

where a and b are the first tooth height and width, dx and dy are differences between the last and first tooth dimensions (see Figure 3-10). K_{tc} is tangential cutting force coefficients and K_{te} is tangential force coefficients.

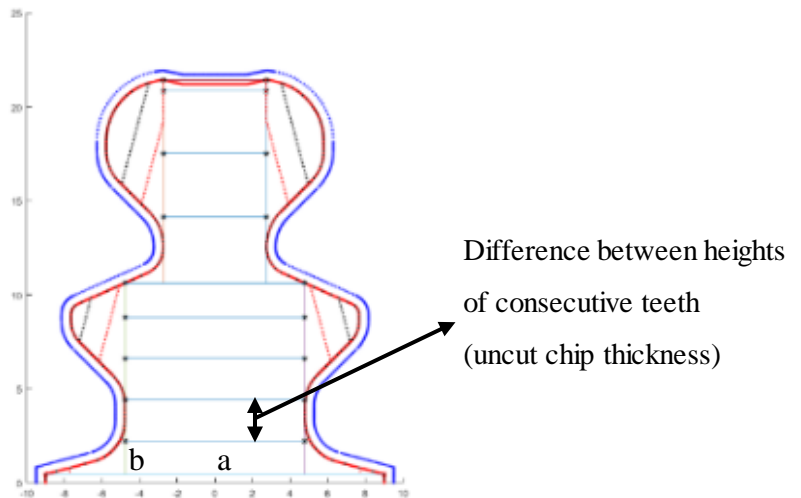

Figure 3-10 First teeth dimensions and uncut chip thickness at roughing step.

This equation can be generalized for every tooth in the roughing step as follows:

$$F_t^n = K_{tc}^n \times \left[\left(a + 2 \sum_1^{n-1} dx + 2dx \right) \times \left(b + \sum_1^{n-1} dy + dy \right) - \left(a + 2 \sum_1^{n-1} dx \right) \times \left(b + \sum_1^{n-1} dy \right) \right] + K_{te}^n \times \left[\left(a + 2 \sum_1^{n-1} dx + 2dx \right) + 2 \times \left(b + \sum_1^{n-1} dy + dy \right) \right] \quad (3-5)$$

Solving these equations leads to calculation of intermediate teeth dimensions. Teeth generation continues until reaching the boundary points. In addition, intermediate teeth differ in their height only if the width of the boundary tooth and the first tooth are the same (see Figure 3-10). If the width of boundary tooth is greater than the first tooth width, enlargement proceeds in both directions.

The cutting forces applied on the roughing teeth of the broach, which are generated by this algorithm is constant. Thus, this algorithm eliminates potential problems such as reduced tool life and chipping, tooth breakage and poor surface quality. By maximizing the cutting forces in the roughing step, the length of the broaching tool is also minimized.

The overall algorithm for intermediate roughing teeth generation is as follows:

1. Calculating critical points by using the last offset curve of the finishing tooth
2. Generating boundary points, which are the biggest roughing tooth in each zone on the offsets' finishing curves
3. Calculating cutting force coefficients by using the orthogonal database and transferring them to oblique cutting conditions for the Ti₆Al₄V alloy
4. Determining uncut chip thickness by Iterative calculation
5. Intermediate teeth generation in each roughing zone until reaching boundary points

The chart of intermediate teeth generation at roughing step is as follows:

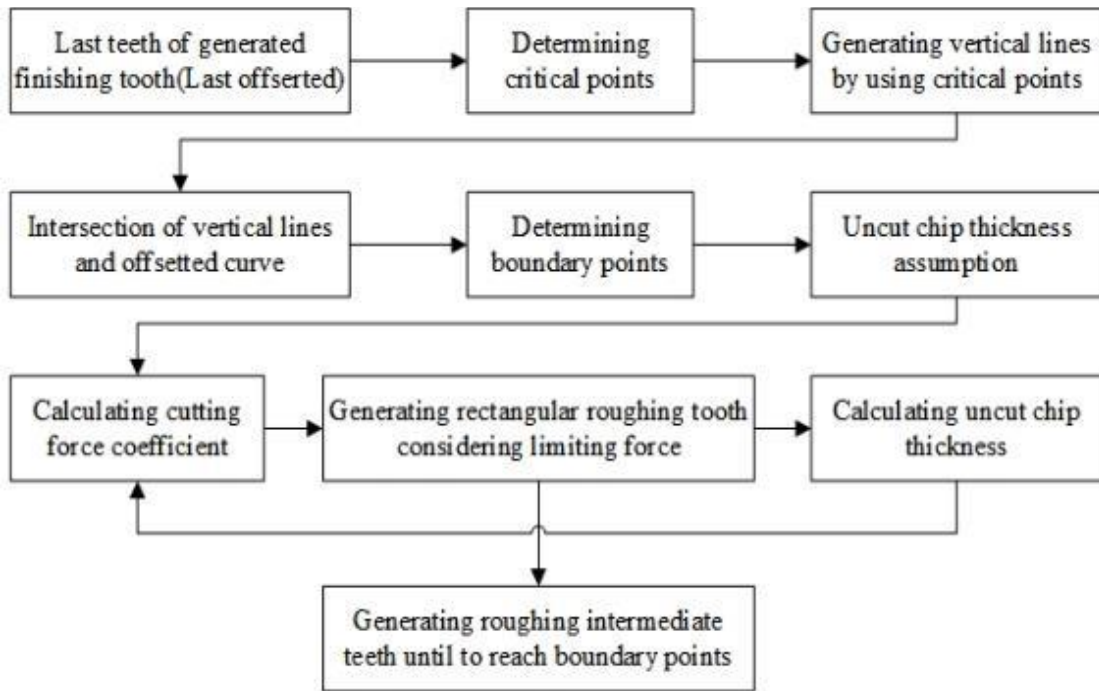

Figure 3-11 Simulation algorithm for generating the intermediate roughing teeth.

3.2.3 Semi-finishing intermediate teeth generation

The last step of intermediate teeth generation in broaching tools is semi-finishing. In order to accomplish intermediate teeth generation at the semi-finishing step, approach angle and the cutting forces in this step must be imported to the algorithm as inputs. Approach angle is the angle between the cutting edge of the semi-finishing intermediate tooth and the roughing teeth vertical side (see Figure 3-12).

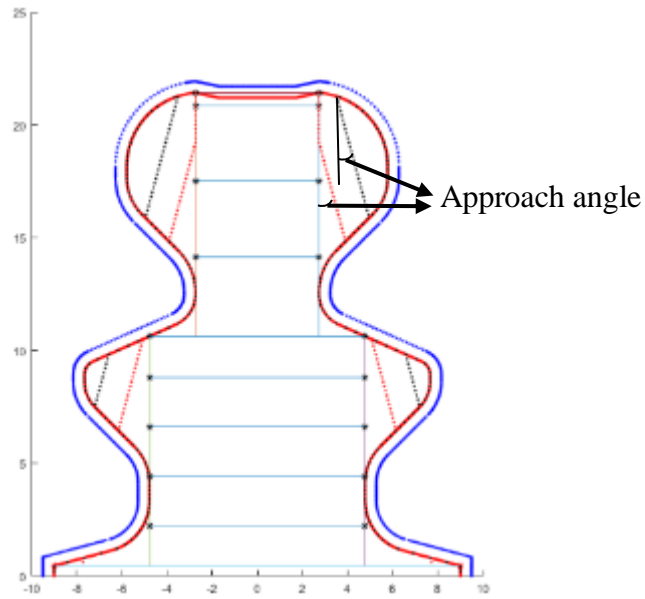

Figure 3-12 Approach angle at semi-finishing step.

Like roughing intermediate teeth generation, cutting force calculation is the first step for generating semi-finishing teeth as well. Determining cutting force coefficients by defining rake and oblique angle is the first step in cutting force calculation. As demonstrated in the previous section Eq.(3-1) and Eq.(3-2) are used in order to determine rake and inclination angle.

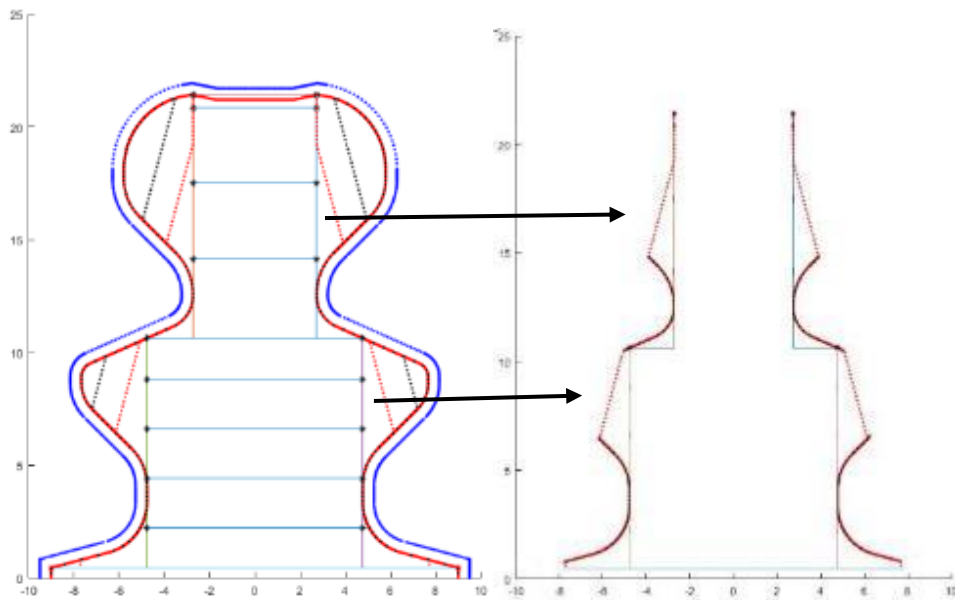

Figure 3-13 First semi-finishing teeth and cutting edges.

Cutting force coefficients are not constant along the semi-finishing intermediate teeth because of their curvy shape, as illustrated in Figure 3-13. Therefore, uncut chip thickness area must be divided along their height to the elements so that cutting coefficients and forces could be calculated precisely. Cutting force that is applied on each tooth can be calculated by using the summation of each element's forces (see Eq.(3-7)). In addition, cutting force for each element is calculated by area and the length of the cutting edge (see Eq.(3-6)).

$$f_t^j = K_{tc}^j \times A + K_{te}^j \times L \quad (3-6)$$

$$F_t = \sum_1^n f_t^j \quad (3-7)$$

where f_t^j is the tangential forces; K_{tc}^j is the cutting force coefficient in the tangential direction; A is the machined area; L is cutting edge length for each element along the height of semi-finishing teeth; F_t is the summation of cutting forces for each element in the tangential direction.

In order to generate semi-finishing teeth, the bisection method is applied [40]. In this iterative approach, an interval is defined between min and max values of the final shape in x direction ($[x_{min}, x_{max}]$). At each step, the method divides the interval into two subintervals by computing the midpoint. In the first step, the cutting force of the first intermediate semi-finishing tooth is calculated by considering the semi-finishing approach angle and midpoint. The cutting force for first semi-finishing tooth is calculated between first generated tooth and roughing tooth. This method selects the first subinterval (between the minimum point and midpoint) if the cutting force is greater than the desired cutting force for the semi-finishing region. Otherwise, the second subinterval (between midpoint and the maximum point) is selected. The process continue until the calculated force is equal to the desired force. For the next teeth generation, the cutting force is calculated between the generated teeth and the previous one.

At the semi-finishing step, similar to roughing, teeth number can be minimized by maximizing cutting forces. In addition, the number of teeth can be minimized by determining optimized approach angle in the semi-finishing region, which varies from

zero to 45 degrees. The minimum number of teeth can be defined from Figure 4-20, which illustrates the number of teeth with different approach angles.

The overall algorithm for intermediate semi-finishing teeth generation is as follows:

1. Dividing each semi-finishing tooth along its height into elements
2. Rake and inclination angle calculation for each element
3. Cutting force calculation for each element
4. Calculating cutting forces by summing up all elements' cutting forces
5. Generating semi-finishing teeth with the bisection method by considering desired cutting forces
6. Teeth generation until reducing first generated finishing intermediate tooth

The chart of intermediate teeth generation at semi-finishing step is as follow:

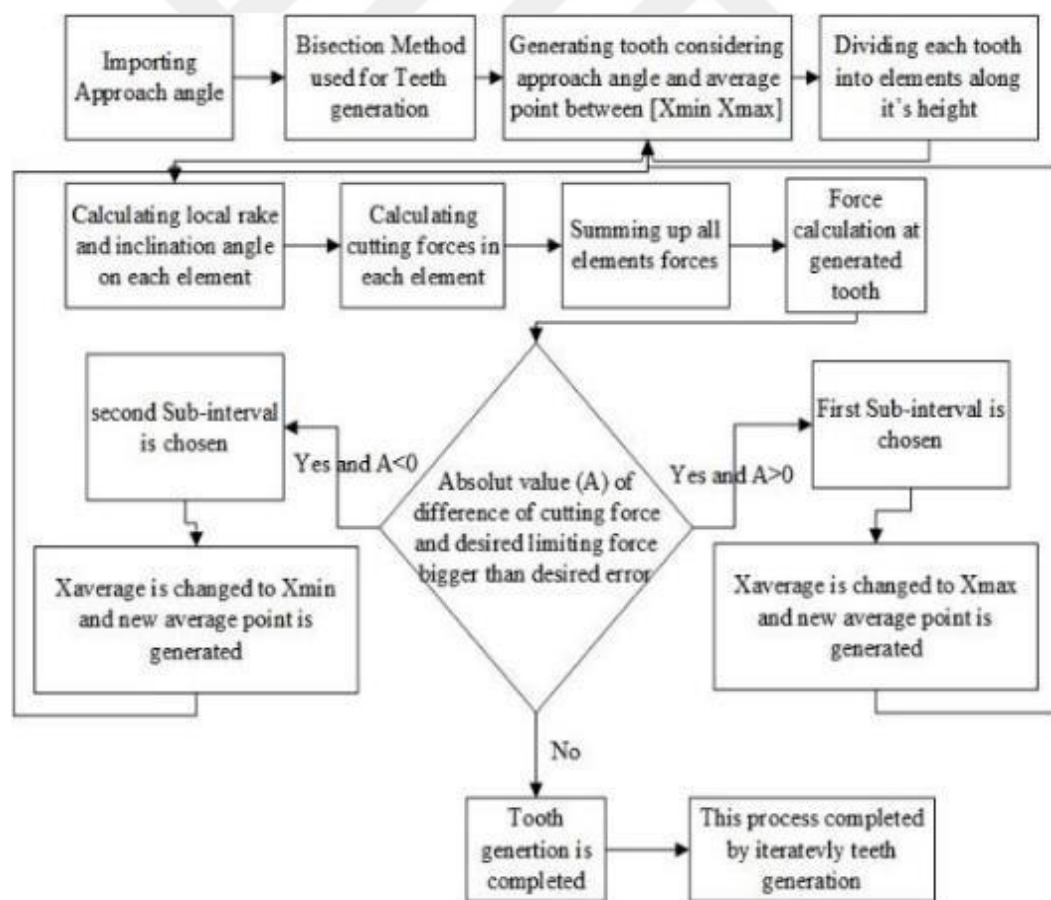

Figure 3-14 Simulation algorithm for generating the semi-finishing intermediate teeth

Chapter 4. SIMULATION AND DISCUSSION

The outputs of developed algorithm is the intermediate teeth generation by leveling cutting forces. This algorithm can be used for the optimized teeth generation of complicated broaching tools or simple ones. Various rake, inclination and approach angle can be imported to the algorithm to get various teeth number at the roughing or semi-finishing step. Optimized values for the angles can be selected with comparison of the teeth number in each simulation. In this section various rake, inclination and approach angle and different cutting forces are used for the intermediate teeth generation. The final tooth shape, which was used in these simulations, is fir-tree slot used in turbine disks. As mentioned in previous chapter the simulations and automatic teeth generations are conducted by the developed approach for broaching of the Ti₆Al₄V alloy. Ti₆Al₄V alloy orthogonal database (Table 3-1) was used and transformed to oblique cutting conditions in these simulations.

4.1 Analysis on cutting forces

The intermediate teeth generation can be accomplished by considering various cutting forces during the roughing and semi-finishing step. Limiting cutting forces can be selected as equal or non-equal in the roughing and semi-finishing step. in the first simulation set the limiting cutting force is selected to be 20,000 *N*, the rake and inclination angles are set to zero and approach angle for semi-finishing is 15°. The resulting

automatic teeth generation can be found in Figure 4-1 and the tangential cutting force acting on each tooth can be seen in Figure 4-2.

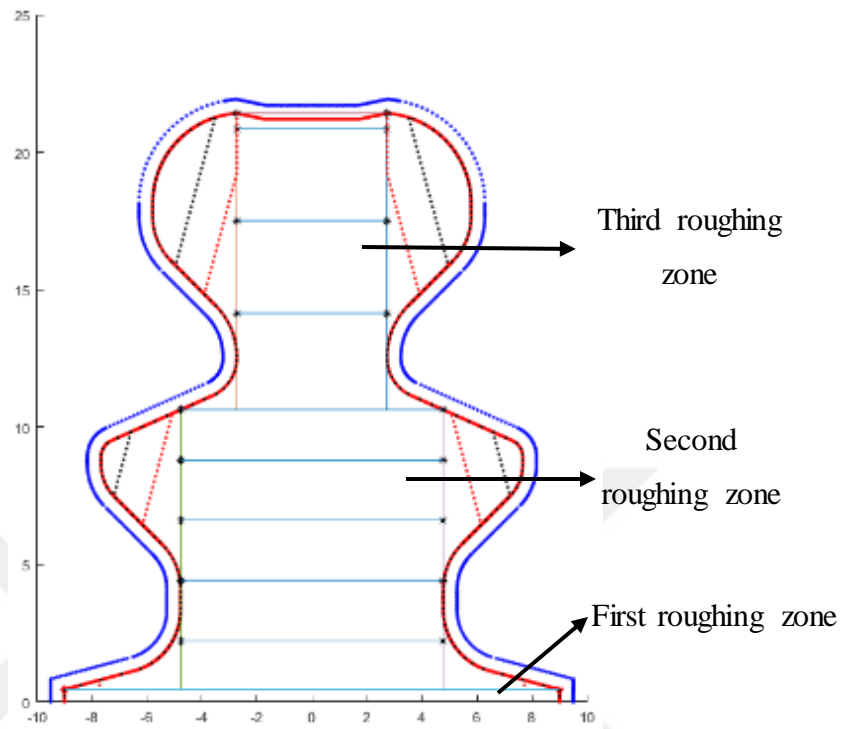

Figure 4-1 Broaching teeth simulation: Limiting cutting force in roughing and semi-finishing is 20,000 N, rake and inclination angles are set to zero, approach angle is selected as 15°.

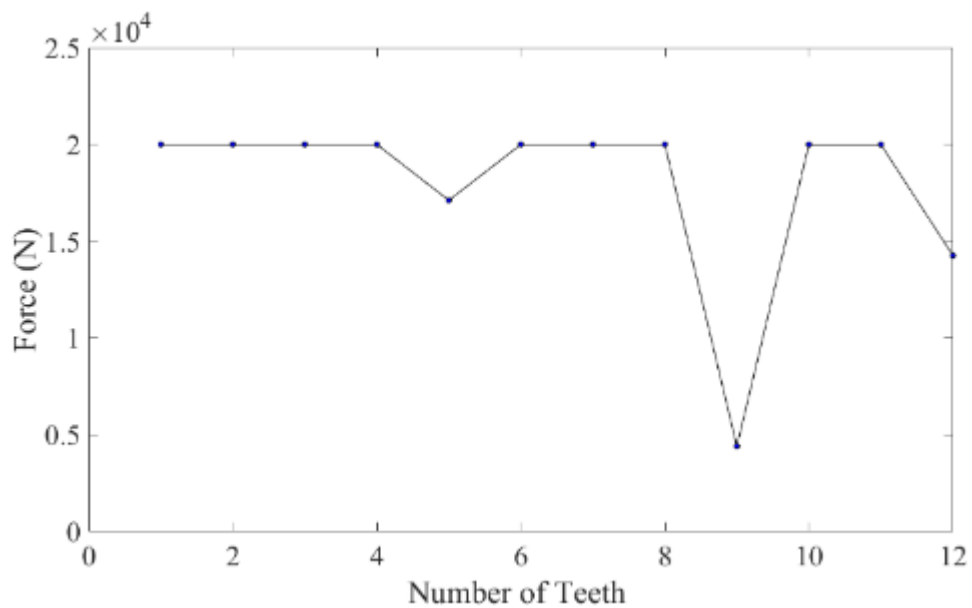

Figure 4-2 Tangential cutting forces acting on each tooth.

In all simulations because of the broaching tool shape used in these simulations there are three boundary points. Therefore, three roughing zones are generated in these simulations. All three roughing zones generated with different uncut chip thicknesses. First roughing zone has the smallest uncut chip thickness because of the first boundary point position and third roughing zone generated with the largest uncut chip thickness. The third roughing zone has bigger uncut chip thickness because the width of roughing teeth in this region is smaller than second roughing zone. This is occurred to keep cutting forces constant during roughing operation (Figure 4-1).

In the second simulation set, roughing and semi-finishing cutting forces are changed to 10000 (N). Rake and inclination angle are set to zero and approach angle is selected as 15° as similar to the previous simulation. The simulation results can be seen in Figure 4-3 and Figure 4-4.

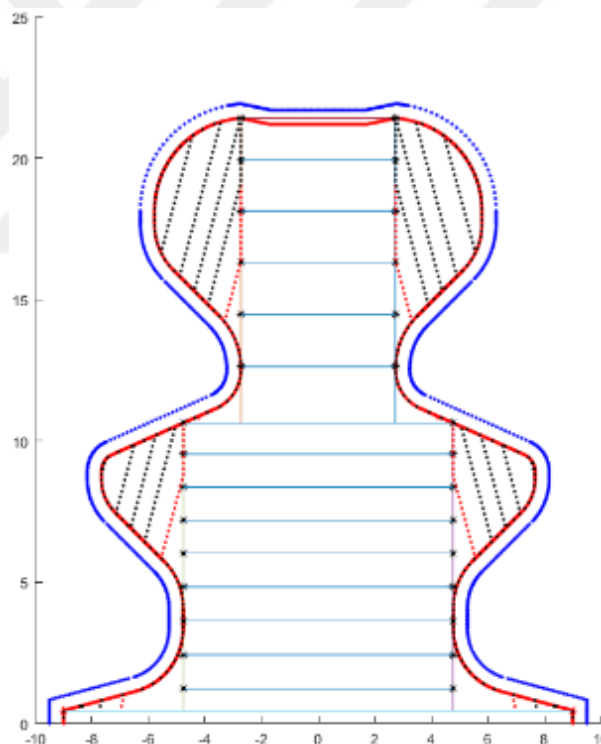

Figure 4-3 Broaching teeth simulation: Limiting cutting force in roughing and semi-finishing is selected as 10,000 N, rake and inclination angle is set to zero, approach angle is 15° .

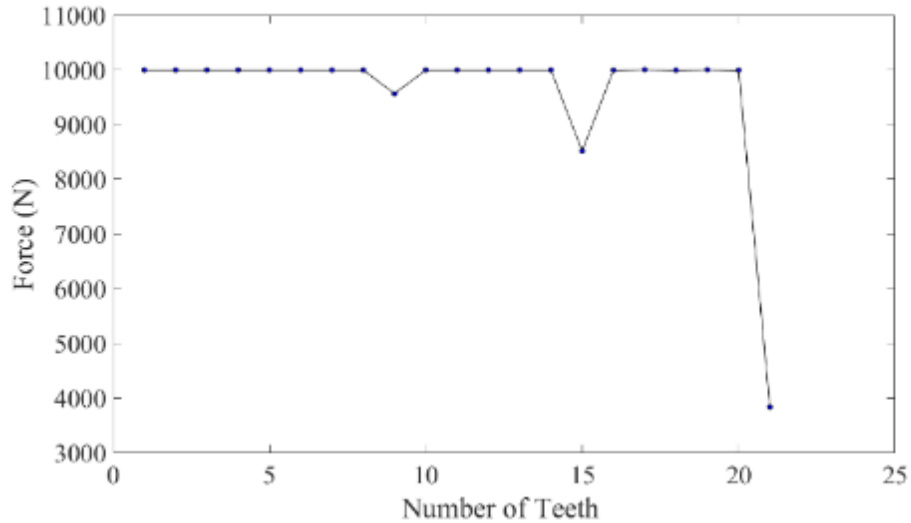

Figure 4-4 Tangential cutting forces acting on each tooth.

Comparison of first (Figure 4-2) and second simulation (Figure 4-3) illustrates that by decreasing limiting cutting forces, uncut chip thickness at both roughing and semi-finishing steps is decreased as well. Therefore, teeth number increased at both roughing and semi-finishing steps.

In the third simulation set, roughing and semi-finishing limiting cutting force is changed to 2,000 N. Rake, inclination are set to zero and approach angle is selected as 15°. Figure 4-5 and Figure 4-6 illustrate this simulation.

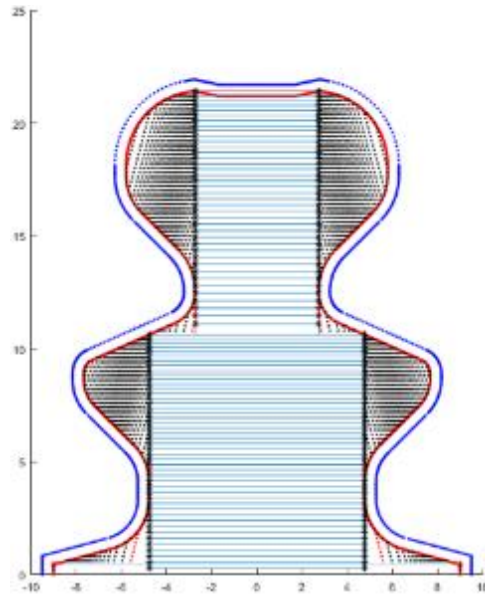

Figure 4-5 Broaching teeth simulation: Limiting cutting force in roughing and semi-finishing is selected as 2,000 N, rake and inclination angle is set to zero, approach angle is selected as 15°.

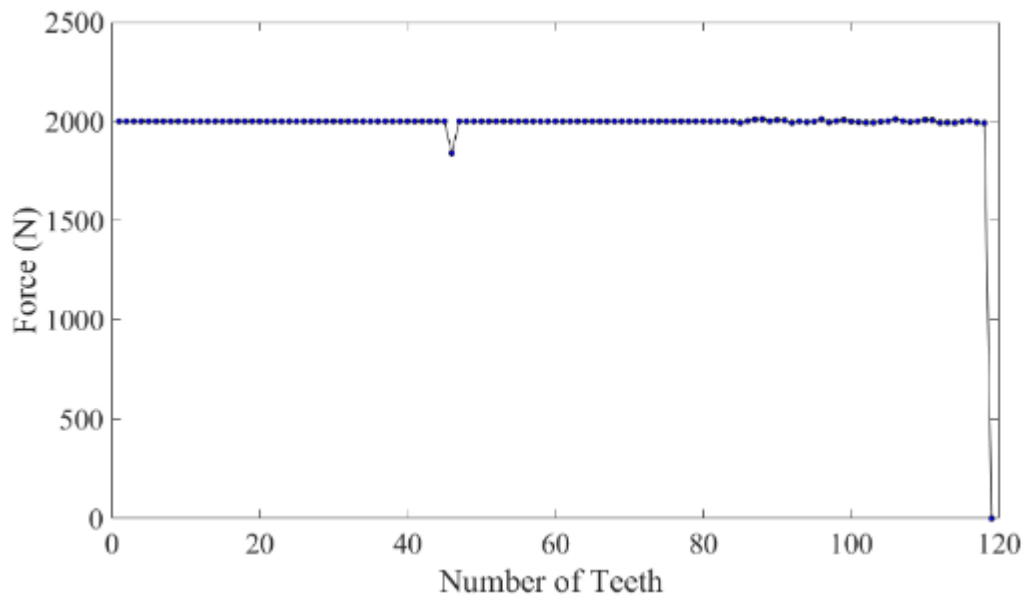

Figure 4-6 Tangential cutting forces acting on each tooth.

In this simulation, uncut chip thickness at both roughing and semi-finishing is smaller than the previous simulations because of smaller limiting forces in comparison of the previous ones. As it can be resulted from this simulation the limiting force at the roughing and semi-finishing could not be smaller than the edge forces. In these cases, algorithm could not be able to generate the intermediate teeth because of edge force.

As demonstrated before, various cutting forces can be selected at the roughing and semi-finishing step. In this simulation, limiting cutting force at roughing step is determined as 5,000 N and for semi-finishing step is 2,000 N. As previous simulations, rake and inclination angle are set to zero and approach angle in semi-finishing region is 15°. Figure 4-7 shows the results and calculated tangential cutting forces acting on each tooth can be seen in Figure 4-8.

The semi-finishing teeth are manufactured with more details in comparison with the roughing teeth in broaching tools. Therefore, the semi-finishing teeth include some details in which the teeth are not so strong, and these details are weaker than the roughing teeth, which are generally, have rectangular shape. Therefore, manufacturing the parts with lower semi-finishing limiting force in comparison with the roughing limiting force prevent semi-finishing teeth from breakage or chipped edge and it increase the broach tool life.

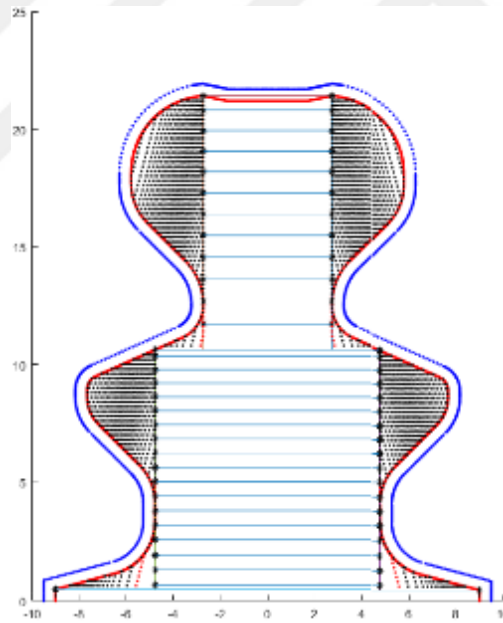

Figure 4-7 Roughing cutting force is 5,000 N and semi-finishing cutting force is 2,000 N.

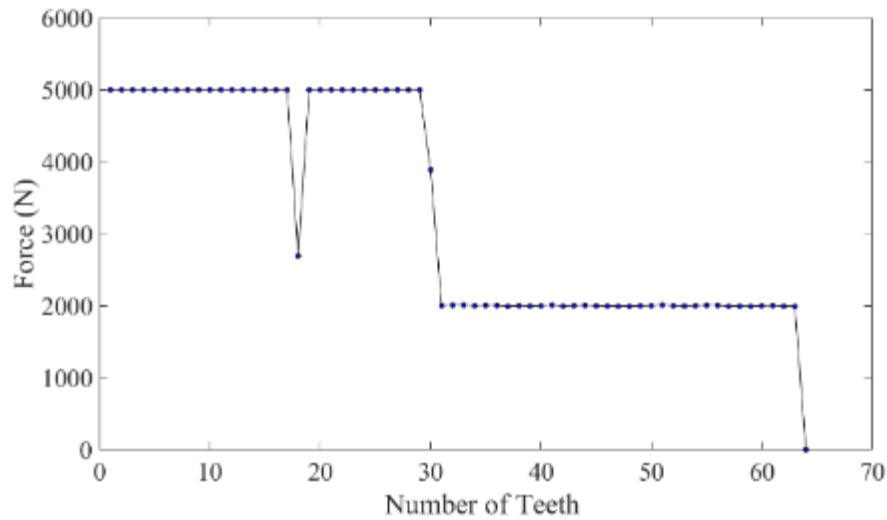

Figure 4-8 Tangential cutting forces acting on each tooth.

As mentioned in previous sub-section cutting forces at roughing and semi-finishing step can be same or different from each other. By investigating the result of simulation with various limiting cutting forces, there is a huge change in teeth number with changing limiting cutting forces at the roughing and semi-finishing steps. Thus, by maximizing cutting forces that applied on each tooth in roughing or semi-finishing tooth, teeth number can be minimized and therefore tooth length and cost of the broach are minimized as well. The effect of cutting forces on the teeth number at both roughing and semi-finishing steps are illustrated in Figure 4-9. (In all cases, rake and inclination angle is zero and approach angle is 15°)

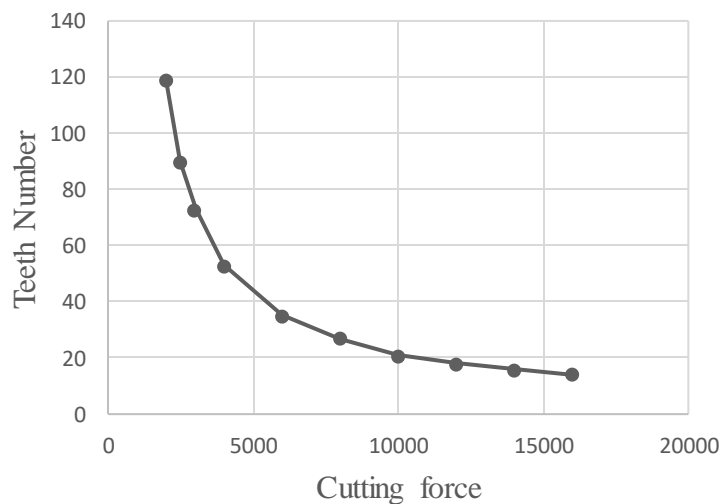

Figure 4-9 Cutting force vs Teeth number.

4.2 Analysis on rake and inclination angles

Broaching tools similar to the tools used for the other machining processes are manufactured with various rake and inclination angles. In this chapter, proposed algorithm is used for simulation of intermediate teeth generation with various rake and inclinations angle and effects are investigated by considering number of teeth and broach tool length. The cutting force at the roughing and semi-finishing step, which was used for all these simulations, determined as 2,000 N. The rake angle is set to zero, 15° and 30° and inclination angle is defined as zero. The simulation results with these inputs can be found in Figure 4-10, Figure 4-11 and Figure 4-12.

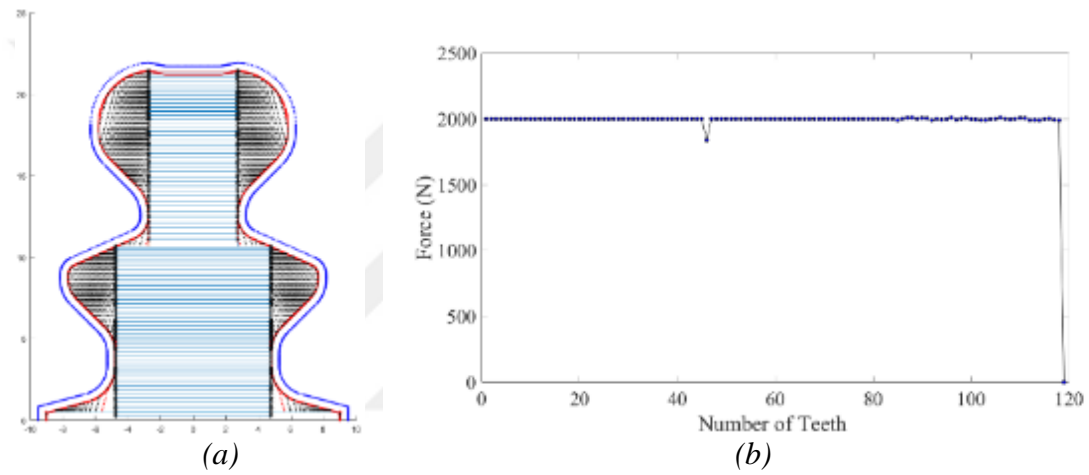

Figure 4-10 Rake and inclination angle is set to zero a) teeth shape
b) tangential cutting force on each tooth.

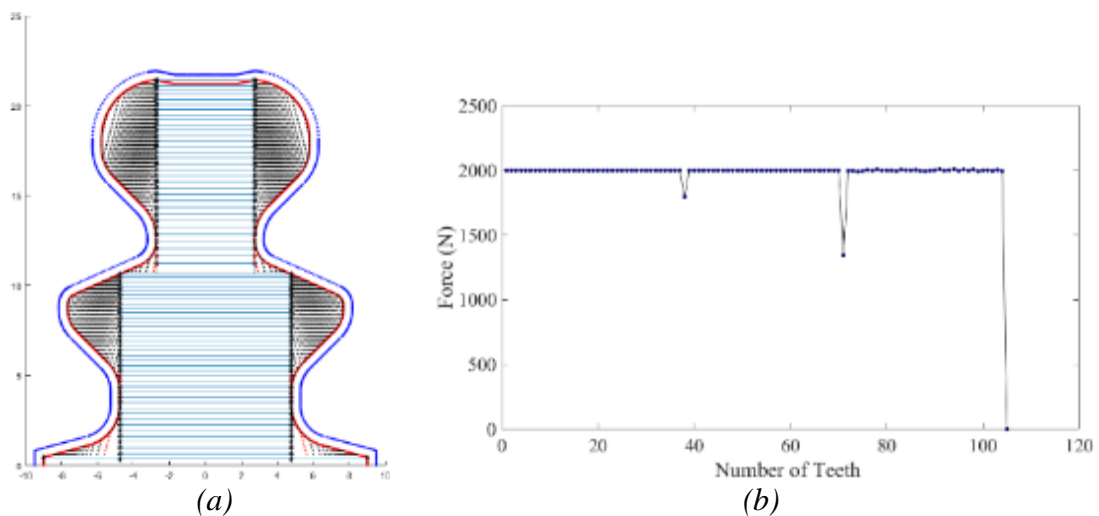

Figure 4-11 Rake angle is 15° and inclination angle is set to zero a) teeth shape
b) cutting force on each tooth.

By comparing these two simulations in which only rake angle is changed it could be resulted that rake angle is one of the significant parameters in broaching tool design. Teeth number is changed by only changing rake angle where limiting cutting force at roughing and semi-finishing step is not changed in these simulations.

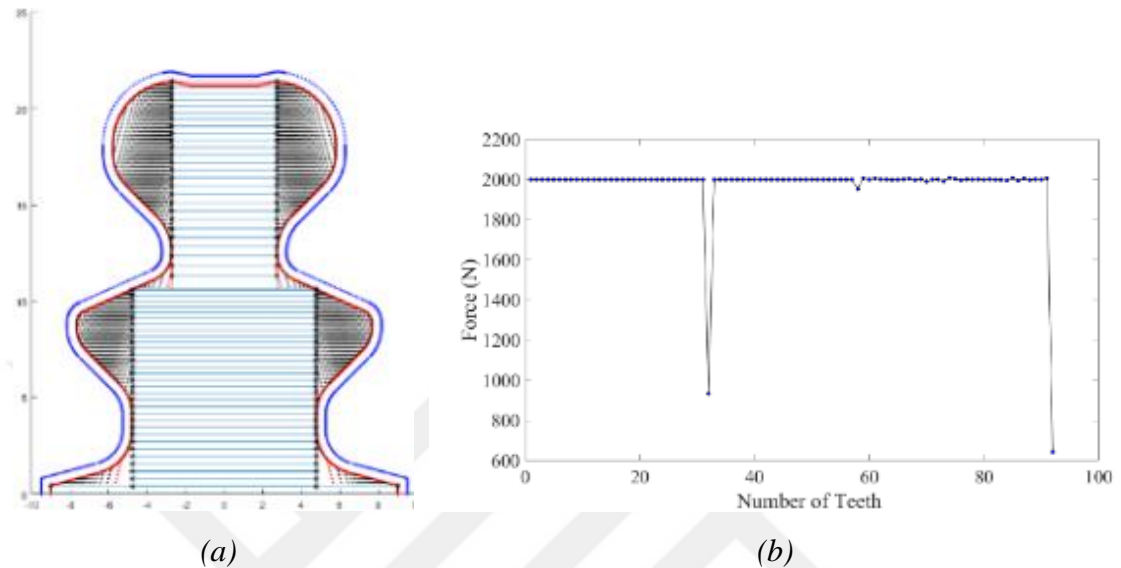

Figure 4-12 Rake angle is 30° and inclination angle is set to zero a)teeth shape
b)tangential cutting force on each tooth.

In this simulation rake angle is set to 30° and as expected, the teeth number is decreased because of increasing the rake angle. By increasing rake angle cutting force is decreased therefore the uncut chip area must be increased to keep cutting force constant and by increasing uncut chip area the number of tooth is decreased.

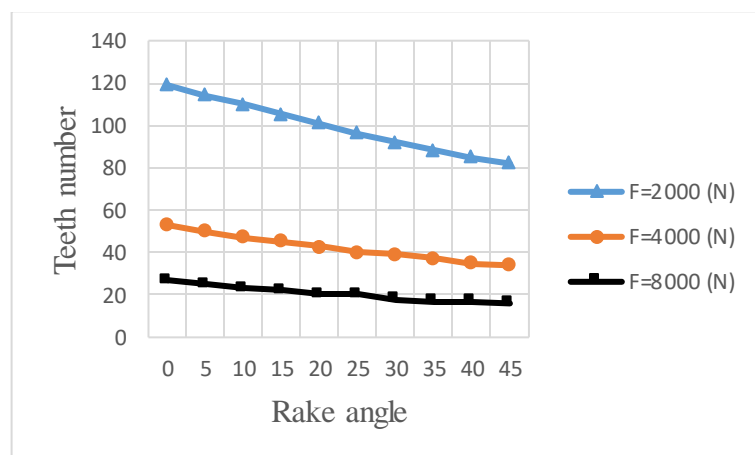
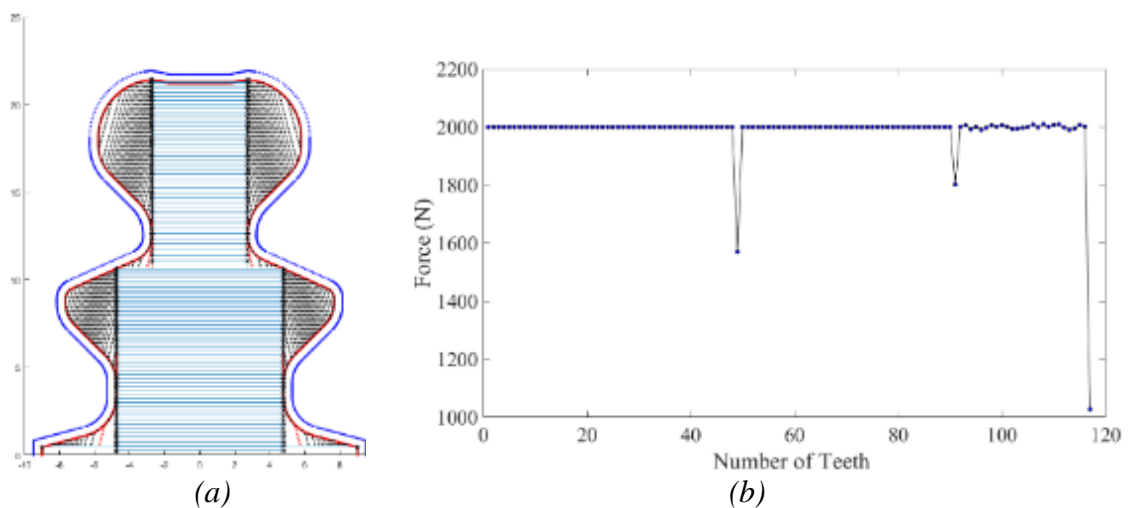

Figure 4-13 Rake angle vs Teeth number.

Figure 4-13 shows the relation of rake angle with teeth number. The inclination angle in these simulations are set to zero. Figure 4-13 illustrates that, teeth number is decreased by increasing rake angle in broaching teeth. As discussed before rake angle is one of the most significant parameters in machining. This is due to the fact that, changing rake angle effects the contact area between tool and chip. By increasing rake angle the cutting force is decreased therefore, by increasing rake angle the number of teeth is decreased. This effect is much more important in the tools with lower limiting cutting forces due to the fact that in this tool uncut chip are is small and rake angle has more effect in the tooth number reduction.

By maximizing rake angle, teeth number is minimized. On the contrary, broaching teeth are weakened by increasing the rake angle. Therefore, optimized rake angle must be used for manufacturing of broaching teeth to prevent them from various problems such as chipped edge or broken tooth.

In addition, the effect of inclination angle on broaching teeth number at both roughing and semi-finishing step are investigated. In these simulations inclination angle is selected as 15° and 30° ; rake angle is assumed as zero and approach angle is 15° as previous simulations. These results of the simulations are illustrated in Figure 4-14 and Figure 4-15.



*Figure 4-14 Inclination angle is 15° and Rake angle is zero: a)teeth shape
b)tangential cutting force on each tooth.*

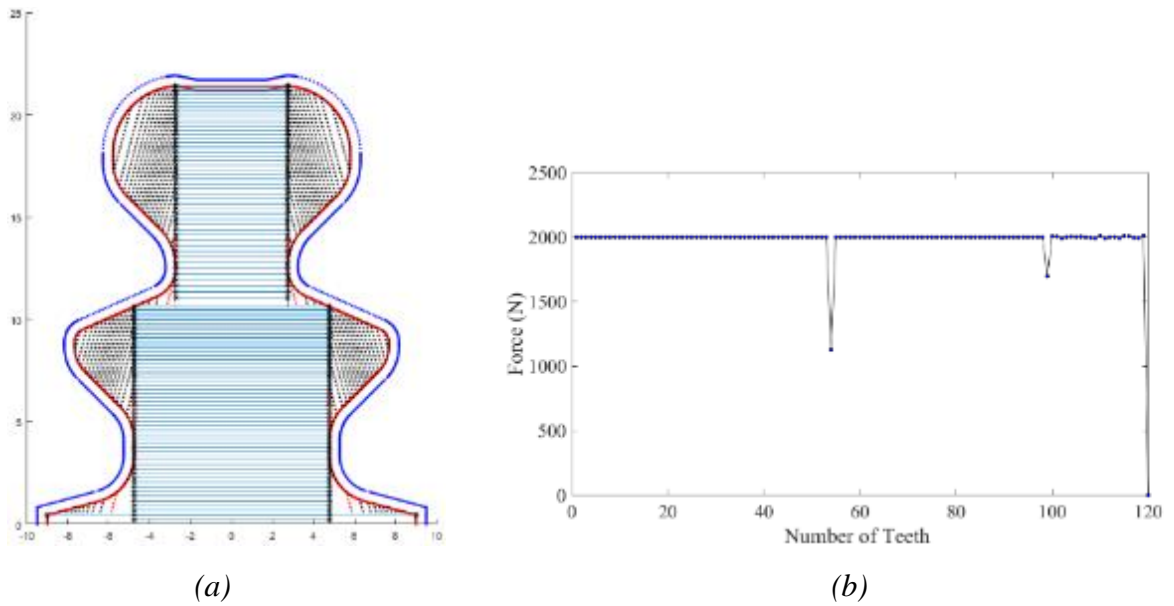

Figure 4-15 Inclination angle is 30° and Rake angle is zero: a)teeth shape
 b)tangential cutting force on each tooth.

These two simulations in which only inclination angle is changed illustrate that inclination angle does not have significant effect on teeth number. In addition inclination angle play a significant role in radial cutting forces and in this study due to the symmetric shape of broaching tools, radial cutting forces eliminate each other and inclination angle does not have much effect on the tangential force. Figure 4-16 illustrates relations of various inclination angle and teeth number in simulated broaching tool. As a consequent with the current simulation model inclination angle has no effect on teeth number of the broaching tools.

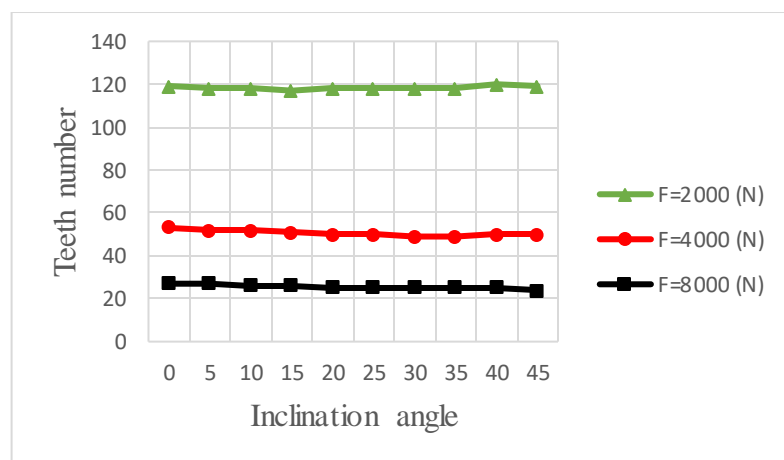

Figure 4-16 Inclination angle vs Teeth number.

4.3 Analysis on the approach angle at the semi-finishing step

Intermediate teeth at the semi-finishing step can be generated with various approach angles. Different approach angles with constant cutting force for teeth generation are resulted different teeth number for semi-finishing step. Thus, optimized approach angle selection for teeth generation at semi-finishing step is resulted in shortening of broaching tool and lower cost of broaches. Therefore, the cost of broaching tool manufacturing can be reduced with appropriate selection of rake, inclination and approach angle without changing cutting forces. The cost of broaching tools can be optimized by maximizing cutting forces, optimized rake, inclination angle and approach angle. Three simulations are run for three different values of approach angle which are, 5° , 15° and 30° at the semi-finishing step. These simulations are accomplished by 4,000 N as the limiting cutting force, where rake and inclination angles are set to zero. The results can be seen in Figure 4-17, Figure 4-18 and Figure 4-19.

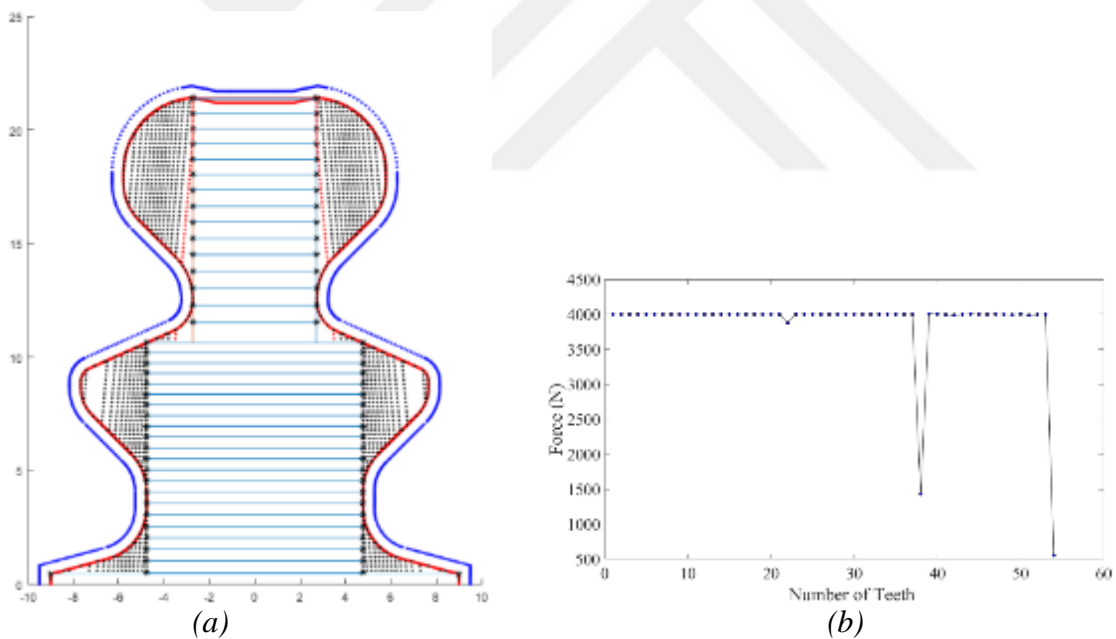

Figure 4-17 approach angle is 5° : a) teeth shape b) tangential cutting force on each tooth.

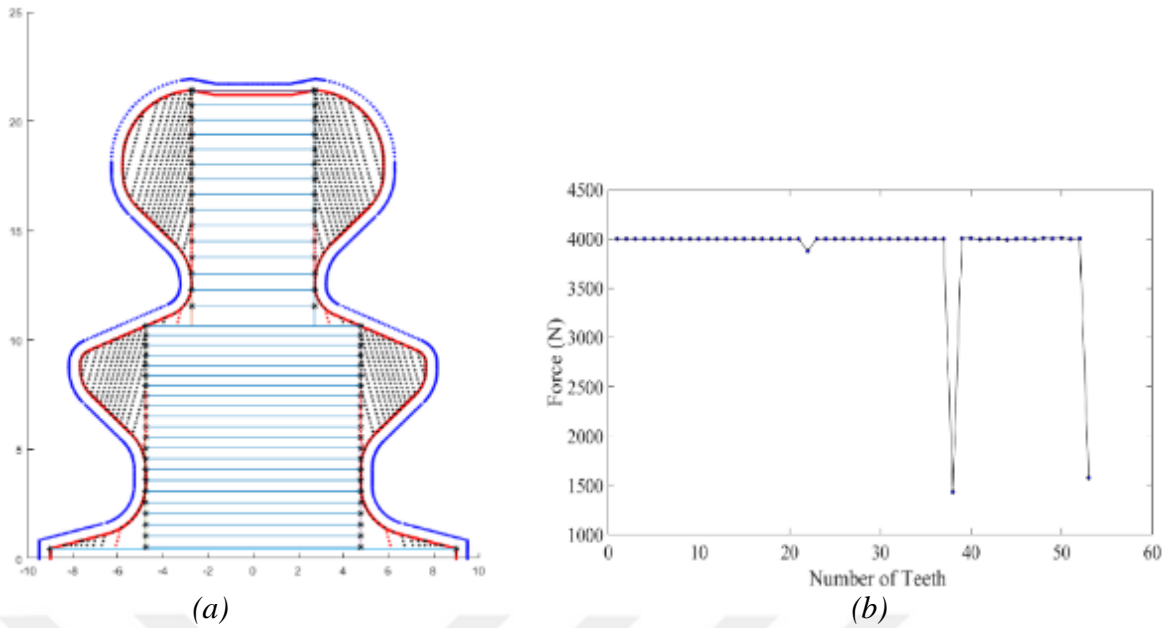

Figure 4-18 Approach angle is 15° : a) teeth shape b) tangential cutting force on each tooth.

Comparison of Figure 4-17 and Figure 4-18 illustrate that there is not so much difference in calculated teeth number in these two cases. The relation of approach angle with the teeth number must be investigated for all shapes of broaching tools individually. Since the last tooth shape and the limiting cutting force in the semi-finishing region have significant roles on the number of teeth.

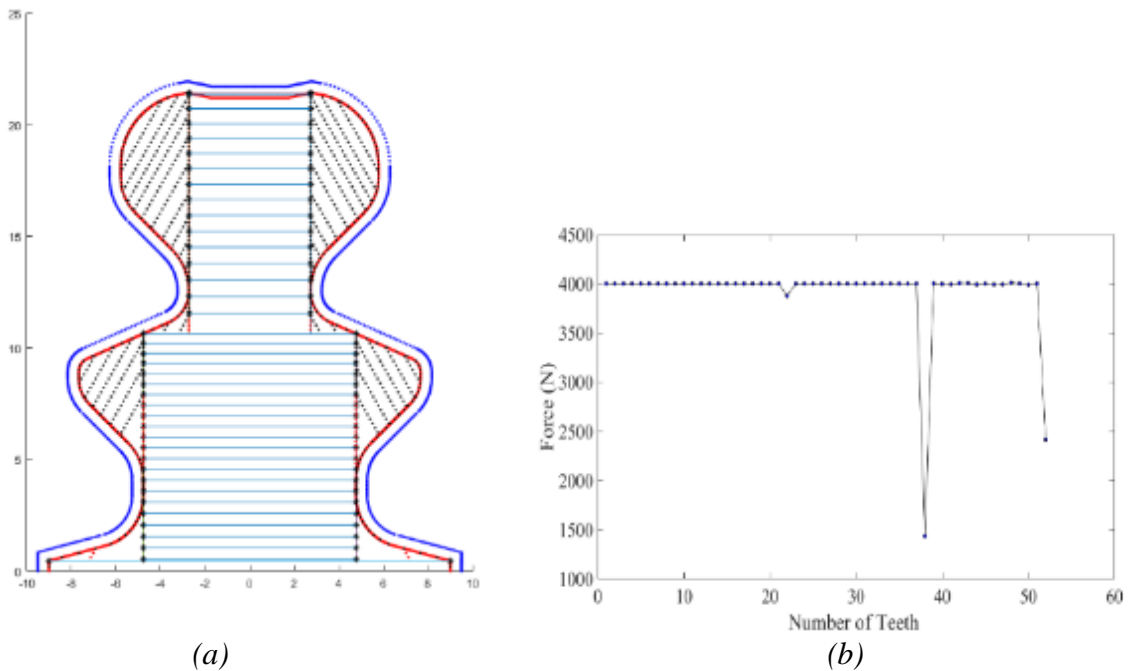

Figure 4-19 Approach angle is 30° : a) teeth shape b) tangential cutting force on each tooth.

Semi-finishing teeth number and approach angle relations are illustrated in Figure 4-20. In all these simulations, rake and inclination angles are set to zero. As discussed in previous chapters, approach angle is the critical parameter for generating intermediate teeth at semi-finishing step and it has no effect on roughing teeth generation. Thus, for getting best result, the effect of approach angle on semi-finishing teeth number is investigated instead of all broaching teeth number.

As can be observed from the Figure 4-20 semi-finishing teeth number is decreased by increasing approach angle. However, increasing approach angle has more effect on the broaching tools in which semi-finishing intermediate teeth generation is accomplished by lower cutting forces. This behavior cannot be generalized for every broaching tool because this behavior is due to the shape of fir-tree slots. Since the edges of the fir-tree have decreasing area, the elements that are generated at the tips are very much affected from the approach angle. Higher approach angle values result in lower edge forces because of lower cutting-edge length and therefore higher uncut chip areas in order to keep the broaching forces constant during semi-finishing step. Therefore, the developed algorithm determines the optimum value for the approach angle in various simulations for different broaching tools.

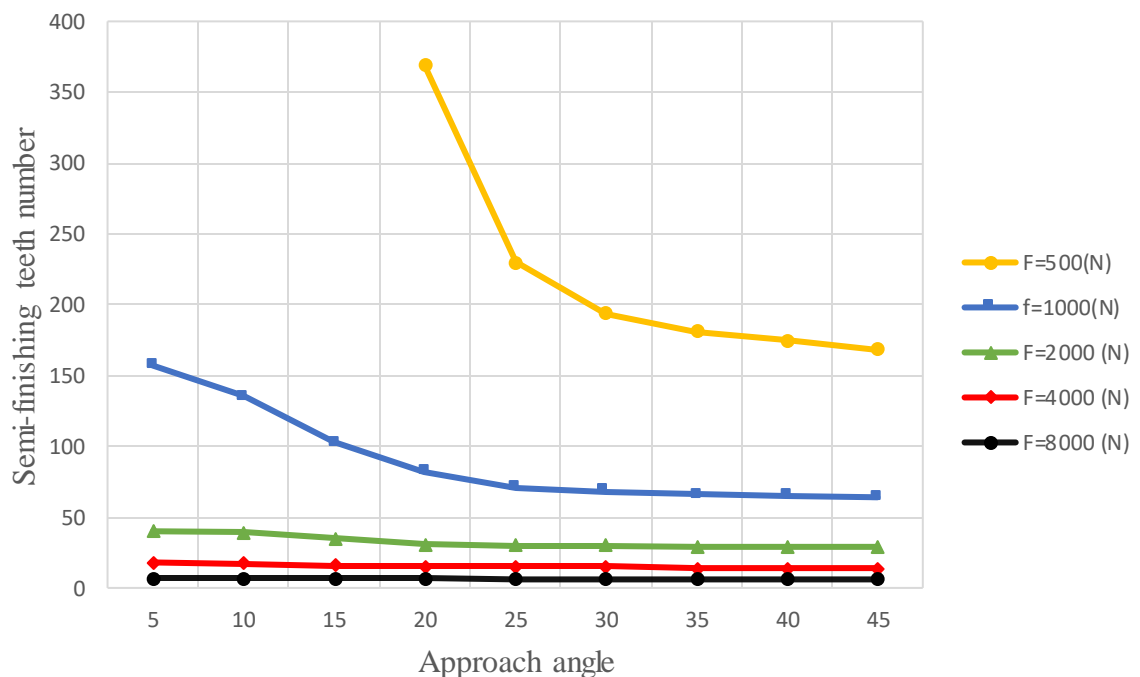

Figure 4-20 Approach angle vs Semi-finishing teeth number.

Furthermore, as it can also be seen from Figure 4-20 that, approach angle has more effect on the number of teeth at lower limiting forces. This is expected as the effect of the edge forces are more significant at lower limiting force values. Therefore, the uncut chip thickness area and teeth number at semi-finishing step are drastically affected at lower limiting forces. Moreover, at lower approach angles, the edge force is more than desired limiting force due to increase of cutting edge length. In these cases, the algorithm could not find feasible uncut chip thickness and intermediate teeth generation were not accomplished. Consequently, approach angle is one the most significant parameters at tool-designing step especially for the tools which designed with lower cutting force in semi-finishing process.

By applying this algorithm at broaching tool-designing step, optimized approach angle can be chosen before manufacturing broaches and it reduced cost of each tool and the entire broaching operation.

4.4 Cutting forces at the intersection of regions

Investigating all simulations, which accomplished with various parameters such as roughing and semi-finishing limiting forces, rake, inclination and approach angle are resulted that, there are some teeth, which are generated with lower cutting forces than desired limiting forces. These teeth are at the border of each region (i.e. at the intersection of roughing and semi-finishing). At roughing step, these teeth reach to the boundary points and resulted teeth with cutting forces lower than limiting forces for roughing step. This is also occurred in semi-finishing region. The smallest tooth that generated with offsetting of last tooth shape is boundary curve for semi-finishing step. Therefore, the last tooth of semi-finishing step is generated with lower cutting forces than desired force for this region. Consequently, generating tooth with lower cutting force is happened when tooth generated at boundary of each region such as roughing and semi-finishing.

Chapter 5. CONCLUSIONS

Broaching tools are used for machining high quality parts with tight tolerances. Because all processes such as roughing, semi-finishing and finishing is accomplished with one strike in broaching operations. Broaching operations are done by pushing or pulling broaches through the work piece in order to machine desired shapes and this operation only completed by linear motion. Due to nature of this process, cutting speed is the only parameter that can be changed during machining. Although, depth of cut and feed rate are the other significant parameters, which can be changed, in the other machining process, in the broaching operations they embedded in tool design and they cannot be changed after tool design step and during machining. Therefore, optimized tool design before manufacturing step is one of the most significant steps in broaching operation.

Leveling cutting forces in tool design step is the other important issue in broaching tool design. Constant cutting forces during each step in broaching operation can eliminate problems such as broken, chipped tooth and poor surface quality.

In this thesis, an approach for automatic intermediate teeth generation of broaching tools by leveling cutting forces at roughing and semi-finishing step is presented. The developed algorithm is used for simulation of various cases with different parameters such as roughing and semi-finishing limiting forces, rake, inclination and approach angles. The desired shape, which is machined on the workpiece, is imported to the algorithm as an input. Fir-tree slot is used as desired shape for the final tooth for all simulations in this study. Ti₆Al₄V alloy orthogonal database was used for tool and workpiece couple and it

was transformed to the oblique cutting condition in order to predict cutting forces. Tangential cutting force is used for cutting force calculations since the radial cutting force is eliminated due to symmetry of broaching tools. The feed force, on the other hand, also eliminated since its effect is mostly at the root of broach tooth.

In this study, various simulations are presented. Teeth number for broaching tools are illustrated for these simulations. By comparison of various simulations optimized broaching tools parameters can be resulted. Therefore, the methods developed in this study is one more step ahead from the previous studies as it involves automatic generation of intermediate teeth in broaches by changing only a few parameters. The solution time of the developed algorithm depends on the parameters and for moderate simulation case it is around 2 minutes.

As a conclusion, following are results of this thesis:

1. An automated broach tool design algorithm is developed which also takes the cutting mechanic and broaching forces into account.
2. Various parameters can be imported to the developed algorithm such as any last tooth shape, roughing and semi-finishing limiting forces, rake, inclination and approach angles.
3. It is shown one more time that teeth number or broaching tool length can be minimized by maximizing cutting forces.
4. It can be deduced that teeth number or broaching tool length can be minimized by maximizing rake angle and rake angle has more effect on tools which are generated with lower cutting forces while broaching Ti alloys.
5. With the given orthogonal data, it is shown that inclination angle does not have much effect on the number of teeth.
6. One of the original contribution of this study is to show that approach angle has an important effect on the number of teeth at semi-finishing step. Increasing approach angle decreases number of teeth.
7. Edge forces play a significant role in teeth generation at semi-finishing step. Especially the simulations with lower limiting cutting forces (i.e.

having lower uncut chip thickness values) are more vulnerable to this effect.

5.1 Original contributions

Intermediate teeth generation for broaching tools has been previously studied in a few works without considering cutting forces. However, this research for the first time emphasized the intermediate teeth generation by leveling cutting forces in all roughing, semi-finishing and finishing steps of broaching operation. By leveling cutting forces in the broaching tool design potential problems such as chipped tooth, broken tooth and poor surface quality can be eliminated. Eliminating these problems can reduce tool cost and as a result total cost of broaching tool is decreased since, the most significant parameter in the broaching operation is tool cost.

The other contribution of this study is investigation of the approach angle effect in the semi-finishing teeth number. As discussed before increasing approach angle in these simulations decreased the number of teeth at the semi-finishing step. However, this relation between approach angle and the number of teeth cannot be generalized for all broaching tools since, the teeth number are effected so much with the semi-finishing tooth shapes and the cutting force in this region. For obtaining optimum approach angle for different broaching tools, the developed algorithm must be applied and the optimized approach angle can be calculated with the approach which is developed in this study.

5.1.1 Comparison between real and simulated broach tool

In order to compare between real broach tool which designed by tool manufacturer and simulated broach tool with this algorithm, the last tooth shape of this tool is imported to the algorithm and the intermediate teeth generation is accomplished by applying this automatic algorithm. The real broach tool simulation is done by BOSS[®] software. The output of the BOSS[®] software for predicting of cutting forces is in three direction. F_z

correspond tangential cutting forces. The cutting forces on each tooth which are simulated by BOSS® application is illustrated in Figure 5-1 that demonstrates that cutting force values can be fluctuate between 200 and 3000 N. This fluctuation can cause various problems such as chipped tooth, tooth breakage and poor surface quality.

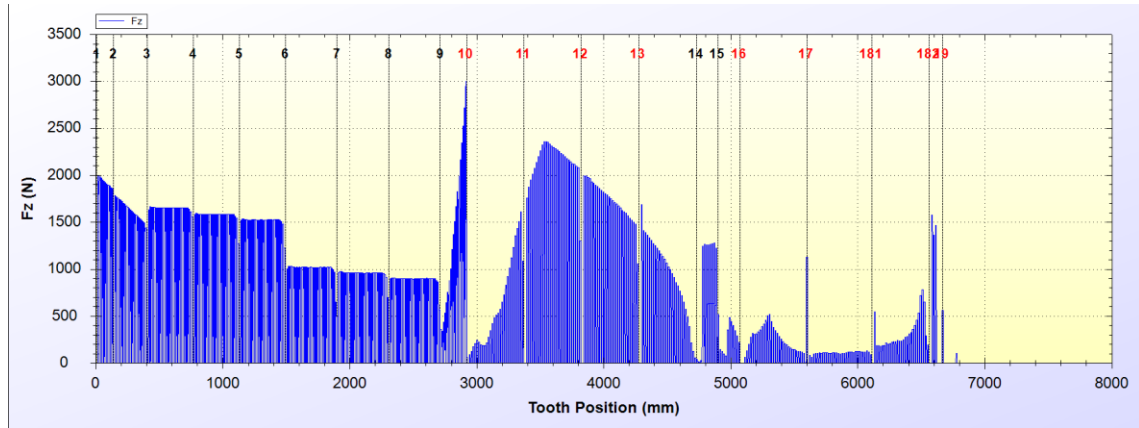

Figure 5-1 tangential cutting forces of real broach tool that simulated with BOSS®.

The teeth number for this tool is 591 and the length of this tool is 6500 mm without applying optimization. As mentioned before the shape of this tool imported to the developed algorithm and simulation is accomplished and limiting force at the roughing and semi-finishing steps is set to 1000 N which is almost average of cutting forces resulted from BOSS® application.

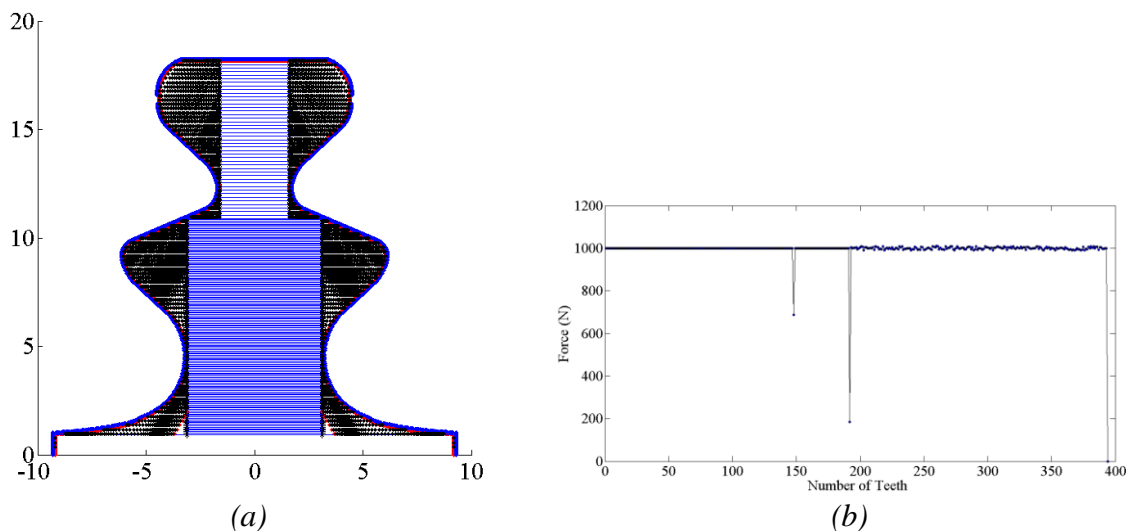

Figure 5-2 Simulation with developed algorithm. Limiting force at roughing and semi-finishing is set to 1000 N. rake and inclination angle is set to zero and approach angle is 25°
a) teeth shape b) tangential cutting force on each tooth.

The number of teeth can be decreased by increasing rake and approach angle. Figure 5-3 illustrates variation of the teeth number with rake and approach angle. The teeth number can be decreased by increasing rake and approach angle. However, as mentioned before by increasing rake angle, the tooth edge is weakened. Therefore, optimum value must be selected for rake angle. For instance by choosing 15° as rake angle and selecting 30° for approach angle, the teeth number can be decreased up to 310. By assuming 15 mm for the pitch value the total length of broach tool can be decreased to 4650 mm which is 6650 mm for the real broach tool without any optimization.

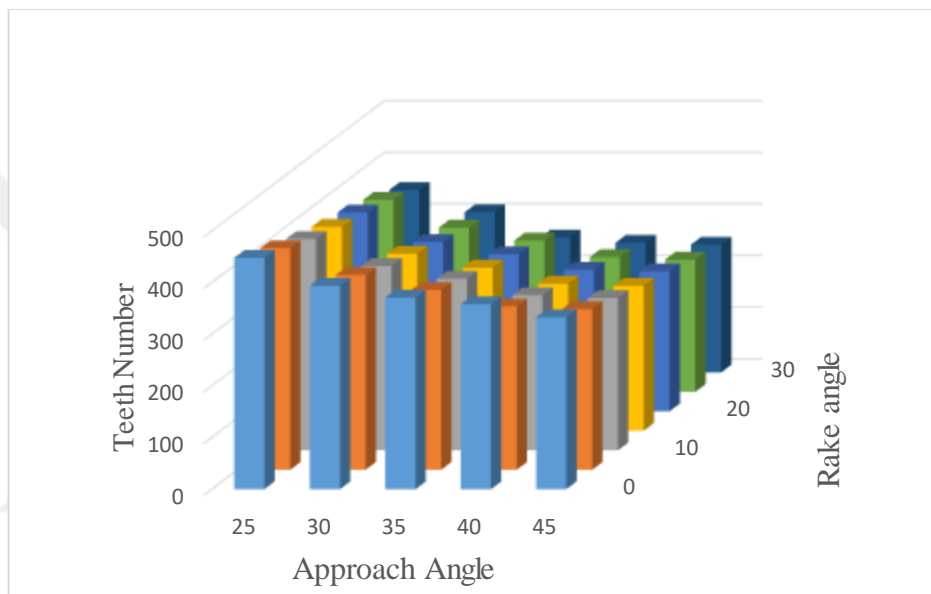

Figure 5-3 Teeth number Vs Rake and Approach angle

5.2 Pre-machining

In order to decrease the teeth number and total broach length the roughing operation of broaching process can be replaced by pre-machining process. For instance, in order to manufacturing the part with the tool which mentioned in the previous sub-section, milling operation can accomplish the desired part roughing step and broaching tool can be used for remaining semi-finishing and finishing step. The desired shape can be manufactured by broaching tool with 391 tooth. However, If pre-machining operation which is accomplished by milling operation added to this process, the roughing step of broaching

tool can be eliminated and as a result the teeth number can be decreased to 207. Figure 5-4 shows pre-machined and the steps which is machined by broach tool for semi-finishing and finishing processes.

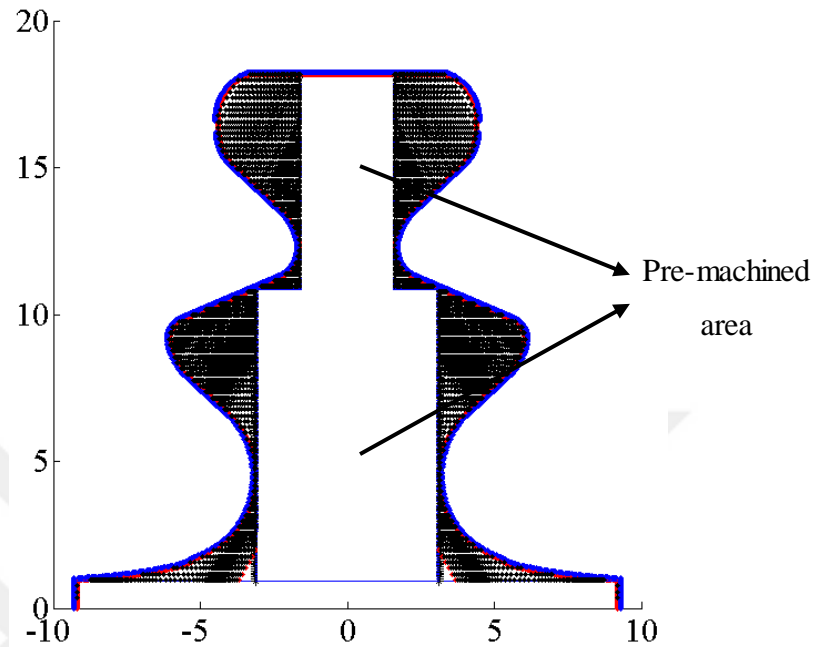

Figure 5-4 Pre-machined area for eliminating roughing step in broach tool.

5.3 Recommendation for future research

The future research works in this area can be focused on the following items:

- Within the scope of this study, the rectangular shape is used at the roughing step for generating the intermediate roughing teeth. In future works, various shapes can be used for generating the roughing teeth and selecting optimized shape at the roughing teeth generation step can be added to this algorithm in the future works. Various constraints can be added to this algorithm in order to determining the optimized shape for this step.
- In the future studies different models can be used for predicting cutting force such as third deformation zone model [41]. During machining operation the contact between the cutting edge and the work material cause third deformation zone and

it resulted edge forces. As discussed above edge forces has significant effect on cutting forces where uncut chip thickness has small value. Therefore thermomechanical modeling of third deformation zone can be used for predicting cutting forces.

- In future works the pitch can be added to the algorithm as a variable. Constant and variable pitch can be used for cutting parameters' optimization. Further studies can obtain pitch optimization procedure in the algorithm. This optimization can reduce the whole tool length.
- Simulation of this algorithm for whole parameters and then selecting optimized values for each parameters are so time consuming. Therefore, genetic algorithm can be applied to this method for selecting optimized tool design parameters such as pitch, rake, inclination and approach angle.

REFERENCES

1. Monday, C., *Broaching*. 1960: Machinery Publishing Company.
2. Kokmeyer, E.W. and S.o.M. Engineers, *Better Broaching Operations*. 1984: Society of Manufacturing Engineers.
3. Bangalore, H.M.T., *Production Technology* 1980: TATA Mcgraw-Hill. 875.
4. Hamm, S., et al., *Broaching, planing, shaping and slotting*. Tool and Manufacturing Engineers Handbook, 1983. 1.
5. Terry, W.R. and K. Cutright, *Computer aided design of a broaching process*. Computers & industrial engineering, 1986. **11**(1-4): p. 576-580.
6. Gilormini, P., et al., *A comparative analysis of three machining processes: broaching, tapping and slotting*. CIRP Annals-Manufacturing Technology, 1984. **33**(1): p. 19-22.
7. Budak, E. *Broaching process monitoring*. in *Proceeding of Third International Conference on Metal Cutting and High Speed Machining, Metz, France*. 2001.
8. Axinte, D.A. and N. Gindy, *Tool condition monitoring in broaching*. Wear, 2003. **254**(3): p. 370-382.
9. Axinte, D., et al., *Broaching of Ti-6-4—Detection of workpiece surface anomalies on dovetail slots through process monitoring*. CIRP Annals-Manufacturing Technology, 2005. **54**(1): p. 87-90.
10. Vijayaraghavan, L., R. Krishnamurthy, and H. Chandrasekaran, *Evaluation of stress and displacement of tool and workpiece on broaching*. International Journal of Machine Tool Design and Research, 1981. **21**(3-4): p. 263-270.
11. Sajeev, V., L. Vijayaraghavan, and U. Rao, *An analysis of the effects of burnishing in internal broaching*. International Journal of Mechanical Engineering Education, 2000. **28**(2): p. 163-173.
12. Sutherland, J., E. Salisbury, and F. Hoge, *A model for the cutting force system in the gear broaching process*. International Journal of Machine Tools and Manufacture, 1997. **37**(10): p. 1409-1421.
13. Ozturk, O. and E. Budak. *Modeling of broaching process for improved tool design*. in *International Mechanical Engineering Congress and Exposition, Washington, DC*. 2003.

14. Kokturk, U. and E. Budak, *Optimization of broaching tool design*. Proceeding of the CIRP ICME, 2004. **4**.
15. Hosseini, A. and H. Kishawy, *B-spline based general force model for broaching*. Trans. North Am. Manuf. Res. Inst. SME, 2010. **38**: p. 9-15.
16. Hosseini, A. and H. Kishawy, *Prediction of cutting forces in broaching operation*. Journal of Advanced Manufacturing Systems, 2013. **12**(01): p. 1-14.
17. Hosseini, A. and H. Kishawy, *On the Optimized Design of Broaching Tools*. Journal of Manufacturing Science and Engineering, 2014. **136**(1): p. 011011.
18. Hosseini, A. and H.A. Kishawy, *Parametric simulation of tool and workpiece interaction in broaching operation*. International Journal of Manufacturing Research, 2013. **8**(4): p. 422-442.
19. Ozelkan, E.C., O. Ozturk, and E. Budak, *Identifying parameters of a broaching design using non-linear optimisation*. International Journal of Modelling, Identification and Control, 2011. **12**(3): p. 244-252.
20. Mo, S., et al., *An example of selection of the cutting conditions in broaching of heat-resistant alloys based on cutting forces, surface roughness and tool wear*. Journal of materials processing technology, 2005. **160**(3): p. 382-389.
21. Axinte, D., *An experimental analysis of damped coupled vibrations in broaching*. International Journal of Machine Tools and Manufacture, 2007. **47**(14): p. 2182-2188.
22. Vogtel, P., et al., *Automatic Broaching Tool Design by Technological and Geometrical Optimization*. Procedia CIRP, 2015. **33**: p. 496-501.
23. Hosseini, S.A., *Model based simulation of broaching operation: cutting mechanics, surface integrity, and process optimization*. 2013.
24. Özlü, E., et al., *Simulation of broaching operations for tool design optimization*. 2010.
25. Altintas, Y., *Manufacturing automation: metal cutting mechanics, machine tool vibrations, and CNC design*. 2012: Cambridge university press.
26. Özlü, E., *Analytical modeling of cutting process mechanics and dynamics for simulation of industrial machining operations*. 2008.
27. Merchant, M.E., *Mechanics of the metal cutting process. II. Plasticity conditions in orthogonal cutting*. Journal of applied physics, 1945. **16**(6): p. 318-324.
28. Lee, E., *The theory of plasticity applied to a problem of machining*. J. App. Mech., 1951. **73**: p. 405.

29. Palmer, W. and P. Oxley, *Mechanics of orthogonal machining*. Proceedings of the Institution of Mechanical Engineers, 1959. **173**(1): p. 623-654.
30. Armarego, E.J.A. and R.H. Brown, *The machining of metals*. 1969: Prentice-Hall.
31. Merchant, M.E., *Basic mechanics of the metal-cutting process*. ASME J. of Applied Mechanics, 1944. **11**: p. A168.
32. BU, J.K., *Betriebswissenschaftliche Arbeiten*. VDI Verlag, 1939. **12**.
33. Stabler, G., *The chip flow law and its consequences*. Advances in Machine Tool Design and Research, 1964. **5**: p. 243-251.
34. Merchant, M.E., *Mechanics of the metal cutting process. I. Orthogonal cutting and a type 2 chip*. Journal of applied physics, 1945. **16**(5): p. 267-275.
35. Armarego, E. and R. Whitfield, *Computer based modelling of popular machining operations for force and power prediction*. CIRP Annals-Manufacturing Technology, 1985. **34**(1): p. 65-69.
36. El-Hofy, H.A.-G., *Fundamentals of machining processes: conventional and nonconventional processes*. 2013: CRC press.
37. Budak, E., Y. Altintas, and E. Armarego, *Prediction of milling force coefficients from orthogonal cutting data*. Journal of Manufacturing Science and Engineering, 1996. **118**(2): p. 216-224.
38. Choi, B.K. and S.C. Park, *A pair-wise offset algorithm for 2D point-sequence curve*. Computer-Aided Design, 1999. **31**(12): p. 735-745.
39. Liu, X.-Z., et al, *An offset algorithm for polyline curves*. Computers in Industry, 2007. **58**(3): p. 240-254.
40. Traub, J.F., *Iterative methods for the solution of equations*. Vol. 312. 1982: American Mathematical Soc.
41. Budak, E., et al, *Thermo-mechanical modeling of the third deformation zone in machining for prediction of cutting forces*. CIRP Annals, 2016. **65**(1): p. 121-124.