

V. K. AYDIN

IZMIR KATIP CELEBI UNIVERSITY

2018

**IZMIR KATIP CELEBI UNIVERSITY  
GRADUATE SCHOOL OF NATURAL AND APPLIED SCIENCES**

**ANTITUMOR EFFECT OF RGD PEPTIDE ON CANCER MICROTISSUES**



**M.Sc. THESIS**

**Veli Kaan AYDIN**

**Department Biomedical Technologies Programme**

**OCTOBER 2018**

**IZMIR KATIP CELEBI UNIVERSITY  
GRADUATE SCHOOL OF NATURAL AND APPLIED SCIENCES**

**ANTITUMOR EFFECT OF RGD PEPTIDE ON CANCER MICROTISSUES**



**M.Sc. THESIS**

**Veli Kaan AYDIN  
(Y160204002)**

**Department of Biomedical Technologies Programme**

**Thesis Advisor: Assist. Prof. Ozan KARAMAN**

**OCTOBER 2018**

**İZMİR KATİP ÇELEBİ ÜNİVERSİTESİ**  
**FEN BİLİMLERİ ENSTİTÜSÜ**

**RGD PEPTİDİN KANSER MİKRODOKULARI ÜZERİNDE ANTİTÜMÖR**  
**ETKİSİ**

**YÜKSEK LİSANS**

**Veli Kaan AYDIN**  
**(Y160204002)**

**Biyomedikal Teknolojileri Ana Bilim Dalı**

**Tez Danışmanı: Dr. Öğr. Üyesi Ozan KARAMAN**

**EKİM 2018**

Veli Kaan AYDIN a M.Sc. student of IKCU Graduate School Of Natural And Applied Sciences, successfully defended the thesis entitled “ANTITUMOR EFFECT OF RGD PEPTIDE ON CANCER MICROTISSUES”, which he/she prepared after fulfilling the requirements specified in the associated legislations, before the jury whose signatures are below.

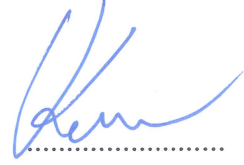
**Thesis Advisor :**

**Assist. Prof. Dr. Ozan KARAMAN**  
İzmir Katip Çelebi University



**Jury Members :**

**Assist. Prof. Dr. Utku Kürşat ERCAN**  
İzmir Katip Çelebi University



**Prof. Dr. Bahattin TANYOLAÇ**  
Ege University



**Date of Submission : 11.09.2018**  
**Date of Defense : 05.10.2018**



*To my family,*

## **FOREWORD**

Foremost, I would like to say thanks to my advisor Assist. Prof. Dr. Ozan KARAMAN. His wide knowledge and logical way of thinking have been of great value for me. His understanding, encouraging, personal guidance have provided a strong basis for my studies and his information is very important in especially trouble experimental analysis.

I would like to express my special thanks to my dearest laboratory friends Ziyşan Buse YARALI, Günnur ONAK and more specifically Izmir Katip Celebi University Regenerative Medicine and Tissue Engineering Laboratory for their support.

In truth, I could not have achieved my current level of success without a strong support group. I would like to thank Tuğba ÜNSEL AYDIN, my beloved wife, who is always on my side and supports me under all circumstances. I would also like to thank my wonderful family, my father Mesut AYDIN, my mother Gülay AYDIN and my brother Asrın AYDIN. They are the ones that build me to reach this day.

October 2018

Veli Kaan AYDIN

## TABLE OF CONTENTS

	<u>Page</u>
<b>FOREWORD</b> .....	<b>iii</b>
<b>TABLE OF CONTENTS</b> .....	<b>iv</b>
<b>ABBREVIATIONS</b> .....	<b>v</b>
<b>LIST OF TABLES</b> .....	<b>vi</b>
<b>LIST OF FIGURES</b> .....	<b>vii</b>
<b>ABSTRACT</b> .....	<b>viii</b>
<b>ÖZET</b> .....	<b>ix</b>
<b>1. INTRODUCTION</b> .....	<b>1</b>
1.1 Purpose of Thesis .....	1
1.2 Literature Review .....	2
1.2.1 3D systems .....	2
1.2.1.1 Scaffold based 3D cell cultures.....	3
1.2.1.2 Non-scaffold based 3D cultures.....	10
1.2.2 Model breast cancer cells .....	12
1.2.3 Biofunctional peptides .....	13
1.2.3.1 RGD (GRGDS) peptide .....	15
1.2.4 Apoptosis .....	16
1.2.4.1 Mechanisms of apoptosis .....	16
1.2.5 Antitumor effect of RGD peptides.....	18
<b>2. MATERIALS &amp; METHODS</b> .....	<b>19</b>
2.1 Peptide Synthesis .....	19
2.2 Cell Culture .....	19
2.2.1 2D cell culture .....	19
2.2.1 3D cell culture .....	20
2.3 Live & Dead Assay .....	20
2.4 Actin Cytoskeleton/Focal Adhesion Staining Kit.....	21
2.5 Analysis of Cancer Microtissue's Diameter Size.....	21
<b>3. RESULTS</b> .....	<b>22</b>
<b>4. DISCUSSION</b> .....	<b>32</b>
<b>5. CONCLUSION</b> .....	<b>37</b>
<b>REFERENCES</b> .....	<b>38</b>
<b>CURRICULUM VITAE</b> .....	<b>45</b>

## ABBREVIATIONS

<b>DMF</b>	:Dimethylformamide
<b>HBTU</b>	:N,N,N',N'-Tetramethyl-O-(1H-benzotriazol-1-yl)uronium hexafluorophosphate, O-(Benzotriazol-1-yl) N,N,N',N'-tetramethyluronium hexafluorophosphate
<b>HOBt</b>	:1-hydroxybenzotriazole
<b>DIEA</b>	:N,N-diisopropylethylamine
<b>TFA</b>	:Trifluoroacetic Acid
<b>TIPS</b>	:Triisopropylsilane
<b>PBS</b>	:Phosphate Buffer Saline
<b>FBS</b>	:Fetal Bovine Serum
<b>RGD peptide</b>	:R (Arginine), G (Glycine), D (Aspartic Acid)
<b>3D</b>	:3-Dimensional
<b>2D</b>	:2-Dimensional
<b>ECM</b>	:Extracellular Matrix
<b>PGA</b>	:Polyglycolic Acid
<b>PLA</b>	:Polylactic Acid
<b>PCL</b>	:Aliphatic Polyester Polycaprolactone
<b>POE</b>	:Poly-ortho Ester
<b>DAH</b>	:Differential Adhesion Hypothesis
<b>SPSS</b>	:Strong Stage Peptide Blend
<b>Fmoc</b>	:Fluorenylmethyloxycarbonyl chloride
<b>Bmoc</b>	:t-Butyloxycarbonyl
<b>ICAD</b>	:Inhibitor of caspase-activated deoxyribonuclease
<b>CAD</b>	:Caspase-activated deoxyribonuclease
<b>TNF</b>	:Tumor Necrosis Factor
<b>TRADD</b>	:TNF receptor-associated Death Domain
<b>FADD</b>	:Fas-associated Death Domain
<b>AIF</b>	:Apoptosis Inducing Factor
<b>LiBr</b>	:Lithium bromide
<b>BSA</b>	:Bovine Serum Albumin
<b>DAPI</b>	:4',6-Diamidino-2-Phenylindole, Dihydrochloride
<b>HPLC</b>	:High-Pressure Liquid Chromatography



## LIST OF TABLES

### Page

**Table 3.1** : Sequence, observed and calculated molecular weight of RGD peptide....**23**



## LIST OF FIGURES

	<u>Page</u>
<b>Figure 1.1</b> : Chitosan formula.....	5
<b>Figure 1.2</b> : Polyglycolic acid and Polylactic acid formula.....	8
<b>Figure 1.3</b> : Polycaprolactone formula.....	8
<b>Figure 1.4</b> : Micropatterned Surfaces.....	9
<b>Figure 1.5</b> : Hanging Drop Method.....	10
<b>Figure 1.6</b> : Microfluidic Plate.....	11
<b>Figure 1.7</b> : 3D PetriDish® Technique.....	12
<b>Figure 2.1</b> : 3D Cell Culture.....	20
<b>Figure 3.1</b> : Ionization mass spectra of RGD peptide .....	22
<b>Figure 3.2</b> : Liquid chromatography spectra of RGD peptide.....	22
<b>Figure 3.3</b> : The effect of 0 mM RGD peptides on tumor microtissue formation at 1st, 4rd and 7th days .....	23
<b>Figure 3.4</b> : The effect of 2 mM RGD peptides on tumor microtissue formation at 1st, 4rd and 7th days .....	24
<b>Figure 3.5</b> : The effect of 4 mM RGD peptides on tumor microtissue formation at 1st, 4rd and 7th days .....	24
<b>Figure 3.6</b> : The effect of 6 mM RGD peptides on tumor microtissue formation at 1st, 4rd and 7th days.....	25
<b>Figure 3.7</b> : Effect of 0 mM RGD concentration on the MCF-7 microtissue.....	25
<b>Figure 3.8</b> : Effect of 2 mM RGD concentration on the MCF-7 microtissue.....	26
<b>Figure 3.9</b> : Effect of 4 mM RGD concentration on the MCF-7 microtissue .....	26
<b>Figure 3.10</b> : Effect of 6 mM RGD concentration on the MCF-7 microtissue .....	27
<b>Figure 3.11</b> : The viability of MCF-7 microtissues at 0 mM RGD concentration.....	28
<b>Figure 3.12</b> : The viability of MCF-7 microtissues at 2 mM RGD concentration.....	28
<b>Figure 3.13</b> : The viability of MCF-7 microtissues at 4 mM RGD concentration.....	29
<b>Figure 3.14</b> : The viability of MCF-7 microtissues at 6 mM RGD concentration.....	29
<b>Figure 3.15</b> : Actin filament & Nucleus dye at 0 mM RGD concentration. ....	30
<b>Figure 3.16</b> : Actin filament & Nucleus dye at 2 mM RGD concentration. ....	30
<b>Figure 3.17</b> : Actin filament & Nucleus dye at 4 mM RGD concentration. ....	31
<b>Figure 3.18</b> : Actin filament & Nucleus dye at 6 mM RGD concentration. ....	31

# ANTITUMOR EFFECT OF RGD PEPTIDE ON CANCER MICROTISSUES

## ABSTRACT

Cancer studies continue to gain interest in the recent period. Many types of cancer, especially breast cancer, continue to cause deaths worldwide and the number of people suffering from this disease is increasing. The methods that are used most at the basis of cancer studies are starting with 2-Dimensional (2D) cell culture. However, 2D cell culture can no longer adequately reflect *in vivo* conditions. Scientists have turned their efforts towards these 3-Dimensional (3D) cell cultures. There are many different ways of obtaining 3D cell culture. The preferred 3DPetriDish™ technique in this study allows functional microtissues to be achieved without using a cell scaffold compared to others. The resulting microtissues reflect the *in vivo* conditions with their substantial effect in the extracellular environment they create, and they are more advantageous than 2D cell cultures and many other 3D cell cultures.

Bioactive peptides can activate vascularization, growth, apoptosis and many other properties on all cell types. It is known that integrin-binding peptides such as IKVAV, RGD have growth promoting properties that enhance vascularization over cancer micro-tissues. The RGD peptide is an integrin binding peptide consisting of the GRGDS sequence. However, RGD peptides are present in the active part of many integrin-binding proteins but have been found to activate caspase pathways at varying levels and to direct apoptosis to cancer cells. Detection of the activation conditions of this effect may have a positive impact on the treatment process, especially considering the recent cancer studies.

This study was carried out to investigate microstructure formation and early development of RGD peptide, MCF-7 3D, in all these data. Micro-tissue size analysis, viability analysis, focal adhesion analysis data were used. As a result of the study, it was noticed that RGD peptides have the effect of reducing growth and development on the cancer microstructure. This effect was seen at high concentrations (6mM) on the first day, but on the following days, all levels were found to show statistically significant differences when compared to the control group. As a result of all these data, increasing concentrations of RGD peptide appear to play an essential role in the formation of 3D MCF-7 microstructure and regulate the growth process. This study shows that drug studies involving RGD peptides may be possible.

# RGD PEPTİDİN KANSER MİKRODOKULARI ÜZERİNDE ANTİTÜMÖR ETKİSİ

## ÖZET

Kanser çalışmalarına son dönemde ilgi artarak devam etmektedir. Özellikle meme kanseri olmak üzere pek çok kanser türü Dünya genelinde can almaya devam etmekte olup bu hastalıktan muzdarip olan kişi sayısı artmaktadır. Kanser çalışmalarının en temelinde kullanılan metotlar 2 Boyutlu (2B) hücre kültürü ile başlamaktadır. Ancak 2B hücre kültürü artık *in vivo* koşulları tam olarak yansıtamamaktadır. Bilim insanları bu gelişmeler sonucunda çalışmalarını 3 Boyutlu (3B) hücre kültürüne doğru yöneltmişlerdir. 3 Boyutlu hücre kültürü elde etmenin pek çok farklı yöntemi bulunmaktadır. Bu çalışmada tercih edilen 3DPetriDish™ tekniği diğerlerine kıyasla hücre iskelesi kullanılmadan pratik mikro dokular elde edilmesine olanak sağlamaktadır. Elde edilen mikro dokular kendi oluşturdukları hücre dışı ortamında büyük etkisi ile *in vivo* koşulları yansıtmakta özellikle 2B hücre kültürüne ve pek çok diğer 3B hücre kültürüne göre daha avantajlı olmaktadır.

Biyoaktif peptitler bütün hücre tipleri üzerinde damarlanma, büyüme, apoptoz ve daha farklı pek çok özelliği aktifleştirebilmektedir. IKVAV, RGD gibi integrine bağlanan peptitlerin kanser mikro dokularının üzerinde damarlanmayı arttırıcı, büyüme destekleyici özelliklerinin bulunduğu bilinmektedir. RGD peptit GRGDS diziliminden oluşan bir integrin bağlanan peptittir. Ancak RGD peptit pek çok integrin bağlanıcı proteinin aktif bölümlerinde bulunmakla birlikte, değişen konsantrasyonlarda kaspaz yollarını aktif ettiği ve kanser hücrelerini apoptoza yönelttiği tespit edilmiştir. Bu etkinin aktifleşme koşullarının tespitinin yapılması özellikle son dönemde artan kanser çalışmaları düşünüldüğünde tedavi sürecine pozitif bir etki yaratabilir.

Tüm bu bilgiler ışığında RGD peptidin MCF-7 3B'lu mikro doku oluşumuna ve erken dönem gelişiminin incelenmesi amacıyla bu çalışma yapılmıştır. Mikro doku boyut analizi, canlılık analizi, fokal adezyon analizi verileri kullanılmıştır. Çalışmanın sonucunda RGD peptidin kanser mikro dokusu üzerinde büyümesini ve gelişmesini azaltıcı bir etkisinin olduğu fark edilmiştir. Bu etki ilk günden yüksek konsantrasyonlarda (6mM) fark edilirken, ilerleyen günlerde bütün konsantrasyonların kontrol grubu ile kıyaslandığında istatistiksel olarak anlamlı farklılıklar gösterdiği bulunmuştur. Tüm bu verilerin sonucunda, RGD peptidin artan konsantrasyonlarının 3B MCF-7 mikro dokusu oluşumunda önemli rol oynadığı ve büyüme sürecini de düzenlediği görülmektedir. Bu çalışma RGD peptiti içeren ilaç çalışmalarının mümkün olabileceğini göstermektedir.

## 1. INTRODUCTION

3-Dimensional (3D) cell culture has as of late been perceived as a favored decision in zones of a regenerative solution, medicate studies, disease, and tissue building. The small-scale tissues made by this procedure impersonate the characteristic habitat of the cell and are utilized as the last middle of the road venture before *in vitro* thinks about are completed *in vivo* ponders. If small-scale tissues are created without the utilization of tissue platforms, they shape their particular grid structures, which enables the cells to multiply faster. This structure that they construct enables them to mimic their common habitat *in vitro*.

Bioactive peptides effectively affect cells, particularly in 3D situations. Distinctive fixations enable cells to give diverse reactions to their environment. RGD peptides are the peptide family comprising of the GRGDS succession which is compelling in cell and cell-surface bond. In past examinations, it has been accounted for that this peptide can duplicate the cell and that diverse groupings of cells additionally enact cell apoptosis instruments. Seeing how and where this action functions can prompt an endeavor that may make the reason for the treatment procedure, particularly given the ongoing disease passing. Since RGD peptides are not immunologically responsive and are reasonable for use in clinical preliminaries, a potential remedial specialist for a disease is conceivably present. The way that RGD peptide union is a minimal effort, fundamental and controllable creation process likewise offers incredible focal points. This impact will give the outcomes on 3D smaller scale tissue the nearest result to *in vivo* considers, and these impacts have already been seen in 2-Dimensional (2D) cell culture. It is proposed, as indicated by all data, to decide the murdering or development capturing properties of the RGD bioactive peptide 3B malignancy miniaturized scale tissue later on to prompt the arrangement of RGD-based mixes.

### 1.1 Purpose of Thesis

In our study previously conducted in our laboratory, certain RGD concentrations decreased size of microtissues and the ratio of living cells. Also, there is an information about RGD peptide's killing effect on cancer. Based on these studies we are aiming to identify the optimum concentration of RGD peptide on the tumor growth during

microtissue formation by using scaffold-free 3D microtissue culture. We mainly focused on establishing a better understanding of the below concepts:

- Determine the effect of optimum RGD concentration on MCF-7 microtissue
- Determine the anti-tumor activity of RGD
- Describe microtissue viability with RGD

## **1.2 Literature Review**

### **1.2.1 3D systems**

Lately, 3D cell culture scientists have caught a critical pattern as far as closeness to the appropriate responses given by cells to numerous regular conditions; nonetheless, the significant portion of these investigations was done in 2D condition (monolayer). 3D cells are isolated from the monolayer cell culture and their biochemical pathways as far as both physiological and morphological perspectives are unique. 3D tissues serve numerous focal points in the method for imitating living tissues as indicated by monolayer culture [1; 2; 3; 4]. Microtissues with 3D cell culture display distinctive morphology, quality articulation profiles and physiological pathways which incorporate cell flagging, separation limit and expansion rate from monolayer culture in light of various parameters, for example, mechanical power in tissue, cell to cell association and cell-grid cooperation [5; 6; 7]. Although the current utilization of 2D cell culture is regularly favored in research facilities, monolayer methods constrain with cell-cell communication in the edge of cells, delivering extracellular matrix (ECM) proteins which are surface, push fiber and nuclear grip proteins and cell association. It has a low expansion rate, and it is demonstrated loss of cell structures because of the separation limit and diverse states of cells contrasted and 3D systems. Moreover, it displays intemperate unconstrained practices, and only 50% of the cell skeleton or less collaborates with ECM [1]. Moreover, 2D systems confine copying *in vivo* conditions, and it has low remedial impacts; likewise, it constrains in sedate research. To dispense with the more significant part of the weaknesses of 2D monolayer cell culture, 3D systems which are more confused were produced, and usable of the method has quickened. Microtissues can beat those downsides and

furthermore shows to all the more likely copy *in vivo* conditions. Note that outline an unusual situation that mirrors the living tissue beyond what many would consider possible, 3D tissues can give the best reaction of tissues as a result of aftereffects of joining microtissues was watched more perfect than a monolayer [2; 3]. In this manner, 3D cell culture is described as a transitional frame between 2D cell culture and *in vivo* explores. While *in vivo* tests have numerous inconveniences, for example, monetary and moral issues, 3D systems are exceptionally pertinent, ease and do exclude moral issues, because of these reasons it is better than monolayer culture. [8; 9; 10; 11; 12; 13].

3D systems can be arranged into two groups. These:

1. Scaffold-Based
  - a. Natural Scaffolds
  - b. Synthetic Scaffolds
  - c. Micropatterned Surface Microplates
2. Non-Scaffold Based
  - a. Hanging Drop Method
  - b. Spheroid Forming (Platform free)
  - c. Microfluidic 3D Cell Culture

#### **1.2.1.1 Scaffold based 3D cell cultures**

In tissue engineering, tissues form different structures and properties. Also, a scaffold should host cell adhesion, proliferation, and extracellular matrix production. For the need of the end result membranes, tubes, gels or 3D matrices can be developed [14]. Each scaffold is chosen for its purpose. Collagen gels can be used for the preservation of cells. Hydrogels, for instance, can enclose and represent a proper environment for isolated cells. Some gels can be directly injected to the targeted site, and semipermeable gels can be a support for cells for places at limited communication occurred [15].

Scaffolds should be able to support and at the end complete the final goal where the place need for tissue engineering. On the other hand, scaffolds must be reproducible, cost-effective and controlled. Restrictions from standard issues and complexity difficulties make this production harder. In the end, there are few institutions for production. Most scaffolds are produced from a natural or synthetic polymer. Ceramic materials mainly used for bone tissue engineering but more often combined with polymers. This process improves their mechanical and biological properties [16].

### **Natural scaffolds**

Natural scaffolds extract from natural polymers such as collagen, fibrin, fibroin, chitosan, alginates, and starch. All of them can be extracted from plants, animals or human tissues. However, their main disadvantage is their variability. They vary batch-to-batch and the purification process is difficult [17; 18].

### **Collagens**

Collagen is widely used polymer for tissue engineering. It is a fibrous protein with stiffness property. They generally were chosen for its mechanical properties as support for connective tissue and template structure for the cell distribution. Because of its triple-stranded helical structure, it is used for capillary formation.

There are mainly three type of collagen;

-Type-I (Found in skin and bone)

-Type-II (Found in cartilage)

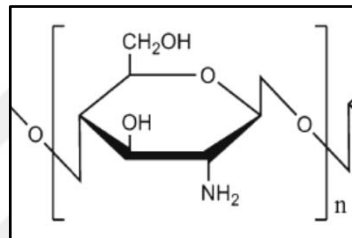
-Type-III (Found in blood-vessel walls)

The most widely used method for producing porous collagen scaffolds is freeze-drying. In this method, collagen suspension with salt crystals freeze for producing stiff structure where the porous occurs in the places for salt crystals. They mainly used for developing blood vessels, tendons, tissues, and nerve regeneration [19; 20; 21; 22].



## Chitosan

It is a natural polysaccharide generally found in the exoskeleton of insects. It is the N-deacetylated derivative of chitin (Figure 1.1). In its structure, there are randomly linked  $\beta$  (1-4) d-glucosamine with N-acetyl-d-glucosamine groups. Enzymes such as chitosanase and lysozyme can degrade it. The rate of degradation depends on its amount of residual acetyl content. This affects the physical and mechanical properties with the degradation amount. They generally produced by ionic bonding but, for increasing its strength covalent cross-linking is also used. They can also be used with other agents for improving other properties such as angiogenesis or drug delivery [23].



**Figure 1.1** : Chitosan Formula.

## Glycosaminoglycans

Glycosaminoglycans are proteins which are mainly found in the extracellular matrix. Their long unbranched chains consist of disaccharide units which contain carboxylic and/or sulfate ester groups. These functional groups link collagens to form an interpenetrating extracellular matrix. One of the examples of glycosaminoglycan is hyaluronan. Hyaluronan mainly found in mammalian connective tissue. It has repeating disaccharide units of N-acetylglucosamine and glucuronic acid. It can bind high amounts of water. Hyaluronic acid can be derived from natural sources like rooster combs. The main advantage of it is isolation and modification [24].

## Silk fibroin

Silks are stringy proteins that are delivered as a fiber by silkworms and bugs. The fibroin is broken up (for the most part in water included with LiBr) and reprocessed. Beginning from recovered silk arrangements, an assortment of biomaterials, for example, gels, wipes, mats/nets, and movies have been delivered and proposed for

therapeutic applications. Silk fibroin materials display suitable biocompatibility and have been exhibited to have the capacity to help the development of human cells [25].

### **Agarose**

Agarose is a polysaccharide polymer extracted from red seaweed and generally utilized in different fields of biomedical research. Its sub-atomic structure is made out of a rotating copolymer linkage of 1,4-connected, 3-6 anhydro- $\alpha$ -galactose and 1,3-preferred  $\beta$ -d-galactose. Because of the high measure of hydroxyl gatherings, it is exceptionally dissolved in water. A double helix structure is shaped by the interaction of two agarose chains connected by hydrogen bonds. Agarose materials experience enzymatic degradation by the activity of agarases, and the properties of agarose gels, particularly quality and porousness, rely upon the grouping of agarose. Agarose is utilized in tissue culture scaffolds since it allows cells to become inside a three-dimensional suspension. Agarose gels are utilized in tissue recovery [26].

### **Alginate**

Alginate is a polysaccharide which is found in the cell walls of brown algae. It has two repeating monomer units:  $\beta$ -d-mannuronate and  $\alpha$ -l-guluronate. Alginate's mechanical properties and physical features depend on the chain length and properties of the guluronate blocks. They are used to encapsulate cells [27].

### **Starch**

Starches, polysaccharide sugars comprising of glucose units connected by glycosidic bonds, can be removed from regular sources like corn, and mainly, starches got from corn, rice, and wheat have been broadly proposed for an extensive variety of biomedical applications. Starch consists of two types of molecules: the linear and helical amylose and the branched amylopectin. Starch-based polymers have been considered a good choice as biomaterials due to their biocompatibility and degradability. Starch-based polymers have been studied a great supply as biomaterials due to their biocompatibility and degradability. On the other hand, they are cheap. They are generally blended with other polymers to composite materials [28].

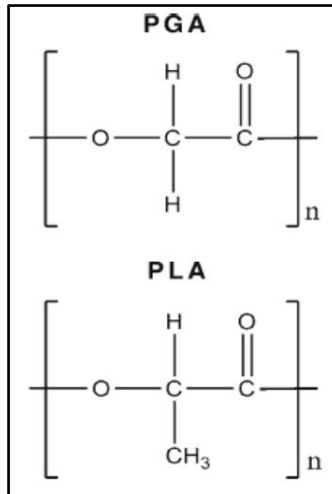
## **Synthetic scaffolds**

Synthetic polymers are chosen due to their high versatility, reproducibility, and excellent workability. In general terms, synthetic polymers can be used more than natural ones, but they are less biocompatible and are not bioactive. Since they are synthetic, the rate of degradation can be arranged easily by selecting the correct polymer or making them copolymers. The widely used ones are polyglycolic acid (PGA), polylactic acid (PLA) and aliphatic polyester polycaprolactone (PCL) [29].

### **Polyglycolic acid, polylactic acid and copolymers**

Polylactic acid (PLA), Polyglycolic acid PGA and their copolymers (PLGA) are bioabsorbable synthetic polymers (Figure 1.2). These straight aliphatic polyesters degrade by hydrolysis with degradation rates relying upon the structure, first molecular weight, uncovered surface area and size, level of crystallinity, connected bonds, measure of lingering monomer and, on account of copolymers, the proportion of the hydroxy acid monomers. Because of their thermoplastic abilities, they can be easily shaped with secure processes like molding, solvent casting, extrusion, and spin casting. Scaffolds can have ordered or randomly distributed fibers which allow them to have different size and amount of fibers and pores [30; 31].

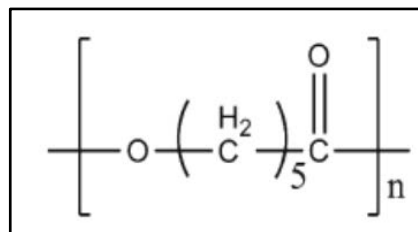
They can be used for transplant cells, regenerate different tissues and combined with ceramic materials made them suitable for bone tissue engineering. Biocompatibility plays an essential role in the long- and short-term success of all implants; for biodegradable devices, both the implant and its degradation products must be biocompatible and nontoxic. Most of them release only nonspecific foreign body mild reactions [32].



**Figure 1.2 :** Polyglycolic acid and Polylactic acid formula.

### **Polycaprolactone**

Polycaprolactone (PCL) is a degradable semicrystalline aliphatic polyester (Figure 1.3). It has crystals and amorphous regions these made it rubbery and flexible at room and body temperature. It degrades by hydrolysis in physiological conditions. When it compared to PLA, the degradation rate of PCL is slow. This property limits its use for fast regeneration for tissue engineering. Therefore, PCL is more suitable for long-term use [33].



**Figure 1.3 :** Polycaprolactone formula.

### **Polyurethanes**

They are produced by the reaction of a diisocyanate and a polyol and in their chain, they contain urethane. Its structure combined with flexible and hard segments. Their good biocompatibility allows them to be good candidates for tissue engineering applications. They are used for different applications like pacemakers, catheters, artificial heart and heart valves. Degradable ones have been developed for myocardial

repair and vascular tissues. Their degradation process releases nontoxic product to the human [34].

### **Poly-ortho ester**

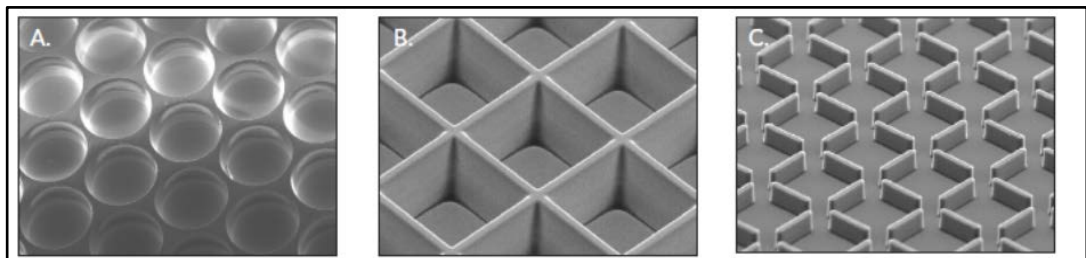
Poly-ortho ester (POE) are in acidic environment degrade by surface erosion. Because of this property, it is mainly used for drug release systems. Degradation process which is occurs with hydrolysis increases with acidic products since they play as a catalyst for reaction. In this process, lactide dimers broken down to lactic acid which is catalyst for ester bonds [35].

### **Polyanhydrides**

Because of its structure, they have also property of surface degradation like POE. Hydrophobic backbone limits water diffusion and lets the degradation occurs on the surface. Because of this property, it is also used as drug release applications [36].

### **Micropatterned surface modification**

This technique uses micro-fabrication technology. Each plate has micrometer sized compartments. All of the components arrange orderly in the bottom of the well. Wells could be in different shapes, including square, round, or square with gaps between the obstructions of adjoining wells (Figure 1.4). Wells are covered to make a low grip surface inside each smaller scale space. On this procedure, cells added to the well at first append to the base of the smaller scale space, at that point total together to shape spheroid-like structures in the compartment over consequent long periods of culture. This gives advantages of reproducibility, known scaffold structures which might affect cells behavior [37].



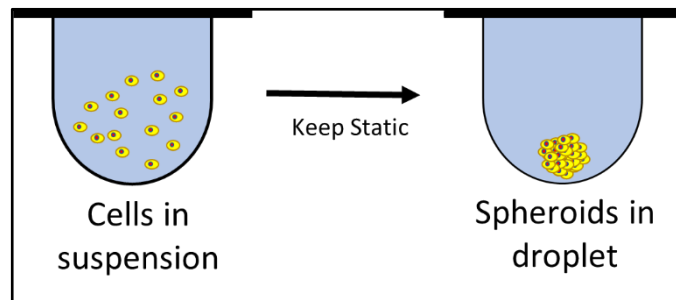
**Figure 1.4 :** Micropatterned Surfaces (**A.** round, **B.** square, **C.** slit patterning. (Images from Elplasia™)).

### 1.2.1.2 Non-scaffold based 3D cultures

Cells can aggregate to each other because of the differential adhesion hypothesis (DAH). According to this hypothesis, there are adhesive and cohesive forces on each cell. When the cells started to aggregate each other, these forces affect the position of the cells in the spheroid. They form spheroids because of these forces [38].

#### Hanging drop method

Cells can form more estimated culture structures since single cells randomly scattered inside a 3D ECM material. Cells are set in hanging drop culture and brooded under physiological conditions until the point that they frame genuine 3D spheroids in which cells are in parallel contact with each other and with extracellular grid segments (Figure 1.5). The strategy requires no particular equipment and can be adjusted to incorporate the expansion of any organic operator in little amounts that might be of enthusiasm for clarifying impacts on cell-cell or cell-ECM connection. Cell-cell cohesion and cell-ECM adhesion are the milestones of tumor-stromal cell interaction, wound healing, and for applications to tissue engineering. Cell suspension drop on the surface of a plate after that with the force of gravity cells aggregates to form spheroids [39; 40].



**Figure 1.5 :** Hanging Drop Method.

#### Microfluidic 3D cell culture

Microfluidic stages can likewise be utilized to make comparative heterogeneous models while contributing an extra level of many-sided quality by acquainting a perfusive stream perspective with the cell condition; considering nonstop sustenance and oxygen presentation and also squander suspension through culture medium. Cells are kept inside a compartment by different physical or non-physical boundaries. Media

containing supplements, synthetics, treatment particles, or recoloring reagents is then perfused past the cells (Figure 1.6). They are made of generally glass or silicon, polymers with polydimethylsiloxane, poly carbonate or polystyrene. On the other hand, cells can be combined with matrix like collagen to increase the cell-ECM interactions. This system is used for tissue engineering applications, tumor research and embryonic cell culture [41].

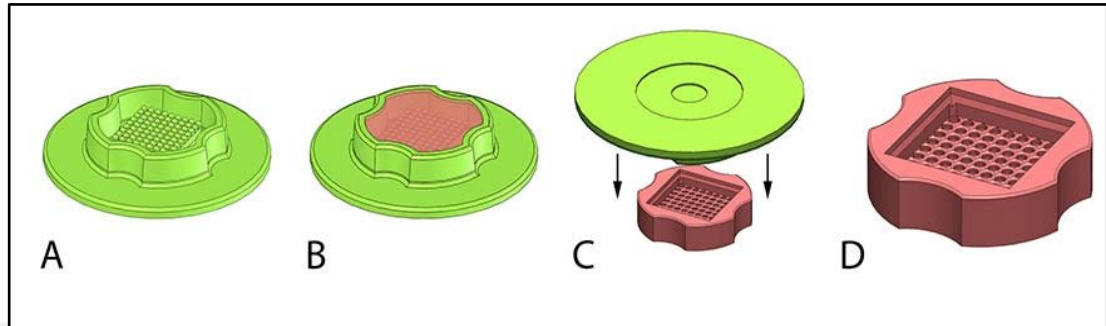


**Figure 1.6 :** Microfluidic Plate (Image from CellASIC®).

### **A platform free procedure: a 3D petri dish®**

Tissue-built 3D developed as a rule for the most part framed on a scaffold and embedded *in vivo* to upgrade tissue recovery process. Since the more significant part of the platform, systems cannot include all the perfect properties for tissue arrangement, a scaffold free approach where 3D microtissue created through cells possess extracellular grid for the most part take after the *in vivo* conditions [42]. Looking at the traditional 3D platform approach, self-get together of cells into microtissue structures permits connections among cells and extracellular grid emission without the prerequisite of extra network material. The scaffold free approach can viably beat the constraints caused by platform materials, for example, satisfactorily copying the standard extracellular network, restricted cell-cell correspondence, non-coordinating renovating and debasement profile [43]. The platform is regularly insufficient to imitate essential errands of ECM that mastermind cell-cell communication in tissue microenvironments while scaffold free microtissue method utilizes cell attractive energy subordinate way and cells create possess lattice notwithstanding grid parts as self-assembly together. Different points of interest of

scaffold free microtissues can be delivered as vast scale, took care of and co-refined. Besides, it is effortlessly checked and controlled *in vitro* tries as opposed to a 3D platform free method (Figure 1.7). The method has significant advantages for tissue recovery so it can be material for pre-clinical research [44; 45].



**Figure 1.7 :** 3D PetriDish® technique (**A.** mold, **B.** mold with agarose, **C.** removing of agarose molt. **D.** Agarose mold (Images from microtissues®)).

### 1.2.2 Model breast cancer cells

Cancer is characterized as the uncontrolled or inadequate development and expansion of cells by DNA damage causing in cells. Mistakes in the direction of the perplexing cell cycle with numerous collaborations; prompting the interruption of control of cell division and ensuring growth advancement in changes at the power focuses. In the prognosis of disease improvement, essential pathways of loss of cell cycle control, hindrance of apoptosis and DNA defect [46].

Malignancy stays as a noteworthy reason for death worldwide despite various methodologies utilized as a part of treatment and counteractive action. Breast cancer malignancy is one of the most well-known tumors and the second driving reason for disease deaths among women after lung growth. Around one million women on the planet and 200,000 women in the United States are determined to have breast cancer consistently. Also, as per American Cancer Society, breast cancer tumor represents roughly 40,000 deaths every year in the United States, and around 400,000 individuals on the planet pass on from breast cancer as indicated by World Conference on Breast Cancer [47].



Breast cancer alludes to a malignant tumor which starts from cells in the breast cancer. Each breast has 15 to 20 segments called flaps, and these projections have numerous littler parts called lobules. The folds and lobules are associated with thin tubes which are called ducts. Breast cancer malignancy can start in various territories of the breast, yet for the most part, it begins in the inward covering of the drain channels or lobules which supply drain to the conduits. Growth that starts in flaps or lobules is called lobular malignancy. The breast cancer tumor which begins in the stromal tissues including the greasy and stringy connective tissues of the breast cancer is less regular. The past decades, chemotherapy has been viewed as the most effective strategy for malignancy treatment, yet the related cost and trouble of symptoms has much of the time declined patients from repairing to chemotherapeutic measures. Thus, there has been a constant scramble for the advancement of better substitute therapeutics [48].

Breast cancer is a complex and heterogeneous disease. In order to understand disease cell type selection is an important parameter. HeLa is the first cell line utilized for cancer studies. It is a well-known cell line today. One of the major benefits of using a well-known cell line is the relatively infinite supply. First breast cancer cell line established was BT-20. However, today most widely used breast cancer line is MCF-7 [49]. Because of its intense hormone sensitivity through the expression of the estrogen receptor. On the other hand, the protocols of using MCF-7 cell lines have already been standardized and given responds are closer to *in vivo* conditions.

The cells, derived from a breast cancer growth persistent in the Detroit territory and created at the Michigan Cancer Foundation, Detroit, became a standard-model in hundreds of research centers far and wide. MCF-7 is the acronym of Michigan Cancer Foundation-7, alluding to the organization in Detroit where the cell line was set up in 1973 by Herbert Soule and collaborators. Prior to MCF-7, it was unrealistic for disease scientists to acquire a mammary cell line that was equipped for living longer than a couple of months [50].

### **1.2.3 Biofunctional peptides**

Proteins are fundamental materials of natural systems vast natural exacerbates that are shaped because of the chain of polypeptides being connected. Peptide pieces order protein structures. Peptides have an extensive variety of the human body. Therefore

peptides research has accelerated great rate [51; 52]. Undertakings of a successful polypeptide chain of proteins can be distinguished in research facility conditions because of vital capacity, or significant chain of protein can be portrayed. General depicting of peptides should be possible as a compound comprising of at least two amino acids connected as covalent bond in a chain. The carboxyl group of each acid is added to the amino group of the next by a bond of the type -OC-NH- [53].

Strong Stage Peptide Blend (SPPS) is a method which can combine high virtue peptides on strong gum and has low conservative issues. SPPS is better than traditional solution peptide synthesis methods since it has necessary sanitization and isolation stage and accessible automatization. Additionally, SPPS method runs extreme coupling reagent in reaction duration [54]. Carboxyl groups of C terminal of aminoacids bind to support materials which are named resin and reactive groups of aminoacids are protected by special chemical materials such as Fluorenylmethyloxycarbonyl chloride (Fmoc) or t-Butyloxycarbonyl (Boc). In the case of authoritative of amino acid to tar or amino acid, ninhydrin test was utilized and if restricting procedure was ordinary, new amino acid including strategy could proceed however if amino acids did not tie the tar, the amino acid was included once more. After all amino acid sequence groupings were accurately added to pitch, deprotection methodology applies which is the last procedure of peptide blend. In this procedure, built peptide isolates from tar particles [55].

SPPS uses Fmoc and Boc chemical components as closed polar however ordinarily Fmoc is used to tests because of low-cost effect and its responses to therapeutic agents, medicinal chemistry and drug delivery studies. Fmoc SPPS is accessible for original investigations and straightforward to deal with because it is destructive when it looked with trifluoroacetic acid (TFA) in the manufactured cycles. While Boc aggregate hinders racemization amid enactment and authoritative, Fmoc assembles discharges a gathering of urethane moderating mixes containing the benzyl carbamate (benzyloxycarbonyl) which influence cell capacities [56; 57].

Peptides in tissue designing, help to control cell culture by adjusting substance of surfaces and imitating elements of proteins *in vivo* conditions. After entered own task in the microenvironment, it can be easily degraded. Furthermore, cell connection

execution can be upgraded by covering a surface of materials and how cells act in a material with the peptide can be analyzed in medium without serum. Peptides catch a pattern in tranquillize conveyance and quality treatment contemplates because of surface change should be possible by peptides [52; 58]. Another critical purpose of utilizing peptides is to advance cell expansion through copying ECM proteins, for example, vitronectin, laminin, and fibronectin *in vitro*. Notwithstanding, those ECM molecules are substantial protein successions, expansive peptides are not steady shape, hard to synthesise and short peptides. Although self-get together can be seen in vast peptides, short peptides have numerous points of interest and furthermore generally utilized as a part of analyses in light of every one of these burdens of substantial groupings. [54; 58; 59].

#### **1.2.3.1 RGD (GRGDS) peptide**

Biomimetic materials are usually utilized as a part of a variable region, particularly biomimetic materials in tissue designing give necessary help and amplify into a place for cells or tissue [59]. The most prevalent contemplated peptides are RGD peptides which comprise of arginine (R), glycine (G) and aspartate (D) successions and there is various RGD theme, for example, GRGDS, RGDSC. Expansive themes of RGD is more particular than just RGD arrangements. The peptide has integrin restricting undertaking which ties to vitronectin, fibronectin, fibrinogen, osteopontin, laminin, collagen and bone sialoprotein [58; 60; 61].

The arrangements are reasonably successful in connection of cells, and it gives the high ability of integrin restricting locales and control of cell proclivity. While utilized individual ECM molecules prompt strong reaction and it has a risk joined microbial contamination, RGD peptides do not initiate insusceptible reactivity, and it is material in clinical specialists. RGD synthesis has primary and taking care of the process, customizable focus and minimal effort [62]. It has controlled impact because fundamentally RGD peptides attach on integrin molecules which have active parts in a cell-scaffold association. It has additionally compelling part in angiogenesis period. It increases cell expansion and cell development. In this way, the peptide can improve connection amongst cells, and it can hold cells in particular ECM particles. The execution of RGD peptides continues working period and remain stable *in vivo* and *in*

*in vitro* condition. It can adjust to various surfaces and coat to implantable materials. Subsequently, materials can pick up usefulness and be controlled, for example, cell movement. Compelling unit of fibronectin atoms which is RGD acts together with other ECM particles. Just RGD area could not prompt integrin flag pathways in local tissue [53; 59].

One of the advantages of RGD is, it ties the purpose of the cell-network association, and it can be a drag apoptosis pathway. One of the disadvantages of RGD peptide, it is grouping which is Arg-Gly-Asp did complex with some particular vascular proteins, for example, engine and annastellin amid vascularization and it directs angiogenesis and vasculogenesis. Another drawback is RGD peptides is, molecular pathways of RGD still are not well described. [63].

#### **1.2.4 Apoptosis**

Apoptosis is programmed cell death which is a physiological cellular process that occurs in living things during the regular life cycle. In multicellular organisms, the number of the cells compensated by cell deaths and divisions [64; 65].

##### **1.2.4.1 Mechanisms of apoptosis**

There are different ways to follow for apoptosis mechanism. Caspases lead some of them, signalling molecules, particular cells or proteins [64].

##### **Apoptosis induced by caspases**

Proteins that are effective in the apoptotic pathway in the vertebrates are called caspases. They are named cysteine-aspartic proteases due to their specific cysteine protease activity. They carry a cysteine residue, which plays an essential role in catalytic domains, an aspartate at their C-terminus against the proteins and an enzyme. 15 different caspases have been identified in humans. Caspases are synthesized as procaspases, and then cut off a specific part of them and become active caspases. In this apoptosis pathway, a protein-induced caspase-9 activates by activating some aspects of caspase-3. Activated caspase-3 inactivates inhibitor of caspase-activated deoxyribonuclease (ICAD) in the cytosol. Inactivated ICAD is separated from ordinarily bound caspase-activated deoxyribonuclease (CAD). The released CSD

enters the nucleus, causing chromatin condensation and DNA breaks which is leading to cell apoptosis [66].

### **Apoptosis induced by signalling mechanisms**

Apoptosis can be observed in the presence of signals. For example, Tumor Necrosis Factor (TNF) which is synthesized by macrophages and Fas ligand that is synthesized by cytotoxic T lymphocytes. Both of them can also lead to apoptosis. Both of them work through death receptors found in the target cells. They activate receptor when they bind. The activated Fas receptor attracts the intracellular protein called the TNF receptor-associated death domain (TRADD), which is activated as FADD (Fas-associated death domain) that activates caspase. Both the TNF and FAS receptors, also called death receptors, require that some cytosolic proteins, such as FADD and TRADD which have an amino acid site that transmits the death signal. Caspase-8 is further activated by cleaving its proenzyme form by itself. The target of caspase-8 is mitochondria, and caspase-8 is bound to the active caspases in the mitochondrial cytochrome C, which act as proenzymes, and leads to the activation of caspases effective in the presence of caspase-8. Activated caspases also lead to cell death [67; 68].

### **Apoptosis induced by immune cells**

Cytotoxic T lymphocytes secrete granules containing lytic components such as serine protease and perforin. The perforin released from cytotoxic T lymphocytes binds to the target cell membrane, forming channels there which kills the target cells. The serine protease in the granules also passes through the target cell in the presence of perforin, activating the caspase pathway, activating the procaspases, thereby causing the cell to enter apoptosis [69].

### **Other proteins that induce apoptosis**

Even though caspases do much valuable work in apoptosis, death may occur in cells without caspase activation. Apoptosis Inducing Factor (AIF) and Endonuclease G are the proteins that lead to this mechanism by releasing from mitochondria. AIF is a flavoprotein. After the apoptotic stimulation, it moves to the nucleus. In the core, AIF causes chromatin condensation and separation of DNA into particles. Endonuclease G

usually serve to separate RNA-DNA hybrids during transcription. After the apoptotic stimulation, it separates from mitochondria and isolates DNA [65].

### **1.2.5 Antitumor effect of RGD peptides**

Since RGD motif is an integrin-recognition motif found in many ligands, it has been widely used as inhibitors of integrin-ligand interactions. It also can induce apoptosis without any requirement for integrin-mediated cell clustering or signals. RGD-containing peptides directly induce auto processing and enzymatic activity of pro-caspase-3. For achieving cell death, caspase -3 required [63]. A previous study that has carried out in our laboratory was demonstrated, increased concentration of RGD reduced the diameter of microtissue and the ratio of living cells [70]. RGD has different antitumor effects on cancer cells. It can affect their adhesion and migration, induce tumor apoptosis and inhibit their angiogenesis. Integrin  $\alpha v \beta 3$  is a heterodimeric glycoprotein and it played a role regulation of cell-cell and cell-ECM interactions. Therefore, it is a suitable choice for therapeutic intervention [71]. A study has done by Mitjans et al. [72] focused on this point. They characterized RGD peptide and monoclonal antibody (MAb) in vivo that acted as an  $\alpha v$  antagonist for inhibiting human melanoma tumor growth. They found that the cyclic RGD peptide targeted with MAb could inhibit  $\alpha v$  integrin for cellular adhesion. On the other hand, Anuradha et al. [73] found RGD induce apoptosis by activating caspase-3 that cause DNA fragmentation and cell death. This leads RGD could also induce apoptosis. Since  $\alpha v$ -integrins ( $\alpha v \beta 3$ ,  $\alpha v \beta 5$ ) regulate connections of endothelial cells during tumor angiogenesis, inhibition of these integrins could block angiogenesis on the tumor. Eliceiri and Cheresh [74] showed blocking  $\alpha v$ -integrins with cyclic-RGD peptide resulted in significant reduction of vessel density, delaying growth and metastasis of a tumor in vivo

## **2. MATERIALS & METHODS**

### **2.1 Peptide Synthesis**

100 mg resin was swelled in 2ml Dimethylformamide (DMF) solution for 20 min. Fmoc-protecting group was removed using de-protection solution which is 20% piperidine in DMF for 20 min. 2 equivalents (based on resin substitution) of Fmoc-protected amino acid was dissolved in DMF and added to the resin. 2-(1H-benzotriazole-1-yl)-1,1,3,3-tetramethyluronium hexafluorophosphate (2 equiv, HBTU), hydroxybenzotriazole (2 equiv, HOBt) and N, N-diisopropylethylamine (4 equiv, DIEA) were added to mixture. Tubes were mixed in an orbital shaker to proceed coupling reaction for 3 hours. Each coupling and the de-protection reaction was confirmed by ninhydrin test. If the result was positive, the resin was washed with DMF and the coupling reaction was repeated until a negative result was obtained. If the test result was negative, the resin was washed with DMF, reacted with 20% piperidine in DMF for 15 min, and again washed with DMF. All amino acids were coupled using the same method. When the last amino acid was coupled, the peptide was cleaved from the resin by using trifluoroacetic acid (TFA): triisopropylsilane (TIPS): DI Water solution at a ratio of 95 : 2.5 : 2.5. TFA was evaporated with the rotary evaporator. The peptide was precipitated in ice-cold diethyl ether. Next, precipitated peptide was washed by ice-cold diethyl ether three times. Finally, the resulting pellet was freeze-dried [55]. All peptides were purified and characterized by preparative high-pressure liquid chromatography (HPLC, Agilent 1260 Quaternary LC) equipped with mass spectrometry (Agilent 6530 Q-TOF) with an electrospray ionization (ESI) source.

### **2.2 Cell Culture**

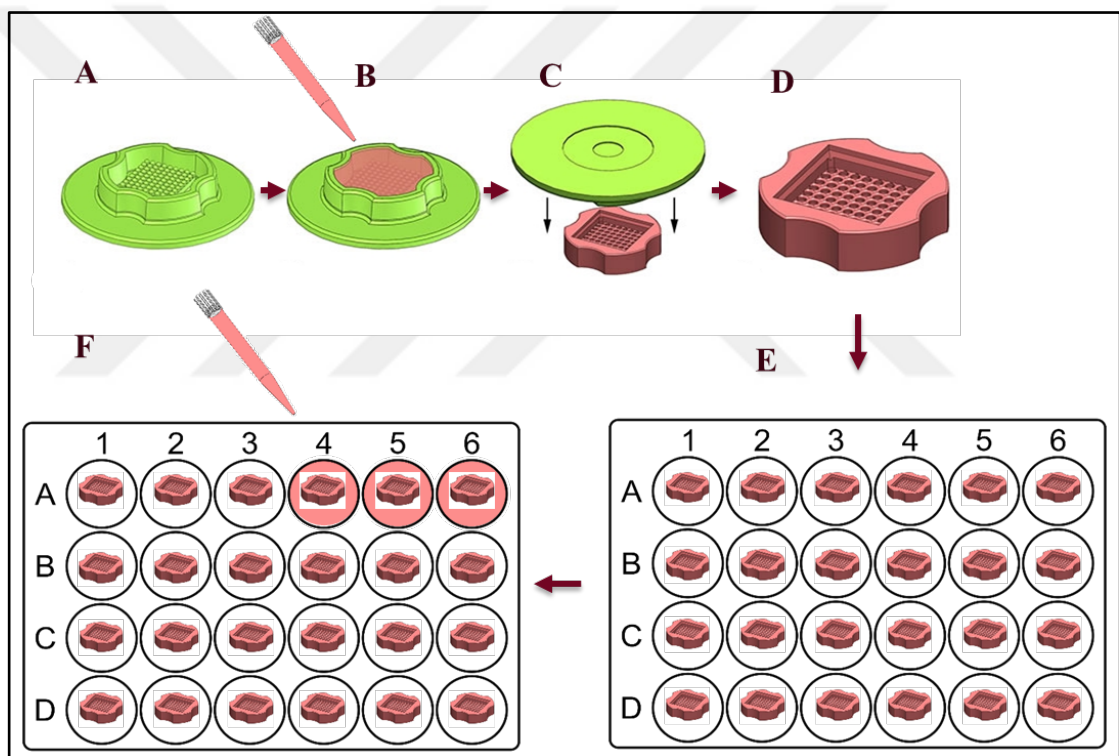
#### **2.2.1 2D Cell Culture**

MCF-7 cell line was used between passage numbers 22-27. The cell line was taken from Ege University, Bioengineering Department, Animal Cell Culture and Tissue Engineering Lab. Monolayer culture was done by DMEM (DMEM-Dulbecco's Modified Eagle Medium, Sigma, D6046) which includes 1% L-Glutamine (Gibco, 25030081) and 1% Penicillin (Gibco, 15140122), %10 FBS (Fetal Bovine Serum,

Sigma, F6765). Media was replaced per 2 days. When MCF-7s were 80-90% confluent, they were washed 3 times with PBS and passed to use for 3D cell culture by using trypsin-EDTA (Gibco, 15090046) solution. After waiting 5min. in 5% CO<sub>2</sub> 37 °C in the incubator, cells were centrifuged at 900 rpm, 4 °C, and 5 min. the number of cells was calculated trypan blue dye with a hemocytometer.

### 2.2.1 3D Cell Culture

To construct the cancer microtissue, 330 µl agarose gel was created by 3D petri dish (24 well) as shown in Figure 2.1. The agarose gel was incubated to accommodate cells at 30 min. with media after that MCF 7's was added then held 30 min. in the incubator.



**Figure 2.1 :** 3D Cell Culture (A. 3D PetriDish™ mold, B. pouring molten agarose, C. removing of agarose mold, D. Agarose mold E. Putting agarose molds to 24 well plate, F. Pouring cells with media).

### 2.3 Live & Dead Assay

Double Staining Kit (Dojindo, Molecular Technologies, Inc, Japan) is used to demonstrate the rate of viable or dead cells in microtissue. The medium was attentively



removed and the mold was washed 3 times with PBS. A stock solution of dye was prepared by using 1 mmol/L solution A-green (Calcein-AM/DMSO) and 1,5 mmol/L solution B-red (PI/purified water). The solution was applied by 500  $\mu$ l. After incubation for 15 min., at 37°C, the solution was removed and then washed 5 times with PBS again. The microtissues were observed under the fluorescent microscope (Olympus) in 10x and 40x magnification. Both live (green) and dead (red) cell micrographs were taken separately and merged with CellSense Entry software, too.

#### **2.4 Actin Cytoskeleton/Focal Adhesion Staining Kit**

This kit was used for understanding cell viability and cell configuration of microtissue. Phalloidin stains actin filaments which are important for the understanding of vascular structures. To understand the places of the cell nucleus, DAPI was used. After removing the media from agarose mold, the mold was washed 4 times with PBS without damaged the microtissue. Microtissue was fixed at 4% paraformaldehyde 20 min. at room temperature. They washed 3 times with PBS and incubated with 0.1% Triton X-100 in 1x PBS for 1-5 min. at room temperature. Molds were washed 3 times with PBS again. They blocked by using 1% BSA (Bovine Serum Albumin). TRITC conjugated Phalloidin was prepared as 1:1000 ratio within 1X PBS and incubated for 60 min. each agarose mold at room temperature. After 3 times washed with PBS, the mold treated with DAPI at room temperature 5 min. and washed 5 times with PBS, 5 min for each washing operation. The micrographs were observed under the fluorescent microscope (Olympus) in 10x and 20x into PBS. Red dye represents phalloidin and blue dye represents DAPI which is the nucleus of cells. Cell micrographs were taken separately and merged with CellSense Entry software.

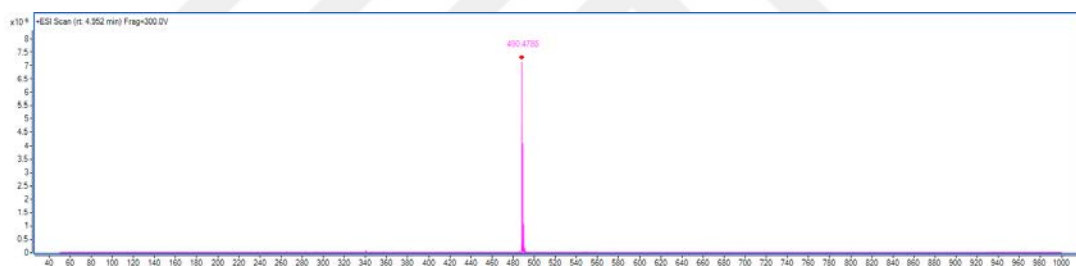
#### **2.5 Analysis of Cancer Microtissue's Diameter Size**

Three independent experiments were performed and in each experiment, three cell seeded molds were used for each experiment group. The images taken from the same cell seeded wells for each group at 1<sup>st</sup>, 4<sup>rd</sup> and 7<sup>th</sup> day. Image-J software (NIH) was used for diameter size analysis of cancer microtissues. All data were expressed as a

mean  $\pm$  standard error and were statistically analyzed by T-TEST. Significant differences between groups were determined at  $p$  values at least than 0.05.

### 3. RESULTS

Purity and characterization of synthesized RGD peptide was measured by HPLC. Calculated molecular weight of RGD is 489.49 g/mol and measured value from mass spectra (Figure 3.1) was observed as 490.4785 g/mol. Therefore, calculated and observed molecular weight of RGD matched (Table 3.1). As the result obtained from liquid chromatography and mass spectra indicate that synthesized RGD peptide has high purity ratio (Figure 3.2).



**Figure 3.1** : Ionization mass spectra of RGD peptide.

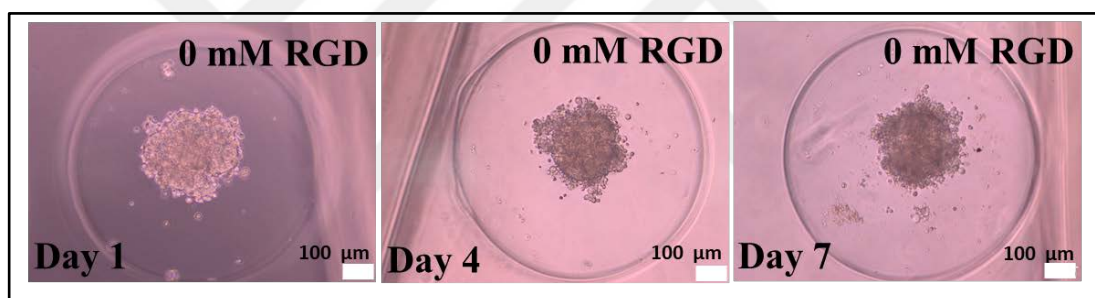


**Figure 3.2** : Liquid chromatography spectra of RGD peptide.

**Table 3.1** : Sequence, observed and calculated molecular weight of RGD peptide.

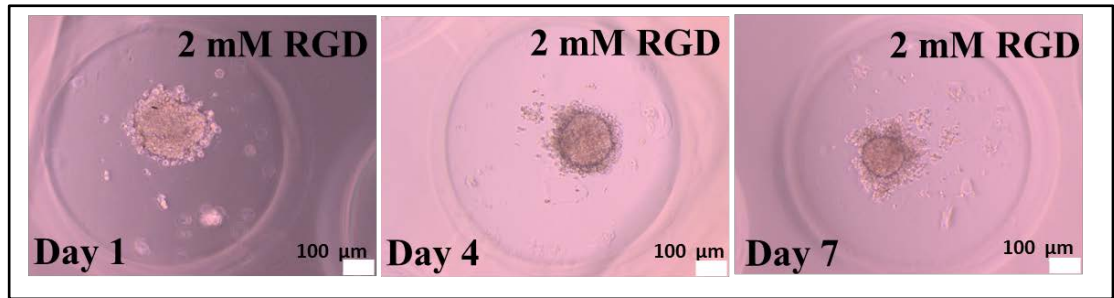
Name	Sequence	Calculated	Observed
RGD	GRGDS	489.49 g/mol	490.4785 g/mol

Containing different RGD concentration DMEM media was used for each group (n=6). The experiment was materialized 100,000 cell/ 75  $\mu$ l. RGD peptides were calculated as 0 mM as a control group, 2 mM, 4 mM and 6 mM. Diameters were measured at the least 3 times by Image-J software (NIH). Figure 3.1 represents micrograph of microtissues at 1st, 4rd and 7th days in 100  $\mu$ m scale bar.



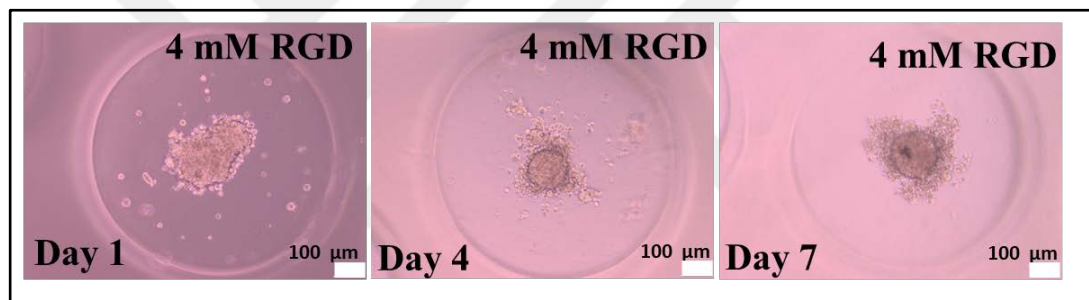
**Figure 3.3** : The effect of 0 mM RGD peptides on tumor microtissue formation at 1<sup>st</sup>, 4<sup>rd</sup> and 7<sup>th</sup> days.

Diameter of microtissues did not show significant difference at 0 mM RGD concentration (Figure 3.3). However, a significant decrease in microstructure diameter was observed at 2 mM RGD (Figure 3.4).



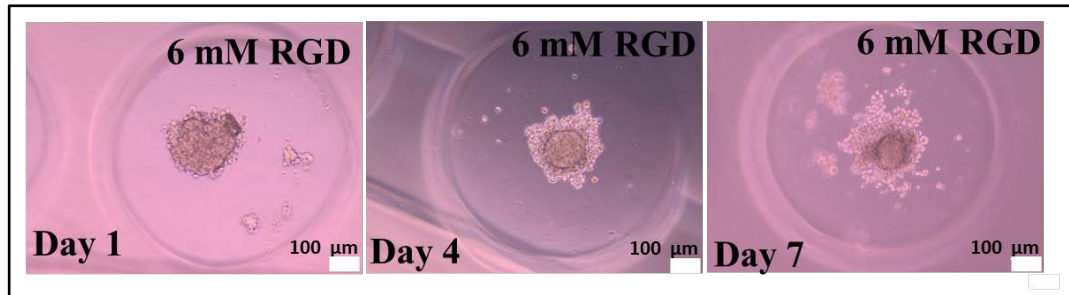
**Figure 3.4** : The effect of 2 mM RGD peptides on tumor microtissue formation at 1<sup>st</sup>, 4<sup>rd</sup> and 7<sup>th</sup> days.

Therefore, the observed reduction in diameter was more noticeable than 2 mM RGD at 4 mM RGD (Figure 3.5).



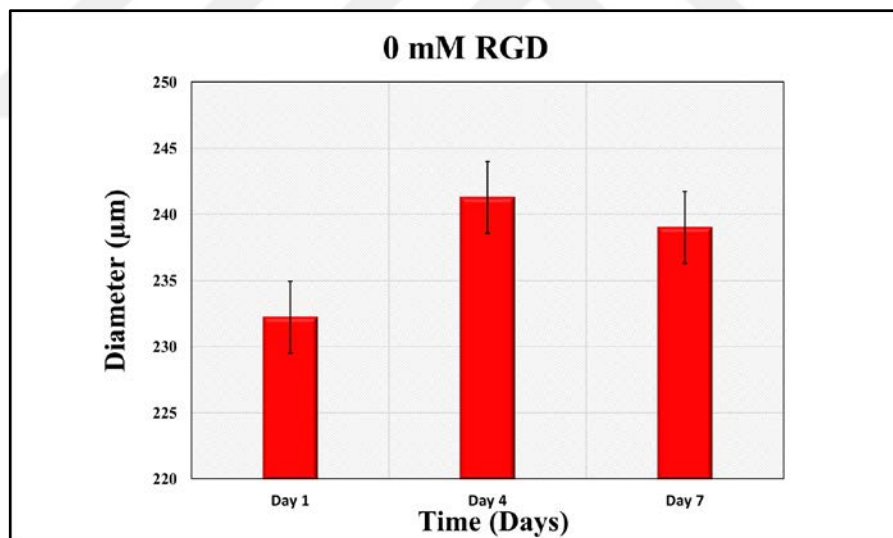
**Figure 3.5** : The effect of 4 mM RGD peptides on tumor microtissue formation at 1<sup>st</sup>, 4<sup>rd</sup> and 7<sup>th</sup> days.

The most significant size reduction observed was 6 mM RGD (Figure 3.6). While a significant decrease in diameter was observed in all RGD concentrations, this reduction of microtissue size increased with the increase in RGD concentration.



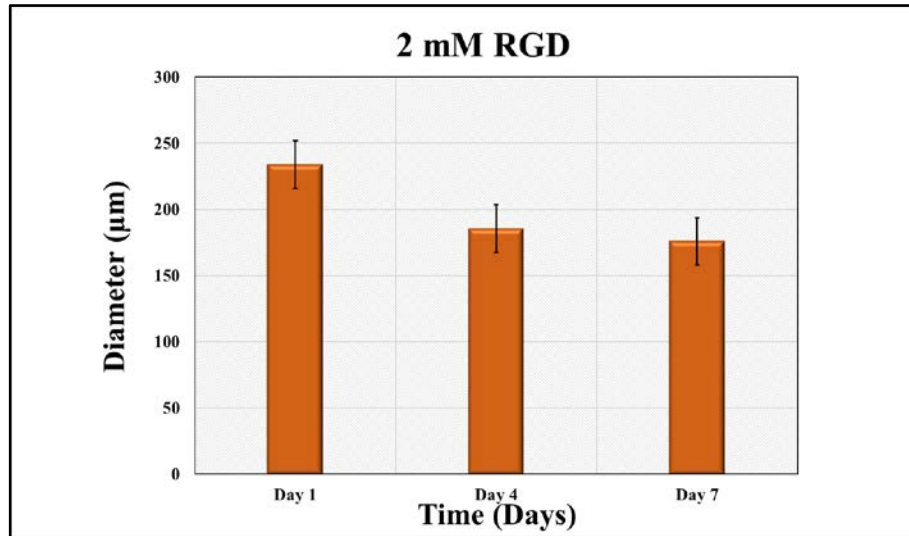
**Figure 3.6** : The effect of 6 mM RGD peptides on tumor microtissue formation at 1st, 4rd and 7th days.

The average size of microtissues on 0 mM RGD concentration were  $232.21 \pm 11.61$ ,  $241.28 \pm 12.06$  and  $239.01 \pm 11.95$  μm in Figure 3.4, respectively 1<sup>st</sup>, 4<sup>rd</sup> and 7<sup>th</sup> days. The results shows there is an increase on microtissue size until 4<sup>rd</sup> day. After the 4<sup>rd</sup> day size of the microtissues slightly decreased just under the 240 μm.



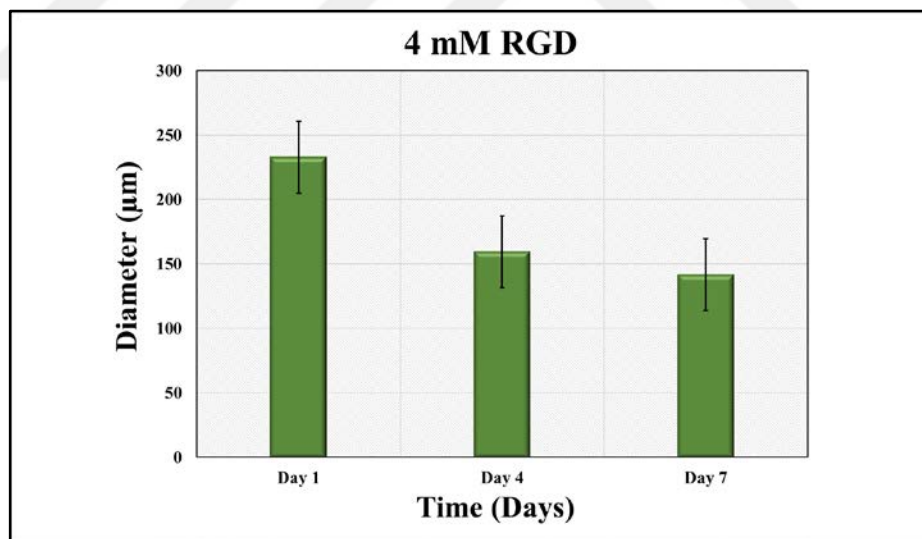
**Figure 3.7** : Effect of 0 mM RGD concentration on the MCF-7 microtissue.

The average size of microtissues on 2 mM RGD concentration were  $233.85 \pm 11.69$ ,  $185.46 \pm 9.27$  and  $175.86 \pm 8.79$  μm in Figure 3.5, respectively 1<sup>st</sup>, 4<sup>rd</sup> and 7<sup>th</sup> days. Size of the microtissues on 2 mM RGD constantly decreased until the 7<sup>th</sup> day.



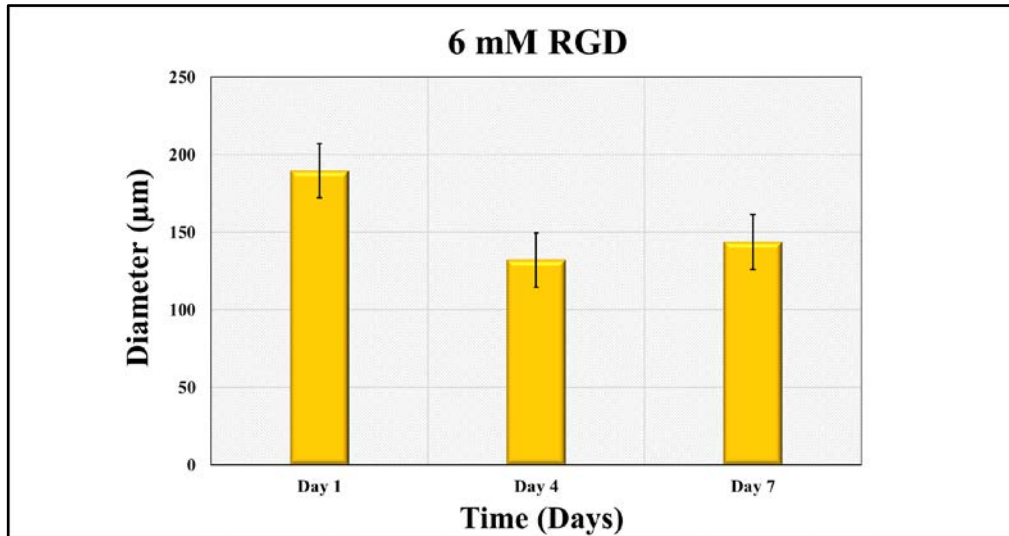
**Figure 3.8** : Effect of 2 mM RGD concentration on the MCF-7 microtissue.

The average size of microtissues on 4 mM RGD concentration were  $232.75 \pm 11.63$ ,  $159.41 \pm 7.97$  and  $141.69 \pm 7.08$  µm in Figure 3.6, respectively 1<sup>st</sup>, 4<sup>rd</sup> and 7<sup>th</sup> days. Diameter of the microtissues on 4 mM RGD constantly decreased until the 7<sup>th</sup> day.



**Figure 3.9** : Effect of 4 mM RGD concentration on the MCF-7 microtissue.

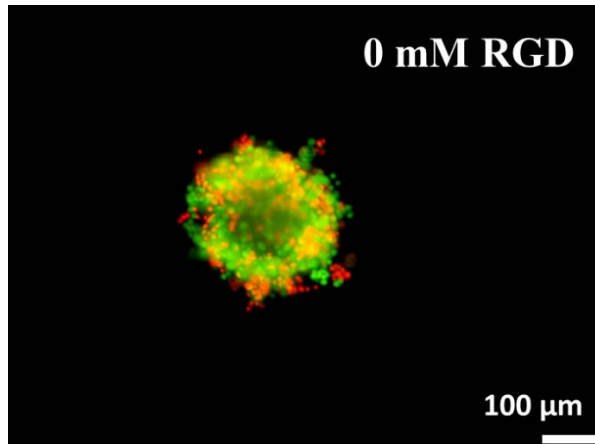
The average size of microtissues on 6 mM RGD concentration were  $189.6 \pm 9.48$ ,  $132.01 \pm 6.6$  and  $143 \pm 7.18$  µm in Figure 3.7, respectively 1<sup>st</sup>, 4<sup>rd</sup> and 7<sup>th</sup> days. Diameter of the microtissues on 6 mM RGD constantly decreased until the 4<sup>th</sup> day. After the 4<sup>rd</sup> day size of the microtissues remained constant just under the 150 µm.



**Figure 3.10** : Effect of 6 mM RGD concentration on the MCF-7 microtissue.

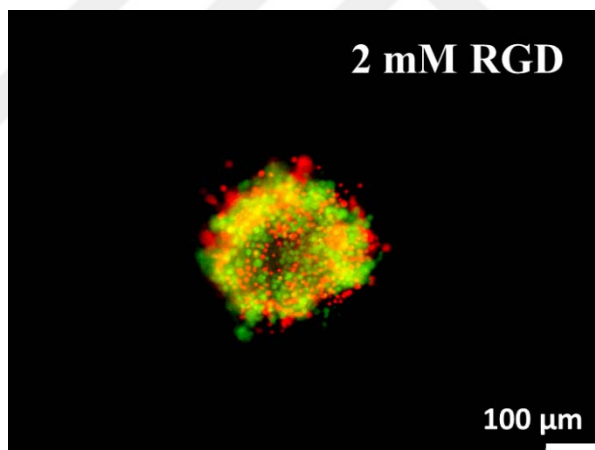
On the 1st day, respectively and the statistical difference was found at 6 mM RGD compared to the control group ( $p^{***} < 0.001$ ). At 4rd and 7th day, all groups were different compared to the control group statistically ( $p^{***} < 0.001$ ).

To understand the viability of microtissues, live and dead assay was applied and the highest death ratio was observed in 6 mM RGD peptides as surveyed in Figure 3.11. It was examined three samples from all groups at 7th day in 100 µm scale bar. While increasing RGD concentration, the ratio of death cells/ living cells was also increased.



**Figure 3.11 :** The viability of MCF-7 microtissues at 0 mM RGD concentration (Green: Living Cells Red: Dead Cells).

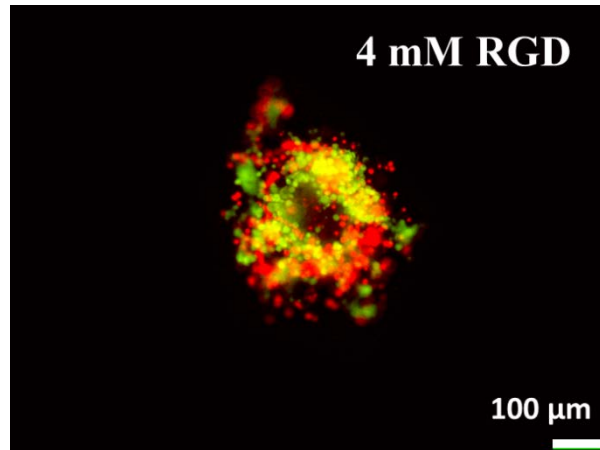
Highest living cell ratio was observed in 0 mM RGD concentration as surveyed in Figure 3.8.



**Figure 3.12 :** The viability of MCF-7 microtissues at 2 mM RGD concentration (Green: Living Cells Red: Dead Cells).

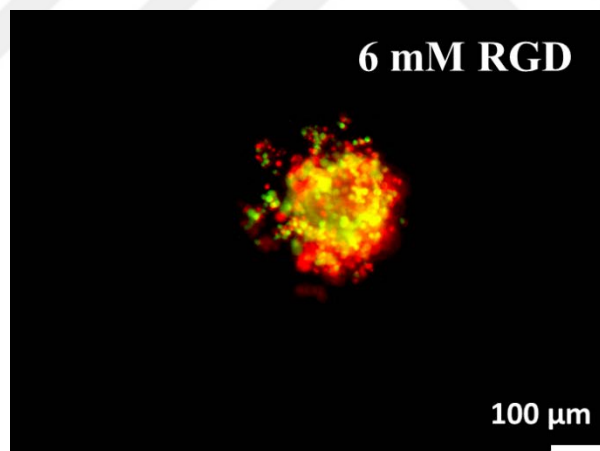
At 2 mM RGD concentration the ratio of living cells decreased when compared to 0 mM RGD. However, the ratio of live cells is almost the same as the ratio of dead cells.





**Figure 3.13 :** The viability of MCF-7 microtissues at 4 mM RGD concentration (Green: Living Cells Red: Dead Cells).

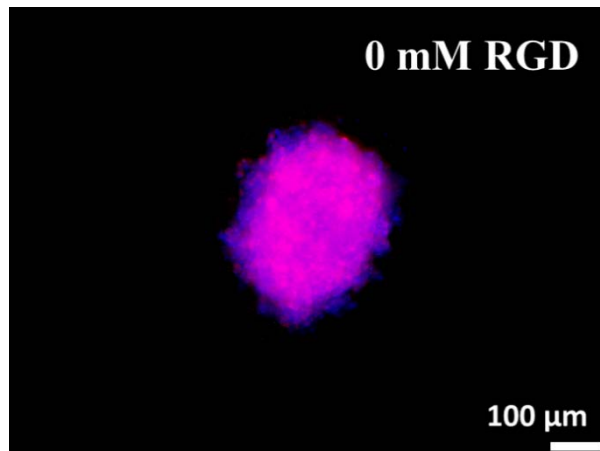
At 4 mM RGD concentration the ratio of dead cells decreased when compared to 0 mM RGD and 2 mM RGD. However lowest ratio of living cells observed at 6 mM RGD concentration. This results indicates the ratio of dead cells increase while increasing RGD concentration.



**Figure 3.14 :** The viability of MCF-7 microtissues at 6 mM RGD concentration (Green: Living Cells Red: Dead Cells).

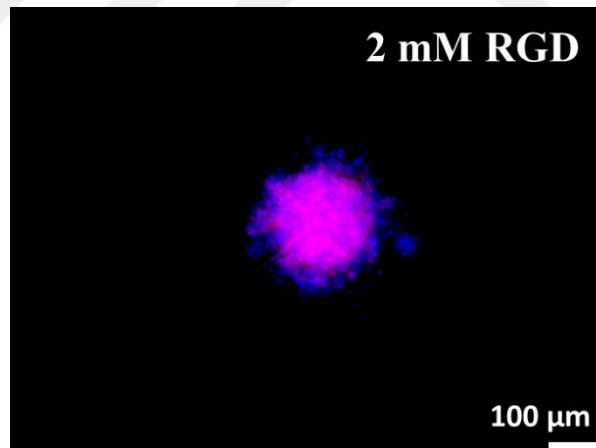
Focal adhesion dye was done to identify actin skeleton and determine the location of cells in microtissues. The experiment was realized triplicate and micrographs were

taken three different microtissue at 7th day in 100  $\mu\text{m}$  scale bar. All groups formed microtissues.

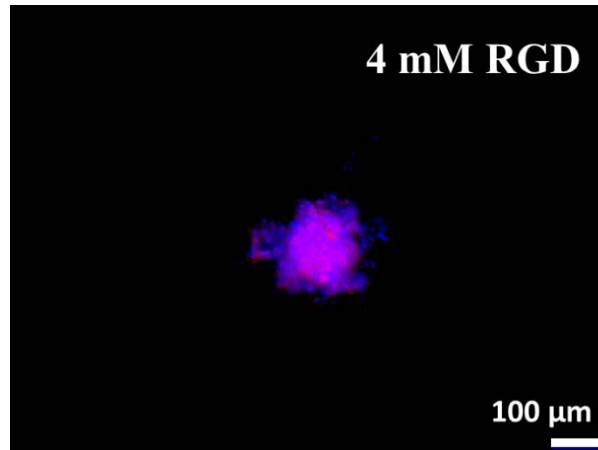


**Figure 3.15 :** Actin filament & Nucleus dye at 0 mM RGD concentration (Red: Actin Filament, Blue: Nucleus).

Density of actin filaments were highest at 0 mM RGD concentration and the density decreased at 2 mM RGD concentration.

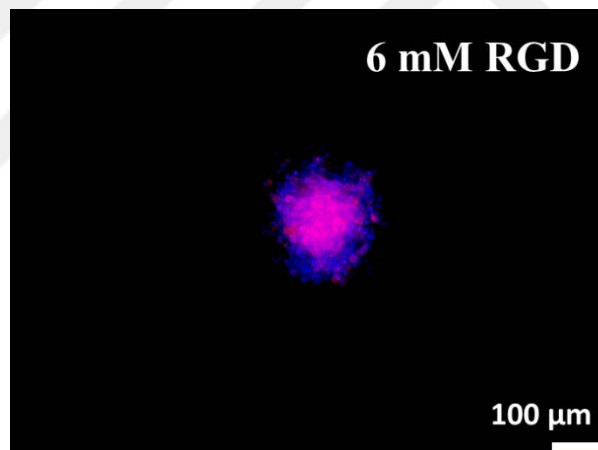


**Figure 3.16 :** Actin filament & Nucleus dye at 2 mM RGD concentration (Red: Actin Filament, Blue: Nucleus).



**Figure 3.17:** Actin filament & Nucleus dye at 4 mM RGD concentration (Red: Actin Flament, Blue: Nucleus).

Actin filament density was lowest at the 4 mM and 6 mM RGD concentrations. The density of actin filament and nucleus of cell are decreased with the size of microtissue.



**Figure 3.18:** Actin filament & Nucleus dye at 6 mM RGD concentration (Red: Actin Flament, Blue: Nucleus).

#### 4. DISCUSSION

Breast cancer, which is 23% more common in women than other types of cancer in the world, is one of the most critical diseases with a mortality rate of 14% today, very intensive studies are being carried out to discover novel, specific, active and less potent drug or chemical agent in cancer studies. Despite significant advances in diagnosis and treatment, mortality rates have increased over the years, suggesting that breast cancer is still an essential life-threatening type of cancer [75].

The goal of many chemotherapeutics is uncontrolled and rapidly growing cancerous cells, especially destroying and destroying them during proliferation. Despite significant positive developments in chemotherapeutic treatments applied to patients, in some cases, these drugs adversely affect healthy cells and cause severe tissue damage, and thus many healthy vital organs in the patient are adversely affected during treatment. Drug resistance is the most important of these side effects. Some anti-cancer medicines cause the body to be repressed on the immune system, leaving the body vulnerable. Some of these chemotherapeutics have unwanted side effects [76]. For this reason, patients treated with antioxidant substances that will reduce the reactive oxygen species (ROS) levels with the drugs they use in their treatment are one of the treatment modalities and strengthen the defence mechanism. Studies indicate that such combined treatments prevent tumors and reduce side effects to a minimum [77].

For this purpose, there are other attempts to deal with breast cancer. Fan and et al. worked on RGD as a delivery vector because of its antitumor activity. They aim to E-cadherin/catenin complex because of its importance for cancer cell migration and invasion. RGD (Arg-Gly-Asp) and NGR (Asn-Gly-Arg) sequences used for their properties for tumor targeting and apoptosis-inducing. They also used HAV (Histidine-Alanine-Valine) for its inhibition of cadherin-based functions. They merged these peptides into the biofunctional peptide (AVPIAQK) with enhanced tumor targeting and apoptosis effects. Their work's results have been promising results in *in-vivo*, and it might be used in pulmonary carcinoma therapy [78].

Chatterjee and et al. worked on human prostate cancer cells. They used cyclic RGD (Arg-Gly-Asp) peptides which are cyclo-(Arg-Gly-Asp-D-Phe-Val; cRGDfV), RGD and RGD-Ser on LNCaP and PC-3. They found cyclic RGD have significant killing

effect with almost 84% on human prostate cancer cells. Also, they showed the target for cyclic RGD which is  $\alpha\beta3$  integrins on the surface. This finding is evidence of caspase-3 and caspase-9. Eventually, their work suggests that cRGDfV might be a treatment for some human prostate cancer cells [79]. From Fan's and Chatterjee's studies we can predict one of the reasons for the antitumor effects of RGD that we observed might be related to integrin relation by blocking them.

Anuradha and et al. studied human leukemia (HL-60) cells with RGD peptides. They failed to induce apoptosis directly with RGD peptides on HL-60 cells. However, RGD-treated cells have shown internucleosomal DNA fragmentation. After the western blot testing, they found that a caspase-3 inhibitor z-VAD-FMK completely blocked the apoptosis, but caspase-1 inhibitor (Ac-YVAD-CMK) and caspase-2 inhibitor (z-VDVAD-FMK) did not block the apoptosis. These results also underline the importance of caspase-3 and give hints for future researches on RGD peptides mechanism [73].

Capello and et al. studied RGD-Linked somatostatin analogues. RGD, RGD-DTPA-octreotate, DTPA-RGD, and DTPA-Tyr3-octreotate was used. They found that RGD-DTPA-octreotate's effect was higher than other because of increased apoptosis by increased caspase-3 activity. They conclude that RGD peptides can be bind to somatostatin analogues which can increase the effect of peptides [80]. Anuradha and Capello showed another pathway for antitumor effect of RGD by inducing apoptosis via caspase-3.

Pei and et al., worked on melanoma differentiation-associated gene-7 (mda-7 / interleukin-24 (IL-24) because it is a cancer-specific, growth suppressing and an apoptosis-inducing gene with broad-spectrum antitumor activity. However, the capacity of it was low, so they enhanced with directly RGD via binding on integrin  $\alpha\beta3$ . They construct RGD-IL-24 which can express the RGD-MDA-7/IL-24 protein. They tested it on MCF-7, HeLa, HepG2 and normal human lung fibroblast cells. Findings of this study were revealed that peptide only induced apoptosis on tumor cells, not in healthy cells. Also, it significantly increased the ratio of pro-apoptotic (Bax) to anti-apoptotic (BCL-2) proteins in tumor cells but not in the healthy cells. All

above the study suggest that RGD-IL-24 might be used in tumor therapy by enhancing apoptosis [81].

RGD peptide is not only used for cancer cells. Teraha and et al. found that RGD-containing peptides induce apoptosis in hemocytes of the *Crassostrea gigas* (Pacific oyster). They observed typical characteristics of apoptosis-like chromatin condensation and distinctive DNA ladder on agarose gel electrophoresis. However, their research does not explain the exact mechanism of RGD on vertebras. Further researches based on this work might help us understand the mechanism of RGD on apoptosis [82].

Erhardt and et al. directly worked on activation of caspase-3 in rat cardiomyocytes by RGD peptides. All observations conclude that caspase-3/caspase-7 cleavage occurred only RGD-treated cells. Similar results obtained in T cells and other leukocytic cell types. In all studies RGD induced cell death and caspase activation through direct activation of caspase-3. However, the exact concentration was unclear for the apoptotic effect in this study for particular cell types. In order to better understanding, future researches have to enlighten the effects of RGD doses and different molecular structures of RGD compounds. On the other hand, this study suggests that activation of caspase may not be the only mechanism that triggers mortality in different cells [83].

Chen did another major study with collages. They successfully inhibit tumor growth with RGD-Tachyplesin complex. Tachyplesin is an antimicrobial peptide that found in the horseshoe crab's (*Tachypleus tridentatus*) leukocytes. They conjugated RGD with the synthetic tachyplesin. Their results demonstrated that RGD-tachyplesin hindered the expansion of both tumor and endothelial cells and decreased the colony formation of TSU prostate cancer cells *in vitro*. Also, they think that the complex induces apoptosis since the western-blotting showed caspase 9, caspase 8 and caspase 3. On the other expression of Fas ligand, Fas-associated death domain, caspase 7 and caspase 6 increased. These results suggest that the complex could use both mitochondrial and Fas-dependent pathways to induce apoptosis. To sum up, this complex can be used as an antitumor agent [84]. We can understand that RGD might not induce only caspase-3, it might induce other caspase pathways for apoptosis.

As mentioned above, RGD is not using only for cancer; there are other diseases like fibrosis that RGD modification increases the apoptosis treatment. Jamhiri and et al. used RGD for modification of Interleukin-24/melanoma differentiation-associated gene-7 (IL-24/mda-7) for enhancing apoptosis on human hepatic stellate cells (HSCs). IL-24/mda-7 is a cytokine that is used for tumor killing as well as the pathophysiology of the diseases. Real-time PCR and viability assessments showed that complex had the most significant growth inhibitory effect. Statistically compared with the control group the p-value is equal to 0.0002. So, this result indicates that RGD-modified IL-24/mda-7 might be a suitable candidate for the treatment of fibrosis [85].

The il-24/mda-7 complex is used on carcinoma cells too. Hosseini and et al. tried the same RGD-IL-24/mda-7 complex on the hepatocellular carcinoma cell line (HepG2) and human liver stellate cell line (LX-2). The results of enzyme-linked immunosorbent assay (ELISA), qPCR and propidium iodide (PI)/ annexin V-APC staining also known as apoptosis analysis showed that HepG2 has significant difference compared with the control group. On the other hand, LX-2 has no significant difference which means the modified complex (SP RGD-IL-24) or native IL-24 they used did not induce apoptosis. Results are promising for further studies [86].

Bina and et al. made a similar study with different RGD complex on HepG2. They fused plasmids producing mda-7 with different RGD complexes which are full RGD4C, shortened RGD and tRGD. However, results of RGD4C and shortened RGD decrease apoptosis. Furthermore, these complexes also disrupt receptor attachment. They demonstrated this by protein modelling. The mechanisms of RGD complexes unclear and the tethering of targeting peptide to mda-7 or other cytokines will not always get a better response. For more better results, different kind of complexes must be tested [87].

Previous studies have been done before used RGD to increase the efficiency of their molecules. However, some groups used RGD as targeting molecule too [88]. Our aim understood the single uncomplicated RGD peptide's effect on the breast cancer cell line. Our size analysis results significantly gave a positive difference after the 4th day. On the other hand, increased concentration of RGD (6 mMol) has shown a remarkable difference between the control group. At the end of the assay, the viability of MCF-7

increased by increasing of RGD concentration. Furthermore, understanding the structure of the microtissues actin filament & nucleus dye have done. This assay's results showed us even in increased concentrations cells formed microtissues, but the size reduction is given promising results for future studies.





## 5. CONCLUSION

In the present study, RGD peptide at concentrations of 2 mM, 4mM and 6 mM were exposed to tumor microtissues to evaluate the anticancer effect of the RGD. Increased RGD concentration was significantly reduced tumor size and the ratio of living cancer cells. This results indicated that RGD has an antitumor effect. RGD peptide has promising results for tumor treatment because of its antitumor property. Also, studies have done for its usage of the target molecule for other drugs and given results shown that positive effect . Results of this study proved and supported the previous studies [73; 79; 80]. It can be concluded that RGD is not only important for cancer treatment but also it can be used for other diseases. Previous studies showed that RGD binds to integrins which then might affect tumor cell adhesion and migration [74]. In the present study, we can speculate that such binding might prevent angiogenesis during tumor development. On the other hand, recent studies in the literature indicate that, RGD induces apoptosis and which could be considered as another mechanism for the antitumor effect of RGD. All the above might occurred alone or together for its antitumor effect that we observed in our study. However, the mechanisms of RGD peptides or complexes must be well understood for a noticeable effect on treatments. Although, it is clear that RGD peptides are a good candidate for tumor treatment as well as treatment of other diseases.

## REFERENCES

- [1] Zuppinger, C. (2016). 3D culture for cardiac cells. *Biochimica et Biophysica Acta (BBA) - Molecular Cell Research*, 1863(7, Part B), 1873-1881. doi:<https://doi.org/10.1016/j.bbamcr.2015.11.036>
- [2] Günter, J., Wolint, P., Bopp, A., Steiger, J., Cambria, E., Hoerstrup, S. P., & Emmert, M. Y. (2016). Microtissues in Cardiovascular Medicine: Regenerative Potential Based on a 3D Microenvironment. *Stem Cells International*, 2016, 20. doi:10.1155/2016/9098523
- [3] Bhang, S. H., Lee, S., Lee, T.-J., La, W.-G., Yang, H.-S., Cho, S.-W., & Kim, B.-S. (2012). Three-Dimensional Cell Grafting Enhances the Angiogenic Efficacy of Human Umbilical Vein Endothelial Cells. *Tissue Engineering Part A*, 18(3-4), 310-319. doi:10.1089/ten.tea.2011.0193
- [4] Haycock, J. W. (2011). 3D Cell Culture: A Review of Current Approaches and Techniques. In J. W. Haycock (Ed.), *3D Cell Culture: Methods and Protocols* (pp. 1-15). Totowa, NJ: Humana Press.
- [5] Sasaki, J.-I., Hashimoto, M., Yamaguchi, S., Itoh, Y., Yoshimoto, I., Matsumoto, T., & Imazato, S. (2015). Fabrication of Biomimetic Bone Tissue Using Mesenchymal Stem Cell-Derived Three-Dimensional Constructs Incorporating Endothelial Cells. *PLOS ONE*, 10(6), e0129266. doi:10.1371/journal.pone.0129266
- [6] Kabadi, P. K., Vantangoli, M. M., Rodd, A. L., Leary, E., Madnick, S. J., Morgan, J. R., . . . Boekelheide, K. (2015). Into the depths: Techniques for in vitro three-dimensional microtissue visualization. *BioTechniques*, 59(5), 279-286. doi:10.2144/000114353
- [7] Dissanayaka, W. L., Zhu, L., Hargreaves, K. M., Jin, L., & Zhang, C. (2015). In Vitro Analysis of Scaffold-free Prevascularized Microtissue Spheroids Containing Human Dental Pulp Cells and Endothelial Cells. *Journal of Endodontics*, 41(5), 663-670. doi:10.1016/j.joen.2014.12.017
- [8] Wobma, H., & Vunjak-Novakovic, G. (2016). Tissue Engineering and Regenerative Medicine 2015: A Year in Review. *Tissue Engineering. Part B, Reviews*, 22(2), 101-113. doi:10.1089/ten.teb.2015.0535
- [9] Saleh, F., Whyte, M., & Genever, P. (2011). *Effects of endothelial cells on human mesenchymal stem cell activity in a three-dimensional in vitro model* (Vol. 22).
- [10] Sala, A., Hanseler, P., Ranga, A., Lutolf, M. P., Voros, J., Ehrbar, M., & Weber, F. E. (2011). Engineering 3D cell instructive microenvironments by rational assembly of artificial extracellular matrices and cell patterning. *Integr Biol (Camb)*, 3(11), 1102-1111. doi:10.1039/c1ib00045d
- [11] Tung, Y.-C., Hsiao, A. Y., Allen, S. G., Torisawa, Y.-s., Ho, M., & Takayama, S. (2011). High-throughput 3D spheroid culture and drug testing using a 384 hanging drop array. *Analyst*, 136(3), 473-478. doi:10.1039/C0AN00609B
- [12] Kelm, J. M., & Fussenegger, M. (2010). Scaffold-free cell delivery for use in regenerative medicine. *Advanced Drug Delivery Reviews*, 62(7), 753-764. doi:<https://doi.org/10.1016/j.addr.2010.02.003>

- [13] Barbone, D., Yang, T.-M., Morgan, J. R., Gaudino, G., & Broaddus, V. C. (2008). Mammalian Target of Rapamycin Contributes to the Acquired Apoptotic Resistance of Human Mesothelioma Multicellular Spheroids. *The Journal of Biological Chemistry*, 283(19), 13021-13030. doi:10.1074/jbc.M709698200
- [14] Lavik, E., & Langer, R. (2004). Tissue engineering: current state and perspectives. *Applied microbiology and biotechnology*, 65(1), 1-8.
- [15] Pampaloni, F., Reynaud, E. G., & Stelzer, E. H. (2007). The third dimension bridges the gap between cell culture and live tissue. *Nature reviews Molecular cell biology*, 8(10), 839.
- [16] Hadjantonakis, A.-K., Dickinson, M. E., Fraser, S. E., & Papaioannou, V. E. (2003). Technicolour transgenics: imaging tools for functional genomics in the mouse. *Nature Reviews Genetics*, 4(8), 613.
- [17] Ghosh, M. M., Boyce, S., Layton, C., Freedlander, E., & Mac Neil, S. (1997). A comparison of methodologies for the preparation of human epidermal-dermal composites. *Ann Plast Surg*, 39(4), 390-404.
- [18] Griffith, L. G., & Swartz, M. A. (2006). Capturing complex 3D tissue physiology in vitro. *Nat Rev Mol Cell Biol*, 7(3), 211-224. doi:10.1038/nrm1858
- [19] O'Brien, F. J., Harley, B. A., Yannas, I. V., & Gibson, L. J. (2005). The effect of pore size on cell adhesion in collagen-GAG scaffolds. *Biomaterials*, 26(4), 433-441. doi:10.1016/j.biomaterials.2004.02.052
- [20] Zhou, Y., Hutmacher, D. W., Varawan, S.-L., & Lim, T. M. (2006). Effect of Collagen-I Modified Composites on Proliferation and Differentiation of Human Alveolar Osteoblasts. *Australian Journal of Chemistry*, 59(8), 571-578. doi:<https://doi.org/10.1071/CH06165>
- [21] Lee, C. H., Singla, A., & Lee, Y. (2001). Biomedical applications of collagen. *Int J Pharm*, 221(1-2), 1-22.
- [22] Zhong, S. P., Teo, W. E., Zhu, X., Beuerman, R., Ramakrishna, S., & Yung, L. Y. L. (2007). Development of a novel collagen-GAG nanofibrous scaffold via electrospinning. *Materials Science and Engineering: C*, 27(2), 262-266. doi:<https://doi.org/10.1016/j.msec.2006.05.010>
- [23] Duarte, M. L., Ferreira, M. C., Marvão, M. R., & Rocha, J. (2001). Determination of the degree of acetylation of chitin materials by <sup>13</sup>C CP/MAS NMR spectroscopy. *International Journal of Biological Macromolecules*, 28(5), 359-363. doi:[https://doi.org/10.1016/S0141-8130\(01\)00134-9](https://doi.org/10.1016/S0141-8130(01)00134-9)
- [24] Birk, D. E., Lande, M. A., & Fernandez-Madrid, F. R. (1981). Collagen and glycosaminoglycan synthesis in aging human keratocyte cultures. *Experimental Eye Research*, 32(3), 331-339. doi:[https://doi.org/10.1016/0014-4835\(81\)90038-5](https://doi.org/10.1016/0014-4835(81)90038-5)
- [25] Motta, A., Fambri, L., & Migliaresi, C. (2002). Regenerated silk fibroin films: Thermal and dynamic mechanical analysis. *Macromolecular Chemistry and Physics*, 203(10-11), 1658-1665. doi:doi:10.1002/1521-3935(200207)203:10/11<1658::AID-MACP1658>3.0.CO;2-3
- [26] Rahfoth, B., Weisser, J., Sternkopf, F., Aigner, T., von der Mark, K., & Bräuer, R. (1998). Transplantation of allograft chondrocytes embedded in agarose gel

- into cartilage defects of rabbits. *Osteoarthritis and Cartilage*, 6(1), 50-65.  
doi:10.1053/joca.1997.0092
- [27] Orive, G., Maria Hernández, R., Rodríguez Gascón, A., Calafiore, R., Swi Chang, T. M., Vos, P. d., . . . Luis Pedraz, J. (2004). History, challenges and perspectives of cell microencapsulation. *Trends in Biotechnology*, 22(2), 87-92. doi:<https://doi.org/10.1016/j.tibtech.2003.11.004>
- [28] Kaur, L., Singh, J., & Liu, Q. (2007). Starch – A Potential Biomaterial for Biomedical Applications. In M. R. Mozafari (Ed.), *Nanomaterials and Nanosystems for Biomedical Applications* (pp. 83-98). Dordrecht: Springer Netherlands.
- [29] Gunatillake, P. A., & Adhikari, R. (2003). Biodegradable synthetic polymers for tissue engineering. *Eur Cell Mater*, 5, 1-16; discussion 16.
- [30] Yang, F., Cui, W., Xiong, Z., Liu, L., Bei, J., & Wang, S. (2006). Poly(1,1-lactide-co-glycolide)/tricalcium phosphate composite scaffold and its various changes during degradation in vitro. *Polymer Degradation and Stability*, 91(12), 3065-3073.  
doi:<https://doi.org/10.1016/j.polymdegradstab.2006.08.008>
- [31] Schieker, M., Seitz, H., Drosse, I., Seitz, S., & Mutschler, W. (2006). Biomaterials as Scaffold for Bone Tissue Engineering. *European Journal of Trauma*, 32(2), 114-124. doi:10.1007/s00068-006-6047-8
- [32] Böstman, O., Partio, E., Hirvensalo, E., & Rokkanen, P. (1992). Foreign-body reactions to polyglycolide screws. *Acta Orthopaedica Scandinavica*, 63(2), 173-176. doi:10.3109/17453679209154817
- [33] Jenkins, M. J., & Harrison, K. L. (2008). The effect of crystalline morphology on the degradation of polycaprolactone in a solution of phosphate buffer and lipase. *Polymers for Advanced Technologies*, 19(12), 1901-1906.  
doi:doi:10.1002/pat.1227
- [34] McDevitt, T. C., Woodhouse, K. A., Hauschka, S. D., Murry, C. E., & Stayton, P. S. (2003). Spatially organized layers of cardiomyocytes on biodegradable polyurethane films for myocardial repair. *Journal of Biomedical Materials Research Part A*, 66A(3), 586-595. doi:doi:10.1002/jbm.a.10504
- [35] Andriano, K. P., Tabata, Y., Ikada, Y., & Heller, J. (1999). In vitro and in vivo comparison of bulk and surface hydrolysis in absorbable polymer scaffolds for tissue engineering. *Journal of Biomedical Materials Research*, 48(5), 602-612. doi:doi:10.1002/(SICI)1097-4636(1999)48:5<602::AID-JBM3>3.0.CO;2-6
- [36] Chasin, M. (1990). *Biodegradable polymers as drug delivery systems* (Vol. 45): Informa Health Care.
- [37] Hamamoto, R., Yamada, K., Kamihira, M., & Iijima, S. (1998). Differentiation and Proliferation of Primary Rat Hepatocytes Cultured as Spheroids1. *The Journal of Biochemistry*, 124(5), 972-979.  
doi:10.1093/oxfordjournals.jbchem.a022215
- [38] Achilli, T.-M., McCalla, S., Tripathi, A., & Morgan, J. R. (2012). Quantification of the Kinetics and Extent of Self-Sorting in Three Dimensional Spheroids. *Tissue Engineering Part C: Methods*, 18(4), 302-309.  
doi:10.1089/ten.tec.2011.0478

- [39] Foty, R. (2011). A Simple Hanging Drop Cell Culture Protocol for Generation of 3D Spheroids. *Journal of Visualized Experiments : JoVE*(51), 2720. doi:10.3791/2720
- [40] He, J., Xiong, L., Li, Q., Lin, L., Miao, X., Yan, S., . . . Deng, X. (2018). 3D modeling of cancer stem cell niche. *Oncotarget*, 9(1), 1326.
- [41] Wan, C.-r., Chung, S., & Kamm, R. D. (2011). Differentiation of embryonic stem cells into cardiomyocytes in a compliant microfluidic system. *Annals of biomedical engineering*, 39(6), 1840-1847.
- [42] Vogel, V., & Baneyx, G. (2003). The tissue engineering puzzle: a molecular perspective. *Annual review of biomedical engineering*, 5(1), 441-463.
- [43] Rosa, V., Zhang, Z., Grande, R., & Nör, J. (2013). Dental pulp tissue engineering in full-length human root canals. *Journal of dental research*, 92(11), 970-975.
- [44] Kelm, J. M., & Fussenegger, M. (2004). Microscale tissue engineering using gravity-enforced cell assembly. *Trends in Biotechnology*, 22(4), 195-202.
- [45] Kelm, J. M., Djonov, V., Ittner, L. M., Fluri, D., Born, W., Hoerstrup, S. P., & Fussenegger, M. (2006). Design of custom-shaped vascularized tissues using microtissue spheroids as minimal building units. *Tissue engineering*, 12(8), 2151-2160.
- [46] Karimi, P., Shahrokni, A., & Ranjbar, M. (2014). Implementation of proteomics for cancer research: past, present, and future. *Asian Pac J Cancer Prev*, 15(6), 2433-2438.
- [47] Ponraj, T., Paulpandi, M., Vivek, R., Vimala, K., & Kannan, S. (2017). Protein regulation and Apoptotic induction in human breast carcinoma cells (MCF-7) through lectin from *G. beatus*. *International Journal of Biological Macromolecules*, 95, 1235-1245.
- [48] Azzopardi, J., Chepick, O., Hartmann, W., Jafarey, N., Llombart-Bosch, A., Ozzello, L., . . . Sommers, S. (1982). The World Health Organization histological typing of breast tumors—Second edition. *American Journal of Clinical Pathology*, 78(6), 806-816.
- [49] Holliday, D. L., & Speirs, V. (2011). Choosing the right cell line for breast cancer research. *Breast Cancer Research : BCR*, 13(4), 215-215. doi:10.1186/bcr2889
- [50] Lee, A. V., Oesterreich, S., & Davidson, N. E. (2015). MCF-7 Cells—Changing the Course of Breast Cancer Research and Care for 45 Years. *JNCI: Journal of the National Cancer Institute*, 107(7), djv073-djv073. doi:10.1093/jnci/djv073
- [51] Lee, J., Cuddihy, M. J., Cater, G. M., & Kotov, N. A. (2009). Engineering liver tissue spheroids with inverted colloidal crystal scaffolds. *Biomaterials*, 30(27), 4687-4694.
- [52] Cheng, J., & Deming, T. J. (2011). Synthesis of polypeptides by ring-opening polymerization of  $\alpha$ -amino acid N-carboxyanhydrides. In *Peptide-based materials* (pp. 1-26): Springer.
- [53] Genové, E., Shen, C., Zhang, S., & Semino, C. E. (2005). The effect of functionalized self-assembling peptide scaffolds on human aortic endothelial cell function. *Biomaterials*, 26(16), 3341-3351.

- [54] Maude, S., Tai, L., Davies, R., Liu, B., Harris, S., Kocienski, P., & Aggeli, A. (2011). Peptide synthesis and self-assembly. In *Peptide-Based Materials* (pp. 27-69): Springer.
- [55] Sewald, N., & Jakubke, H.-D. (2015). *Peptides: chemistry and biology*: John Wiley & Sons.
- [56] Behrendt, R., White, P., & Offer, J. (2016). Advances in Fmoc solid-phase peptide synthesis. *Journal of Peptide Science*, 22(1), 4-27.
- [57] Sheppard, R. (2003). The fluorenylmethoxycarbonyl group in solid phase synthesis. *Journal of peptide science: an official publication of the European Peptide Society*, 9(9), 545-552.
- [58] Shin, H., Jo, S., & Mikos, A. G. (2003). Biomimetic materials for tissue engineering. *Biomaterials*, 24(24), 4353-4364.
- [59] Bellis, S. L. (2011). Advantages of RGD peptides for directing cell association with biomaterials. *Biomaterials*, 32(18), 4205-4210.
- [60] Siegwart, D. J., Oh, J. K., Gao, H., Bencherif, S. A., Perineau, F., Bohaty, A. K., . . . Matyjaszewski, K. (2008). Biotin-, Pyrene-, and GRGDS-Functionalized Polymers and Nanogels via ATRP and End Group Modification. *Macromolecular Chemistry and Physics*, 209(21), 2179-2193.
- [61] Dunehee, A. L., Anderson, M., Majumdar, S., Kobayashi, N., Berklund, C., & Siahaan, T. J. (2006). Cell adhesion molecules for targeted drug delivery. *Journal of pharmaceutical sciences*, 95(9), 1856-1872.
- [62] Arnaout, M., Mahalingam, B., & Xiong, J.-P. (2005). Integrin structure, allostery, and bidirectional signaling. *Annu. Rev. Cell Dev. Biol.*, 21, 381-410.
- [63] Buckley, C. D., Pilling, D., Henriquez, N. V., Parsonage, G., Threlfall, K., Scheel-Toellner, D., . . . Salmon, M. (1999). RGD peptides induce apoptosis by direct caspase-3 activation. *Nature*, 397(6719), 534.
- [64] Alles, A., Alley, K., Barrett, J., Buttyan, R., Columbano, A., Cope, F., . . . Gershenson, L. (1991). Apoptosis: a general comment. *The FASEB journal*, 5(8), 2127-2128.
- [65] Kaya, C., Çalışkan, Y., & Yönden, Z. APOPTOZİS. *Mustafa Kemal Üniversitesi Tıp Dergisi*, 3(11), 26-37.
- [66] Krajewski, S., Krajewska, M., Ellerby, L. M., Welsh, K., Xie, Z., Deveraux, Q. L., . . . Fiskus, G. (1999). Release of caspase-9 from mitochondria during neuronal apoptosis and cerebral ischemia. *Proceedings of the National Academy of Sciences*, 96(10), 5752-5757.
- [67] Bell, B. D., Leverrier, S., Weist, B. M., Newton, R. H., Arechiga, A. F., Luhrs, K. A., . . . Walsh, C. M. (2008). FADD and caspase-8 control the outcome of autophagic signaling in proliferating T cells. *Proceedings of the National Academy of Sciences*, 105(43), 16677-16682.
- [68] Yu, L., Lenardo, M. J., & Baehrecke, E. H. (2004). Autophagy and caspases: a new cell death program. *Cell cycle*, 3(9), 1122-1124.
- [69] Qian, W., Liu, J., Jin, J., Ni, W., & Xu, W. (2007). Arsenic trioxide induces not only apoptosis but also autophagic cell death in leukemia cell lines via up-regulation of Beclin-1. *Leukemia research*, 31(3), 329-339.
- [70] Yarali, Z., & Karaman, O. (2017). *Effect of Soluble RGD Peptide on Vasculogenesis of Scaffold-Free Micro-Tissues*. Paper presented at the Tissue Engineering Part A.

- [71] Kang, I. C., Kim, D. S., Jang, Y., & Chung, K. H. (2000). Suppressive mechanism of salmosin, a novel disintegrin in B16 melanoma cell metastasis. *Biochem Biophys Res Commun*, 275(1), 169-173. doi:10.1006/bbrc.2000.3130
- [72] Mitjans, F., Meyer, T., Fittschen, C., Goodman, S., Jonczyk, A., Marshall, J. F., . . . Piulats, J. (2000). In vivo therapy of malignant melanoma by means of antagonists of alphav integrins. *Int J Cancer*, 87(5), 716-723.
- [73] Anuradha, C., Kanno, S., & Hirano, S. (2000). RGD peptide-induced apoptosis in human leukemia HL-60 cells requires caspase-3 activation. *Cell biology and toxicology*, 16(5), 275-283.
- [74] Eliceiri, B. P., & Cheresh, D. A. (1999). The role of alphav integrins during angiogenesis: insights into potential mechanisms of action and clinical development. *J Clin Invest*, 103(9), 1227-1230. doi:10.1172/jci6869
- [75] Jemal, A., Bray, F., Center, M. M., Ferlay, J., Ward, E., & Forman, D. (2011). Global cancer statistics. *CA: a cancer journal for clinicians*, 61(2), 69-90.
- [76] Aitken, R. J., & Roman, S. D. (2008). Antioxidant systems and oxidative stress in the testes. *Oxidative medicine and cellular longevity*, 1(1), 15-24.
- [77] Türk, G. (2013). Kemoterapötiklerin erkek üreme sistemi üzerindeki yan etkileri ve koruyucu stratejiler.
- [78] Fan, R., Mei, L., Gao, X., Wang, Y., Xiang, M., Zheng, Y., . . . Zhou, L. (2017). Self-Assembled Bifunctional Peptide as Effective Drug Delivery Vector with Powerful Antitumor Activity. *Advanced Science*, 4(4), 1600285.
- [79] Chatterjee, S., Brite, K. H., & Matsumura, A. (2001). Induction of apoptosis of integrin-expressing human prostate cancer cells by cyclic Arg-Gly-Asp peptides. *Clinical cancer research*, 7(10), 3006-3011.
- [80] Capello, A., Krenning, E. P., Bernard, B. F., Breeman, W. A., Van Hagen, M. P., & De Jong, M. (2004). Increased cell death after therapy with an Arg-Gly-Asp-linked somatostatin analog. *Journal of Nuclear Medicine*, 45(10), 1716-1720.
- [81] Pei, D.-S., Yang, Z.-X., Zhang, B.-F., Yin, X.-X., Li, L.-T., Li, H.-Z., & Zheng, J.-N. (2012). Enhanced apoptosis-inducing function of MDA-7/IL-24 RGD mutant via the increased adhesion to tumor cells. *Journal of Interferon & Cytokine Research*, 32(2), 66-73.
- [82] Terahara, K., Takahashi, K. G., & Mori, K. (2003). Apoptosis by RGD-containing peptides observed in hemocytes of the Pacific oyster, *Crassostrea gigas*. *Developmental & Comparative Immunology*, 27(6-7), 521-528.
- [83] Erhardt, J. A., Ohlstein, E. H., Toomey, J. R., Gabriel, M. A., Willette, R. N., Yue, T.-L., . . . Parsons, A. A. (2001). Activation of caspase-3/caspase-3-like activity in rat cardiomyocytes by an RGD peptide, but not the GPIIb/IIIa antagonist lotrafiban. *Thrombosis research*, 103(2), 143-148.
- [84] Chen, Y., Xu, X., Hong, S., Chen, J., Liu, N., Underhill, C. B., . . . Zhang, L. (2001). RGD-Tachyplesin inhibits tumor growth. *Cancer research*, 61(6), 2434-2438.
- [85] Jamhiri, I., Zahri, S., Mehrabani, D., Khodabandeh, Z., Dianatpour, M., Yaghobi, R., & Hosseini, S. Y. (2018). Enhancing the apoptotic effect of IL-24/mda-7 on the human hepatic stellate cell through RGD peptide modification. *Immunological investigations*, 47(4), 335-350.

- [86] Hosseini, E., Hosseini, S. Y., Hashempour, T., Fattahi, M. R., & Sadeghizadeh, M. (2017). Effect of RGD coupled MDA-7/IL-24 on apoptosis induction in a hepatocellular carcinoma cell line. *Molecular medicine reports*, 15(1), 495-501.
- [87] Bina, S., Shenavar, F., Khodadad, M., Haghshenas, M. R., Mortazavi, M., Fattahi, M.-R., . . . Hosseini, S. Y. (2015). Impact of RGD peptide tethering to IL24/mda-7 (melanoma differentiation associated gene-7) on apoptosis induction in hepatocellular carcinoma cells. *Asian Pac J Cancer Prev*, 16(14), 6073-6080.
- [88] Yang, L., Li, W., Huang, Y., Zhou, Y., & Chen, T. (2015). Rational Design of Cancer-Targeted Benzoselenadiazole by RGD Peptide Functionalization for Cancer Theranostics. *Macromolecular rapid communications*, 36(17), 1559-1565.





## CURRICULUM VITAE



**Name Surname** : Veli Kaan AYDIN  
**Place and Date of Birth** : EDIRNE- 02/09/1993  
**E-Mail** : v.kaanaydin@gmail.com

### EDUCATION

- :
- **B.Sc.** : Ege University, Engineering Faculty, Bioengineering Department

### PROFESSIONAL EXPERIENCE AND REWARDS:

- 08/2015-09/2015 Zentiva Health Products Industry and Inc., Luleburgaz (Turkey)
- 08/2014-09/2014 Sabanci University Sezerman Laboratory - Bioinformatics, Istanbul (Turkey)
- 01/2014-07/2014 Ege University Animal Cell Culture and Tissue Engineering Laboratory, Izmir (Turkey)

### PUBLICATIONS, PRESENTATIONS AND PATENTS:

**V.K. Aydin**, M. Sen (2017), "A facile method for fabricating carbon fiber-based gold ultramicroelectrodes with different shapes using flame etching and electrochemical deposition", Journal of Electroanalytical Chemistry, Vol.799, 525-530.

**V.K. Aydin**, I. Kimiz, D. Ayyildiz-Tamis, S. Gulce-Iz (2016), "Human Follicle Derived Mesenchymal Origin Design of Fetus Medium for Stem Cells ", 16. Bioengineering Days, May 17-18, Izmir, Turkey (Poster Presentation)

S. Ozturk, **V.K. Aydin**, B. Karakuzu, A. Sendemir Urkmez (2015), "Consideration of cell behavior in three dimensional non-adhesive microenvironment", International Biomedical Engineering Congress 2015 (IBMEC' 2015), March 12-14, Kyrenia, North Cyprus (Poster Presentation)

S. Ozturk, **V.K. Aydin**, B. Karakuzu, A. Sendemir Urkmez (2014), "Investigation of cell localization in 3D micro tissues", 18. Biomedical Engineering National Meeting (BIOMUT), September 16-17, Istanbul, Turkey

S. Ozturk, **V.K. Aydin**, B. Karakuzu, A. Sendemir Urkmez (2014), "3D Culture Medium Investigation of Keratinocyte-Fibroblast Localization ", II. Bioengineering Student Congress, March 15-16, Izmir, Turkey (Second Place Award)

